



2022

PRICE LIST

PRICES DO NOT INCLUDE V.A.T.





1939



1950



1960



1970



1980

Beta — GROUP —



8 production
units



Almost
900 staff

11
Subsidiaries

Active in more than
100 countries
worldwide with over
250 importers



BETA UTENSILI S.p.A. - 20845 Sovico (MB)
Via A.Volta, 18 - Tel. 039.2077.1 - Fax 039.2010742
www.beta-tools.com

Robur Wire rope accessories:
67039 Sulmona (AQ) Zona industriale - C.da S. Nicola
Tel. 0864.2504.1 - Fax 0864.253132
www.roburitaly.com - info@roburitaly.com



1939 Forging department



2021 Sovico headquarters

INDEX



Index.....	4
Key reading.....	8
Fields of use for torque wrenches	57-58
Chart for containers and assortments	330, 427-428
Eliminated items – substitute/recommended items	652
Alphabetical index	656÷659
Index of car vehicle tools	660÷662
Alphanumeric index	663÷678
Logistics.....	679
Worldwide distribution.....	680
The history of Italian tools	681
Certified quality	682
Control and quality	683
Work organization	684
Effective presence	685

INDEX

WORKSHOP EQUIPMENT **RSC55**



RSC55

387÷411

WORKSHOP EQUIPMENT **C45PRO**



412÷426

CONTAINERS AND ASSORTMENTS



331÷345



346÷359



357÷386



427÷505

WRENCHES



11÷17

23÷27

109÷114

SOCKETS AND ACCESSORIES



69÷76

83÷109

TORQUE WRENCHES AND MULTIPLIERS



53÷55

56÷59

SCREWDRIVERS, MALE-END WRENCHES AND BITS



18÷23

76÷83

112÷114

142÷155

PLIERS AND NIPPERS



125÷131

137÷139

235

HAMMERS AND CHISELS



9-10

161÷165

218-219

DRILLING AND THREADING TOOLS



35÷40



41÷43



43÷50



50÷52

LIGHTING



241÷245

PULLERS



166-167



197÷207

REELS



246-247

MEASURING AND MARKING TOOLS



212÷220

PLUMBING TOOLS



27÷34

CUTTING AND GENERAL MAINTENANCE TOOLS



120-121

131÷135

154-155

182-183



208

220÷229



236÷239

247÷251

ELECTRONICS AND MICROMECHANICS



124-125

140÷142

145÷147

240-241

ELECTROTECHNICS



134÷137

146

209÷212

232÷235

1000V INSULATED TOOLS



278÷284

STAINLESS STEEL



292÷296

SPARKPROOF TOOLS



297÷305

VEHICLE REPAIR



114÷123

156÷161



165÷207

230÷235

WORKSHOP EQUIPMENT



251÷267

MOTORCYCLE TOOLS



268÷273

BICYCLE TOOLS



274÷277

BATTERY TOOLS



306

PNEUMATIC TOOLS AND ACCESSORIES



307÷329

TETHERED TOOLS



285÷291

CHEMICAL PRODUCTS



506÷511

SAFETY FOOTWEAR (AND TECHNICAL SOCKS)



562÷586

ABRASIVE TOOLS



512÷528

WORKWEAR



587÷602

PRODUCTS UNDER THE BRAND NAME BM



529÷534

BLISTER PACK RANGE



535÷548

ROBUR WIRE ROPE ACCESSORIES



603÷640

DISPLAY UNITS FOR SALES POINTS



549÷561

BETA COLLECTION



641÷651

KEY READING

item number **42**

combination wrenches

Torque values more than doubled compared to the requirements to be satisfied under ISO 1711

tool profile 

price

size

n.° of tools per box

n.° of tools per set

type of packaging

set content

code number

new item 2022

in blister pack 

motorcycle tools 

bicycle tools 

DIN 3113 UNI-ISO 7738

mm	L mm	S1 mm	€	1	1
5,5x5,5	95	3,4	7,35	5	000421005
6x6	95	3,4	7,45	5	000421006
7x7	105	3,6	7,50	5	000421007
8x8	116	3,9	7,65	5	000421008
9x9	127	4,2	8,15	5	000421009
10x10	137	4,5	8,35	5	000421010
11x11	148	4,8	8,95	5	000421011
12x12	158	5,1	9,15	5	000421012
13x13	169	5,6	9,20	5	000421013
14x14	180	5,7	10,50	5	000421014
15x15	190	6,0	11,50	5	000421015
16x16	201	6,3	11,90	5	000421016
17x17	212	6,8	12,60	5	000421017
18x18	222	7,0	13,30	5	000421018
19x19	233	7,5	13,70	5	000421019

42/B9N € 95,50 1 000421074

2002/BV9 € 9,65 1 020020030

Most used symbols

Sets

	Example
B	42/B9N
BV	2002/BV9
C	900/C11
D	1293/D6
S	42/S17
SP	42/SP25
SPV	42/SPV7
SC	96/SC9
SCV	96/SCV

Assortments

AS	5915VU/AS
E	5980ET/A
I	5980ID
MT	5902MT
U	5915VU/3
SBK	5940SBK
VG	5904VG/5T
VI	5902VI

Sockets

A	910A
B	910B
ES	920ES
FTX	910FTX

Most used symbols

	Example
PT	910PT
X	920A/C12X

Screwdrivers and bits

LP	920LP
PE	920PE
PH	920PH
PZ	1299PZ
RTX	1298RTX
SP	861SP
TRW	861TRW
TQS	861TQS
TX	920TX
XZN	920XZN

Miscellaneous

AS	42AS
BA	42BA
BM	1150BM
C	C25
HS	42HS
INOX	42 INOX
L	952L
MQ	1150MQ
MP	42MP
R	338R

The pictures are given by way of example.

Beta Utensili reserve the right to update and enhance their product range without notice.



Beta RECOMMENDS using the tools correctly and complying with personal protection standards.



PIN PUNCHES

Beta's striking tools have been designed to provide optimal performance and ensure the operator's safety.

A special type of steel, which contains chrome, molybdenum and vanadium (65CrMoV2-2) is used for production, resulting in remarkably hard and tough tools. The products are made – if so allowed by their geometry – with drawn bars; otherwise, they are hot-forged in a controlled atmosphere, to avoid slag formation.

- 1** The hexagon profiles prevent the tool from rolling on the supporting surface.
- 2** the pin punches are fitted with extremely long though perfectly straight shanks, to allow access to small spaces.
- 3** To make sure that the pin punches are correctly sized, every single piece is faced, so that a uniform cylindrical part and a perfectly flat end can be obtained, for increased efficacy.
- 4** All the faces are subjected to induction tempering, to prevent splintering; the deformation of the striking point is a natural consequence, so that the operator's safety can be ensured.



The centre and pin punches are sharpened after being chrome-plated, to provide improved engraving and cutting performance, and remove the galvanic deposit from the tips. Overdeposits need to be removed, to prevent "rounding" of the corners and brittleness as a result of the amount of hydrogen produced during electroplating. The worked areas are protected with a rust-proof layer.



30 drift punches



Ø mm	L mm	€	📦	📄
2	125	6,80	10	000300020
3	125	6,80	10	000300030
4	150	9,10	10	000300040
5	150	9,10	10	000300050
6	150	9,50	10	000300060

31 pin punches



Ø mm	L mm	L1 mm	€	📦	📄
2	110	22	6,80	10	000310002
3	128	35	7,05	10	000310003
4	146	45	8,65	10	000310004
5	164	55	9,10	10	000310005
6	182	65	11,40	5	000310006
8	200	80	12,10	5	000310008
10	220	95	15,20	5	000310010



31/B6N	62,50	1	000310024
2-3-4-5-6-8 mm			
2002/BV6	7,50	1	020020000
31/SP6	66,50	1	000310030
2-3-4-5-6-8 mm			
31/SPV	18,20	1	000310031

31BM pin punches with handles



Ø mm	L mm	L1 mm	€	📦	📄
2	168	42	14,00	2	000310402
3	180	52	14,40	2	000310403
4	191	62	15,60	2	000310404
5	200	72	16,50	2	000310405
6	221	82	18,90	2	000310406
8	235	94	20,00	2	000310408



31BM/D6	99,50	1	000310420
2-3-4-5-6-8 mm			

31L

pin punches, long series



∅ mm	L mm	L1 mm	€	5	10
4	175	80	10,30	5 000310104	
5	175	80	10,90	5 000310105	
6	175	80	13,00	5 000310106	

31SE

punches for spring pins



∅ mm	D mm	L mm	L1 mm	€	5	10
4	2,4	175	80	10,30	5 000310204	
5	3,0	175	80	10,90	5 000310205	
6	3,6	175	80	13,00	5 000310206	



31/B6N-LSE	76,00	1	000310324
31L: 4-5-6 mm			
31SE: 4-5-6 mm			
2002/BV6	7,50	1	020020000

32

centre punches



∅ mm	L mm	L1 mm	€	10	20
3	100	44	6,35	10 000320100	
4	125	52	7,80	10 000320125	
5	150	62	9,50	10 000320150	

32AU

automatic centre punches

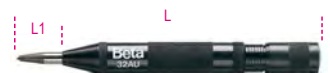

∅ mm	L mm	L1 mm	€	2	5
3	150	23	51,50	2 000320160	

32AUR

spare tip for automatic centre punch



∅ mm	€	5	10
3	9,30	5 000320170	

34

flat chisels



L mm	A mm	L1 mm	€	5	10
125	14,5	45	9,65	5 000340001	
150	17,0	58	12,70	5 000340002	
175	21,5	68	18,40	5 000340003	

35

flat chisels, ribbed type



L mm	A mm	€	5	10
100	14,5	11,30	5 000350001	
125	17,0	12,70	5 000350002	
150	20,5	15,70	5 000350003	
200	23,0	24,00	5 000350004	
250	28,5	34,50	2 000350005	
300	34,0	46,50	2 000350006	

35PM

flat chisels, ribbed type with hand guards



L mm	A mm	€	2	5	10
200	23,0	36,00	2 000350014		
250	28,5	46,50	2 000350015		
300	34,0	59,00	2 000350016		

35PMR

spare hand guards



L mm	€	1	5	10
200	11,90	1 000350024		
250	11,90	1 000350025		
300	12,50	1 000350026		

36

cape chisels



L mm	A mm	L1 mm	€	5	10
125	4	44	10,10	5 000360001	
150	6	53	11,90	5 000360002	

37

cape chisels, ribbed type



L mm	A mm	L1 mm	€	5	10
150	6	45	18,20	5 000370001	
200	8	55	26,00	3 000370002	

37PM

cape chisel, ribbed type with hand guard



L mm	A mm	€	2	5	10
200	8	38,50	2 000370012		

37PMR

spare hand guard



L mm	€	1	5	10
200	12,50	1 000370022		



38/B6N



38/SP6

38/B6N	63,00	1	000380016
30: 2-3 mm			
32: 4 mm			
34: 125-150 mm			
36: 150 mm			
2002/BV6	7,50	1	020020000
38/SP6	67,50	1	000380009
30: 2-3 mm			
32: 4 mm			
34: 125-150 mm			
36: 150 mm			
38/SPV	18,20	1	000380019

A NEW SHAPE

Our epoch-making wrench 42 has a new shape.

A stylish, slim shape enhanced by a slender profile, lighter to the touch. The strength, resilience and ergonomic design of the Beta wrench reach even higher values, to provide users with the best possible tool. The manufacturing process is carried out in our factories in Sovico and Sulmona, on the basis of state-of-the-art automation technology and the best trained workers.

RAPID

A 15 degree angle compared to the axis, to reduce the take-up angle

RESILIENT

Remarkable strength: in case of improper use, the wrench buckles, without breaking suddenly and dangerously

HOMOGENEOUS

Pressing is based on a round-section semi-finished product which results in homogeneously distributed fibres, thereby preventing dangerous internal stress formation

ACCESSIBLE

Reduced thickness for improved accessibility

PROTECTED

Nickel-chrome plating provides lasting resistance to external agents and meets the stringent requirements of adhesion tests under ISO 2819

OPTIMIZED

The wrench, which is longer than most competitors', allows high torques to be obtained through reduced effort



ERGONOMIC

The offset ring has a 15 degree angle to protect the hand. The shape is obtained from a die; it is not bent later

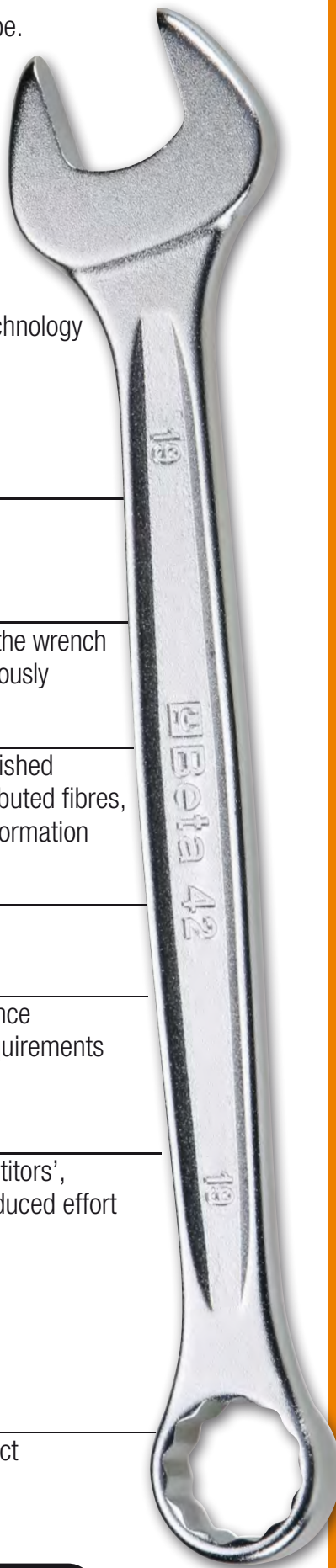

CAUTION!

The new shape of wrench 42 is perfectly compatible with all the containers and trays of our epoch-making wrench 42

42

combination wrenches

Torque values more than doubled compared to the requirements to be satisfied under ISO 1711



DIN 3113 UN-ISO 7738

mm	L mm	S1 mm	€	🔧	📦
5,5x5,5	95	3,4	7,35	5	000421005
6x6	95	3,4	7,45	5	000421006
7x7	105	3,6	7,50	5	000421007
8x8	116	3,9	7,65	5	000421008
9x9	127	4,2	8,15	5	000421009
10x10	137	4,5	8,35	5	000421010
11x11	148	4,8	8,95	5	000421011
12x12	158	5,1	9,15	5	000421012
13x13	169	5,6	9,20	5	000421013
14x14	180	5,7	10,50	5	000421014
15x15	190	6,0	11,50	5	000421015
16x16	201	6,3	11,90	5	000421016
17x17	212	6,8	12,60	5	000421017
18x18	222	7,0	13,30	5	000421018
19x19	233	7,5	13,70	5	000421019
20x20	243	7,7	15,40	3	000421020
21x21	254	7,9	16,60	3	000421021
22x22	264	8,3	17,10	3	000421022
23x23	275	8,5	18,50	3	000421023
24x24	285	8,7	19,40	3	000421024
25x25	296	8,7	20,70	2	000421025
26x26	307	8,9	22,20	2	000421026
27x27	317	9,1	24,10	2	000421027
28x28	328	9,3	25,00	2	000421028
29x29	338	9,5	27,00	2	000421029
30x30	349	9,7	28,00	2	000421030
32x32	370	10,1	31,00	2	000421032
34x34	391	10,5	59,00	1	000421034
35x35	412	10,7	64,00	1	000421035
36x36	412	10,7	66,50	1	000421036
38x38	433	11,3	73,50	1	000421038
41x41	465	12,0	81,50	1	000421041



	€	🔧	📦
42/B9N	95,50	1	000421074
6-7-8-10-11-13-14-17-19 mm			
2002/BV9	9,65	1	020020030



	€	🔧	📦
42/S14	155,00	1	000421067
6-7-8-10-11-12-13-14 -15-16-17-19-22-24 mm			
42/S17	189,00	1	000421065
6-7-8-9-10-11-12-13-14-15 16-17-18-19-20-21-22 mm			
42/S15	214,50	1	000421066
6-7-8-10-11-12-13-14 17-19-22-24-27-30-32 mm			
42/S17X	223,50	1	000421068
6-7-8-10-11-12-13-14 15-16-17-19-21-22- 24-27-30 mm			
42/S26	405,00	1	000421070
6-7-8-9-10-11-12-13-14 15-16-17-18-19-20-21 22-23-24-25-26-27-28 29-30-32 mm			

set of 9 combination wrenches with compact support

Torque values more than doubled compared to the requirements to be satisfied under ISO 1711



	€	🔧	📦
42/SC9I 8-10-11-12-13-14-15-17-19 mm	99,00	1	000421087
142/SCV9I	9,45	1	001420103
42/SC9E 8-10-11-12-13-16-17-18-19 mm	102,50	1	000421088
142/SCV9E	9,45	1	001420104



	€	🔧	📦
42/SP25 6-7-8-9-10-11-12-13-14 15-16-17-18-19-20-21 22-23-24-25-26-27-28 30-32 mm	426,00	1	000421085
42/SPV2	48,50	1	000420090



42/SP15

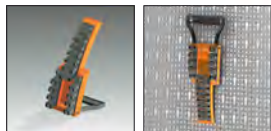

42/SPV...

	€	🔧	📦
42/SP15 6-7-8-9-10-11-12-13-14-15 16-17-19-22-24 mm	169,00	1	000421078
42/SPV7 42: 8-10-11-13-14-17-19 mm 55: 6x7-8x9-10x11-12x13 14x15-16x17-18x19 mm	6,70	1	000420097
42/SPV11 42MP: 8-9-10-11-12-13 14-15-16-17-19 mm	9,45	1	000420100
142-142SN: 8-9-10-11-12-13 14-15-16-17-19 mm			
42/SPV15 42: 6-7-8-9-10-11-12-13-14 15-16-17-19-22-24 mm	12,80	1	000420102

42AS

combination wrenches,
open and offset ring ends



🔧	L mm	€	🔧	📦
1/4x1/4	95	9,05	2	000420106
9/32x9/32	106	9,15	2	000420107
5/16x5/16	116	9,25	2	000420108
3/8x3/8	137	10,30	2	000420110
7/16x7/16	148	10,90	2	000420111
1/2x1/2	169	11,30	2	000420113
9/16x9/16	180	12,30	2	000420114
19/32x19/32	191	13,50	2	000420115
5/8x5/8	201	14,30	2	000420116
11/16x11/16	212	15,30	2	000420117
3/4x3/4	233	16,30	2	000420119
13/16x13/16	254	19,70	2	000420121
7/8x7/8	264	20,30	2	000420122
15/16x15/16	285	23,60	2	000420124
1x1	296	24,50	2	000420125
1.1/16x1.1/16	317	28,00	2	000420127
1.1/8x1.1/8	338	30,00	2	000420129
1.1/4x1.1/4	370	36,50	2	000420132
1.5/16x1.5/16	391	60,50	1	000420133
1.3/8x1.3/8	412	69,00	1	000420135
1.7/16x1.7/16	412	71,50	1	000420136
1.1/2x1.1/2	433	75,50	1	000420138



	€	🔧	📦
42AS/B9N 1/4-5/16-3/8-7/16-1/2	118,50	1	000420159
9/16-5/8-11/16-3/4			
2002/BV9	9,65	1	020020030



	€	🔧	📦
42AS/13 1/4-5/16-3/8-7/16-1/2-9/16-5/8 11/16-3/4-13/16-7/8-15/16-1	197,00	1	000420163
42AS/16 1/4-5/16-3/8-7/16-1/2-9/16-5/8 11/16-3/4-13/16-7/8-15/16-1- 1.1/16-1.1/8-1.1/4	292,00	1	000420166
42AS/17 1/4-9/32-5/16-3/8-7/16-1/2- 9/16-19/32-5/8-11/16-3/4- 13/16-7/8-15/16-1-1.1/16-1.1/8	278,00	1	000420168



42MP

combination wrenches, open and offset
ring ends, bright chrome-plated



DIN 3113 UNI-ISO 7738

🔧	L mm	€	🔧	📦
6x6	95	12,40	5	000420606
7x7	105	12,50	5	000420607
8x8	116	12,60	5	000420608
9x9	127	12,70	5	000420609
10x10	137	12,80	5	000420610
11x11	148	13,00	5	000420611
12x12	158	13,10	5	000420612
13x13	169	13,30	5	000420613
14x14	180	14,40	5	000420614
15x15	190	15,50	5	000420615
16x16	201	16,50	5	000420616
17x17	212	17,10	5	000420617
18x18	222	18,40	5	000420618
19x19	233	18,90	5	000420619
20x20	243	21,70	3	000420620
21x21	254	22,80	3	000420621
22x22	264	23,40	3	000420622
24x24	285	27,00	3	000420624
27x27	317	32,00	3	000420627
30x30	349	39,50	3	000420630
32x32	370	41,50	3	000420632



	€	🔧	📦
42MP/B9N 6-7-8-10-11-13-14-17-19 mm	136,50	1	000420661
2002/BV9	9,65	1	020020030



	€	🔧	📦
42MP/S17 6-7-8-9-10-11-12-13-14-15 16-17-18-19-20-21-22 mm	271,00	1	000420652
42MP/S21 6-7-8-9-10-11-12-13-14 15-16-17-18-19-20-21-22 24-27-30-32 mm	411,00	1	000420653

42LMP

combination wrenches, open and offset ring ends, long series, bright chrome-plated



mm	L mm	€		
8x8	148	11,90	2	000420508
9x9	167	12,20	2	000420509
10x10	172	12,70	2	000420510
11x11	186	13,30	2	000420511
12x12	197	13,60	2	000420512
13x13	207	13,80	2	000420513
14x14	223	14,80	2	000420514
15x15	233	16,20	2	000420515
16x16	243	17,40	2	000420516
17x17	261	18,50	2	000420517
18x18	270	20,20	2	000420518
19x19	280	20,70	2	000420519
21x21	301	23,90	2	000420521
22x22	318	24,60	2	000420522
24x24	338	28,50	2	000420524
27x27	376	33,00	2	000420527
30x30	409	42,00	2	000420530
32x32	435	45,50	2	000420532



42LMP/S14 234,00 1 000420551

8-9-10-11-12-13-14
15-16-17-18-19-21-22 mm

42LMP/S18 383,00 1 000420552

8-9-10-11-12-13-14
15-16-17-18-19-21-22
24-27-30-32 mm

42SLIM

combination wrenches with thin open ends



DIN 3113 UNI-ISO 7738

mm	L mm	S1 mm	€		
8x8	116	3,4	8,20	5	000420408
10x10	137	3,8	8,90	5	000420410
11x11	148	3,8	9,45	5	000420411
12x12	158	4,2	9,60	5	000420412
13x13	169	4,4	9,75	5	000420413
14x14	180	4,6	11,10	5	000420414
15x15	190	4,7	12,10	5	000420415
16x16	201	4,7	12,50	5	000420416
17x17	212	5,1	12,90	5	000420417
18x18	222	5,1	13,90	5	000420418
19x19	233	5,6	14,20	5	000420419



42SLIM/B8NI 97,50 1 000420478

10-11-12-13-14-15-17-19 mm

42SLIM/B8NE 101,00 1 000420479

10-11-12-13-16-17-18-19 mm

2002/BV8 9,65 1 020020020



42SLIM/S11 122,50 1 000420471

8-10-11-12-13-14-15-
16-17-18-19 mm

45

combination wrenches,
open and offset ring ends, heavy series



DIN 3113 UNI-ISO 7738

mm	L mm	€		
46x46	500	173,00	1	000450046
50x50	540	194,50	1	000450050
55x55	560	278,00	1	000450055
60x60	600	356,00	1	000450060
65x65	675	428,00	1	000450065
70x70	675	468,00	1	000450070
75x75	720	545,00	1	000450075
80x80	720	629,00	1	000450080

52

single open end wrenches



UNI 6733 DIN 3114

mm	L mm	€		
10	119	9,05	5	000520010
11	119	9,25	5	000520011
12	119	9,55	5	000520012
13	145	10,80	5	000520013
14	145	11,00	5	000520014
15	145	11,30	5	000520015
16	159	12,20	5	000520016
17	159	12,30	5	000520017
18	159	13,10	5	000520018
19	175	14,30	5	000520019
20	175	15,30	5	000520020
21	175	15,70	5	000520021
22	196	17,70	2	000520022
23	196	18,30	2	000520023
24	196	18,60	2	000520024
25	215	20,90	2	000520025
26	215	21,30	2	000520026
27	215	21,40	2	000520027
28	240	25,00	2	000520028
30	240	25,50	2	000520030
32	270	30,00	2	000520032
34	270	33,00	1	000520034
35	295	37,50	1	000520035
36	295	37,50	1	000520036
38	295	42,50	1	000520038
40	335	52,00	1	000520040
41	335	52,00	1	000520041
42	335	57,50	1	000520042
45	370	66,00	1	000520045
46	370	66,00	1	000520046
48	370	76,50	1	000520048
50	415	89,00	1	000520050
52	415	100,00	1	000520052
55	415	103,50	1	000520055
60	490	131,50	1	000520060
65	490	133,50	1	000520065
70	490	151,00	1	000520070

53

single open end wrenches DIN 894



mm	L mm	€		
36	317	28,00	1	000530036
38	320	30,50	1	000530038
41	342	36,00	1	000530041
46	396	44,00	1	000530046
50	412	68,50	1	000530050
55	457	78,00	1	000530055
60	492	96,50	1	000530060
65	528	115,00	1	000530065
70	572	133,00	1	000530070
75	608	166,00	1	000530075
80	645	204,00	1	000530080
85	690	248,00	1	000530085
90	690	293,00	1	000530090
95	847	410,00	1	000530095
100	847	432,00	1	000530100
105	1000	540,00	1	000530105
110	1000	584,00	1	000530110
115	1000	651,00	1	000530115
120	1000	738,00	1	000530120
125	1000	852,00	1	000530125
130	1000	913,00	1	000530130
135	1000	980,00	1	000530135

55

double open end wrenches



UNI-ISO 10102 DIN 3110

mm	L mm	€		
4x5	101	5,30	5	000550003
5x5,5	101	6,00	5	000550006
5,5x7	120	6,00	5	000550009
6x7	120	4,70	5	000550012
7x8	140	6,00	5	000550018
8x9	140	4,80	5	000550021
8x10	140	6,00	5	000550024
10x11	155	5,10	5	000550030
10x12	155	6,90	5	000550033
10x13	170	7,55	5	000550035
12x13	170	5,75	5	000550042
12x14	170	7,75	5	000550045
13x14	185	8,65	5	000550047
13x17	189	9,25	5	000550051
14x15	185	7,20	5	000550054
14x17	189	10,00	5	000550057
16x17	202	8,25	5	000550060
17x19	220	11,10	2	000550063
18x19	220	9,85	2	000550066
19x22	236	12,70	2	000550069
20x22	236	11,10	2	000550075
21x23	245	11,80	2	000550078
22x24	245	13,70	2	000550081
24x26	262	14,10	2	000550087
24x27	262	15,30	2	000550090
25x28	272	16,00	2	000550096
27x29	284	18,20	2	000550099
27x30	284	20,90	2	000550102
27x32	297	22,70	2	000550105
30x32	297	20,10	2	000550108
32x36	325	62,00	1	000550114
34x36	325	62,00	1	000550117
35x38	375	68,50	1	000550120
36x41	375	71,50	1	000550123
41x46	425	82,00	1	000550129
46x50	475	101,50	1	000550132
50x55	500	118,00	1	000550135
55x60	500	125,00	1	000550138



55/B8N	€ 66,50	1	000550160
6x7-8x9-10x11-12x13 14x15-16x17-18x19 20x22 mm			
2002/BV8	9,65	1	020020020
55/B12N	134,50	1	000550164
6x7-8x9-10x11-12x13 14x15-16x17-18x19 20x22-21x23-24x26 25x28-30x32 mm			
2002/BV12	16,00	1	020020040



55/S8	€ 56,50	1	000550174
6x7-8x9-10x11-12x13 14x15-16x17-18x19 20x22 mm			
55/S12	118,50	1	000550178
6x7-8x9-10x11-12x13 14x15-16x17-18x19 20x22-21x23-24x26 25x28-30x32 mm			
55/S12X	120,00	1	000550179
6x7-8x9-10x11-12x13 14x15-16x17-18x19 20x22-21x23-24x27 25x28-30x32 mm			
55/S13	137,00	1	000550182
6x7-8x9-10x11-12x13 14x15-16x17-18x19 20x22-21x23-24x26 25x28-27x29-30x32 mm			



55/SP7	€ 48,50	1	000550167
6x7-8x9-10x11-12x13 14x15-16x17-18x19 mm			
42/SPV7	6,70	1	000420097
42: 8-10-11-13-14-17-19 mm 55: 6x7-8x9-10x11-12x13 14x15-16x17-18x19 mm			
55/SP13	170,00	1	000550186
6x7-8x9-10x11-12x13 14x15-16x17-18x19 20x22-21x23-24x26 25x28-27x29-30x32 mm			
55/SPV	33,00	1	000550190

55AS double open end wrenches



⊗	L mm	€	⊗	⊗
1/4x9/32	120	6,35	2	000550203
1/4x5/16	120	6,35	2	000550206
5/16x11/32	140	6,80	2	000550209
5/16x3/8	140	6,80	2	000550212
3/8x7/16	155	7,35	2	000550215
7/16x1/2	170	8,10	2	000550218
1/2x9/16	170	8,65	2	000550221
9/16x5/8	185	9,55	2	000550224
19/32x11/16	189	11,60	2	000550227
5/8x11/16	202	11,60	2	000550230
5/8x3/4	202	13,00	2	000550233
11/16x13/16	220	13,60	2	000550242
3/4x7/8	236	14,70	2	000550245
25/32x13/16	236	14,70	2	000550244
7/8x15/16	245	15,80	2	000550251
15/16x1	262	20,10	1	000550257
1x1.1/8	272	21,10	1	000550259
1.1/16x1.1/4	284	27,50	1	000550267
1.1/8x1.5/16	297	27,50	1	000550266
1.5/16x1.1/2	325	73,00	1	000550269
1.3/8x1.1/2	375	80,50	1	000550272
1.7/16x1.5/8	375	80,50	1	000550275



55AS/5	€ 49,00	1	000550290
5/16x11/32-3/8x7/16 1/2x9/16-5/8x11/16 3/4x7/8			
55AS/8	78,50	1	000550296
1/4x9/32-5/16x11/32-3/8x7/16- 1/2x9/16-9/16x5/8-5/8x11/16- 11/16x13/16-3/4x7/8			
55AS/12	162,00	1	000550298
1/4x9/32-5/16x11/32-3/8x7/16-1 1/2x9/16-9/16x5/8-5/8x11/16- 11/16x13/16-25/32x13/16-3/4x7/8- 15/16x1-1x1.1/8-1.1/16x1.1/4			

55MP double open end wrenches, bright chrome-plated



UNI-ISO 10102 DIN 3110

⊗	L mm	€	⊗	⊗
6x7	120	6,35	2	000550603
8x9	140	6,80	2	000550606
10x11	155	7,55	2	000550609
12x13	170	8,25	2	000550612
14x15	185	9,85	2	000550615
16x17	202	11,50	2	000550618
18x19	220	13,30	2	000550621
20x22	236	15,30	2	000550624
21x23	245	16,70	2	000550627
24x26	262	19,90	1	000550630
25x28	272	20,90	1	000550633
27x29	284	24,50	1	000550636
30x32	297	27,50	1	000550639

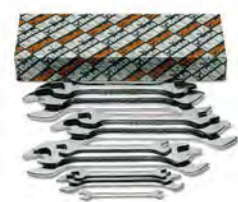

55MP/S8	€ 79,00	1	000550650
6x7-8x9-10x11-12x13 14x15-16x17-18x19 20x22 mm			
55MP/S13	188,50	1	000550651
6x7-8x9-10x11-12x13 14x15-16x17-18x19 20x22-21x23-24x26 25x28-27x29-30x32 mm			
55MP/S12	164,00	1	000550653
6x7-8x9-10x11-12x13-14x15- 16x17-18x19-20x22-21x23-24x26- 25x28-30x32 mm			

58 open end slogging wrenches



DIN 133

⊗	L mm	€	⊗	⊗
24	177	28,50	1	000580024
27	180	30,00	1	000580027
30	190	33,50	1	000580030
32	190	35,00	1	000580032
34	200	44,00	1	000580034
36	215	45,00	1	000580036
41	235	53,50	1	000580041
46	255	71,50	1	000580046
50	275	80,00	1	000580050
55	300	96,00	1	000580055
60	320	105,50	1	000580060
65	342	138,00	1	000580065
70	375	178,00	1	000580070
75	375	194,50	1	000580075
80	408	284,00	1	000580080
85	408	318,00	1	000580085
90	445	367,00	1	000580090
95	445	378,00	1	000580095
100	485	523,00	1	000580100
105	485	590,00	1	000580105
110	510	646,00	1	000580110
115	510	735,00	1	000580115
120	545	758,00	1	000580120
125	545	868,00	1	000580125
130	575	1.170,00	1	000580130
135	575	1.235,00	1	000580135
*140	575	1.335,00	1	000580140
*145	640	1.830,00	1	000580145
*150	640	1.900,00	1	000580150
*155	640	2.080,00	1	000580155
*160	640	2.280,00	1	000580160
*165	715	2.445,00	1	000580165
*170	715	3.330,00	1	000580170
*175	715	3.520,00	1	000580175
*180	715	3.820,00	1	000580180
*185	715	3.930,00	1	000580185
*190	800	4.310,00	1	000580190
*195	800	4.530,00	1	000580195
*200	800	4.750,00	1	000580200
*210	800	5.920,00	1	000580210
*220	800	7.650,00	1	000580220
*230	800	9.330,00	1	000580230



73

small double open end wrenches



UNI 6737

mm	L mm	€	Hand	Code
4x4	78	8,00	5	000730040
4,5x4,5	78	8,00	5	000730045
5x5	78	8,00	5	000730050
5,5x5,5	86	8,65	5	000730055
6x6	86	8,65	5	000730060
7x7	86	8,65	5	000730070
8x8	97	9,05	5	000730080
9x9	97	9,05	5	000730090
10x10	108	9,85	5	000730100
11x11	108	9,85	5	000730110
12x12	124	11,30	5	000730120
13x13	124	11,30	5	000730130
14x14	124	11,30	5	000730140



73/B13N	131,50	1	000730202
4-4,5-5-5,5-6-7-8-9			
10-11-12-13-14 mm			
2002 BV13	9,65	1	020020050



73/S13	121,50	1	000730210
4-4,5-5-5,5-6-7-8-9			
10-11-12-13-14 mm			

78

ring slogging wrenches



DIN 7444

mm	L mm	€	Hand	Code
24	162	29,00	1	000780024
27	180	34,50	1	000780027
30	190	40,50	1	000780030
32	190	43,50	1	000780032
34	200	49,50	1	000780034
36	205	53,50	1	000780036
41	225	69,00	1	000780041
46	235	77,00	1	000780046
50	250	92,00	1	000780050
55	265	105,00	1	000780055
60	275	127,50	1	000780060
65	295	161,50	1	000780065
70	325	162,50	1	000780070
75	325	192,50	1	000780075
80	350	295,00	1	000780080
85	350	323,00	1	000780085
90	390	395,00	1	000780090
95	390	457,00	1	000780095
100	420	506,00	1	000780100
105	420	596,00	1	000780105
110	450	651,00	1	000780110
115	450	741,00	1	000780115
120	490	1.019,00	1	000780120
125	480	1.375,00	1	000780125
130	520	1.585,00	1	000780130
135	520	1.700,00	1	000780135
*140	520	1.935,00	1	000780140
*145	580	2.435,00	1	000780145
*150	580	2.550,00	1	000780150
*155	580	2.940,00	1	000780155
*160	650	3.010,00	1	000780160
*165	650	3.200,00	1	000780165
*170	650	3.840,00	1	000780170
*175	650	4.150,00	1	000780175
*180	650	4.560,00	1	000780180
*185	695	4.700,00	1	000780185
*190	695	5.140,00	1	000780190
*195	695	5.150,00	1	000780195
*200	695	5.230,00	1	000780200
*210	740	5.570,00	1	000780210
*215	740	6.240,00	1	000780215
*220	740	6.880,00	1	000780220
*230	740	8.520,00	1	000780230

78AS

ring slogging wrenches



mm	L mm	€	Hand	Code
*1.1/16	180	41,50	1	000780327
*1.1/8	190	41,50	1	000780329
*1.3/16	190	41,50	1	000780330
*1.1/4	197	45,00	1	000780332
*1.5/16	197	46,00	1	000780333
*1.3/8	223	49,50	1	000780335
*1.7/16	223	60,00	1	000780336
*1.1/2	223	61,50	1	000780338
*1.5/8	223	70,00	1	000780341
*1.11/16	225	73,50	1	000780343
*1.13/16	240	81,00	1	000780346
*1.7/8	250	82,00	1	000780348
*2	250	93,50	1	000780350
*2.1/16	250	96,50	1	000780352
*2.3/16	275	102,00	1	000780355
*2.3/8	270	138,00	1	000780360
*2.9/16	302	153,00	1	000780365
*2.3/4	350	166,00	1	000780370
*2.15/16	350	192,00	1	000780375
*3.1/8	354	317,00	1	000780380

80

double swivel end socket wrenches



mm	L mm	€	Hand	Code
6x7	170	32,50	3	000800006
8x9	176	33,50	3	000800008
8x10	179	33,50	3	000800009
10x11	182	35,50	3	000800010
12x13	228	40,00	3	000800012
14x15	232	40,50	3	000800014
13x17	231	43,50	3	000800015
16x17	234	43,50	2	000800016
18x19	285	53,50	2	000800018
19x22	287	56,00	2	000800019
20x22	289	56,00	2	000800020
21x23	289	57,00	2	000800021
24x27	405	93,50	2	000800024
30x32	413	99,50	2	000800030

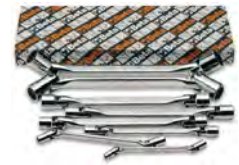

80/S8	335,00	1	000800051
6x7-8x9-10x11-12x13-14x15			
16x17-18x19-20x22 mm			
80/S11	585,00	1	000800056
6x7-8x9-10x11-12x13			
14x15-16x17-18x19-20x22			
21x23-24x27-30x32 mm			

83

half-moon ring wrenches



ISO 3318

mm	L mm	€	Hand	Code
8x10	126	16,20	3	000830008
10x12	137	16,90	3	000830010
11x13	138	17,40	3	000830011
14x17	183	21,90	3	000830014
15x17	184	24,90	2	000830015
16x18	196	27,00	2	000830016
19x22	231	35,00	2	000830019



83/S3	74,50	1	000830081
11x13-14x17-19x22 mm			
83/S5	121,00	1	000830085
10x12-11x13-15x17			
16x18-19x22 mm			

Beta

83AS

half-moon ring wrenches



mm	L mm	€	U	PC
7/16x1/2	138	20,80	2	000830111
9/16x5/8	183	24,60	2	000830114
3/4x7/8	230	39,00	2	000830119



83AS/3	€ 84,50	1	000830181
7/16x1/2-9/16x5/8 3/4x7/8			

88

double ended flat ring wrenches, extra-long series



mm	L mm	€	U	PC
8x10	235	18,40	2	000880008
12x14	330	21,70	2	000880012
13x15	330	21,70	2	000880013
16x18	405	30,00	2	000880016
17x19	405	30,00	2	000880017
21x23	435	35,00	2	000880021
22x24	435	35,00	2	000880022



88/S7	€ 192,00	1	000880107
8x10-12x14-13x15-16x18- 17x19-21x23-22x24 mm			

90

double ended deep offset ring wrenches



DIN 838 ISO 10104

mm	L mm	€	U	PC
6x7	165	9,05	5	000900006
8x9	180	9,70	5	000900012
8x10	180	11,40	5	000900015
10x11	195	10,70	5	000900018
10x12	195	11,60	5	000900021
11x13	215	12,80	5	000900024
12x13	215	11,70	5	000900027
12x14	215	13,40	5	000900030
14x15	230	12,80	5	000900033
14x17	250	15,80	5	000900036
16x17	250	14,60	5	000900039
17x19	265	18,80	5	000900042
18x19	265	16,90	5	000900045
19x22	285	21,10	3	000900048
20x22	285	19,60	3	000900051
21x23	305	22,10	2	000900057
22x24	305	23,90	2	000900060
24x26	325	24,80	2	000900063
24x27	325	27,50	2	000900067
25x28	340	29,50	2	000900070
27x29	355	32,00	2	000900073
27x30	355	35,00	2	000900076
27x32	375	38,50	2	000900078
30x32	375	36,00	2	000900080
32x36	395	53,50	1	000900088
34x36	415	63,50	1	000900089
35x38	415	64,50	1	000900091
36x41	435	73,50	1	000900094
41x46	460	105,50	1	000900097
46x50	500	139,00	1	000900100



90/B8N	€ 114,50	1	000900156
6x7-8x9-10x11-12x13 14x15-16x17-18x19 20x22 mm			
2002/BV8	€ 9,65	1	020020020



90/S8	€ 105,00	1	000900162
6x7-8x9-10x11-12x13 14x15-16x17-18x19 20x22 mm			
90/S12	€ 217,50	1	000900166
6x7-8x9-10x11-12x13 14x15-16x17-18x19 20x22-21x23-24x26 25x28-30x32 mm			
90/S12X	€ 220,00	1	000900167
6x7-8x9-10x11-12x13 14x15-16x17-18x19 20x22-21x23-24x27 25x28-30x32 mm			
90/S13	€ 249,50	1	000900170
6x7-8x9-10x11-12x13 14x15-16x17-18x19 20x22-21x23-24x26 25x28-27x29-30x32 mm			



90/SP13	€ 282,00	1	000900174
6x7-8x9-10x11-12x13 14x15-16x17-18x19 20x22-21x23-24x26 25x28-27x29-30x32 mm			
55/SPV	€ 33,00	1	000550190

90AS

double ended deep offset ring wrenches



mm	L mm	€	U	PC
1/4x5/16	165	10,50	2	000900203
5/16x11/32	180	11,20	2	000900206
5/16x3/8	180	11,50	2	000900209
3/8x7/16	195	11,70	2	000900212
7/16x1/2	215	13,10	2	000900215
1/2x9/16	230	15,00	2	000900218
9/16x5/8	230	15,00	2	000900221
19/32x11/16	250	16,40	2	000900222
5/8x11/16	250	16,90	2	000900224
5/8x3/4	265	20,10	2	000900227
11/16x3/4	265	20,10	1	000900230
11/16x13/16	265	20,10	1	000900233
3/4x25/32	265	23,20	1	000900235
3/4x7/8	285	23,20	1	000900237
13/16x7/8	285	23,60	1	000900240
7/8x15/16	305	23,60	1	000900243
15/16x1	325	28,50	1	000900252
1.1/16x1.1/4	375	41,50	1	000900258
1.1/8x1.5/16	375	42,00	1	000900261



90AS/8	€ 137,50	1	000900298
1/4x5/16-5/16x11/32 3/8x7/16-1/2x9/16 5/8x11/16-11/16x3/4 13/16x7/8-15/16x1			
90AS/10	€ 221,00	1	000900300

1/4x5/16-5/16x11/32 3/8x7/16-1/2x9/16 5/8x11/16-11/16x3/4 13/16x7/8-15/16x1 1.1/16x1.1/4-1.1/8x1.5/16			
---	--	--	--

Beta

Beta

91 heavy duty offset ring wrenches



mm	Ø mm	€		
24	38	52,50	1	000910024
27	41	54,00	1	000910027
30	48	58,00	1	000910030
32	49	62,50	1	000910032
36	54	71,50	1	000910036
41	62	85,00	1	000910041
46	69	99,50	1	000910046
50	76	113,50	1	000910050
55	81	126,50	1	000910055
60	90	158,00	1	000910060
65	98	177,00	1	000910065
70	105	199,00	1	000910070
75	110	228,00	1	000910075
80	125	262,00	1	000910080
85	125	273,00	1	000910085
90	140	490,00	1	000910090
95	140	535,00	1	000910095
100	143	568,00	1	000910100
105	146	634,00	1	000910105

92 tubes for item 91



92/	L mm	91 mm	Ø mm	€		
92/1	460	24÷30	19	31,50	1	000920010
92/2	610	32÷41	22	48,00	1	000920020
92/3	760	46÷55	25	68,50	1	000920030
92/4	860	60÷105	30	91,00	1	000920040

93 double-ended offset ring wrench for scaffolding bolts



mm	L mm	€		
21x22	310	37,00	3	000930021

93C ratcheting double-ended offset ring wrenches for scaffolding bolts



mm	L mm	€		
17x19	310	43,50	1	000930117
19x22	310	46,50	1	000930119
19x24	310	57,00	1	000930120
21x22	365	52,50	1	000930121
36x38	445	87,50	1	000930136

94 flare nut open ring wrenches



DIN 3118

mm	L mm	€		
8x10	140	15,80	2	000940008
9x11	153	16,50	2	000940009
10x11	153	17,30	2	000940010
11x13	175	17,90	2	000940011
12x14	175	18,90	2	000940012
13x15	175	18,90	2	000940013
14x15	175	22,30	2	000940014
14x17	195	22,80	2	000940015
17x19	212	23,40	2	000940017
19x22	228	25,00	2	000940019
22x24	242	30,50	2	000940022
24x27	260	33,50	2	000940024
30x32	300	43,50	2	000940030
36x41	320	74,00	1	000940036



94/S6	€		
8x10-10x11-11x13-12x14 17x19-19x22 mm	118,50	1	000940050
94/S10	242,50	1	000940052
8x10-9x11-10x11-11x13 12x14-17x19-19x22 22x24-24x27-30x32 mm			

95 double ended flat ring wrenches



DIN 837 ISO 10103

mm	L mm	€		
6x7	120	10,40	3	000950161
8x9	135	11,10	3	000950162
10x11	150	12,60	3	000950163
12x13	165	13,70	3	000950164
14x15	185	14,40	3	000950165
16x17	210	15,30	3	000950166
17x19	225	17,70	3	000950167
18x19	225	17,70	2	000950168
20x22	240	20,10	2	000950169
21x23	255	21,10	2	000950170
24x26	270	22,30	2	000950171
25x28	285	27,00	2	000950172
27x29	315	27,50	2	000950173
30x32	335	31,00	2	000950174



95/S8	€		
6x7-8x9-10x11-12x13 14x15-16x17-18x19 20x22 mm	115,50	1	000950177
95/S13	244,00	1	000950179
6x7-8x9-10x11-12x13 14x15-16x17-18x19 20x22-21x23-24x26 25x28-27x29-30x32 mm			

95FTX double-ended straight wrenches, for Torx® head screws



E6xE8	L mm	€		
E6xE8	115	10,70	2	000950306
E10xE12	143	11,20	2	000950310
E14xE18	177	12,80	2	000950314
E20xE24	224	17,30	2	000950320



95FTX/S4	€		
E6xE8-E10xE12 E14xE18-E20xE24	52,00	1	000950325



Beta

OFFSET HEXAGON KEY WRENCHES

Beta's hexagon key wrenches have been designed for long, accurate operation. The wide range covers all use requirements: the extra-short, short, long, extra-long, ball head and T-wrenches as well as the wrenches with high torque handles are among Beta's flagship products and are unrivalled in the market.

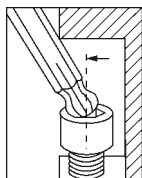

The ball head offset hexagon key wrenches allow operation at an angle of up to 30° to the screw axis.

The keys are packaged in a wallet for quick identification of the required size. When closed, it prevents the wrenches, including the smaller ones, from accidentally coming out.



The Color version combines the outstanding features of the standard wrenches with immediate identification of the required size to speed up daily work.



96/B8 2-2,5-3-4-5-6-8-10 mm	€ 16,40	5	000960386
96/B10 1,5-2-2,5-3-4-5-6-8-10-12 mm	€ 23,20	5	000960380
96N/BV	€ 1,79	1	000960651



96/SC9 1,5-2-2,5-3-4-5-6-8-10 mm	€ 19,50	1	000960374
96/SCV	€ 4,00	1	000960985



96/SC12 2-2,5-3-3,5-4-4,5-5-6-7-8-9-10 mm	€ 28,00	1	000960395
96/SCV12	€ 4,75	1	000960975

96

offset hexagon key wrenches
chrome-plated



ISO 2936

mm	L mm	L1 mm	€	QTY	Code
0,9	35	8	0,91	20	000960013
1,3	39	10	0,91	20	000960014
1,5	45	15	0,91	20	000960015
2	50	17	0,97	20	000960020
2,5	57	20	0,97	20	000960025
3	64	22	1,14	20	000960030
3,5	68	25	1,36	20	000960035
4	72	28	1,42	20	000960040
4,5	78	30	1,47	20	000960045
5	83	32	1,52	20	000960050
5,5	88	35	1,91	20	000960055
6	94	37	1,91	20	000960060
7	99	40	2,37	10	000960070
8	105	43	2,78	10	000960080
9	111	46	3,30	10	000960090
10	119	49	3,90	10	000960100
11	126	52	4,90	10	000960110
12	134	56	5,90	10	000960120
13	142	62	7,50	10	000960130
14	151	69	8,80	10	000960140
16	165	75	12,90	5	000960160
17	174	79	13,60	5	000960170
19	196	88	18,90	5	000960190
22	216	100	29,50	3	000960220
24	242	112	39,00	1	000960240
27	271	125	52,00	1	000960270
30	309	140	69,50	1	000960300
32	341	155	92,00	1	000960312
36	385	174	132,50	1	000960316



96/ST6 2,5-3-4-5-6-8 mm	€ 13,40	3	000960370
-----------------------------------	---------	---	-----------



96/BGS7 1,5-2-2,5-3-4-5-6 mm	€ 29,00	1	000960367
--	---------	---	-----------



96/BG7 2,5-3-4-5-6-8-10 mm	€ 31,00	1	000960368
--------------------------------------	---------	---	-----------

96N

offset hexagon key wrenches,
burnished



ISO 2936

mm	L mm	L1 mm	€	QTY	Code
0,9	32	10	0,46	20	000960409
1,3	44	12	0,46	20	000960413
1,5	46	15	0,49	20	000960415
2	51	17	0,51	20	000960420
2,5	57	20	0,53	20	000960425
3	64	22	0,59	20	000960430
3,5	68	25	0,71	20	000960435
4	72	28	0,81	20	000960440
4,5	78	30	0,89	20	000960445
5	83	32	0,92	20	000960450
6	94	37	1,16	20	000960460
7	99	40	1,54	10	000960470
8	105	43	1,84	10	000960480
9	111	46	2,39	10	000960490
10	119	49	2,84	10	000960500
11	126	52	3,50	10	000960510
12	134	56	4,30	10	000960520
13	142	62	5,70	10	000960530
14	151	69	6,45	10	000960540
16	165	72	9,70	5	000960560
17	174	79	10,50	5	000960570
19	194	88	14,10	5	000960590
22	216	99	26,00	1	000960592
24	242	111	34,50	1	000960594



96N/ST6
2,5-3-4-5-6-8 mm

€ 9,45 3 000960640



96N/G7
2,5-3-4-5-6-8-10 mm

€ 24,30 3 000960645

96N/G7A
1,5-2-2,5-3-4-5-6 mm

€ 16,90 3 000960643



96N/B10
1,5-2-2,5-3-4-5-6
8-10-12 mm

€ 15,80 5 000960650

96N/BV
1,79 1 000960651



96N/SC9
1,5-2-2,5-3-4-5-6-8-10 mm

€ 13,70 1 000960644

96N/SCV
4,00 1 000960986



96N/SC12
2-2,5-3-3,5-4-4,5-5
6-7-8-9-10 mm

€ 19,50 1 000960661

96N/SCV12
4,75 1 000960976

96C/AS

offset hexagon key wrenches,
chrome-plated



"	L mm	L1 mm	g	€	🔧	📦
1/16	46	16	1,01	1,61	20	000961702
3/32	53	19	2,70	2,23	20	000961706
1/8	60	22	5,33	2,34	20	000961710
5/32	67	25	9,33	2,73	20	000961714
3/16	74	28	14,87	3,10	20	000961716
7/32	81	32	22,00	3,50	20	000961718
1/4	89	35	31,40	3,90	20	000961720
5/16	103	40	56,16	4,40	10	000961724
3/8	117	45	91,31	5,40	10	000961728



96C-AS/SC9
1/16-3/32-1/8-5/32-3/16-
7/32-1/4-5/16-3/8

€ 33,00 1 000961753

96AS

offset hexagon key wrenches,
burnished



"	L mm	L1 mm	€	🔧	📦
1/30 (0,035")	44	14	0,82	20	000960698
1/20 (0,050")	44	15	0,82	20	000960701
1/16	46	16	0,89	20	000960702
5/64	50	18	1,09	20	000960704
3/32	53	19	1,25	20	000960706
7/64	57	21	1,29	20	000960708
1/8	60	22	1,30	20	000960710
9/64	64	24	1,55	20	000960712
5/32	68	25	1,61	20	000960714
3/16	75	29	1,79	20	000960716
7/32	82	32	2,01	20	000960718
1/4	89	35	2,34	20	000960720
5/16	103	40	2,92	10	000960724
3/8	117	44	3,55	10	000960728
7/16	132	49	5,20	10	000960730
1/2	149	54	6,50	10	000960732
9/16	151	69	10,70	2	000960734
5/8	165	72	12,90	1	000960736
3/4	194	88	21,40	1	000960738



96AS/SC9
1/16-3/32-1/8-5/32-3/16
7/32-1/4-5/16-3/8

€ 21,70 1 000960743

96AS/SCV
4,00 1 000960744



96AS/T7
3/32-1/8-5/32
3/16-7/32-1/4-5/16

€ 17,80 3 000960740



96AS/G7
3/32-1/8-5/32
3/16-1/4-5/16-3/8

€ 25,00 3 000960745



96AS/BG7
3/32-1/8-5/32-3/16
1/4-5/16-3/8

€ 31,00 1 000960747



96AS/B11
1/20-1/16-5/64-3/32
1/8-5/32-3/16-7/32
1/4-5/16-3/8

€ 21,40 1 000960749

96N/BV
1,79 1 000960651

96LC

offset hexagon key wrenches,
long series, chrome-plated



ISO 2936

mm	L mm	L1 mm	€	🔧	📦
2	101	17	1,74	20	000960320
2,5	113	20	1,86	20	000960321
3	127	22	2,03	20	000960322
3,5	138	25	2,08	20	000960323
4	142	28	2,26	20	000960324
4,5	154	28	2,65	20	000960325
5	163	32	2,87	20	000960326
6	184	37	3,10	20	000960327
7	194	40	3,55	10	000960328
8	205	43	4,40	10	000960329
9	216	46	4,80	10	000960330
10	231	49	6,25	10	000960331
12	259	56	7,70	10	000960332

Beta



96LC/SC8	€ 28,50	1	000960334
2-2,5-3-4-5-6-8-10 mm			
96LC/SCV	€ 4,00	1	000960983



96LC/SC12	€ 42,50	1	000960337
2-2,5-3-3,5-4-4,5-5-6-7-8-9-10 mm			
96LC/SCV12	€ 4,75	1	000960977

96L

offset hexagon key wrenches, long series, burnished



ISO 2936

mm	L mm	L1 mm	€	1	000960820
2	99	15	1,23	20	000960820
2,5	110	17	1,28	20	000960825
3	124	19	1,45	20	000960830
3,5	135	21	1,55	20	000960835
4	138	24	1,72	20	000960840
4,5	150	25	2,01	20	000960845
5	158	27	2,11	20	000960850
6	178	31	2,39	20	000960860
7	187	33	3,05	10	000960870
8	197	35	3,85	10	000960880
9	207	37	4,35	10	000960890
10	221	39	5,75	10	000960900
12	247	44	7,45	10	000960920



96L/SC8	€ 23,80	1	000960924
2-2,5-3-4-5-6-8-10 mm			
96L/SCV	€ 4,00	1	000960987



96L/SC12	€ 35,50	1	000960929
2-2,5-3-3,5-4-4,5-5-6-7-8-9-10 mm			
96L/SCV12	€ 4,75	1	000960978

96BP-CL

ball head offset hexagon key wrenches, chrome-plated, coloured



mm	L mm	L1 mm	€	5	000961600
1,5	91	16	2,73	5	000961600
2	102	17	3,05	5	000961601
2,5	113	21	3,40	5	000961602
3	128	23	3,75	5	000961603
4	143	28	4,20	5	000961604
5	163	33	4,50	5	000961605
6	185	37	5,80	5	000961606
8	206	43	7,90	2	000961608
10	231	50	10,50	2	000961610



96BP-CL/SC9	€ 50,00	1	000961619
1,5-2-2,5-3-4-5-6-8-10 mm			
96BP-CL/SCV	€ 4,00	1	000961629

96BPC

ball head offset hexagon key wrenches chrome-plated

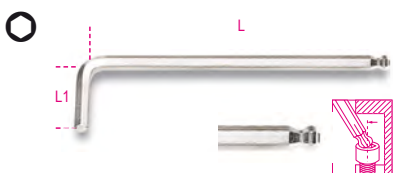

mm	L mm	L1 mm	€	10	000960340
1,5	79	13	2,06	10	000960340
2	84	15	2,17	10	000960341
2,5	89	17	2,28	10	000960342
3	99	19	2,44	10	000960343
4	108	24	2,78	10	000960344
5	126	27	3,40	10	000960345
6	148	31	4,80	10	000960346
7	157	33	6,35	5	000960353
8	168	35	6,45	5	000960347
10	187	39	10,50	5	000960348
12	220	55	13,40	5	000960352



96BPC/SC9	€ 41,00	1	000960354
1,5-2-2,5-3-4-5-6-8-10 mm			
96BPC/SCV	€ 4,00	1	000960984

96BP

ball head offset hexagon key wrenches burnished



mm	L mm	L1 mm	€	10	000960960
1,5	79	13	1,55	10	000960960
2	84	15	1,67	10	000960961
2,5	89	17	1,72	10	000960962
3	99	19	1,79	10	000960963
4	108	24	2,06	10	000960965
5	126	27	2,73	10	000960967
6	148	31	3,90	10	000960968
8	168	35	5,60	5	000960970
10	187	39	9,55	5	000960972
12	220	55	14,20	5	000960973



96BP/SC9	€ 34,50	1	000960974
1,5-2-2,5-3-4-5-6-8-10 mm			
96BP/SCV	€ 4,00	1	000960988

96LBP

ball head offset hexagon key wrenches, extra-long model

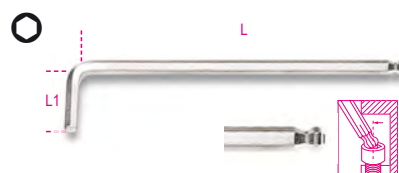

mm	L mm	L1 mm	€	5	000961340
1,5	90	15	2,39	5	000961340
2	100	17	2,52	5	000961341
2,5	112	20	2,67	5	000961342
3	127	22	2,78	5	000961343
4	144	27	3,45	5	000961344
5	163	32	4,10	5	000961345
6	184	37	5,65	5	000961346
8	204	44	7,75	2	000961348
10	230	49	12,40	2	000961350



96LBP/SC9	€ 47,50	1	000961354
1,5-2-2,5-3-4-5-6-8-10 mm			
96LBP/SCV	€ 4,00	1	000961984

96BP/AS

ball head offset hexagon wrenches
burnished

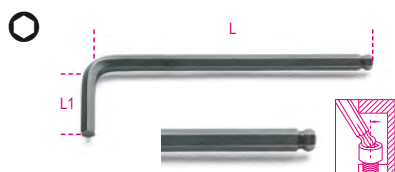

"	L mm	L1 mm	€	🔧	📄
3/32	89	17	1,89	10	000960989
1/8	98	18	2,01	10	000960990
5/32	108	24	2,39	10	000960991
3/16	126	26	2,73	10	000960992
7/32	139	28	3,95	10	000960993
1/4	152	31	4,35	10	000960994
5/16	168	34	5,70	5	000960995
3/8	190	39	9,45	5	000960996



96BP-AS/SC9 1/16-3/32-1/8-5/32-3/16 7/32-1/4-5/16-3/8	€ 37,50	🔧 1	📄 000961000
96BP-AS/SCV	€ 4,00	🔧 1	📄 000961001



96BP-AS/8 3/32-1/8-5/32-3/16-7/32 1/4-5/16-3/8	€ 34,00	🔧 1	📄 000960997
96BP-AS/BV	€ 1,79	🔧 1	📄 000960998

96BPA

ball head offset hexagon key wrenches, 110°,
extra-short side model



mm	L mm	L1 mm	€	🔧	📄
1,5	71	9	2,23	5	000961960
2	86	11	2,34	5	000961961
2,5	96	13	2,44	5	000961962
3	104	15	2,67	5	000961963
4	116	17	3,20	5	000961964
5	132	19	3,80	5	000961965
6	155	21	5,50	5	000961966
8	176	24	7,35	2	000961968
10	200	27	11,40	2	000961970



96BPA/SC9 1,5-2-2,5-3-4-5-6-8-10 mm	€ 45,00	🔧 1	📄 000961974
96BPA/SCV	€ 4,00	🔧 1	📄 000961988

96T

OFFSET HEXAGON KEY WRENCHES

with high torque handles

Rapid and easy to handle

The small-size handle is perfectly balanced to quickly rotate in the palm of the hand. The ergonomic shape allows extremely high torques to be applied.

The hexagon ends have been designed to transmit the maximum possible torque to the screw.

The round blade has a homogenous frame compared to the hexagon blade and provides increased strength.



Blade passes through handle

96T

offset hexagon key wrenches,
with high torque handles

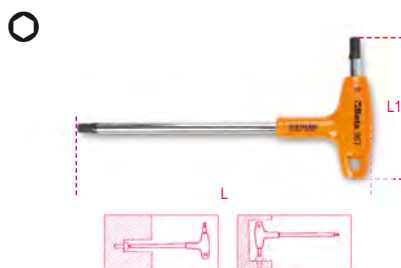

mm	L mm	L1 mm	€	🔧	📄
2	139	52	10,70	5	000960934
2,5	153	55	10,70	5	000960935
3	153	55	11,20	5	000960936
3,5	179	70	11,60	5	000960937
4	179	70	11,60	5	000960938
4,5	200	84	11,90	5	000960939
5	200	84	11,90	5	000960940
6	221	103	13,60	5	000960941
7	236	106	14,90	3	000960942
8	255	117	17,30	3	000960943
10	285	132	20,00	3	000960945



96T/S6 2-2,5-3-4-5-6 mm	€ 69,50	🔧 1	📄 000960952
96T/S8 2-2,5-3-4-5-6-8-10 mm	€ 107,00	🔧 1	📄 000960933
96T/S11 2-2,5-3-3,5-4-4,5-5-6-7-8-10 mm	€ 145,50	🔧 1	📄 000960951



96T/SP11 2-2,5-3-3,5-4-4,5-5 6-7-8-10 mm	€ 157,00	🔧 1	📄 000960957
96T/SPV 96T/S11 97TTX/S11	€ 32,50	🔧 1	📄 000960958

96T/AS

offset hexagon key wrenches,
with high torque handles

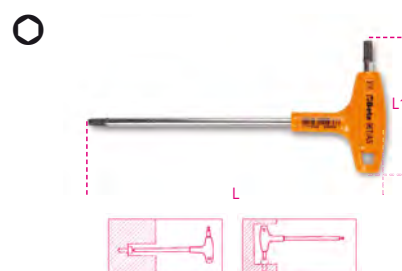

"	L mm	L1 mm	€	🔧	📄
3/32	153	55	13,30	2	000960669
7/64	153	55	13,30	2	000960670
1/8	179	70	13,50	2	000960671
9/64	179	70	14,10	2	000960672
5/32	200	84	14,10	2	000960673
3/16	200	84	14,10	2	000960674
7/32	221	103	15,70	2	000960675
1/4	236	106	17,50	2	000960676
5/16	255	117	20,00	2	000960678
3/8	285	132	23,60	2	000960680



96T/AS8 3/32-7/64-1/8-5/32-3/16- 1/4-5/16-3/8	€ 129,50	🔧 1	📄 000960682
96T/AS10 3/32-7/64-1/8-9/64-5/32 3/16-7/32-1/4-5/16-3/8	€ 159,00	🔧 1	📄 000960683

96TBP

ball head offset hexagon key wrenches with high torque handles

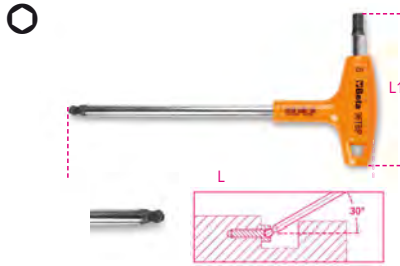

mm	L mm	L1 mm	€	🔧	📦
2,5	153	55	11,20	3	000960685
3	153	55	11,80	3	000960686
4	179	70	12,40	3	000960687
5	200	84	12,90	3	000960688
6	221	103	14,10	3	000960689
8	255	117	18,70	2	000960690
10	285	132	20,00	2	000960692



96TBP/S6 € 81,00 1 000960694
2,5-3-4-5-6-8 mm

97TX

offset key wrenches, for Torx® head screws



🔧	L mm	L1 mm	€	🔧	📦
T6	42	16	6,00	5	000970006
T7	48	16	6,00	5	000970007
T8	48	16	6,00	5	000970008
T9	48	16	6,55	5	000970009
T10	51	17	6,70	5	000970010
T15	54	18	6,70	5	000970015
T20	57	19	7,15	5	000970020
T25	60	20	7,35	5	000970025
T27	64	21	8,00	5	000970027
T30	70	24	8,00	5	000970030
T40	76	26	8,95	5	000970040
T45	83	29	10,70	5	000970045
T50	95	32	12,20	5	000970050
T55	108	35	15,50	5	000970055
T60	120	38	20,60	5	000970060



97TX/ST8 € 64,50 1 000970640
T9-T10-T15-T20-T25-T27-T30-T40



97TX/G8 € 50,50 1 000970645
T9-T10-T15-T20-T25-T27-T30-T40



97TX/BG8 € 40,00 1 000970368
T9-T10-T15-T20-T25-T27-T30-T40



97TX/SC8 € 63,50 1 000970064
T9-T10-T15-T20-T25-T27-T30-T40
97TX/SCV € 4,00 1 000970985



97TX/B13 € 102,00 1 000970650
T6-T7-T8-T9-T10-T15-T20-T25-T27-T30-T40-T45-T50
96N/BV € 1,79 1 000960651

97BTX

ball head offset key wrenches, for Torx® head screws

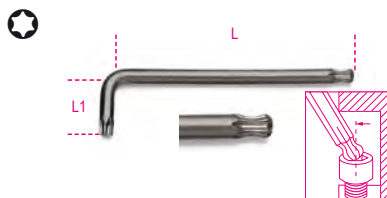

🔧	L mm	L1 mm	€	🔧	📦
T9	62	16	7,60	5	000970109
T10	71	17	7,60	5	000970110
T15	81	18	7,60	5	000970115
T20	92	19	8,20	5	000970120
T25	94	20	8,70	5	000970125
T27	105	21	9,30	5	000970127
T30	114	24	9,40	5	000970130
T40	129	26	10,80	5	000970140
T45	133	28	12,70	5	000970145
T50	152	32	14,20	3	000970150
T55	164	35	20,30	3	000970155



97BTX/SC8 € 73,00 1 000970164
T9-T10-T15-T20-T25-T27-T30-T40
97BTX/SCV € 4,00 1 000970983



97BTX/B8 € 71,00 1 000970159
T9-T10-T15-T20-T25-T27-T30-T40
96N/BV € 1,79 1 000960651

97BTX-C

ball head offset key wrenches, for Torx® head screws, coloured



🔧	L mm	L1 mm	€	🔧	📦
T9	80	16	8,45	5	000971609
T10	86	17	8,45	5	000971610
T15	90	18	8,45	5	000971615
T20	95	19	9,15	5	000971620
T25	100	20	9,85	5	000971625
T27	105	21	10,40	5	000971627
T30	114	24	10,70	5	000971630
T40	124	26	11,80	5	000971640



97BTX-C/SC8 € 81,00 1 000971658
T9-T10-T15-T20-T25-T27-T30-T40
97BTX-C/SCV € 4,00 1 000971659



97BTXL

ball head offset key wrenches, long model, for Torx® head screws



	L mm	L1 mm	€	🔧	📄
T9	80	15	8,00	3	000970309
T10	86	17	8,00	3	000970310
T15	100	18	8,00	3	000970315
T20	110	19	9,15	3	000970320
T25	126	20	10,10	3	000970325
T27	140	24	11,30	3	000970327
T30	160	28	11,80	3	000970330
T40	176	32	14,00	3	000970340



97BTXL/SC8 T9-T10-T15-T20- T25-T27-T30-T40	€ 84,50	🔧 1	📄 000970364
97BTXL/SCV	€ 4,00	🔧 1	📄 000970982

97RTX

offset key wrenches for Tamper Resistant Torx® head screws



⊕	L mm	L1 mm	€	🔧	📄
T6	40	15	7,25	5	000970206
T7	45	15	7,25	5	000970207
T8	50	16	7,25	5	000970208
T9	56	16	7,25	5	000970209
T10	62	17	7,25	5	000970210
T15	72	17	7,25	5	000970215
T20	83	18	7,45	5	000970220
T25	90	18	7,65	5	000970225
T27	100	20	8,55	5	000970227
T30	105	24	8,65	5	000970230
T40	112	26	9,55	5	000970240
T45	118	26	11,20	5	000970245
T50	122	28	14,50	3	000970250
T55	128	30	16,70	3	000970255



97RTX/SC8 T9-T10-T15-T20-T25 T27-T30-T40	€ 67,50	🔧 1	📄 000970263
97RTX/SCV	€ 4,00	🔧 1	📄 000970984



97RTX/B8 T9-T10-T15-T20-T25 T27-T30-T40	€ 65,50	🔧 1	📄 000970260
96N/BV	€ 1,79	🔧 1	📄 000960651

97TTX

offset key wrenches with handles for Torx® head screws



⊕	L mm	L1 mm	€	🔧	📄
T6	130	52	11,00	3	000970706
T7	130	52	11,00	3	000970707
T8	139	52	11,10	3	000970708
T9	139	52	11,10	3	000970709
T10	179	70	11,40	3	000970710
T15	179	70	12,30	3	000970715
T20	179	70	12,80	3	000970720
T25	179	70	13,60	3	000970725
T27	200	84	14,90	3	000970727
T30	200	84	15,40	3	000970730
T40	221	103	18,40	3	000970740
T45	236	106	21,50	2	000970745
T50	255	117	27,50	2	000970750



97TTX/S6 T10-T15-T20-T25-T30-T40	€ 84,00	🔧 1	📄 000970791
97TTX/S8 T8-T10-T15-T20-T25- T27-T30-T40	€ 110,00	🔧 1	📄 000970808
97TTX/S11 T8-T9-T10-T15-T20-T25 T27-T30-T40-T45-T50	€ 170,00	🔧 1	📄 000970800
97TTX/S13 T6-T7-T8-T9-T10-T15-T20-T25 T27-T30-T40-T45-T50	€ 192,00	🔧 1	📄 000970813



97TTX/SP11 T8-T9-T10-T15-T20-T25 T27-T30-T40-T45-T50	€ 181,50	🔧 1	📄 000970840
96T/SPV 96T/S11 97TTX/S11	€ 32,50	🔧 1	📄 000960958

98KZN

offset key wrenches with XZN® profile



DIN 65253

⊕	L mm	L1 mm	€	🔧	📄
M5	83	25	5,20	5	000980005
M6	89	30	5,95	5	000980006
M8	97	32	7,50	5	000980008
M10	106	35	9,90	5	000980010
M12	116	37	12,50	5	000980012
M14	118	45	15,80	5	000980014
M16	125	45	23,40	5	000980016



98KZN/B5 M5-M6-M8-M10-M12	€ 43,00	🔧 1	📄 000980650
96N/BV	€ 1,79	🔧 1	📄 000960651

99

hook wrenches with square noses, for ring nuts UNI/ISO 2982, 2983



UNI 6752

⊕ mm	A mm	€	🔧	📄
12-14	1,5	10,00	3	000990012
16-18-20	1,8	10,00	3	000990016
22-25-28	1,8	13,30	3	000990022
30-32	2,1	13,30	3	000990030
34-36-38	2,4	16,20	3	000990034
40-42	2,4	16,20	3	000990040
45-50	2,5	20,10	3	000990045
52-55-58	2,5	20,10	3	000990052
62-65	3,1	25,50	3	000990062
68-70-75	3,1	25,50	3	000990068
80-85-90	3,8	34,00	2	000990080
92-95	4,3	34,00	2	000990092
98-100	4,3	34,00	2	000990098
105-110-115	4,4	53,50	1	000990105
120-125-130	4,9	53,50	1	000990120
135-145	6,0	78,50	1	000990135
155-165	6,0	78,50	1	000990155

99SQ

hook wrenches with square noses for ring nuts



⊕ mm	B mm	€	🔧	📄
15-35	2,7	27,00	2	000990215
35-50	3,5	30,50	2	000990235
50-80	4,7	40,00	2	000990250
80-120	6,2	55,00	2	000990280
120-180	7,8	73,50	2	000990290

99ST

hook wrenches with round noses
for ring nuts



Ø mm	Ø mm	B mm	€	🔧	📦
15-35	3,0	2,5	27,50	2	000990315
35-50	4,0	4,5	32,50	2	000990335
50-80	5,0	5,0	43,50	2	000990350
80-120	6,0	7,0	59,00	2	000990380
120-180	8,0	9,0	76,50	2	000990390

99 VN/...

spare nose for item 99ST

	Ø mm	€	🔧	📦
99ST VN/15	15-35	7,55	1	000990295
99ST VN/35	35-50	8,65	1	000990296
99ST VN/50	50-80	10,70	1	000990297
99ST VN/80	80-120	12,30	1	000990298
99ST VN/120	120-180	16,20	1	000990299

100

round pin wrench for ring nuts
with front holes



Ø mm	L mm	Ø min-max mm	€	🔧	📦
4,9-5,9	250	18÷100	141,00	1	001000001
6,9-7,9					

100/KIT

spare pins for item 100



	€	🔧	📦
100/KIT	43,50	1	001000010

111

adjustable wrenches with scales, chrome-plated

- Right-hand rotation of pin
- With mm and inch scale



DIN 3117 ISO 6787

L mm	L "	A max mm	€	🔧	📦
100	4	15	22,20	3	001110010
150	6	24	23,00	3	001110015
200	8	28	28,00	3	001110020
250	10	34	34,50	3	001110025
300	12	35	45,50	3	001110030
380	15	45	89,00	3	001110038
450	18	54	148,00	2	001110045
600	24	62	205,00	1	001110060

111N

adjustable wrenches with scales, phosphatized

- Left-hand rotation of pin
- With mm and inch scale



DIN 3117 ISO 6787

L mm	L "	A max mm	€	🔧	📦
100	4	15	20,40	3	001110210
150	6	24	21,50	3	001110215
200	8	28	25,00	3	001110220
250	10	34	31,00	3	001110225
300	12	35	42,00	3	001110230
380	15	45	82,00	3	001110238
450	18	54	140,00	2	001110245

111G

adjustable wrenches with scales
chrome-plated

- Right-hand rotation of pin
- Mm and inch scale
- Ergonomic handle



DIN 3117 ISO 6787

L mm	L "	A max mm	€	🔧	📦
200	8	28	34,00	3	001110620
250	10	34	41,50	3	001110625
300	12	35	54,50	2	001110630

120

ratchet opening single ended
bi-hex wrenches

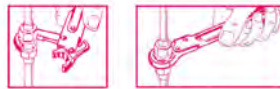

Ø mm	L mm	€	🔧	📦
10	135	44,50	1	001200010
11	135	44,50	1	001200011
12	135	44,50	1	001200012
13	135	44,50	1	001200013
14	135	50,50	1	001200014
17	185	54,50	1	001200017
19	185	58,00	1	001200019
22	230	78,50	1	001200022
24	230	84,50	1	001200024
27	230	107,00	1	001200027
30	320	122,00	1	001200030
32	320	129,00	1	001200032

Beta
Quality Tools



	€	🔧	📦
120/B6N 10-11-13 17-19-22 mm	334,00	1	001200060
2002/BVL6	9,65	1	020020010

123E1/4

bit holder adaptor, 1/4", for 10 mm ratcheting
wrenches

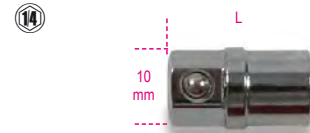

Ø mm	L mm	€	🔧	📦
10	20,6	6,00	1	001230010

123Q1/4

quick release adaptor, 1/4", for 10 mm
ratcheting wrenches



Ø mm	L mm	€	🔧	📦
10	17,5	8,35	1	001230310

123Q3/8

quick release adaptor, 3/8", for 13 mm
ratcheting wrenches

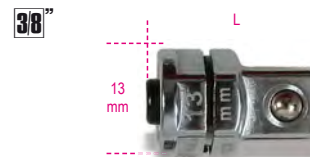

Ø mm	L mm	€	🔧	📦
13	22,5	8,45	1	001230313

123Q1/2

quick release adaptor, 1/2", for 19 mm
ratcheting wrenches



Ø mm	L mm	€	🔧	📦
19	30,5	8,95	1	001230319

123/K4

kit with 4 adapters for ratchet wrenches:
1 bit adapter
3 quick release adapters



123/K4	€ 31,50	1	001230504
--------	---------	---	-----------

141

ratcheting combination wrenches, straight series



ISO 21982:2020

mm	L mm	€		
8x8	136	15,00	3	001410008
9x9	143	15,70	3	001410009
10x10	160	16,20	3	001410010
11x11	168	16,50	3	001410011
12x12	174	17,10	3	001410012
13x13	180	18,60	3	001410013
14x14	193	19,40	2	001410014
15x15	200	20,30	2	001410015
16x16	216	22,20	2	001410016
17x17	233	23,00	2	001410017
18x18	239	23,90	2	001410018
19x19	250	24,50	2	001410019



141/B6	€ 125,00	1	001410066
8-10-13-14-17-19 mm			
141/B9	€ 180,50	1	001410069
8-10-11-12-13-14-15-17-19 mm			



141/S12	€ 232,50	1	001410072
8-9-10-11-12-13-14-15-16-17-18-19 mm			

142

RATCHETING WRENCHES

The rapid 72-tooth ratchet provides a take-up angle of no more than 5°, thereby resulting in quick, accurate tightening.

1 The fixed mouth makes strong tightening possible, based on the long shank.

2 The built-in reversing lever avoids any risk of accidental reversal.



3 The bi-hex ring end is angled at 15°, to protect the hand and allow easier access.

4 The fixed head is angled at 15° to the axis, thereby resulting in a reduced take-up angle.



142

reversible ratcheting combination wrenches



ISO 21982:2020

mm	L mm	€		
6x6	136	16,50	3	001420006
7x7	136	16,50	3	001420007
8x8	136	17,00	3	001420008
9x9	143	18,20	3	001420009
10x10	159	18,70	3	001420010
11x11	168	19,30	3	001420011
12x12	174	20,00	3	001420012
13x13	180	21,50	3	001420013
14x14	190	22,20	2	001420014
15x15	200	23,50	2	001420015
16x16	216	25,50	2	001420016
17x17	233	26,00	2	001420017
18x18	239	28,00	2	001420018
19x19	248	28,50	2	001420019
21x21	285	37,00	1	001420021
22x22	285	38,50	1	001420022
24x24	325	44,50	1	001420024
27x27	355	64,50	1	001420027
30x30	420	75,50	1	001420030
32x32	420	78,00	1	001420032
34x34	482	109,00	1	001420034
36x36	482	110,00	1	001420036
38x38	482	112,50	1	001420038



142/B6	€ 142,00	1	001420066
8-10-13-14-17-19 mm			
142/BV6	€ 8,35	1	001420076
142/B9	€ 206,50	1	001420069
8-10-11-12-13-14-15-17-19 mm			
142/BV9	€ 10,00	1	001420079



142/S15	€ 340,00	1	001420074
6-7-8-9-10-11-12-13-14-15-16-17-18-19-22 mm			
142/S17	€ 468,00	1	001420068
6-7-8-10-11-12-13-14-15-16-17-18-19-21-22-24-27 mm			
142/S19	€ 602,00	1	001420075
6-7-8-9-10-11-12-13-14-15-16-17-18-19-22-24-27-30-32 mm			

142/SC9I-E

set of 9 reversible ratcheting combination wrenches, with compact support



142/SC9I	€ 204,50	1	001420087
8-10-11-12-13-14-15-17-19 mm			
142/SCV9I	€ 9,45	1	001420103
142/SC9E	€ 212,00	1	001420088
8-10-11-12-13-16-17-18-19 mm			
142/SCV9E	€ 9,45	1	001420104

142MC

reversible ratcheting combination wrenches, coloured



ISO 21982:2020

mm	L mm	€		
8x8	136	17,90	3	001422008
10x10	159	19,60	3	001422010
11x11	168	20,10	3	001422011
12x12	174	20,90	3	001422012
13x13	180	22,50	3	001422013
14x14	190	23,40	2	001422014
15x15	200	24,50	2	001422015
16x16	216	27,00	2	001422016
17x17	233	27,50	2	001422017
18x18	239	29,00	2	001422018
19x19	248	30,00	2	001422019



142MC/SC9I	€ 214,00	1	001422087
8-10-11-12-13-14-15-17-19 mm			
142MC/SC9E	€ 222,00	1	001422088
8-10-11-12-13-16-17-18-19 mm			

142AS

reversible ratcheting combination wrenches



mm	L mm	€	1	001420308
5/16x5/16	136	20,10	2	001420308
3/8x3/8	159	20,60	2	001420310
7/16x7/16	168	21,70	2	001420311
1/2x1/2	180	24,30	2	001420313
9/16x9/16	190	24,80	2	001420314
5/8x5/8	216	27,50	2	001420316
11/16x11/16	233	28,00	2	001420317
3/4x3/4	248	31,00	2	001420319



142AS/8	€ 198,00	1	001420330
5/16-3/8-7/16-1/2 9/16-5/8-11/16-3/4			

142C

ratcheting combination wrenches, straight short series



ISO 21982:2020

mm	L mm	€	2	001420108
8x8	88	12,30	2	001420108
9x9	96	12,30	2	001420109
10x10	96	12,80	2	001420110
11x11	100	13,60	2	001420111
12x12	104	14,40	2	001420112
13x13	108	15,00	2	001420113
14x14	114	15,70	2	001420114
15x15	118	16,30	2	001420115
16x16	122	16,80	2	001420116
17x17	128	18,20	2	001420117
18x18	132	19,60	2	001420118
19x19	138	20,10	2	001420119



142C/A12	€ 211,50	1	001420175
8-9-10-11-12-13-14 15-16-17-18-19 mm			

142SN

swivel end ratcheting combination wrenches



ISO 21982:2020

mm	L mm	€	2	001420207
7x7	136	19,80	2	001420207
8x8	136	20,60	2	001420208
9x9	143	21,40	2	001420209
10x10	160	22,60	2	001420210
11x11	168	23,60	2	001420211
12x12	174	24,40	2	001420212
13x13	180	26,00	2	001420213
14x14	193	27,00	2	001420214
15x15	200	28,50	2	001420215
16x16	216	30,50	2	001420216
17x17	233	31,00	2	001420217
18x18	239	33,50	2	001420218
19x19	250	34,00	2	001420219
22x22	285	40,00	1	001420222
24x24	325	45,00	1	001420224



142SN/S13	€ 343,00	1	001420263
7-8-9-10-11-12-13-14 15-16-17-18-19 mm			



142SN/SC9	€ 245,50	1	001420259
8-10-11-12-13-14-15-17-19 mm			

186

self-locking wrench with automatic take-up device for hexagons, 8 to 32 mm

Ideal for hexagon, Spline, square and Torx® head screws, including damaged screws.



L mm	€	1	001860008
260	46,50		

187

swivelling, openable wrenches



mm	L mm	€	1	001870008
8x9	125	31,00	1	001870008
10x11	155	33,50	1	001870010
12x13	175	34,50	1	001870012
14x15	205	37,50	1	001870014
16x17	235	43,00	1	001870016



187/B5	€ 189,50	1	001870050
8x9-10x11-12x13 14x15-16x17 mm			

188

ratcheting flat bi-hex ring wrenches for free alternator pulleys



mm	L mm	€	2	001880010
10	240	21,10	2	001880010
15	322	29,00	2	001880015

192

reversible ratcheting double-ended flat bi-hex ring wrenches, 4 in 1



mm	L mm	€	1	001920008
8x10/12x13	160	27,00	1	001920008
16x17/18x19	230	35,00	1	001920016



192/S2	€ 62,00	1	001920070
8x10/12x13 mm 16x17/18x19 mm			

194
reversible ratcheting wrench
for bits



1/4x5/16	L mm	€	2	001940006
	128	35,00		

195
ratcheting double-ended flat bi-hex ring
wrenches



ISO 21982:2020

mm	L mm	€		
8x10	128	18,90	2	001950010
12x13	170	21,70	2	001950013
14x15	190	22,80	2	001950015
16x18	230	26,50	2	001950018
17x19	230	28,00	2	001950019



195/B5	€ 128,00	1	001950066
8x10-12x13-14x15 16x18-17x19 mm			
195/BV5	10,00	1	001950070

195AS
ratcheting double-ended flat bi-hex ring
wrenches



mm	L mm	€		
5/16x3/8	128	19,60	2	001950606
7/16x1/2	170	21,70	2	001950611
9/16x5/8	190	24,50	2	001950614
11/16x3/4	230	27,50	2	001950617



195AS/B4	€ 103,50	1	001950654
5/16x3/8 - 7/16x1/2 - 9/16x5/8 - 11/16x3/4			
195FTX/BV4	10,00	1	001950520

195P
reversible ratcheting double-ended offset
bi-hex ring wrenches, bent at 15°



ISO 21982:2020

mm	L mm	€		
8x10	128	28,50	2	001950210
12x13	170	30,50	2	001950213
14x15	190	31,50	2	001950215
16x18	230	35,50	2	001950218
17x19	230	37,00	2	001950219



195P/B5	€ 173,00	1	001950266
8x10-12x13-14x15 16x18-17x19 mm			
195/BV5	10,00	1	001950070

310
polywelder for PE, PP, PVC
and PVDF pipes and fittings

CE



230V-650 Watt
50 Hz±60Hz
Schuko (CEE 7/7)

	Ø mm	€		
310/1	16÷50	256,00	1	003100001
310/2	16÷63	358,00	1	003100002

310B
forms for polywelder item 310



Ø mm	€		
16	61,00	1	003100016
20	67,00	1	003100020
25	71,50	1	003100025
32	79,00	1	003100032
40	93,50	1	003100040
50	118,00	1	003100050
63	136,00	1	003100063



Beta

310/C4
polywelder with assortment of 3 forms



310/C4	€ 513,00	1	003100104
310/1+310B: Ø 20-25-32			
410x260x82 mm - 4,8 kg			

310/C8
polywelder with assortment of 7 forms



310/C8	€ 803,00	1	003100108
310/2+310B: Ø 16-20-25 32-40-50-63			
440x270x120 mm - 7,7 kg			

311
heating plates for manual straight
and slanted welding of PE, PP, PVC
and PVDF pipes

CE



230V
50 Hz±60Hz
Schuko (CEE 7/7)

	Ø mm	Watt	€		
311/1	120	300	318,00	1	003110001
311/2	190	900	354,00	1	003110002

FIELD OF USE OF BETA'S PIPE CUTTERS

Beta's pipe cutters cover a wide range of applications. They rely on accurate, smooth rollers and screw or telescopic feed to make accurate, clean cuts possible on all the materials used for pipes.

The table below shows the pipe cutter / cutter wheel combinations for each material.

STEEL GAS PIPES				STAINLESS STEEL GAS PIPES			
	10 mm	60 mm	115 mm	10 mm	60 mm	115 mm	
	1/8"	2"	4"	1/8"	2"	4"	
330/2							
330/4							

COPPER AND LIGHT ALLOY PIPES							
	3 mm	6 mm	8 mm	16 mm	30 mm	38 mm	67 mm
	1/8"	1/4"	5/16"	5/8"	1"1/8"	1"1/2"	2"5/8"
331L							
332							
334							
336							
338							

THIN-WALLED STAINLESS STEEL PIPES							
	3 mm	6 mm	8 mm	16 mm	30 mm	38 mm	67 mm
	1/8"	1/4"	5/16"	5/8"	1"1/8"	1"1/2"	2"5/8"
332 + 334R/I							
334 + 334R/I							
336 + 338R/I							
338 + 338R/I							

PLASTIC PIPES								
	6 mm	8 mm	16 mm	30 mm	38 mm	50 mm	67 mm	127 mm
	1/4"	5/16"	5/8"	1"1/8"	1"1/2"	2"	2"5/8"	5"
336 + 338RP								
338 + 338RP								
339A								

330

pipe cutters for steel gas pipes



	Ø mm - "	L mm	€		
330/2	10÷60 1/8"÷2"	380	149,00	1	003300002
330/4	60÷115 2"÷4"	585	339,00	1	003300004

330R/A

spare cutters for item 330 wheels for steel pipes



	Ø mm	S mm	€		
330R/A2	32	7	14,30	1	003300012
330R/A4	42	9	37,00	1	003300014

330R/I

spare cutter wheel for item 330 for stainless steel pipes



	Ø mm	S mm	€		
330R/I2	32	7	32,00	1	003300024
330R/I4	32	9	89,50	1	003300034

332

mini pipe cutter for copper and light alloy pipes



	Ø mm - "	L mm	€		
332	3÷16 1/8"÷5/8"	59	21,50	2	003320001

334

pipe cutter for copper and light alloy pipes



	Ø mm - "	L mm	€		
334	3÷30 1/8"÷1"1/8"	150	29,50	1	003340001

334R

spare cutter wheel for items 332 and 334 for copper and light alloy pipes

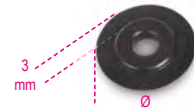

	Ø mm	€		
334R	18	6,35	1	003340021

334R/I

spare cutter wheel for items 332 and 334 for stainless steel pipes

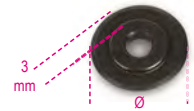

	Ø mm	€		
334R/I	18	18,00	1	003340023

336

telescopic pipe cutter for copper and light alloy pipes



	Ø mm - "	L mm	€		
336	6÷38 1/4"÷2"1/2"	160	49,00	1	003360001

338

telescopic pipe cutter, fast advance for copper, light alloys and plastic pipes



	Ø mm - "	L mm	€		
338	6÷67 1/4"÷2"5/8"	290	122,00	1	003380001

338R

spare cutter wheel for items 331L, 336 and 338 for copper and light alloy pipes



338R	Ø mm	€		
	18,5	6,70	1	003380022

338R/I

spare cutter wheel for items 336 and 338 for stainless steel pipes



338R/I	Ø mm	€		
	21,8	20,00	1	003380023

338RP

spare cutter wheel for items 336 and 338 for plastic pipes



338RP	Ø mm	€		
	21,9	7,30	1	003380025

339A

telescopic pipe cutter, fast advance for plastic pipes



	Ø mm - "	L mm	€		
	50÷127 2"÷ 5"	345	260,00	1	003390011

339A/R

spare cutter wheels for item 339A

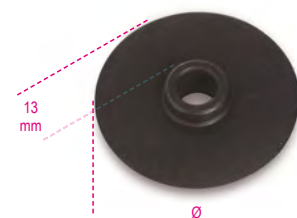

339A/R	Ø mm	€		
	42	18,00	1	003390061

340

multilayer pipe cutting pliers, max. Ø 26 mm
PTFE-coated blade
4 support rollers making it easier to rotate pipe during cutting jobs
system for cutting corrugated pipes built into handle
lightweight magnesium body



	Ø max mm	€		
	26	101,50	1	003400001

340RL

spare blade for item 340



340RL	€		
	28,50	1	003400010

340C

corrugated pipe cutting pliers

- pliers made of alloy aluminium and magnesium
- compact, pocket-size, lightweight
- additional blade for lengthwise cutting



	Ø mm	L mm	€		
	14-45	134	48,00	1	003400050

340C/KRL

kit of 3 spare blades for 340C



340C/KRL	€		
	28,50	1	003400055

341

pipe cutting pliers for plastic pipes



	Ø mm	L mm	€		
	0÷25	190	36,00	1	003410001

341RL

spare blade for item 341



341RL	€		
	15,20	1	003410010

341B

ratchet-type shears for plastic pipes



	Ø mm	L mm	€		
	0÷35	195	66,00	1	003410051

341B/RM

spare spring for item 341B

341B/RM	€		
	2,49	1	003410061

341B/RL

spare blade for item 341B



341B/RL	€		
	23,90	1	003410060

342

Ratchet-type shears for plastic pipes



∅ mm - "	L mm	€			
0÷42 1"5/8	200	48,50	1		003420030

342MOL

spare spring for item 342

342MOL	€				
	3,50	1			003420033

342RL

spare blade for item 342



342RL	€				
	22,20	1			003420032

342A

ratchet-type shears for plastic pipes



∅ mm - "	L mm	€			
0÷50 2"	270	99,00	1		003420101

342A/MOL

spare spring for item 342A

342A/MOL	€				
	2,15	1			003420111

342A/RL

spare blade for item 342A



342A/RL	€				
	51,50	1			003420110

342P

ratchet-type shears for plastic pipes, made from magnesium alloy



∅ mm - "	L mm	€			
0÷50 2"	260	107,50	1		003420121

342P/RL

spare blade for item 342P



342P/RL	€				
	45,00	1			003420130

345

pipe reamer metal body



∅ mm - "	L mm	€			
3÷42 1/8"÷1"5/8	58	26,50	5		003450001

345U

pipe reamer for stainless steel, steel, copper and light alloys



∅ mm - "	L mm	€			
4÷36 5/32÷1"7/16	60	70,00	1		003450050

345U/A

adapter for pipe reamer 345U, 1/4" hexagon drive, for power drivers



L mm	€				
90	17,90	3			003450055

345C

multilayer pipe gauge



∅ mm	€				
16-20-26-32	42,50	1			003450032

345SB

deburrer with revolving replacement blade



L mm	€				
150	21,90	5			003450010

345SB/R

spare blade for item 345SB



345SB/R	€				
	7,70	3			003450015

349

tube flaring tool with clutch, for copper and light alloy pipes



∅ mm - "	€				
6-8-10-12-14-15-16-18 (1/8-3/16-1/4-5/16 3/8-1/2-5/8-3/4)	264,00	1			003490001

≡ 270x200x50 mm - 2,7 kg

349/SMM

metric slide for item 349



∅ mm	€				
6-8-10-12-14-15-16-18	77,00	1			003490011

349/SMAS

inch slide for item 349



1/8-3/16-1/4-5/16 3/8-1/2-5/8-3/4	€	73,00	1	003490012
--------------------------------------	---	-------	---	-----------

350

tube flaring tool for copper and light alloy pipes



∅ mm 4-4,75-6-8 10-12-14	L mm 175	A mm 104	€	76,50	1	003500001
--------------------------------	-------------	-------------	---	-------	---	-----------

351C

pipe cutter and tube flaring tool



351C	€	138,50	1	003510010
------	---	--------	---	-----------

334	∅ 3+30 mm (1/8"+1"1/8)
350	∅ 4+14 mm
351P	∅ 4-4,75-6-8-10-12-14 mm

225x150x45 mm - 1,6 kg

351P

inserts for tube flaring tool item 350



351P 4	∅ mm 4	€	6,35	3	003510101
351P 4,75	4,75	6,35	3	003510102	
351P 6	6	6,35	3	003510103	
351P 8	8	6,35	3	003510104	
351P 10	10	6,35	3	003510105	
351P 12	12	6,35	3	003510106	
351P 14	14	6,35	3	003510107	

352U

adjustable tube flaring tool for copper and light alloy pipes



∅ mm - " 5÷16 3/16÷5/8	A mm 130	€	91,00	1	003520101
------------------------------	-------------	---	-------	---	-----------

352C/U

pipe cutter, deburrer and adjustable tube flaring tool



352C/U	€	178,50	1	003520110
--------	---	--------	---	-----------

334 ∅ 3+30 mm (1/8"+1"1/8)

345SB

352U ∅ 5+16 mm (3/16"+5/8")

335x145x60 mm - 2120 g

353N

tube expanding pliers, with interchangeable forms



L mm 380	€	356,00	1	003530201
-------------	---	--------	---	-----------

353NM

forms for tube expanding pliers item 353N



∅ mm	A mm	€		
10	7	121,50	1	003530210
12	10	121,50	1	003530212
14	10	121,50	1	003530214
16	12	121,50	1	003530216
18	12	121,50	1	003530218
22	13	121,50	1	003530222

353N/C6

tube expanding pliers item 353N with forms item 353NM



353N/C6	€	1.129,00	1	003530300
---------	---	----------	---	-----------

353N

353NM ∅ 10-12-14-16-18-22 mm

420x185x60 mm - 2,2 kg

355

combination spud wrench, five steps



∅ " 3/8"-1/2" 3/4"-1"	L mm 90	€	36,00	2	003550001
-----------------------------	------------	---	-------	---	-----------

357F3

three-vial spirit level

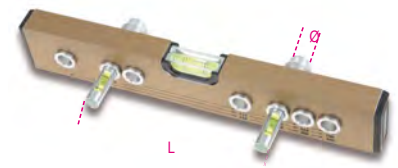

∅ " 3/8" / 1/2"	L mm 90÷220	€	114,50	1	003570100
--------------------	----------------	---	--------	---	-----------

357R/F3

spare vial for item 357F3



357R/F3	€	18,50	1	003570101
---------	---	-------	---	-----------

358

tools for chamfering plastic pipes



	Ø mm	€		
358/1	16÷110	161,00	1	003580001
358/2	40÷250	161,00	1	003580002

358RL

spare blade for items 358/1 and 358/2



358RL	€		
	29,50	1	003580011

359

universal drain wrench



Ø "	L mm	A mm	€		
1"÷1 1/4"	160	140	79,00	1	003590001

359CH

drain adaptor, cross-shape for item 359



Ø "	L mm	€		
1 1/2"	74	45,00	1	003590005

360

pipe wrenches, Stillson pattern



L mm	Ø max "	Ø max mm	€		
250	1" gas	34	34,00	1	003600025
350	1 1/2" gas	49	45,00	1	003600035
450	2" gas	60	63,00	1	003600045
600	2 1/2" gas	76	96,00	1	003600060
900	3 1/2" gas	102	267,00	1	003600090

360R/...

spare parts kit for item 360
with moving jaw and ring nut.

	€		
360R250	12,70	1	003600225
360R350	17,40	1	003600235
360R450	24,80	1	003600245
360R600	37,00	1	003600260
360R900	66,50	1	003600290

362

heavy duty pipe wrenches



L mm	Ø max "	Ø max mm	€		
200	1" gas	34	29,50	1	003620020
250	1 1/2" gas	49	37,50	1	003620025
300	2" gas	60	45,00	1	003620030
350	2" gas	60	54,00	1	003620035
450	2 1/2" gas	76	77,00	1	003620045
600	3" gas	90	117,00	1	003620060
900	5" gas	140	144,00	1	003620090

362R/...

spare parts kit for item 362
with: fixed jaw, moving jaw; ring nut; lockpin.

	€		
362R 200	6,25	1	003620220
362R 250	8,85	1	003620225
362R 300	11,00	1	003620230
362R 350	12,70	1	003620235
362R 450	17,30	1	003620245
362R 600	23,10	1	003620260
362R 900	57,50	1	003620290

363

heavy duty pipe wrenches
made from light alloy



L mm	Ø max "	Ø max mm	€		
350	2" gas	60	65,00	1	003630035
450	2 1/2" gas	76	87,00	1	003630045
600	3" gas	90	147,00	1	003630060
900	5" gas	140	275,00	1	003630090
1200	6" gas	165	292,00	1	003630120

363R/...

spare parts kit for item 363
with: fixed jaw; moving jaw; ring nut; lockpin.

	€		
363R 350	13,90	1	003630235
363R 450	18,50	1	003630245
363R 600	25,50	1	003630260
363R 900	50,50	1	003630290
363R 1200	77,50	1	003630320

365

heavy duty pipe wrenches,
offset pattern made from light alloy

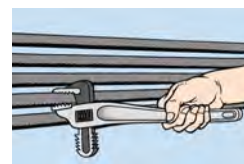

L mm	Ø max "	Ø max mm	€		
350	2" gas	60	80,50	1	003650035
450	2 1/2" gas	76	111,00	1	003650045

365R/...

spare parts kit for item 365
with: fixed jaw; moving jaw; ring nut; lockpin.

	€		
365R 350	60,50	1	003650235
365R 450	90,00	1	003650245

366

pipe wrenches, light pattern



L mm	Ø max "	Ø max mm	€		
175	1" gas	34	30,50	1	003660017
225	1 1/2" gas	49	36,00	1	003660022
275	2" gas	60	44,00	1	003660027
300	2 1/2" gas	76	47,50	1	003660030
350	3" gas	90	54,00	1	003660035

374

pipe wrenches,
Swedish pattern, 45° slim jaws



DIN 5234

L mm	Ø max "	Ø max mm	€		
240	1 1/2" gas	21	35,50	1	003740024
320	1" gas	34	47,50	1	003740032
410	1 1/2" gas	49	62,50	1	003740041
550	2" gas	60	97,00	1	003740055
630	3" gas	90	173,50	1	003740063

375

pipe wrench, Swedish pattern,
45° flat jaws



DIN 5234

L	∅	∅	€		
mm	max"	max mm			
320	1" gas	34	47,50	1	003750032
410	1 1/2" gas	49	62,50	1	003750041
550	2" gas	60	97,00	1	003750055

376

pipe wrenches,
Swedish pattern, 90° flat jaws



DIN 5234

L	∅	∅	€		
mm	max"	max mm			
320	1" gas	34	47,50	1	003760032
410	1 1/2" gas	49	62,50	1	003760041
550	2" gas	60	97,00	1	003760055
630	3" gas	90	176,00	1	003760063

378

pipe wrenches,
Swedish pattern, 45° slim jaws



DIN 5234

L	∅	∅	€		
mm	max"	max mm			
250	1/2" gas	21	37,50	1	003780025
320	1" gas	34	50,00	1	003780032
410	1 1/2" gas	49	65,00	1	003780041
550	2" gas	60	106,50	1	003780055
650	3" gas	90	179,50	1	003780065

374R/...

complete spare parts kit for items 374 - 375 -
376 - 378
with ring nut and ring nut stop

	€		
374R 240 x 374/240-378/250	2,10	1	003740724
374R 320 x 374/320-376/320-378/320	2,33	1	003740732
374R 410 x 374/410-375/410-376/410-378/410	2,56	1	003740741
374R 550 x 374/550-376/550-378/550	3,45	1	003740755
374R 630 x 374/630-378/650	5,25	1	003740763

383

reversible strip pipe wrenches



	∅	∅ max	L	€		
	max"	mm	mm			
383/1	3" gas	90	300	51,00	1	003830001
383/2	8" gas	220	300	54,00	1	003830002

383R

spare strips for item 383



	S	€		
	mm			
383R/1	27	20,70	1	003830010
383R/2	27	21,80	1	003830015

384

reversible chain pipe wrench



∅	∅	L	€		
max"	max mm	mm			
4" gas	115	300	69,00	1	003840032

384RC

spare chain for item 384



	€		
384RC	42,50	1	003840033

386A

heavy duty reversible
chain pipe wrenches



	∅	L	€		
	max	mm			
386A/3	4" gas 115 mm	900	233,00	1	003860003
386A/4	6" gas 168 mm	900	431,00	1	003860004
386A/5	8" gas 220 mm	1100	556,00	1	003860005
386A/6	12" gas 324 mm	1300	966,00	1	003860006

386A/RC

spare chains for item 386A



	€		
386A/3/RC	72,50	1	003860013
386A/4/RC	103,50	1	003860014
386A/5/RC	137,00	1	003860015
386A/6/RC	240,50	1	003860016

388

pipe benders for thin walled copper,
light alloy and mild steel pipes

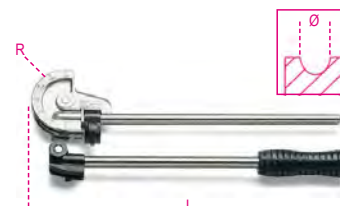

∅	L	R	€		
mm	mm	mm			
6	305	18,0	56,50	1	003880006
8	315	23,5	61,00	1	003880008
10	350	31,0	70,00	1	003880010
12	360	31,0	75,00	1	003880012
14	455	46,5	97,00	1	003880014
15	465	46,5	103,50	1	003880015
16	465	46,5	111,00	1	003880016

388A

pipe bending pliers for thin walled
copper and light alloy pipes



	∅	L	€		
	mm	mm			
388A/1	6-8-10	220	61,50	1	003880051
388A/2	1/4"-5/16"-3/8"	220	61,50	1	003880055



388C/C8

pipe bender with 7 forms
for thin walled copper and light alloy pipes



	∅ mm	€	1	003880200
388C/C8	10-12-14-16 18-20-22	448,00	1	003880200

400x330x110 mm - 3,6 kg

389/K4

kit of pipe bending springs for copper pipes
for external use



	∅ mm	L mm	€	1	003890001
389/K4	1/4-3/8-1/2-5/8	290	18,90	1	003890001

392C

adjustable drain tap pliers



	∅ mm	L mm	€	1	003920100
392C	25÷65	260	42,50	1	003920100

392RG/C

spare jaw protectors for item 392C, pair



	€	1	003920101
392RG/C	5,80	1	003920101

393

water tap wrench



	L mm	€	1	003930001
393	270	61,50	1	003930001

395

hinged water tap wrench

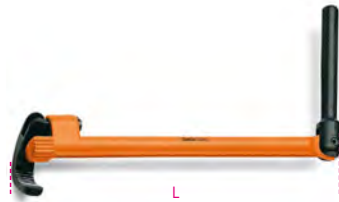

	∅ mm	L mm	€	1	003950001
395	15÷32	240	40,50	1	003950001

395T

telescopic hinged water tap wrench



	∅ mm	L mm	€	1	003950100
395T	10÷32	250÷430	54,50	1	003950100

399

pivoting clamp vices



	∅ mm	L min mm	€	1	003990005
399	10÷60	220	172,00	1	003990005
	1/8÷2"				
	10÷89	290	309,00	1	003990010
	1/8÷3"				

399R/...

spare kit for item 399
composed of two lower jaws and one upper jaw

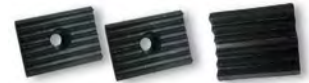

	€	1	003990105
399R/1/8-2"	20,50	1	003990105
399R/1/8-3"	33,00	1	003990110

Beta

Beta

CHART FOR METAL TWIST DRILLS

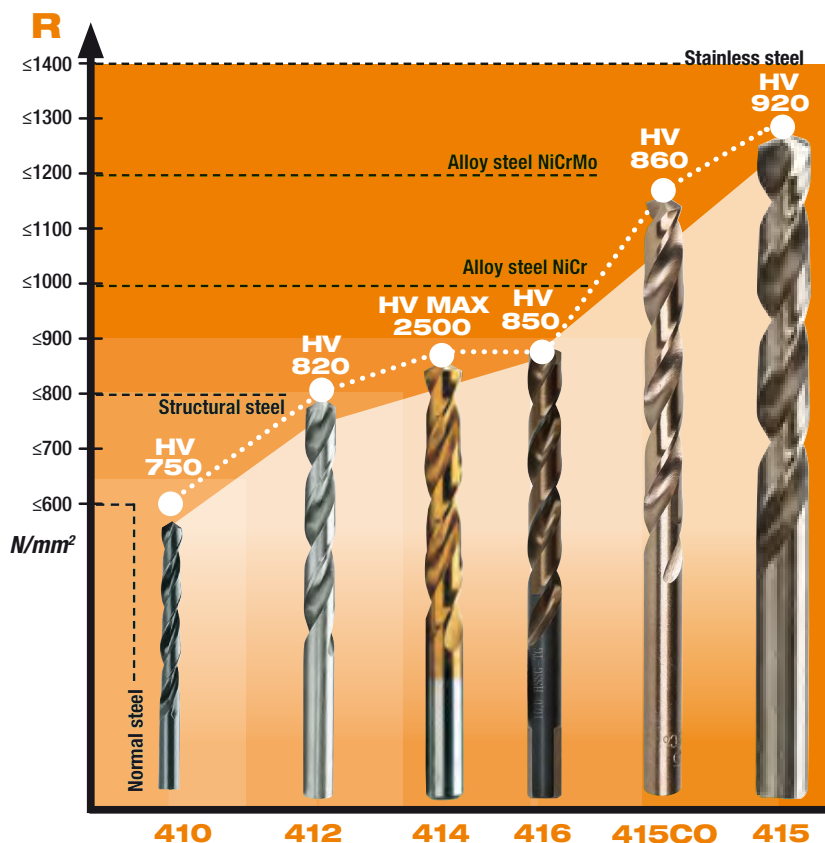

R N/mm² – Mechanical resistance of the material to drill.

HV – Twist drill hardness according to the Vickers scale: the higher the value, the higher the hardness of the material.

GUIDE TO TWIST DRILLS WITH CYLINDRICAL SHANKS

Rolled twist drills – Twist drills obtained from a hot-rolling manufacturing process. Good-quality twist drills, for use for light-duty jobs, e.g. drilling of iron, mild steel, light alloys and nonferrous metals in general.

Ground twist drills – Twist drills obtained entirely from grinding from a heat-treated steel bar. High-performance twist drills, for drilling steel and light alloys: constant efficiency, excellent chip removal and drilling precision.

HSS – High-speed steel, extremely hard, and resistant to high temperatures; the best material for cutting, tapping and threading tools.

Cobalt (Co) – A base alloy element, providing steel with improved heat resistance, and decreasing twist drill wear, e.g. at high temperatures. The higher the cobalt content, the better the performance of the tool. The most commonly used alloys have a 5% or 8% cobalt content.

HSS-Co – High-speed steel with a 5% or 8% cobalt content.

TiN – Ultrathin titanium nitride coating; based on its high hardness and low friction factor, it provides increased resistance to wear and oxidation and improved drilling chip removal.

Chrome steel – Tools made from chrome steel are suitable for manual use for threading of iron, light alloys, untreated steel and steel heat-treated at low hardness. They are widely used for cleaning and repairing damaged threads in all professional jobs in general, and in the automotive sector in particular.

Hard metal – Material with high wear resistance, used for plates in masonry drill bits.

118° sharpening – Standard sharpening angle of twist drills for metal, allowing quick drilling into metals, for easier centring and excellent heat dissipation.

130° sharpening – Wide sharpening angle, providing more precision in early drilling operations and requiring less drilling force.

Double 115°/135° sharpening – Combined benefits of the two angles, plus chip breaking function; the best choice for long chip materials.

SDS-Plus – Quick, safe tang for hammer drills.

410

twist drills with cylindrical shanks, short series HSS, rolled

R ≤ 650 N/mm²
HV ~ 750+820



DIN 338 ISO 235

Ø mm	L mm	L1 mm	€	Hand	Code
0,50	22	6	1,48	10	004100030
1,00	34	12	0,82	10	004100040
1,25	38	16	0,68	10	004100043
1,50	40	18	0,63	10	004100046
1,75	46	22	0,63	10	004100049
2,00	49	24	0,57	10	004100052
2,25	53	27	0,68	10	004100055
2,50	57	30	0,63	10	004100058
2,75	61	33	0,68	10	004100061
3,00	61	33	0,63	10	004100064
3,20	65	36	0,86	10	004100066
3,25	65	36	0,86	10	004100067
3,50	70	39	0,80	10	004100070
3,75	70	39	0,96	10	004100073
4,00	75	43	0,89	10	004100076
4,20	75	43	1,10	10	004100078
4,25	75	43	1,10	10	004100079
4,50	80	47	0,99	10	004100082
4,75	80	47	1,14	10	004100085
5,00	86	52	1,09	10	004100088
5,25	86	52	1,54	10	004100091
5,50	93	57	1,45	10	004100094
5,75	93	57	1,58	10	004100097
6,00	93	57	1,45	10	004100100
6,25	101	63	1,89	10	004100103
6,50	101	63	1,78	10	004100106
6,75	109	69	2,27	10	004100109
7,00	109	69	2,10	10	004100112
7,50	109	69	2,21	10	004100118
8,00	117	75	2,62	10	004100124
8,50	117	75	2,75	10	004100130
9,00	125	81	3,35	5	004100136
9,50	125	81	3,65	5	004100142
10,00	133	87	4,05	5	004100148
10,50	133	87	4,85	5	004100172
11,00	142	94	5,75	5	004100184
11,50	142	94	6,00	5	004100196
12,00	151	101	6,60	5	004100210
12,50	151	101	7,25	5	004100222
13,00	151	101	7,65	5	004100234
14,00	160	108	10,20	5	004100242
15,00	169	114	11,90	5	004100250
16,00	178	120	14,80	5	004100258
17,00	184	125	16,30	3	004100262
18,00	191	130	19,30	3	004100266
19,00	198	135	21,90	3	004100270
20,00	205	140	26,00	3	004100274



	€	Hand	Code
410/SP19 Ø 1÷10 x 0,5 mm	42,50	1	004100419
410/SPV1	23,30	1	004100420
410/SP25 Ø 1÷13 x 0,5 mm	89,00	1	004100425
410/SPV2	32,50	1	004100426



410/SEL19
Ø 1÷10 x 0,5 mm

€ 33,00 1 004100418

410MIX/SEL19

set of 13 twist drills, item 410,
and 6 twist drills with hard metal insets



410MIX/SEL19

€ 33,00 1 004100417

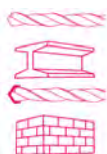

Ø 1 - 1,5 - 2 - 2,5 - 3 - 3,5 - 4
4,5 - 5 - 5,5 - 6 - 8 - 10 mm

Ø 4 - 5 - 6 - 8 - 9 - 10 mm

410A

twist drills with cylindrical shanks,
short series, HSS, rolled,
with small tang

R ≤ 650 N/mm²
HV ~ 750÷820



DIN 338 ISO 235

Ø mm	L mm	L1 mm	€	5	10
13,50	160	108	12,00	5	004100281
14,00	160	108	12,00	5	004100283
14,50	169	114	13,80	5	004100285
15,00	169	114	13,80	5	004100287
15,50	178	120	17,10	5	004100289
16,00	178	120	17,10	5	004100291
16,50	184	125	18,10	3	004100292
17,00	184	125	18,10	3	004100293
17,50	191	130	21,50	3	004100294
18,00	191	130	21,50	3	004100295
18,50	198	135	23,80	3	004100296
19,00	198	135	23,80	3	004100297
19,50	205	140	28,00	3	004100298
20,00	205	140	28,00	3	004100299

410AS

twist drills with cylindrical shanks,
short series, HSS,
rolled,
in inches

R ≤ 650 N/mm²
HV ~ 750÷820



ANSI B94

Ø "	L mm	L1 mm	€	5	10
1/16	48	22	0,57	10	004100371
5/64	51	25	0,63	10	004100372
3/32	57	32	0,71	10	004100373
7/64	67	38	0,80	10	004100374
1/8	70	41	0,88	10	004100375
9/64	73	44	0,94	10	004100376
5/32	79	51	1,01	10	004100377
11/64	83	54	1,14	10	004100378
3/16	89	59	1,31	10	004100379
13/64	92	62	1,36	10	004100380
7/32	95	64	1,48	10	004100381
15/64	98	67	1,73	10	004100382
1/4	102	70	1,95	10	004100383
17/64	105	73	2,29	10	004100384
9/32	108	75	2,52	10	004100385
19/64	111	78	2,80	10	004100386
5/16	114	81	3,55	10	004100387
21/64	117	84	3,65	10	004100388
11/32	121	87	4,30	5	004100389
23/64	124	89	4,40	5	004100390
3/8	127	92	4,55	5	004100391



410AS/SP21

€ 64,00 1 004100429

Ø 1/16-5/64-3/32-7/64
1/8-9/64-5/32-11/64-3/16
13/64-7/32-15/64-1/4
17/64-9/32-19/64-5/16
21/64-11/32-23/64-3/8

410AS/SPV1

€ 23,90 1 004100430



410AS/SEL21

€ 51,00 1 004100433

Ø 1/16-5/64-3/32-7/64
1/8-9/64-5/32-11/64-3/16
13/64-7/32-15/64-1/4
17/64-9/32-19/64-5/16
21/64-11/32-23/64-3/8

412

twist drills with cylindrical shanks,
short series HSS entirely ground glossy
finishing

R ≤ 800 N/mm²
HV ~ 750÷820



DIN 338 ISO 235

Ø mm	L mm	L1 mm	€	5	10
0,50	22	6	2,56	10	004120030
1,00	34	12	1,65	10	004120040
1,25	38	16	1,76	10	004120043
1,50	40	18	1,48	10	004120046
1,75	46	22	1,48	10	004120049
2,00	49	24	1,25	10	004120052
2,25	53	27	1,58	10	004120055
2,50	57	30	1,36	10	004120058
2,75	61	33	1,58	10	004120061
3,00	61	33	1,43	10	004120064
3,25	65	36	1,87	10	004120067
3,50	70	39	1,71	10	004120070
3,75	70	39	2,05	10	004120073
4,00	75	43	1,87	10	004120076
4,25	75	43	2,39	10	004120079
4,50	80	47	2,15	10	004120082
4,75	80	47	2,56	10	004120085
5,00	86	52	2,39	10	004120088
5,25	86	52	3,40	10	004120091
5,50	93	57	3,10	10	004120094
5,75	93	57	3,75	10	004120097
6,00	93	57	3,25	10	004120100
6,25	101	63	4,70	10	004120103
6,50	101	63	4,15	10	004120106
6,75	109	69	5,30	10	004120109
7,00	109	69	4,85	10	004120112
7,25	109	69	5,95	5	004120115
7,50	109	69	5,05	5	004120118
7,75	117	75	6,75	5	004120121
8,00	117	75	6,20	5	004120124
8,25	117	75	7,50	5	004120127
8,50	117	75	7,60	5	004120130
8,75	125	81	8,40	5	004120133
9,00	125	81	7,90	5	004120136
9,25	125	81	9,20	5	004120139
9,50	125	81	8,30	5	004120142
9,75	133	87	10,30	5	004120145
10,00	133	87	9,20	5	004120148
10,25	133	87	13,90	5	004120149
10,50	133	87	12,30	5	004120150
10,75	142	94	16,80	5	004120151
11,00	142	94	14,70	5	004120152
11,25	142	94	17,80	5	004120153
11,50	142	94	15,40	5	004120154
11,75	142	94	19,30	5	004120155
12,00	151	101	16,90	5	004120156
12,25	151	101	21,00	5	004120157
12,50	151	101	18,20	5	004120158
12,75	151	101	23,90	5	004120159
13,00	151	101	19,20	5	004120160



412/SP19

€ 84,50 1 004120419

Ø 1÷10 x 0,5 mm

412/SPV1

€ 23,30 1 004120420

412/SP25

€ 174,50 1 004120425

Ø 1÷13 x 0,5 mm

412/SPV2

€ 32,50 1 004120426

412/SP49

€ 418,00 1 004120449

Ø 1÷13 x 0,25 mm

412/SPV4

€ 99,50 1 004120451



412/C150



412/C150 € 510,00 1 004120450

412	Ø 3 mm	n.
	Ø 1 - 1,5 - 2 - 2,5 - 3 - 3,5 - 4 - 4,5 - 5 mm	20
	Ø 5,5 - 6 - 6,5 - 7 - 7,5 - 8 - 8,5 - 9 - 9,5 - 10 mm	10
		5

365x230x47 mm - 3,3 kg



412/SP91 € 543,00 1 004120452
Ø 1=10 x 0,10 mm

412A

twist drills with cylindrical shanks, short series, HSS, entirely ground, burnished, with small tang

R ≤ 800 N/mm²
HV ~ 750+820



DIN 338 ISO 235

Ø mm	L mm	L1 mm	€	n.
13,50	160	108	31,00	3
14,00	160	108	32,00	3
14,50	169	114	34,50	3
15,00	169	114	36,00	3
15,50	178	120	41,50	3
16,00	178	120	43,00	3
16,50	184	125	44,50	1
17,00	184	125	47,00	1
17,50	191	130	50,50	1
18,00	191	130	53,50	1
18,50	198	135	57,50	1
19,00	198	135	59,50	1
19,50	205	140	66,50	1
20,00	205	140	67,50	1

412C

twist drills with cylindrical shanks, extra-short series, HSS, entirely ground, burnished
R ≤ 800 N/mm²
HV ~ 750+820



DIN 1897 ISO 235

Ø mm	L mm	L1 mm	€	n.
3,00	46	16	1,43	10
3,25	49	18	1,58	10
3,50	52	20	1,58	10
4,00	55	22	1,76	10
4,50	58	24	2,00	10
5,00	62	26	2,05	10
5,50	66	28	2,72	10
6,00	66	28	3,05	10
6,5	70	31	3,60	10
7,00	74	34	4,30	10
7,5	74	34	4,55	5
8,00	79	37	5,60	5

412L

twist drills with cylindrical shanks, long series, HSS entirely ground burnished
R ≤ 800 N/mm²
HV ~ 750+820



DIN 340

Ø mm	L mm	L1 mm	€	n.
2,00	85	56	3,40	10
2,50	95	62	3,60	10
3,00	100	66	3,75	10
3,50	112	73	4,35	10
4,00	119	78	4,70	10
4,50	126	82	5,70	10
5,00	132	87	5,95	10
5,50	139	91	7,50	10
6,00	139	91	8,05	10
6,50	148	97	9,65	5
7,00	156	102	11,20	5
8,00	165	109	14,90	5
9,00	175	115	17,60	5
10,00	184	121	19,30	5

412XL

twist drills with cylindrical shanks, extra-long series, HSS, entirely ground

R ≤ 800 N/mm²
HV ~ 750+820



DIN 1869/1

Ø mm	L mm	L1 mm	€	n.
3,00	150	100	13,00	1
3,50	165	115	14,30	1
4,00	175	120	14,30	1
4,50	185	125	14,80	1
5,00	195	135	14,80	1
5,50	205	140	18,20	1
6,00	205	140	18,20	1

Ø mm	L mm	L1 mm	€	n.
6,50	215	150	21,50	1
7,00	225	155	24,90	1
7,50	225	155	28,50	1
8,00	240	165	30,50	1
8,50	240	165	32,00	1
9,00	250	175	41,00	1
9,50	250	175	44,50	1
10,00	265	185	44,50	1
10,50	265	185	44,50	1
11,00	280	195	44,50	1
12,00	295	205	56,00	1
13,00	295	205	58,50	1

414

twist drills with cylindrical shanks, short series, HSS-TiN entirely ground

R ≤ 900 N/mm²
HV 0,05 ~ 2500



DIN 338 ISO 235

Ø mm	L mm	L1 mm	€	n.
1,00	34	12	2,24	10
1,25	38	16	2,56	10
1,50	40	18	2,00	10
1,75	46	22	2,56	10
2,00	49	24	2,10	10
2,25	53	27	2,62	10
2,50	57	30	2,21	10
2,75	61	33	3,00	10
3,00	61	33	2,49	10
3,25	65	36	3,20	10
3,50	70	39	3,00	10
3,75	70	39	3,35	10
4,00	75	43	3,00	10
4,25	75	43	3,65	10
4,50	80	47	3,35	10
4,75	80	47	4,20	10
5,00	86	52	3,90	10
5,25	86	52	5,45	10
5,50	93	57	4,65	10
5,75	93	57	5,70	10
6,00	93	57	5,25	10
6,25	101	63	6,60	10
6,50	101	63	5,80	10
6,75	109	69	7,90	10
7,00	109	69	6,40	10
7,25	109	69	8,75	5
7,50	109	69	7,80	5
7,75	117	75	10,30	5
8,00	117	75	9,15	5
8,25	117	75	10,70	5
8,50	117	75	9,50	5
8,75	125	81	13,30	5
9,00	125	81	11,90	5
9,25	125	81	15,10	5
9,50	125	81	13,30	5
9,75	133	87	15,80	5
10,00	133	87	14,00	5
10,50	133	87	16,50	5
11,00	142	94	17,80	5
11,50	142	94	19,30	5
12,00	151	101	20,70	5
12,50	151	101	23,80	5
13,00	151	101	24,80	5





	€	🔧	📦
414/SP19 Ø 1÷10 x 0,5 mm	123,50	1	004140419
414/SPV1	23,90	1	004140420
414/SP25 Ø 1÷13 x 0,5 mm	249,50	1	004140425
414/SPV2	32,50	1	004140426
414/SP49 Ø 1÷13 x 0,25 mm	549,00	1	004140429
414/SPV4	99,50	1	004140430

414/C116



	€	🔧	📦
414/C116	502,00	1	004140450

414	Ø 1 - 1,5 - 2 - 2,5 - 3 - 3,5 - 4 - 4,5 - 5 mm	n.
	Ø 5,5 - 6 - 6,5 - 7 - 7,5 - 8 mm	3
	Ø 8,5 - 9 - 9,5 - 10 mm	2

365x230x47 mm - 2,7 Kg

415

twist drills with cylindrical shanks,
short series, HSS-CO 8%
entirely ground

R ≤ 1400 N/mm²
HV ~ 850-920



DIN 338 ISO 235

Ø mm	L mm	L1 mm	€	🔧	📦
0,50	22	6	6,30	10	004150029
1,00	34	12	3,10	10	004150040
1,25	38	16	3,45	10	004150043
1,50	40	18	3,10	10	004150046
1,75	46	22	3,25	10	004150049
2,00	49	24	3,00	10	004150052
2,25	53	27	3,65	10	004150055
2,50	57	30	3,35	10	004150058
2,75	61	33	3,65	10	004150061
3,00	61	33	3,40	10	004150064
3,25	65	36	4,65	10	004150067
3,50	70	39	4,30	10	004150070
3,75	70	39	5,25	10	004150073
4,00	75	43	4,65	10	004150076
4,25	75	43	5,85	10	004150079
4,50	80	47	5,30	10	004150082
4,75	80	47	6,10	10	004150085
5,00	86	52	5,70	10	004150088

Ø mm	L mm	L1 mm	€	🔧	📦
5,25	86	52	8,30	10	004150091
5,50	93	57	7,50	10	004150094
5,75	93	57	8,65	10	004150097
6,00	93	57	7,90	10	004150100
6,25	101	63	11,20	10	004150103
6,50	101	63	9,85	10	004150106
6,75	109	69	12,90	10	004150109
7,00	109	69	11,60	10	004150112
7,25	109	69	13,90	5	004150115
7,50	109	69	12,60	5	004150118
7,75	117	75	16,40	5	004150121
8,00	117	75	14,80	5	004150124
8,25	117	75	17,80	5	004150127
8,50	117	75	16,80	5	004150130
8,75	125	81	22,10	5	004150133
9,00	125	81	19,50	5	004150136
9,25	125	81	22,90	5	004150139
9,50	125	81	21,10	5	004150142
9,75	133	87	25,00	5	004150145
10,00	133	87	23,10	5	004150148
10,25	133	87	29,50	5	004150149
10,50	133	87	25,50	5	004150150
10,75	142	94	33,00	5	004150151
11,00	142	94	29,50	5	004150152
11,25	142	94	36,50	5	004150153
11,50	142	94	32,50	5	004150154
11,75	142	94	37,50	5	004150155
12,00	151	101	35,50	5	004150156
12,25	151	101	45,00	5	004150157
12,50	151	101	37,50	5	004150158
12,75	151	101	49,50	5	004150159
13,00	151	101	40,50	5	004150160
14,00	160	108	71,00	3	004150164
15,00	169	114	84,50	3	004150168
16,00	178	120	103,50	3	004150172
17,00	186	125	117,00	1	004150174
18,00	194	130	130,50	1	004150176
19,00	202	135	150,00	1	004150178
20,00	210	140	168,50	1	004150180



Co8%

	€	🔧	📦
415/SP19 Ø 1÷10 x 0,5 mm	173,50	1	004150419
415/SPV1	23,30	1	004150420
415/SP25 Ø 1÷13 x 0,5 mm	359,00	1	004150425
415/SPV2	32,50	1	004150426
415/SP49 Ø 1÷13 x 0,25 mm	891,00	1	004150431
415/SPV4	99,50	1	004150432

415/C116



	€	🔧	📦
415/C116	758,00	1	004150450

415	Ø 1 - 1,5 - 2 - 2,5 - 3 - 3,5 - 4 - 4,5 - 5 mm	n.
	Ø 5,5 - 6 - 6,5 - 7 - 7,5 - 8 mm	3
	Ø 8,5 - 9 - 9,5 - 10 mm	2

365x230x47 mm - 2,7 kg



	€	🔧	📦
415/SP91 Ø 1÷10 x 0,10 mm	1.039,00	1	004150460

415CO

twist drills with cylindrical shanks,
short series, HSS-CO 5%,
entirely ground

R ≤ 1200 N/mm²
HV ~ 800-860



DIN 338 ISO 235

Ø mm	L mm	L1 mm	€	🔧	📦
1,00	34	12	1,58	10	004150310
1,50	40	18	1,58	10	004150312
2,00	49	24	1,58	10	004150314
2,50	57	30	1,65	10	004150316
3,00	61	33	1,65	10	004150320
3,50	70	39	2,05	10	004150322
4,00	75	43	2,39	10	004150324
4,50	80	47	2,72	10	004150326
5,00	86	52	2,84	10	004150328
5,50	93	57	3,60	10	004150330
6,00	93	57	4,00	10	004150332
6,50	101	63	4,75	10	004150334
7,00	109	69	5,90	10	004150336
7,50	109	69	6,45	5	004150338
8,00	117	75	7,60	5	004150340
8,50	117	75	7,90	5	004150342
9,00	125	81	9,75	5	004150344
9,50	125	81	10,30	5	004150346
10,00	133	87	11,90	5	004150348
10,50	133	87	14,30	5	004150350
11,00	142	94	15,80	5	004150352
11,50	142	94	17,40	5	004150354
12,00	151	101	19,00	5	004150356
12,50	151	101	20,80	5	004150358
13,00	151	101	22,60	5	004150360

415CO-A

twist drills with cylindrical shanks,
short series, HSS-CO 5%,
entirely ground

R ≤ 1200 N/mm²
HV ~ 800-860



DIN 338

Ø mm	L mm	L1 mm	€	🔧	📦
14,00	160	108	44,50	3	004150364
15,00	169	114	51,00	3	004150366
16,00	178	120	61,50	3	004150368
17,00	184	125	63,00	1	004150370
18,00	191	130	80,50	1	004150372
19,00	198	135	93,00	1	004150374
20,00	205	140	107,50	1	004150376



Co5%

DIN 338

415CO/SP19	€ 91,00	1	004150421
Ø 1÷10 x 0,5 mm			
415/SPV1	€ 23,30	1	004150420

415C

twist drills with cylindrical shanks, extra-short series, HSS-CO 5%, entirely ground
R ≤ 1200 N/mm²
HV ~ 800÷860



Co5%

DIN 1897 ISO 235

Ø mm	L mm	L1 mm	€		
3,00	46	16	2,21	10	004150288
3,25	49	18	2,84	10	004150289
3,50	52	20	2,84	10	004150290
4,00	55	22	3,10	10	004150292
4,50	58	24	3,55	10	004150294
5,00	62	26	3,80	10	004150296
5,50	66	28	5,05	10	004150298
6,00	66	28	5,40	10	004150300
6,50	70	31	5,60	10	004150301
7,00	74	34	6,70	10	004150302
7,50	74	34	7,70	5	004150303
8,00	79	37	9,50	5	004150304

415L

twist drills with cylindrical shanks, long series, HSS-CO 5%, entirely ground

R ≤ 1200 N/mm²
HV ~ 800÷860



Co5%

DIN 340

Ø mm	L mm	L1 mm	€		
3,00	100	66	4,35	10	004150236
3,50	112	73	4,75	10	004150238
4,00	119	78	5,90	10	004150240
4,50	126	82	7,20	10	004150242
5,00	132	87	7,50	10	004150244
5,50	139	91	9,40	10	004150246
6,00	139	91	10,30	10	004150248
6,50	148	97	12,10	5	004150250
7,00	156	102	14,30	5	004150252
8,00	165	109	18,20	5	004150256
9,00	175	115	22,70	5	004150260
10,00	184	121	29,00	5	004150264

416

drill with cylindrical shank, specially ground, with two cutter pairs

R ≤ 900 N/mm²
HV || 820÷850

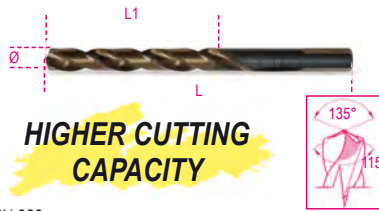

HIGHER CUTTING CAPACITY

DIN 338

Ø mm	L mm	L1 mm	€		
1,00	34	12	2,44	10	004160010
1,50	40	18	2,44	10	004160015
2,00	49	24	2,44	10	004160020
2,50	57	30	2,56	10	004160025
3,00	61	33	2,72	10	004160030
3,50	70	39	3,05	10	004160035
4,00	75	43	3,40	10	004160040
4,50	80	47	3,75	10	004160045
5,00	86	52	4,30	10	004160050
5,50	93	57	5,50	10	004160055
6,00	93	57	5,90	10	004160060
6,50	101	63	6,95	10	004160065
7,00	109	69	8,05	10	004160070
7,50	109	69	8,65	5	004160075
8,00	117	75	10,40	5	004160080
8,50	117	75	11,20	5	004160085
9,00	125	81	13,10	5	004160090
9,50	125	81	14,00	5	004160095
10,00	133	87	16,20	5	004160100

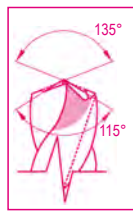

416/SP19	€ 122,50	1	004160419
Ø 1÷10 x 0,5 mm			

417

helical cylindrical masonry drill bits, short series, made from milled steel with hard metal plates



DIN 8039

Ø mm	L mm	€		
3	70	3,25	10	004170003
4	75	3,25	10	004170004
5	85	3,45	10	004170005
5L	150	7,70	5	004170105
6	100	3,55	10	004170007
6L	150	7,70	5	004170106
7	120	4,00	10	004170009
8	120	4,45	10	004170010
8L	200	8,40	5	004170113
9	120	5,00	10	004170011
10	120	5,85	10	004170012
10L	200	10,10	5	004170120
12	150	7,60	10	004170014
12L	200	10,90	5	004170125
14	150	10,60	5	004170016
16	150	13,10	5	004170018



417/SP8	€ 49,50	1	004170100
Ø 3-4-5-6-8-9-10-12 mm			

419

hammer drill bits with milled shanks and hard metal plates
HVA- 1650



DIN 8039

Ø mm	L mm	€		
4	110	6,70	10	004190002
5	110	6,70	10	004190004
5	160	7,40	10	004190006
6	110	6,55	10	004190012
6	160	7,20	10	004190014
6	210	9,65	10	004190016
7	160	7,90	10	004190028
8	110	7,05	10	004190030
8	160	7,60	10	004190032
8	210	9,20	10	004190034
8	260	12,50	10	004190036
8	310	15,30	10	004190038
8	460	28,00	10	004190042
9	160	9,40	5	004190044
10	160	9,65	5	004190050
10	210	11,10	5	004190052
10	260	13,80	5	004190054
10	310	19,50	5	004190056
10	460	30,50	5	004190060
12	160	10,70	5	004190064
12	210	14,50	5	004190066
12	260	15,50	5	004190068
12	460	32,00	5	004190074
14	160	14,80	3	004190086
14	260	17,80	3	004190090
14	310	25,50	3	004190092
14	460	33,00	3	004190096
16	210	21,80	3	004190112
16	250	23,00	3	004190114
16	300	28,00	3	004190116
16	450	36,50	3	004190120
18	250	29,50	1	004190124
20	310	29,50	1	004190128



419T

hammer drill bits
with milled shanks, 4 spirals and 4 cutters

HVA~ 1650

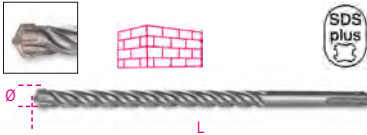

Ø mm	L mm	€	🔧	📄
5	110	4,50	5	004190604
5	160	5,10	5	004190606
6	110	4,75	5	004190612
6	160	5,60	5	004190614
6	210	7,60	5	004190616
7	160	5,70	5	004190628
8	110	5,25	5	004190630
8	160	5,90	5	004190632
8	210	7,80	5	004190634
8	260	8,95	5	004190636
8	310	10,90	5	004190638
9	160	6,25	3	004190644
10	160	6,30	3	004190650
10	210	8,40	3	004190652
10	260	9,10	3	004190654
10	310	13,00	3	004190656
10	460	17,60	3	004190660
12	160	7,00	3	004190664
12	210	9,20	3	004190666
12	260	9,75	3	004190668
12	460	18,20	3	004190674
14	160	9,50	2	004190686
14	260	11,10	2	004190690
14	310	15,70	2	004190692
14	460	17,60	2	004190696
16	210	12,70	2	004190712
16	260	16,80	2	004190714
16	310	18,10	2	004190716
16	460	18,70	2	004190720
18	260	20,50	1	004190724
20	310	24,90	1	004190728

420A

subland twist drills with independent spirals,
for screw holes, 90°,
HSS,
for through holes

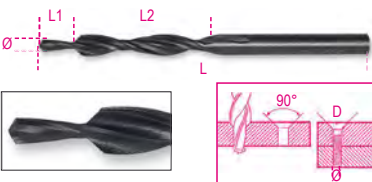

DIN 8374

M	Ø mm	D mm	L1 mm	L2 mm	L mm	€	🔧	📄
3	3,2	6	9,00	57,00	93,00	47,50	1	004200003
4	4,3	8	11,00	75,00	117,00	55,50	1	004200004
5	5,3	10	13,00	87,00	133,00	69,00	1	004200005
6	6,4	11,5	15,00	94,00	142,00	79,50	1	004200006
8	8,4	15	19,00	114,00	169,00	135,00	1	004200008
10	10,5	19	23,00	135,00	198,00	209,00	1	004200010

420B

subland twist drills with independent spirals for
screw holes, 180°,
HSS,
for through holes

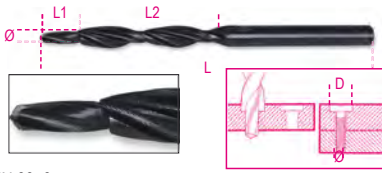

DIN 8376

M	Ø mm	D mm	L1 mm	L2 mm	L mm	€	🔧	📄
3	3,4	6	9,00	57,00	93,00	42,00	1	004200053
4	4,5	8	11,00	75,00	117,00	47,00	1	004200054
5	5,5	10	13,00	87,00	133,00	58,00	1	004200055
6	6,6	11	15,00	94,00	142,00	67,50	1	004200056
8	9	15	19,00	114,00	169,00	85,00	1	004200058
10	11	18	23,00	130,00	191,00	126,50	1	004200060

421

countersinks with guide pins,
fine grade,
made of HSS

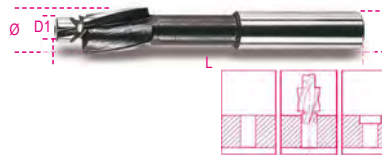

DIN 373

M	L mm	Ø mm	D1 mm	D mm	€	🔧	📄
3	71	6	3,2	5	24,50	1	004210003
4	71	8	4,3	5	24,50	1	004210004
5	80	10	5,3	8	24,50	1	004210005
6	80	11	6,4	8	24,90	1	004210006
8	100	15	8,4	12,5	40,50	1	004210008
10	100	18	10,5	12,5	48,00	1	004210010
12	100	20	13,0	12,5	52,50	1	004210012



	€	🔧	📄
421/SP6	198,50	1	004210019
M 3-4-5-6-8-10			
421/SPV	14,80	1	004210020

422

ground centre drill bits,
60° countersink angle,
made of HSS

• For quick, safe centre holes



DIN 333/A

Ø mm	D mm	L mm	€	🔧	📄
1,60	4,0	35,5	7,70	1	004220116
2,50	6,3	45,0	8,85	1	004220125
3,15	8,0	50,0	10,00	1	004220131

423

special end mills for welding
HSS ground



Ø mm	L mm	€	🔧	📄
6	66	15,30	5	004230006
7	74	18,70	5	004230007
8	79	20,50	5	004230008
10	89	23,90	5	004230010

423A

special mills for spot welding,
HSS ground



DIN 1412/E

Ø mm	L mm	€	🔧	📄
6,5	40	22,20	1	004230015
8,0	40	24,20	1	004230020

424

conical drill bits, HSS

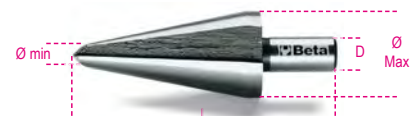

	L mm	Ø mm	D mm	€	🔧	📄
424/1	58	3÷14	6	28,00	2	004240001
424/2	63	6÷20	8	46,50	2	004240002
424/3	60	16÷30	10	80,50	2	004240003
424/4	80	3÷22	8	98,50	1	004240004
424/5	102	3÷31	10	133,00	1	004240005
424/6	86	26÷40	13	168,50	1	004240006
424/7	89	36÷50	13	252,00	1	004240007
424/8	90	40÷61	13	418,00	1	004240008



	€	🔧	📄
424/SP3	161,00	1	004240019
424/1+424/2+424/3			
Ø 3÷30 mm			
424/SPV	22,20	1	004240020

425

stepped drills, HSS

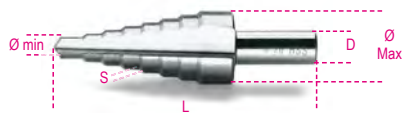

	L	Ø	S	D	€		
	mm	mm	mm	mm			
425/1	70	4÷12	1	6	47,00	2	004250010
425/2	55	4÷12	2	6	50,00	2	004250012
425/3	85	4÷20	2	10	73,00	2	004250015
425/4	85	12÷20	1	10	111,00	1	004250016
425/5	97	20÷30	1	10	218,00	1	004250017
425/6	75	4÷30	2	10	152,00	1	004250020
425/7	97	30÷40	1	13	303,00	1	004250025
425/8	100	40÷50	1	13	422,00	1	004250029



425/SP3	277,00	1	004250030
425/1+425/3+425/6			
Ø 4÷30 mm			
425/SPV	22,20	1	004250035

426

countersinking cutters with three cutters, HSS



DIN 335-C

GR	Ø	L	Ø1	€		
	mm	mm	mm			
1	4,3	44	4	15,80	3	004260001
2	5,3	44	4	15,80	3	004260002
3	6,3	44	5	16,50	3	004260003
4	7,3	44	6	19,30	3	004260004
5	8,3	50	6	19,30	3	004260005
6	9,4	50	6	21,50	3	004260006
7	10,4	54	6	24,40	3	004260007
8	12,4	54	8	26,00	3	004260008
9	15,0	56	10	29,00	3	004260009
10	16,5	60	10	31,00	3	004260010
11	20,5	63	10	43,00	3	004260011
12	25,0	66	10	67,50	3	004260012
13	28,0	71	12	91,00	3	004260013
14	31,0	71	12	96,00	3	004260014



DIN 335-C

426/SP6	169,00	1	004260030
GR 3-5-7-8-10-11			
Ø 6,3÷20,5 mm			
426/SPV	22,20	1	004260035

426T

countersinking cutters with three cutters, HSS + TiN

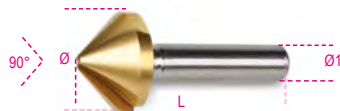

DIN 335-C

GR	Ø	L	Ø1	€		
	mm	mm	mm			
1	4,3	44	4	20,50	3	004260061
2	5,3	44	4	20,50	3	004260062
3	6,3	44	5	21,00	3	004260063
4	7,3	44	6	23,90	3	004260064
5	8,3	50	6	23,90	3	004260065
6	9,4	50	6	25,50	3	004260066
7	10,4	54	6	29,00	3	004260067
8	12,4	54	8	30,50	3	004260068
9	15,0	56	10	34,50	3	004260069
10	16,5	60	10	38,50	3	004260070
11	20,5	63	10	50,00	3	004260071
12	25,0	66	10	76,00	3	004260072
13	28,0	71	12	95,00	3	004260073
14	31,0	71	12	101,50	3	004260074



DIN 335-C

426T/SP6	193,00	1	004260080
GR 3-5-7-8-10-11			
Ø 6,3÷20,5 mm			
426/SPV	22,20	1	004260035

426SB

countersinking cutters, HSS



GR	Ø	D	L	€		
	mm	mm	mm			
426/SB1	1	2÷5	6 45	21,30	1	004260101
426/SB2	2	5÷10	8 48	26,50	1	004260102
426/SB3	3	10÷15	10 65	47,00	1	004260103
426/SB4	4	15÷20	12 85	91,50	1	004260104
426/SB5	5	20÷25	15 102	153,50	1	004260105
426/SB6	6	25÷30	15 115	260,00	1	004260106



Beta



426SB/SP4	212,00	1	004260130
426/SB1-426/SB2			
426/SB3-426/SB4			
Ø 2÷20 mm			
426SB/SPV1	22,20	1	004260135

426MD-3/CP3

mini rotary cutters made from hard metal

- Smooth cross cut with chip breaker



L	Ø	€		
mm	mm			
38,1	3	11,70	1	004260332

426MD-3/CT3

mini rotary cutters made from hard metal

- Smooth cross cut with chip breaker



L	Ø	€		
mm	mm			
37,8	3	11,70	1	004260333

426MD-3/F3

mini rotary cutters made from hard metal

- Smooth cross cut with chip breaker



L	Ø	€		
mm	mm			
38,3	3	11,70	1	004260334

426MD-3/FA3

mini rotary cutters made from hard metal

- Smooth cross cut with chip breaker



L	Ø	€		
mm	mm			
38,2	3	11,70	1	004260339

426MD-3/OG3

mini rotary cutters made from hard metal

- Smooth cross cut with chip breaker



L	Ø	€		
mm	mm			
38,1	3	11,70	1	004260337

426MD-3/OV3

mini rotary cutters made from hard metal

• Smooth cross cut with chip breaker



L mm	Ø mm	€	1	004260331
38,2	3	11,70		

426MD-3/S3

mini rotary cutters made from hard metal

• Smooth cross cut with chip breaker



L mm	Ø mm	€	1	004260338
38,0	3	11,70		

426MD-3/T3

mini rotary cutters made from hard metal

• Smooth cross cut with chip breaker



L mm	Ø mm	€	1	004260336
38,3	3	11,70		

426MD-3/TA3

mini rotary cutters made from hard metal

• Smooth cross cut with chip breaker



L mm	Ø mm	€	1	004260335
38,3	3	11,70		



426MD-3/A9		€	1	004260349
426MD-3/OV3 - 426MD-3/CP3		105,50		
426MD-3/CT3 - 426MD-3/F3				
426MD-3/TA3 - 426MD-3/T3				
426MD-3/OG3 - 426MD-3/S3				
426MD-3/FA3				

426MD/CP

rotary files, made from hard metal

cross cut HM6



L mm	Ø mm	€	1	004260532
50	6	32,50		
63	8	36,00		
63	9,5	40,50		
69	12	57,00		
69	16	81,50		

426MD/CT

rotary files, made from hard metal

cross cut HM6



L mm	Ø mm	€	1	004260533
50	6	32,50		
63	8	36,00		
63	9,5	40,50		
69	12	57,00		
69	16	79,00		

426MD/F

rotary files, made from hard metal

cross cut HM6



L mm	Ø mm	€	1	004260534
50	6	32,50		
63	8	36,00		
63	9,5	40,50		
69	12	57,00		
69	16	64,50		

426MD/FA

rotary files, made from hard metal

cross cut HM6



L mm	Ø mm	€	1	004260539
50	6	32,50		
63	8	36,00		
63	9,5	40,50		
69	12	57,00		
69	16	73,50		

426MD/OG

rotary files, made from hard metal

cross cut HM6



L mm	Ø mm	€	1	004260537
50	6	32,50		
63	8	36,00		
70	10	40,50		
76	12	57,00		
81	16	81,50		

426MD/OV

rotary files, made from hard metal

cross cut HM6



L mm	Ø mm	€	1	004260531
50	6	32,50		
61	9,5	40,50		
67	12	57,00		
69	16	73,50		

426MD/S

rotary files, made from hard metal

cross cut HM6



L mm	Ø mm	€	1	004260538
50	6	32,50		
51	8	36,00		
53	9,5	40,50		
56	12	57,00		
59	16	64,50		

426MD/T

rotary files, made from hard metal

cross cut HM6



L mm	Ø mm	€	1	004260536
50	6	32,50		
63	8	36,00		
63	9,5	40,50		
69	12	57,00		
70	16	64,50		

426MD/TA

rotary files, made from hard metal

cross cut HM6



L mm	Ø mm	€	1	004260535
50	6	32,50		
67	8	36,00		
72	9,5	40,50		
73	12	57,00		
78	16	81,50		



426MD/SP10		€	1	004260510
426MD/CP-426MD/CT-426MD/F		420,00		
426MD/T-426MD/S				
Ø 8-12 mm				

427

morse taper extractors



DIN 317

GR	L mm	A mm	€	📦	📄
0	92	13	11,30	3	004270000
1-2	140	19	16,00	3	004270002
3	190	25	19,20	3	004270003
4	225	30	32,50	3	004270004
5-6	260	35	59,50	3	004270006

428FP

machine taps for clearance holes,
coarse pitch threads, HSS



ISO 529

M	■ mm	L mm	L1 mm	€	📦	📄
3x0,5	2,7	56	11	15,60	10	004280003
4x0,7	3,4	63	13	15,60	10	004280004
5x0,8	4,9	70	16	15,60	10	004280005
6x1	4,9	80	19	16,50	10	004280006
8x1,25	6,2	90	22	20,00	10	004280008
10x1,5	8,0	100	24	23,30	10	004280010
12x1,75	7,0	110	29	30,50	5	004280012
14x2	9,0	110	30	37,00	5	004280014
16x2	9,0	110	30	45,00	5	004280016
18x2,5	11,0	125	34	58,00	3	004280018
20x2,5	12,0	140	34	65,50	3	004280020
22x2,5	14,5	140	34	78,00	3	004280022
24x3	14,5	160	38	85,00	3	004280024

428FC

machine taps for blind holes,
coarse pitch threads, HSS



ISO 529

M	■ mm	L mm	L1 mm	€	📦	📄
3x0,5	2,7	56	11	18,90	10	004280103
4x0,7	3,4	63	13	18,90	10	004280104
5x0,8	4,9	70	16	18,90	10	004280105
6x1	4,9	80	19	19,50	10	004280106
8x1,25	6,2	90	22	21,20	10	004280108
10x1,5	8,0	100	24	25,00	10	004280110
12x1,75	7,0	110	29	32,00	5	004280112
14x2	9,0	110	30	43,00	5	004280114
16x2	9,0	110	30	50,50	5	004280116
18x2,5	11,0	125	34	67,50	3	004280118
20x2,5	12,0	140	34	72,50	3	004280120
22x2,5	14,5	140	34	88,00	3	004280122
24x3	14,5	160	38	93,50	3	004280124

428/C14

assortment of 14 machine taps
items 428FP + 428FC



428/C14	€	📦	📄
428FP M3÷12	341,00	1	004280201
428FC M3÷12			
428/SPV	20,00	1	004280202

429FP

machine taps for clearance holes,
coarse pitch threads HSS-CO 5%



ISO 529

M	■ mm	L mm	L1 mm	€	📦	📄
3x0,5	2,7	56	11	20,50	5	004290003
4x0,7	3,4	63	13	20,50	5	004290004
5x0,8	4,9	70	16	20,50	5	004290005
6x1	4,9	80	19	22,20	5	004290006
8x1,25	6,2	90	22	24,40	5	004290008
10x1,5	8,0	100	24	28,50	5	004290010
12x1,75	7,0	110	29	36,00	5	004290012
14x2	9,0	110	30	48,00	5	004290014

429FC

machine taps for blind holes,
coarse pitch threads HSS-CO 5%



ISO 529

M	■ mm	L mm	L1 mm	€	📦	📄
3x0,5	2,7	56	11	24,90	5	004290103
4x0,7	3,4	63	13	24,90	5	004290104
5x0,8	4,9	70	16	24,90	5	004290105
6x1	4,9	80	19	26,00	5	004290106
8x1,25	6,2	90	22	29,00	5	004290108
10x1,5	8,0	100	24	35,50	5	004290110
12x1,75	7,0	110	29	43,00	5	004290112
14x2	9,0	110	30	56,00	5	004290114

429/C14

assortment of 14 machine taps
items 429FP + 429FC



429/C14	€	📦	📄
429FP M3÷12	418,00	1	004290201
429FC M3÷12			
429/SPV	20,00	1	004280202

430

hand taps, coarse pitch, metric thread
made from chrome-steel

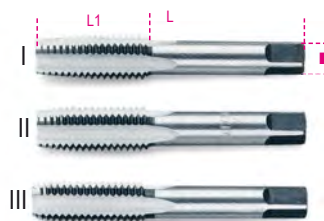

DIN 352 UNI 4535

M	■ mm	L mm	L1 mm	€	📦	📄
2x0,4	2,5	36	11	13,60	5	004300002
3x0,5	2,5	40	12	9,65	5	004300003
4x0,7	3,0	45	14	9,65	5	004300004
5x0,8	4,0	48	16	10,00	5	004300005
6x1	5,0	50	18	10,10	5	004300006
7x1	4,5	50	18	12,90	5	004300007
8x1,25	5,0	56	22	13,00	3	004300008
9x1,25	5,5	63	22	17,60	3	004300009
10x1,5	6,0	70	25	16,80	3	004300010
11x1,5	7,0	70	25	21,50	3	004300011
12x1,75	7,0	75	30	21,50	3	004300012
14x2	8,0	80	32	27,00	3	004300014
16x2	10,0	80	32	32,00	3	004300016
18x2,5	11,0	95	40	43,00	1	004300018
20x2,5	12,0	95	40	51,50	1	004300020
22x2,5	14,5	100	40	62,50	1	004300022
24x3	14,5	110	50	74,00	1	004300024



430/SP21	€	📦	📄
M 3-4-5-6-8-10-12	115,50	1	004300201
430/SPV	23,90	1	004300202

430ASW

hand taps, Whitworth thread
made from chrome-steel



DIN 352

BSW	mm	L	L1	€	W	U
1/8x40	2,7	40	12	9,45	5	004300031
5/32x32	3,4	45	14	9,45	5	004300032
3/16x24	4,3	48	18	9,45	5	004300033
1/4x20	4,9	50	22	11,00	5	004300034
5/16x18	4,9	56	25	13,40	3	004300035
3/8x16	5,5	70	28	17,60	3	004300036
7/16x14	6,2	70	30	20,00	3	004300037
1/2x12	7,0	75	32	22,30	3	004300038
9/16x12	9,0	80	32	27,00	1	004300039
5/8x11	9,0	80	38	32,50	1	004300040
3/4x10	11,0	95	40	47,00	1	004300041
7/8x9	14,5	100	40	59,50	1	004300042
1"x8	16,0	110	50	76,50	1	004300043

430ASC

hand taps, UNC thread
made from chrome-steel



ANSI B.1

UNC	mm	L	L1	€	W	U
1/4x20	4,9	70	30	14,00	5	004300051
5/16x18	4,9	70	30	18,20	5	004300052
3/8x16	5,5	75	35	20,50	3	004300053
7/16x14	6,2	80	40	26,50	3	004300054
1/2x13	7,0	85	45	33,50	3	004300055
9/16x12	9,0	90	45	41,00	3	004300056
5/8x11	9,0	100	47	47,00	3	004300057
3/4x10	11,0	110	50	64,00	3	004300058
7/8x9	14,5	120	60	73,50	1	004300059
1"x8	16,0	130	60	83,00	1	004300060

431

hand taps, coarse pitch,
metric thread HSS



DIN 352 UNI 4535

M	mm	L	L1	€	W	U
3x0,5	2,5	40	12	18,20	5	004310003
4x0,7	3,0	45	14	18,20	5	004310004
5x0,8	4,0	48	16	18,70	5	004310005
6x1	5,0	50	18	18,70	5	004310006

M	mm	L	L1	€	W	U
7x1	5,0	50	18	25,00	5	004310007
8x1,25	5,0	56	22	22,70	3	004310008
10x1,5	6,0	70	25	28,00	3	004310010
12x1,75	7,0	75	30	42,50	3	004310012
14x2	9,0	80	32	59,50	1	004310014
16x2	9,0	80	32	67,00	1	004310016
18x2,5	11,0	95	40	100,50	1	004310018
20x2,5	12,0	95	40	107,50	1	004310020
22x2,5	12,0	100	40	154,00	1	004310022
24x3	14,5	110	50	173,50	1	004310024



	€	W	U
431/SP21	210,00	1	004310201
M 3-4-5-6-8-10-12			
431/SPV	23,90	1	004310202

433

hand taps, fine pitch, metric thread
made from chrome-steel



DIN 2181 UNI 4535

M	mm	L	L1	€	W	U
6x0,75	4,5	48	16	8,40	5	004330201
7x0,75	4,5	56	18	10,50	5	004330202
8x0,75	5,0	50	16	10,50	5	004330203
8x1	5,0	56	16	10,50	5	004330204
9x0,75	6,0	63	22	13,60	5	004330205
9x1	6,0	63	22	13,60	5	004330206
10x0,75	6,5	63	18	13,60	5	004330207
10x1	6,5	63	18	13,60	5	004330208
10x1,25	6,5	63	18	13,60	5	004330209
11x0,75	7,0	70	25	18,40	3	004330210
11x1	7,0	70	25	18,40	3	004330211
11x1,25	7,0	70	25	18,40	3	004330212
12x0,75	7,0	70	20	17,80	3	004330213
12x1	7,0	70	20	17,80	3	004330214
12x1,25	7,0	70	20	17,80	3	004330215
12x1,5	7,0	70	20	17,80	3	004330216
14x1	8,0	80	32	23,30	1	004330217
14x1,25	8,0	80	32	23,30	1	004330218
14x1,5	8,0	80	32	23,30	1	004330219
16x1	10,0	80	32	27,50	1	004330220
16x1,5	10,0	80	32	27,50	1	004330221
18x1,5	11,0	95	40	32,50	1	004330222
18x2	11,0	80	25	42,50	1	004330223
20x1,5	14,5	80	22	48,00	1	004330224
22x1,5	14,5	80	22	57,50	1	004330225
24x1,5	14,5	80	22	67,00	1	004330226
24x2	14,5	80	22	66,50	1	004330227

433ASF

hand taps, fine pitch, UNF thread
made from chrome-steel



ANSI B.1

UNF	mm	L	L1	€	W	U
1/4x28	4,9	70	30	10,60	5	004330301
5/16x24	4,9	70	30	12,70	5	004330302
3/8x24	5,5	75	35	14,30	3	004330303
7/16x20	6,2	80	40	18,20	3	004330304
1/2x20	7,0	85	45	23,10	3	004330305
9/16x18	9,0	90	45	28,50	3	004330306
5/8x18	9,0	100	47	32,50	3	004330307
3/4x16	11,0	110	50	44,50	3	004330308
7/8x14	14,5	120	60	57,00	1	004330309
1"x12	16,0	130	60	77,50	1	004330310

433ASG

hand taps, cylindrical GAS (BSP) thread
made from chrome-steel



DIN 5157

GAS	mm	L	L1	€	W	U
1/8x28	5,5	65	18	15,10	1	004330401
1/4x19	9,0	70	24	19,30	1	004330402
3/8x19	9,0	75	25	23,30	1	004330403
1/2x14	12,0	80	31	33,00	1	004330405
3/4x14	16,0	90	33	54,50	1	004330408
1"x11	20,0	100	39	88,00	1	004330410

434

hand taps, fine pitch, metric thread HSS

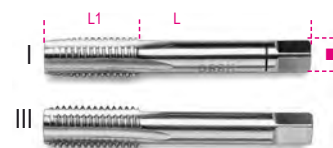

DIN 2181 UNI 4535

M	mm	L	L1	€	W	U
6x0,75	4,5	48	16	23,90	5	004340001
8x0,75	5,0	56	16	28,00	5	004340003
8x1	5,0	56	16	28,00	5	004340004
10x0,75	6,5	63	18	35,50	5	004340007
10x1	6,5	63	18	35,50	5	004340008
10x1,25	6,5	63	18	35,50	5	004340009
12x1	7,0	70	20	37,50	3	004340014
12x1,25	7,0	70	20	37,50	3	004340015
12x1,5	7,0	70	20	37,50	3	004340016
13x1,5	9,0	70	20	79,00	1	004340017
14x1	9,0	70	20	47,00	1	004340018
14x1,25	9,0	70	20	47,00	1	004340019
14x1,5	9,0	70	20	40,50	1	004340020
15x1,5	9,0	70	20	79,00	1	004340021
16x1	9,0	70	20	51,00	1	004340022
16x1,5	9,0	70	20	44,00	1	004340023
18x1,5	11,0	80	22	56,50	1	004340024
18x2	11,0	90	25	68,50	1	004340025
20x1,25	12,0	80	22	97,00	1	004340026
20x1,5	12,0	80	22	60,50	1	004340027
20x2	12,0	90	25	74,50	1	004340028
22x1,5	14,5	80	22	86,00	1	004340029
24x1	14,5	80	22	115,50	1	004340030
24x1,5	14,5	80	22	97,00	1	004340031
24x2	14,5	80	22	101,50	1	004340032

Beta

435

adjustable tap wrenches, steel body



DIN 1814

	□ mm	L mm	€	🔧	📦
435/0	2÷5 M1÷M8	170	16,30	3	004350007
435/1	2÷6 M1÷M10	200	19,60	2	004350009
435/1,5	2,5÷6 M1÷M12	200	20,80	2	004350011
435/2	3÷7 M4÷M12	260	29,00	2	004350013
435/3	4÷12 M5÷M20	345	49,00	1	004350020
435/4	5,5÷16 M9÷M27	430	76,00	1	004350027
435/5	7÷18 M13÷M32	770	172,50	1	004350032

435G

adjustable tap wrenches,
light alloy body



DIN 1814

	□ mm	L mm	€	🔧	📦
435G/0	2÷5 M1÷M8	130	11,60	5	004350108
435G/1	2÷6 M1÷M10	190	14,10	5	004350110
435G/1,5	2÷7 M2÷M12	175	14,80	5	004350112
435G/2	3,4÷7 M4÷M12	280	24,40	5	004350114
435G/3	4,9÷12 M5÷M20	380	39,00	2	004350121
435G/4	7÷16 M11÷M27	500	62,50	2	004350127
435G/5	7÷18 M13÷M32	700	98,50	1	004350132
435G/6	11÷24 M18÷M42	800	162,50	1	004350142

436

reversible ratcheting tap wrenches

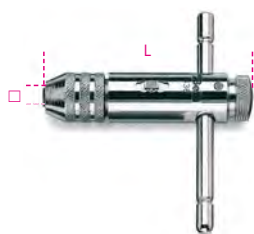

	□ mm	L mm	€	🔧	📦
436/1	2÷5 M3÷M8	85	27,00	5	004360002
436/2	4,6÷8 M5÷M12	110	34,50	5	004360004

436L

reversible ratcheting tap wrenches,
long series



	□ mm	L mm	€	🔧	📦
436L/1	2÷5 M3÷M8	245	43,00	2	004360012
436L/2	4,6÷8 M5÷M12	295	50,00	2	004360014

436R

spare clamps for items 436 and 436L

	€	🔧	📦
436R/1	5,05	1	004360022
436R/2	5,70	1	004360024

437P

thread dresser,
for repairing internal and external, right-hand
and left-hand threads

P 0.80÷3.00 mm

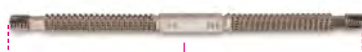

L mm	€	🔧	📦
230	44,50	1	004370003

437C

set for repairing damaged spark plug threads,
M14x1.25 mm

• Helicoids height: 8.40 - 12.40 - 16.40 mm (5 pcs/size)



437C	€	🔧	📦
	114,50	1	004370100

437C/...

stainless steel helicoids for item 437C



H mm	€	🔧	📦
8.4	29,00	1	004370108
12.4	29,00	1	004370112
16.4	29,00	1	004370116

The prices shown are for 10 pieces

437C/RM14

male thread for spark plugs M14x1.25



437C/RM14	€	🔧	📦
	95,00	1	004370124

437K/8

tool assortment for repairing
axle shaft threads

- Allows original thread to be rectified and dressed.
- Kit contents:
 - Metric sizes: 20x1.25 - 20x1.5 - 22x1.00 - 22x1.5 - 24x1.5 - 24x2.00
 - Inch sizes: 3/4x20 - 13/16x20



⊘ 32 mm

437K/8	€	🔧	📦
	75,50	1	004370020

≡ 200x110x30 mm

437K/9

tool assortment for repairing male and female
threads, wheel fixing screws

allows original thread to be rectified and dressed

- Kit contents:
 - Taps: M12x1.25 - M12x1.5 - M12x1.75 - M14x1.5
 - Dies: M12x1.25 - M12x1.5 - M14x1.5



⊘ 12 - 24 mm

437K/9	€	🔧	📦
	79,00	1	004370029

≡ 161x123x50 mm

Beta
Quality Tools

Beta

437K/10

assortment for repairing damaged threads on oxygen sensors M18x1.5

- Kit contents:
- 1 pilot reamer M18
 - 1 tap M18x1.5
 - 1 tap M20x1.5
 - 5 threaded bushes M18x1.5
 - 1 bushing tool



⊘ 13 - 27 mm

437K/10 € 119,50 1 004370030
190x105x40 mm

437K/12

tool assortment for repairing axle shaft threads

allows original thread to be rectified and dressed

- Kit contents:
- Metric sizes: M16x1.0 - M16x1.5 - M20x1.0 - M20x1.5 - M22x1.5 - M24x1.5 - M24x2.0 - M27x2.0
 - Inch sizes: 3/4x16 - 3/4x20 - 13/16x20 - 27/32x20



⊘ 32 - 35 mm

437K/12 € 95,00 1 004370032
220x118x52 mm

437K/16

tool assortment for repairing damaged threads on brake caliper brackets M9x1.25



437K/16 € 106,00 1 004370016
210x150x50 mm

437K/33

tool assortment for repairing damaged spark plug threads

- Bushes:
M8x1.0 - M10x1.0 - M10x1.25 - M12x1.25
- Taps:
M8x1.0 - M10x1.0 - M10x1.25 - M12x1.0 - M12x1.25 - M14x1.25



437K/33 € 265,00 1 004370133
210x150x50 mm

437U/09

assortment for repairing damaged threads M5-M6-M8-M10-M12



25 x M5, M6, M8, M10
10 x M12

437U/09 € 320,00 1 004370550
370x230x55 mm - 2 Kg

437U/E-M...

stainless steel helicoids



H mm	€	1	004370555
M5	7,5	17,00	1 004370555
M6	9	17,00	1 004370556
M8	12	23,50	1 004370558
M10	15	31,00	1 004370560
M12	18	19,50	1 004370562

Prices refer to 25 pieces (10 for size M12)

437U/PM

bits and taps for item 437U/09



M	€	1	004370565
M5	32,00	1 004370565	
M6	33,50	1 004370566	
M8	45,00	1 004370568	
M10	59,50	1 004370570	
M12	74,00	1 004370572	

438A

set of bits for drilling, threading and countersinking; HSS

- M3 - M4 - M5 - M6 - M8 - M10
- With magnetic bit holder



1/4
S MAX mm = Ø mm

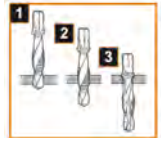

438A € 108,00 1 004380010

438...

bits for drilling, threading and countersinking

HSS, 1/4" drive

1/4



S max mm	€	2	004380103
M3	3	20,80	2 004380104
M4	4	20,80	2 004380105
M5	5	20,80	2 004380106
M6	6	20,80	2 004380108
M8	8	23,40	2 004380110
M10	10	23,40	2 004380110

440

round dies, coarse pitch, metric thread made from chrome-steel

R ≤ 600 N/mm²
HRC 60±61



UNI 4535
DIN 223

M	Ø x S mm	€	5	004400002
2x0,4	25,4 x 9	16,40	5 004400003	
3x0,5	25,4 x 9	12,10	5 004400004	
4x0,7	25,4 x 9	12,10	5 004400005	
5x0,8	25,4 x 9	10,40	5 004400006	
6x1	25,4 x 9	10,40	5 004400007	
7x1	25,4 x 9	10,40	5 004400008	
8x1,25	25,4 x 9	10,40	5 004400009	
9x1,25	25,4 x 9	10,40	5 004400010	
10x1,5	25,4 x 9	10,40	5 004400012	
12x1,75	25,4 x 9	10,40	5 004400012	

440A

round dies, **coarse pitch**,
metric thread made from chrome-steel

R ≤ 600 N/mm²
HRC || 60+61



UNI 4535
DIN 223

M	Ø x S mm	€	Hand	Machine
10x1,5	38,1 x 14	14,80	3	004400110
11x1,5	38,1 x 14	14,80	3	004400111
12x1,75	38,1 x 14	14,80	3	004400112
14x2	38,1 x 14	14,80	3	004400114
16x2	38,1 x 14	14,80	3	004400116
18x2,5	38,1 x 14	17,10	3	004400118
20x2,5	38,1 x 14	18,90	3	004400120

440B

round dies, **coarse pitch**,
metric thread made from chrome-steel

R ≤ 600 N/mm²
HRC || 60+61



UNI 4535
DIN 223

M	Ø x S mm	€	Hand	Machine
18x2,5	50,8 x 16	26,00	3	004400122
20x2,5	50,8 x 16	27,50	3	004400124
22x2,5	50,8 x 16	29,50	3	004400126
24x3	50,8 x 16	30,00	3	004400128

440ASW

round dies, **Whitworth** thread
made from chrome-steel

R ≤ 600 N/mm²



UNI EN 22568
DIN 223

BSW	Ø x S mm	€	Hand	Machine
1/8x40	25,4 x 9	13,90	5	004400201
5/32x32	25,4 x 9	13,90	5	004400202
3/16x24	25,4 x 9	12,50	5	004400203
1/4x20	25,4 x 9	12,50	5	004400204
5/16x18	25,4 x 9	12,50	5	004400205
3/8x16	38,1 x 14	17,80	3	004400206
7/16x14	38,1 x 14	17,80	3	004400207
1/2x12	38,1 x 14	18,40	3	004400208
9/16x12	38,1 x 14	18,40	3	004400209
5/8x11	50,8 x 16	32,00	3	004400210
3/4x10	50,8 x 16	32,00	3	004400211
7/8x9	50,8 x 16	36,50	3	004400212
1"x8	50,8 x 16	36,50	3	004400213

440ASC

round dies, **coarse pitch**,
UNC thread made from chrome-steel

R ≤ 600 N/mm²



UNI EN 22568
DIN 223

UNC	Ø x S mm	€	Hand	Machine
1/4x20	25,4 x 9	12,40	5	004400221
5/16x18	25,4 x 9	12,40	5	004400222
3/8x16	38,1 x 14	17,10	3	004400223
7/16x14	38,1 x 14	17,10	3	004400224
1/2x13	38,1 x 14	17,10	3	004400225
9/16x12	38,1 x 14	17,10	3	004400226
5/8x11	50,8 x 16	36,00	3	004400227
3/4x10	50,8 x 16	36,00	3	004400228
7/8x9	50,8 x 16	36,00	3	004400229
1"x8	50,8 x 16	36,00	3	004400230

440ASF

round dies, **fine pitch**,
UNF thread made from chrome-steel

UNI EN 2258
DIN 223

UNF	Ø x S mm	€	Hand	Machine
1/4x28	25,4 x 9	13,10	5	004400241
5/16x24	25,4 x 9	13,10	5	004400242
3/8x24	38,1 x 14	18,70	3	004400243
7/16x20	38,1 x 14	18,70	3	004400244
1/2x20	38,1 x 14	18,70	3	004400245
9/16x18	38,1 x 14	18,70	3	004400246
5/8x18	50,8 x 16	37,50	3	004400247
3/4x16	50,8 x 16	37,50	3	004400248
7/8x14	50,8 x 16	37,50	3	004400249
1"x12	50,8 x 16	37,50	3	004400250

440ASG

round dies, cylindrical **GAS** (BSP) thread
made from chrome-steel

R ≤ 600 N/mm²



UNI EN 24231
DIN 223

GAS	Ø x S mm	€	Hand	Machine
1/8x28	38,1 x 14	14,80	3	004400255
1/4x19	38,1 x 14	14,80	3	004400256
3/8x19	38,1 x 14	14,80	3	004400257
1/2x14	50,8 x 16	30,00	3	004400259
3/4x14	50,8 x 16	30,00	3	004400260
1"x11	63,5 x 19	59,50	3	004400261

441

round dies, **fine pitch**, metric thread
made from chrome-steel

R ≤ 600 N/mm²
HRC || 60+61

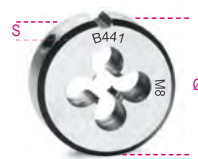

UNI 4535
DIN 223

M	Ø x S mm	€	Hand	Machine
6x0,75	25,4 x 9	12,50	5	004410004
7x0,75	25,4 x 9	12,50	5	004410005
8x0,75	25,4 x 9	12,50	5	004410006
8x1	25,4 x 9	12,50	5	004410007
9x0,75	25,4 x 9	12,50	5	004410008
9x1	25,4 x 9	12,50	5	004410009

441A

round dies, **fine pitch**, metric thread
made from chrome-steel

R ≤ 600 N/mm²
HRC || 60+61



UNI 4535
DIN 223

M	Ø x S mm	€	Hand	Machine
10x0,75	38,1 x 14	18,70	3	004410100
10x1	38,1 x 14	18,70	3	004410101
10x1,25	38,1 x 14	18,70	3	004410102
11x0,75	38,1 x 14	18,70	3	004410103
11x1	38,1 x 14	18,70	3	004410104
11x1,25	38,1 x 14	18,70	3	004410105
12x0,75	38,1 x 14	18,70	3	004410106
12x1	38,1 x 14	18,70	3	004410107
12x1,25	38,1 x 14	18,70	3	004410108
12x1,5	38,1 x 14	18,70	3	004410109
14x1	38,1 x 14	18,70	3	004410110
14x1,25	38,1 x 14	18,70	3	004410111
14x1,5	38,1 x 14	18,70	3	004410112
16x1	38,1 x 14	18,70	3	004410113
16x1,5	38,1 x 14	18,70	3	004410114
18x1,5	38,1 x 14	18,70	3	004410115



441B

round dies, **fine pitch**, metric thread made from chrome-steel

R ≤ 600 N/mm²
HRC 60±61



UNI 4535
DIN 223

M	Ø x S mm	€	📦	📄
18x1,5	50,8 x 16	35,00	3	004410117
18x2	50,8 x 16	35,00	3	004410118
20x1,5	50,8 x 16	35,50	3	004410119
22x1,5	50,8 x 16	36,50	3	004410120
24x1,5	50,8 x 16	37,00	3	004410121
24x2	50,8 x 16	37,00	3	004410122

442

round dies, **coarse pitch**, metric thread HSS

HRC 62±63
AISI M2



UNI EN 22568
DIN 223

M	Ø x S mm	€	📦	📄
3x0,5	20x5	14,50	3	004420003
4x0,7	20x5	14,50	3	004420004
5x0,8	20x7	14,80	3	004420005
6x1	20x7	14,80	3	004420006
7x1	25x9	16,50	3	004420007
8x1,25	25x9	16,50	3	004420008
10x1,5	30x11	18,70	3	004420010
12x1,75	38x14	31,50	3	004420012
14x2	38x14	40,50	1	004420014
16x2	45x18	51,50	1	004420016
18x2,5	45x18	54,50	1	004420018
20x2,5	45x18	54,50	1	004420020
22x2,5	55x22	79,00	1	004420022
24x3	55x22	79,00	1	004420024

443

round dies, **fine pitch**, metric thread HSS

HRC 62±63
AISI M2



UNI EN 22568
DIN 223

M	Ø x S mm	€	📦	📄
6x0,75	20x7	24,90	1	004430107
8x0,75	25x9	27,50	1	004430110
8x1	25x9	26,00	1	004430111
10x0,75	30x11	34,00	1	004430113
10x1	30x11	30,00	1	004430114
10x1,25	30x11	30,00	1	004430115
12x1	38x10	49,50	1	004430116
12x1,25	38x10	49,50	1	004430117
12x1,5	38x10	49,50	1	004430118

M	Ø x S mm	€	📦	📄
13x1,5	38x10	59,00	1	004430119
14x1	38x10	49,50	1	004430120
14x1,25	38x10	49,50	1	004430121
14x1,5	38x10	49,50	1	004430122
15x1,5	38x10	66,00	1	004430123
16x1	45x14	73,00	1	004430124
16x1,5	45x14	73,00	1	004430125
18x1,5	45x14	73,00	1	004430127
20x1,25	45x14	75,50	1	004430129
20x1,5	45x14	75,50	1	004430130
20x2	45x14	75,50	1	004430131
22x1,5	55x16	91,00	1	004430132
24x1	55x16	94,00	1	004430133
24x1,5	55x16	94,00	1	004430135
24x2	55x16	99,50	1	004430136

444

die stocks, steel body



EN 22568
DIN 225

	Ø mm	L mm	€	📦	📄
444	20x5	190	19,70	5	004440005
444/0	20x7	190	19,70	5	004440007
444/1	25,4x9,5	210	20,60	5	004440025
444/1A	25x9	215	21,10	5	004440027
444/1B	30x11	250	24,20	5	004440030
444/C	38x10	310	31,00	3	004440033
444/1C	38x14	310	31,00	3	004440035
444/2	38,1x12,7	300	32,00	3	004440038
444/1D	45x14	445	44,00	1	004440045
444/2D	45x18	445	44,00	1	004440046
444/3	50,8x15,9	520	63,00	1	004440050
444/4	55x16	495	63,00	1	004440055
444/5A	63,5x19	520	108,50	1	004440057

444G

die stocks, light alloy body



UNI EN 22568
DIN 225

	Ø mm	L mm	€	📦	📄
444G/A	16x5	160	9,30	5	004440103
444G	20x5	185	10,70	5	004440105
444G/0	20x7	185	10,70	5	004440107
444G/1	25,4x9,5	215	13,00	5	004440125
444G/1A	25x9	215	13,00	5	004440127
444G/1B	30x11	265	16,80	5	004440130
444G/C	38x10	315	24,10	3	004440133
444G/1C	38x14	315	24,10	3	004440135
444G/2	38,1x12,6	310	24,10	3	004440138
444G/1D	45x14	450	32,00	1	004440145
444G/2D	45x18	450	33,00	1	004440146
444G/3	50,8x16	485	34,50	1	004440150
444G/4	55x16	560	41,50	1	004440155
444G/5A	63,5x19	630	73,00	1	004440163
444G/6	65x18	630	77,00	1	004440165

446/C30

assortment of chrome-steel taps and dies, metric thread, and accessories in wooden case



€ 300,00 1 004460055

325x220x35 mm - 3,2 Kg

30	40	435/1,5	444/1
430 M mm	440 M mm		
3x0,5	3x0,5		
4x0,7	4x0,7		
5x0,8	5x0,8		
6x1	6x1		
8x1,25	8x1,25		
10x1,5	10x1,5		
12x1,75	12x1,75		

446/C48

assortment of chrome-steel taps and dies, metric thread, and accessories in wooden case



€ 570,00 1 004460057

580x300x50 mm - 5 Kg

30	40	440A	435/1	444/1
430 M mm	440 M mm	440A M mm		
3x0,5	3x0,5	10x1,5		
4x0,7	4x0,7	12x1,75		
5x0,8	5x0,8	14x2		
6x1	6x1	16x2		
8x1,25	8x1,25	18x2,5		
10x1,5		20x2,5		
12x1,75				
14x2				
16x2				
18x2,5				
20x2,5				

446/C110

assortment of chrome-steel taps and dies, metric thread, and accessories for car repair jobs in wooden case



446/C110 € 823,00 1 004460060

500x337x60 mm - 8,1 Kg

430	433	440/440A	441/441A
M mm	M mm	M mm	M mm
2x0,4	6x0,75	2x0,4	6x0,75
3x0,5	7x0,75	3x0,5	7x0,75
4x0,7	8x0,75	4x0,7	8x0,75
5x0,8	8x1	5x0,8	8x1
6x1	9x0,75	6x1	9x0,75
7x1	9x1	7x1	9x1
8x1,25	10x0,75	8x1,25	10x0,75
9x1,25	10x1	9x1,25	10x1
10x1,5	10x1,25	10x1,5	10x1,25
11x1,5	11x0,75	11x1,5	11x0,75
12x1,75	11x1	12x1,75	11x1
14x2	11x1,25	14x2	11x1,25
16x2	12x0,75	16x2	12x0,75
	12x1		12x1
	12x1,25		12x1,25
	12x1,5		12x1,5
	14x1		14x1
	14x1,25		14x1,25
	14x1,5		14x1,5
	16x1		16x1
	16x1,5		16x1,5
	18x1,5		18x1,5

435/0	444/1	436/1
435/3	444/2	

446ASF/C29

assortment of chrome-steel taps and dies, UNF thread, and accessories in wooden case



446ASF/C29 € 652,00 1 004460070

660x410x50 mm - 6 Kg

433ASF	440ASF		
1/4	1/4	435/1,5	444/1
5/16	5/16	435/3	444/2
3/8	3/8		444/3
7/16	7/16		
1/2	1/2		
9/16	9/16		
5/8	5/8		
3/4	3/4		

446ASW/C36

assortment of chrome-steel taps and dies, Whitworth thread, and accessories in wooden case



446ASW/C36 € 482,00 1 004460075

525x310x50 mm - 3,4 Kg

430ASW	440ASW		
1/8	1/8	435/1,5	444/1
5/32	5/32	435/2	444/2
3/16	3/16		
1/4	1/4		
5/16	5/16		
3/8	3/8		
7/16	7/16		
1/2	1/2		

446ASC/C37

assortment of chrome-steel taps and dies, UNC thread, and accessories in wooden case



446ASC/C37 € 698,00 1 004460080

660x410x50 mm - 6,7 Kg

430ASC	440ASC		
1/4	1/4	435/1,5	444/1
5/16	5/16	435/3	444/2
3/8	3/8		444/3
7/16	7/16		
1/2	1/2		
9/16	9/16		
5/8	5/8		
3/4	3/4		

446ASG/C23

assortment of chrome-steel taps and dies, cylindrical GAS thread, and accessories in wooden case



446ASG/C23 € 1.016,00 1 004460085

700x430x70 mm - 9,8 Kg

433ASG	440ASG		
1/8	1/8	435/3	444/2
1/4	1/4	435/5	444/3
3/8	3/8		444/5A
1/2	1/2		
3/4	3/4		
1"	1"		

447/C37

assortment of HSS taps and dies, metric thread, and accessories in metal case



447/C37 € 613,00 1 004470055

380x185x35 mm - 3,9 Kg

431 M mm	442 M mm		
3x0,5	3x0,5	435/0	444
4x0,7	4x0,7	435/2	444/0
5x0,8	5x0,8		444/1A
6x1	6x1		444/1B
8x1,25	8x1,25		444/1C
10x1,5	10x1,5		
12x1,75	12x1,75		

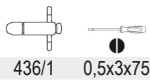

447/C53

assortment of HSS taps and dies, metric thread, and accessories in metal case



447/C53 € 1.260,00 1 004470060

500x235x50 mm - 9 Kg

431 M mm	442 M mm			
3x0,5	3x0,5	435/1,5	444	436/1
4x0,7	4x0,7	435/3	444/0	436/2
5x0,8	5x0,8		444/1A	
6x1	6x1		444/1B	
8x1,25	8x1,25		444/1C	
10x1,5	10x1,5		444/2D	
12x1,75	12x1,75			
14x2	14x2			
16x2	16x2			
18x2,5	18x2,5			
20x2,5	20x2,5			

447/C70

assortment of HSS taps and dies, metric thread, and accessories for car repair jobs industrial maintenance in wooden case



447/C70 € 1.585,00 1 004470065

510x340x70 mm - 7,5 Kg

431 M mm	434 M mm	442 M mm	443 M mm
3x0,5	8x1	3x0,5	8x1
4x0,7	10x1,25	4x0,7	10x1,25
5x0,8	12x1,25	5x0,8	12x1,25
6x1	12x1,5	6x1	12x1,5
7x1	14x1,25	7x1	14x1,25
8x1,25	14x1,5	8x1,25	14x1,5
10x1,5	16x1,5	10x1,5	16x1,5
12x1,75		12x1,75	
14x2		14x2	
16x2		16x2	

435/0	444	436/1
435/3	444/0	
	444/1A	
	444/1B	
	444/C	
	444/1C	
	444/1D	
	444/2D	

450

holesaws HSS, Bimetal



HSS-Co 8%

Ø mm	Ø	A mm	€		
16	(5/8)	57	15,80	1	004500016
17	(11/16)	57	15,80	1	004500017
19	(3/4)	51	15,80	1	004500019
20	-	51	15,80	1	004500020
21	(13/16)	51	15,80	1	004500021
22	(7/8)	51	15,80	1	004500022
24	(15/16)	51	15,80	1	004500024
25	(1")	51	17,30	1	004500025
27	(1"1/16)	51	18,00	1	004500027
29	(1"1/8)	51	18,00	1	004500029
30	(1"3/16)	51	18,00	1	004500030
32	(1"1/4)	51	18,00	1	004500032
33	(1"5/16)	51	18,50	1	004500033
35	(1"3/8)	51	20,80	1	004500035

Ø mm	Ø	A mm	€		
37	(1"7/16)	51	20,80	1	004500037
38	(1"1/2)	44	21,30	1	004500038
40	(1"9/16)	44	21,90	1	004500040
41	(1"5/8)	44	22,50	1	004500041
43	(1"11/16)	44	22,50	1	004500043
44	(1"3/4)	44	23,30	1	004500044
46	(1"13/16)	44	23,30	1	004500046
48	(1"7/8)	44	23,90	1	004500048
51	(2")	44	24,70	1	004500051
52	(2"1/16)	44	27,50	1	004500052
54	(2"1/8)	44	27,50	1	004500054
57	(2"1/4)	44	27,50	1	004500057
59	(2"5/16)	44	28,50	1	004500059
60	(2"3/8)	44	28,50	1	004500060
64	(2"1/2)	44	30,00	1	004500064
65	(2"9/16)	44	30,00	1	004500065
67	(2"5/8)	44	30,00	1	004500067
68	-	44	30,00	1	004500068
70	(2"3/4)	44	31,00	1	004500070
73	(2"7/8)	44	31,00	1	004500073
76	(3")	44	32,00	1	004500076
79	(3"1/8)	44	34,00	1	004500079
83	(3"1/4)	44	35,50	1	004500083
86	(3"3/8)	44	35,50	1	004500086
89	(3"1/2)	44	36,50	1	004500089
92	(3"5/8)	44	39,00	1	004500092
95	(3"3/4)	44	41,00	1	004500095
98	(3"7/8)	44	42,00	1	004500098
102	(4")	44	44,00	1	004500102
105	(4"1/8)	44	47,00	1	004500105
108	(4"1/4)	44	59,00	1	004500108
111	(4"3/8)	44	67,00	1	004500111
114	(4"1/2)	44	79,00	1	004500114
121	(4"3/4)	44	88,00	1	004500121
127	(5")	44	96,50	1	004500127
140	(5"1/2)	44	117,00	1	004500140
152	(6")	44	136,00	1	004500152

450AL

arbors for holesaws

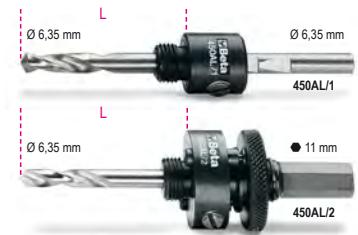

	Ø mm	L mm	€		
450AL/1	16÷30	54	19,30	1	004500210
450AL/2	32÷152	70	45,00	1	004500215

450AD

adaptors for arbors item 450AL/1



	Ø mm	€		
450AD	32÷51	7,60	1	004500230



450PA/1

pilot drills for arbors item 450AL/1, HSS

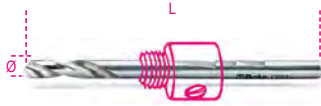

ØxL mm	€		
6,35x105	12,00	1	004500252

450PA/2

pilot drills for arbors item 450AL/2, HSS

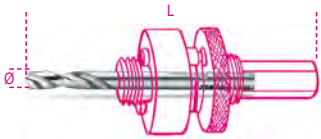

ØxL mm	€		
6,35x80	12,00	1	004500253

450PR

extension for holesaws



L mm	€		
305	32,50	1	004500255

450/C9

assortment of holesaws and accessories for electricians



HSS-Co 8%

450/C9	€		
	229,00	1	004500305

450 Ø 22 - 29 - 35 - 44 - 51 - 64 mm

450AL /1 - /2

450AD

220x160x60 mm - 1,6 Kg

450/C13

assortment of holesaws and accessories for installers



HSS-Co 8%

450/C13	€		
	287,00	1	004500310

450 Ø 19 - 22 - 29 - 35 - 38

44 - 51 - 57 - 64 mm

450AL /1 - /2

450PA/1

450AD

215x180x65 mm - 1,8 Kg

450/C15

assortment of holesaws and accessories for electricians



450/C15	€		
	376,00	1	004500313

450 Ø 16 - 20 - 25 - 32 - 40

51 - 60 - 65 - 70 mm

450AL /1 - /2

450PA /1 - /2

450PR

450AD

420x185x60 mm - 3,2 Kg

450/C21

assortment of holesaws and accessories for industrial use



HSS-Co 8%

450/C21	€		
	656,00	1	004500315

450 Ø 19 - 22 - 29 - 35 - 38

44 - 51 - 57 - 64 - 76

83 - 92 - 95 - 105 - 114 mm

450AL /1 - /2

450PA /1 - /2

450PR

450AD

420x280x60 mm - 7 Kg

451

hole cutters HSS, entirely ground

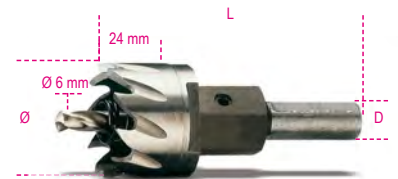

Ø mm	L mm	D mm	€		
12	85	8	23,70	1	004510012
13	85	8	23,70	1	004510013
14	85	8	24,20	1	004510014
15	85	10	24,20	1	004510015
16	85	10	24,20	1	004510016
17	85	10	24,20	1	004510017
18	85	10	24,20	1	004510018
19	85	10	24,70	1	004510019
20	85	10	26,00	1	004510020
21	85	10	28,00	1	004510021
22	85	10	29,00	1	004510022
23	85	10	30,50	1	004510023
24	85	10	31,50	1	004510024
25	85	10	32,50	1	004510025
26	90	10	34,50	1	004510026
27	90	10	35,50	1	004510027
28	90	10	36,00	1	004510028
29	90	10	37,00	1	004510029
30	90	10	37,50	1	004510030
31	90	10	40,00	1	004510031
32	90	10	41,00	1	004510032
33	90	10	42,50	1	004510033
34	90	10	44,00	1	004510034
35	90	10	45,00	1	004510035
36	85	10	46,00	1	004510036
37	85	10	47,00	1	004510037
38	85	10	48,00	1	004510038
39	85	10	49,50	1	004510039
40	85	10	50,50	1	004510040
41	85	10	52,00	1	004510041
42	85	10	54,50	1	004510042
43	85	10	56,00	1	004510043
44	85	10	57,00	1	004510044
45	85	10	58,50	1	004510045
46	85	10	58,50	1	004510046
47	85	10	60,50	1	004510047
48	85	10	63,00	1	004510048
49	85	10	65,00	1	004510049
50	85	10	65,00	1	004510050



451GA

arbors for hole cutters item 451



M	Ø mm	L mm	D mm	€	🔧	📄
10x1,25	12÷14	57	8	13,50	1	004510101
12x1,25	15÷34	57	10	13,50	1	004510102
14x1,5	35÷50	57	10	16,50	1	004510105

451PA

pilot drill for hole cutters item 451
HSS



Ø mm	L mm	€	🔧	📄
6	53	7,60	1	004510103

451PR

extension for hole cutters item 451



M	Ø mm	L mm	Ø1 mm	€	🔧	📄
12x1,25	15÷34	400	13	59,00	1	004510104
14x1,5	35÷50	400	13	59,00	1	004510108

452

hole cutters with hard metal insets

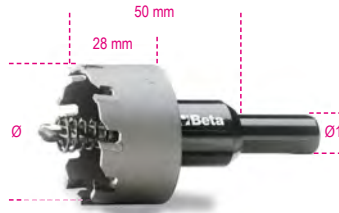

Ø mm	Ø1 mm	€	🔧	📄
15	10	97,00	1	004520015
16	10	97,00	1	004520016
17	10	97,00	1	004520017
18	10	97,00	1	004520018
19	10	97,00	1	004520019
20	10	97,00	1	004520020
21	10	97,00	1	004520021
22	10	97,00	1	004520022
23	10	97,00	1	004520023
24	10	97,00	1	004520024
25	10	97,00	1	004520025
26	10	109,00	1	004520026
27	10	109,00	1	004520027
28	10	109,00	1	004520028
29	10	109,00	1	004520029
30	10	109,00	1	004520030
31	10	132,00	1	004520031
32	10	132,00	1	004520032
33	10	132,00	1	004520033
34	10	132,00	1	004520034
35	10	132,00	1	004520035
36	10	153,00	1	004520036
37	10	153,00	1	004520037
38	10	153,00	1	004520038
39	13	153,00	1	004520039
40	13	153,00	1	004520040
41	13	172,50	1	004520041
42	13	172,50	1	004520042
43	13	172,50	1	004520043
44	13	172,50	1	004520044
45	13	172,50	1	004520045
46	13	194,00	1	004520046
47	13	194,00	1	004520047
48	13	194,00	1	004520048
49	13	194,00	1	004520049
50	13	194,00	1	004520050
55	13	220,00	1	004520055
60	13	292,00	1	004520060
65	13	292,00	1	004520065
70	13	341,00	1	004520070
75	13	371,00	1	004520075
80	13	403,00	1	004520080
85	13	454,00	1	004520085
90	13	482,00	1	004520090

452GA

arbors for hole cutters item 452



	Ø mm	€	🔧	📄
452GA/1	15÷21	12,10	1	004520125
452GA/2	22÷38	14,00	1	004520126
452GA/3	39÷100	16,80	1	004520127

460

hole cutters for building materials

- For concrete, cement, natural and artificial stones
- Maximum drilling depth: 60 mm

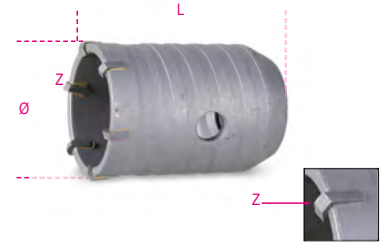

Ø mm	L mm	Z	€	🔧	📄
50	75	6	49,50	1	004600050
60	75	6	59,00	1	004600060
65	75	6	61,50	1	004600065
80	75	6	91,50	1	004600080
90	75	6	96,50	1	004600090
100	75	8	118,00	1	004600100
112	75	8	135,50	1	004600112
125	80	10	168,50	1	004600125
150	80	12	227,00	1	004600150

460PP

pilot drill for hole cutters for building materials
460



Ø mm	L mm	€	🔧	📄
8	120	5,60	1	004600201

460G

shanks for hole cutters 460



L mm	€	🔧	📄
220	30,50	1	004600222
370	43,00	1	004600237
460	67,50	1	004600246

TORQUE MULTIPLIERS

Torque multipliers are essential tools for tightening nuts and screws, as they allow a higher torque than the operator would normally apply to be generated, in small or hardly accessible spaces. They do not require bulky extensions, thereby ensuring total safety.

Beta's range of torque multipliers provides a variety of solutions and capacities **up to 9500 Nm**, and torque multiplication ratios up to 125:1. Many models – especially the most powerful ones – are fitted with a two-way anti-wind up system, to prevent dangerous tension returns onto the operator. Each of Beta's torque multipliers comes with a **certificate** proving that the tool was tested at the maximum value under optimal operating conditions.

Operating instructions

The torque multiplier **must be used with a torque wrench** to ensure control of the output torque; in addition, it must always be used with **impact sockets**.

The ratios of each torque multiplier determine the **multiplication factor** between the input torque and the output torque. Example: torque multiplier with 5:1 ratio. Applying an input torque of 100 Nm, as set on the torque wrench, will result in an output torque of 500 Nm as transmitted to the nut or screw.

However, make sure that all the parts involved in tightening are properly aligned.

Avoid using **extensions**, as these would twist, thereby producing a spring effect which would modify the applied torque values.

Always check that the **reaction arm** of the torque multiplier has been fixed to, or rests on, a sturdy structure, capable of withstanding the reaction force. As a rule, adequately rigid walls or screws near to the one that must be worked on are used. The reaction arm always rotates in the **opposite** direction to the tightening direction.

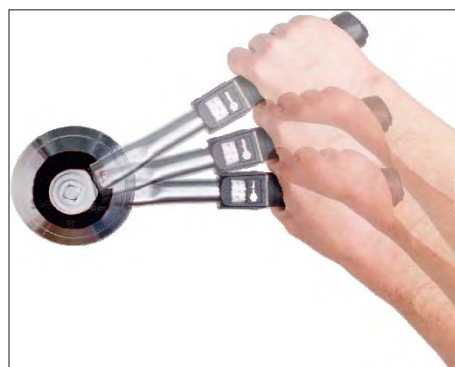

Operate smoothly and uninterruptedly.

Tightening tension must be released by rotating the torque multiplier in the other direction, before disengaging it; if the torque multiplier is fitted with an anti-wind up system, tightening tension must be released through the reversal lever.

The above instructions also apply to **unscrewing** operations.

560/C3

torque multiplier for right-hand and left-hand tightening, in plastic case, ratio 3.8:1, with anti-wind up system

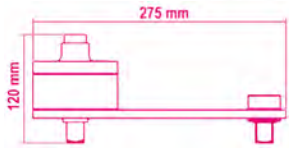

Nm	kgfm	lbf.ft	□	■	kg
1500	150	1110	1/2"	3/4"	3,9

560/C3 € 818,00 1 005600030

560/C3PLUS

torque multiplier for right-hand and left-hand tightening, in plastic case, ratio 3.8:1, with anti-wind up system

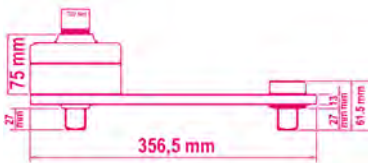

Nm	kgfm	lbf.ft	□	■	kg
2700	270	1991	3/4"	1"	7,5

560/C3PLUS € 953,00 1 005600038

560/C2

torque multiplier for right-hand and left-hand tightening, and accessories, ratio 5:1, in plastic case

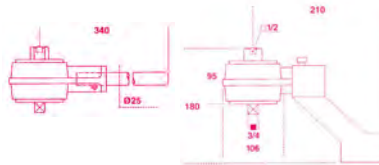

Nm	Kgfm	lbf.ft	□	■	kg
1300	130	960	1/2"	3/4"	3,8

	€		
560/C2	1.665,00	1	005600020
560/2	1.240,00	1	005600002
560/18	39,00	1	005600018
560/19	83,00	1	005600019
560/22	287,00	1	005600022

310x275x120 mm

560/C4+

torque multiplier for right-hand and left-hand tightening, and accessories, ratio 5:1, with reaction foot

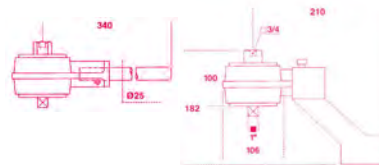
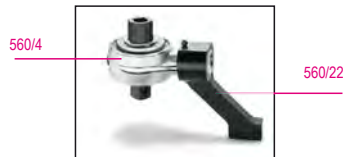

Nm	Kgfm	lbf.ft	□	■	kg
2700	270	2000	3/4"	1"	5

	€		
560/C4PLUS	1.635,00	1	005600042
560/4	1.290,00	1	005600004
560/18	39,00	1	005600018
560/22	287,00	1	005600022

310x275x120 mm

560/C6

torque multipliers for right-hand and left-hand tightening in plastic case ratio: 6.5:1



Nm	kgfm	lbf.ft	□	■	kg
1500	150	1106	1/2"	3/4"	6

560/C6 € 851,00 1 005600160

400x260x110 mm

560/C12

torque multipliers for right-hand and left-hand tightening in plastic case ratio: 12:1



Nm	kgfm	lbf.ft	□	■	kg
2500	250	1844	1/2"	1"	7

560/C12 € 1.225,00 1 005600210

400x260x110 mm

561/1

torque multiplier for right-hand and left-hand tightening, ratio 5:1, with two reaction feet

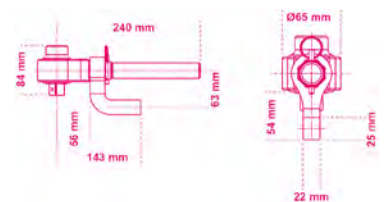

Nm	kgfm	lbf.ft	□	■	kg
1000	100	740	1/2"	3/4"	2,7

561/1 € 1.190,00 1 005610010

270x210x70 mm

562-1/VA - 562-2/VA

torque multipliers for right-hand and left-hand tightening
ratio 5,2:1
in case 562VV-A



Nm	Kgfm	lbf.ft	□	■	D	A	L min	L max	kg
1700	170	1250	3/4	1"	108	95	85	220	8,8

562-1/VA 2.640,00 1 005620601

Nm	Kgfm	lbf.ft	□	■	D	A	L min	L max	kg
3400	340	2500	3/4	1"	119	115	85	265	10,5

562-2/VA 3.190,00 1 005620602

564-3R/VA - 564-4R/VA

torque multipliers for right-hand and left-hand tightening
ratio 27:1
with anti-wind up system,
in case 562VV-A



Nm	Kgfm	lbf.ft	□	■	D	A	L min	L max	kg
3000	300	2200	1/2	1"	108	188	155	12,7	

564-3R/VA 5.160,00 1 005640603

Nm	Kgfm	lbf.ft	□	■	D	A	L min	L max	kg
6000	600	4500	1/2	1 1/2"	119	235	200	19,0	

564-4R/VA 6.090,00 1 005640604

565-1R/VA - 565-2R/VA - 565-3R/VA

torque multipliers for right-hand and left-hand tightening
ratio 27:1
with anti-wind up system,
in case 562VV-A



Nm	Kgfm	lbf.ft	□	■	D	A	L min	L max	kg
1700	170	1250	1/2	1"	108	125	80	215	11,2

565-1R/VA 4.280,00 1 005650611

Nm	Kgfm	lbf.ft	□	■	D	A	L min	L max	kg
3400	340	2500	1/2	1"	119	145	85	265	13,6

565-2R/VA 5.580,00 1 005650612

Nm	Kgfm	lbf.ft	□	■	D	A	L min	L max	kg
3400	340	2500	1/2	1 1/2"	119	145	85	265	14,2

565-3R/VA 5.900,00 1 005650613

565-4R/VB

torque multiplier for right-hand and left-hand tightening
ratio 27:1
with anti-wind up system,
in case 565VV-B

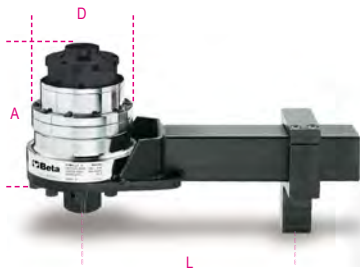

Nm	Kgfm	lbf.ft	□	■	D	A	L min	L max	kg
6000	600	4500	1/2	1 1/2"	144	180	125	335	22,4

565-4R/VB 6.660,00 1 005650614

565-5R/VB

torque multiplier for right-hand and left-hand tightening
ratio 27:1
with anti-wind up system,
in case 565VV-B

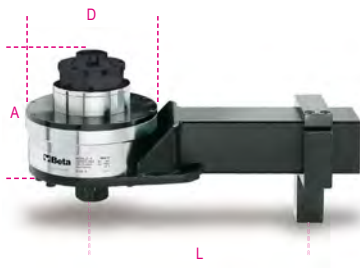

Nm	Kgfm	lbf.ft	□	■	D	A	L min	L max	kg
9500	950	7000	3/4	1 1/2"	184	180	155	355	30,4

565-5R/VB 11.330,00 1 005650615

567-4R/VB

torque multiplier for right-hand and left-hand tightening
ratio 135:1
with anti-wind up system,
in case 565VV-B

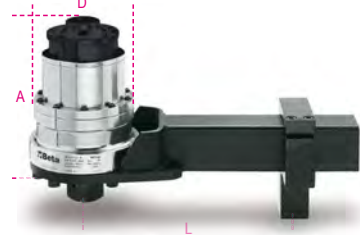

Nm	Kgfm	lbf.ft	□	■	D	A	L min	L max	kg
6000	600	4500	1/2	1 1/2"	144	210	125	335	24,4

567-4R/VB 7.400,00 1 005670614

567-5R/VB

torque multiplier for right-hand and left-hand tightening
ratio 135:1
with anti-wind up system,
in case 565VV-B

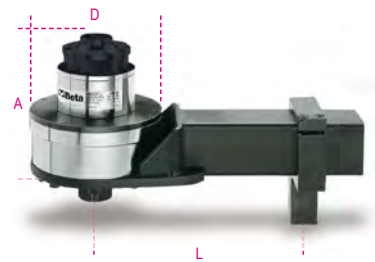

Nm	Kgfm	lbf.ft	□	■	D	A	L min	L max	kg
9500	950	7000	1/2	1 1/2"	184	210	155	350	32,4

567-5R/VB 12.700,00 1 005670615

562VV-A

multiplier case,
made of hard-wearing polypropylene with
sponge lining
Interior dimensions: 380x270x180 mm



562VV-A 226,00 1 005620501
562/1-562/2-564/3R
564/4R-565/1R-565/2R
565/3R

410x340x205 mm - 3,5 kg

565VV-B

multiplier case,
made of hard-wearing polypropylene with
sponge lining
Interior dimensions: 480x370x205 mm



565VV-B 306,00 1 005650502
565/4R-565/5R
567/4R-567/5R

520x435x230 mm - 5,4 kg

GUIDE TO TORQUE WRENCHES



Torque wrenches must always be held in the middle of the handle, in order not to change the lever ratio. They must be operated smoothly and uninterruptedly, avoiding jerks.



The adjustment scale must be reset to zero after use, in order not to affect tightening precision.



Beta provides a wide range of wrenches, with **four different types of operation**.

DIRECT READING MODELS

The applied tightening torque is transmitted directly to the reading index through compression of a coil spring. The applied torque can be read in real time through a pointer. A second pointer can be positioned on the target torque value. When the target torque value is reached, the second pointer will be hooked by the main pointer and record the peak value. Direct reading torque wrenches ensure remarkable accuracy and durability over time.

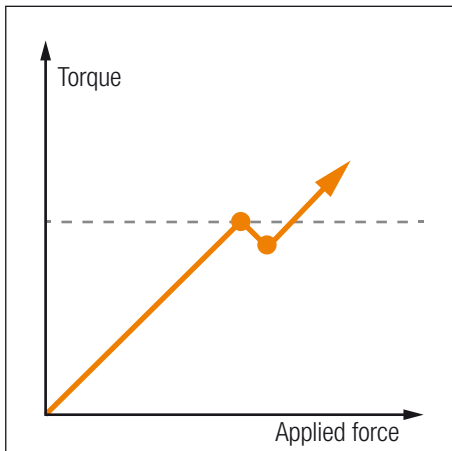

CLICK-TYPE MODELS

Click-type torque wrenches are the most popular models, as they are easy to use. They enable quick torque preselection by spring loading. The torque value increases as the applied force increases. When the required torque value is reached, a sudden release will occur, and the wrench will not apply any tightening force for approximately 3-5°. If the operator does not interrupt movement, the torque will keep increasing, thereby exceeding the required values.

BREAK-BACK MODELS

Break-back torque wrenches operate like click-type models, but when the required torque value is reached, a sudden release of the lever arm will occur (approximately 20°). Therefore, it is easier for the operator to stop applying force. They are normally used for high torque values with extremely long lever arms.

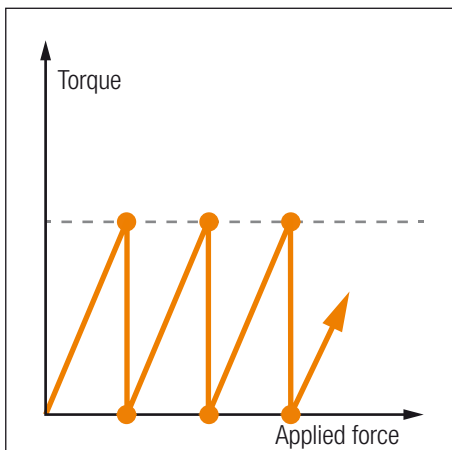
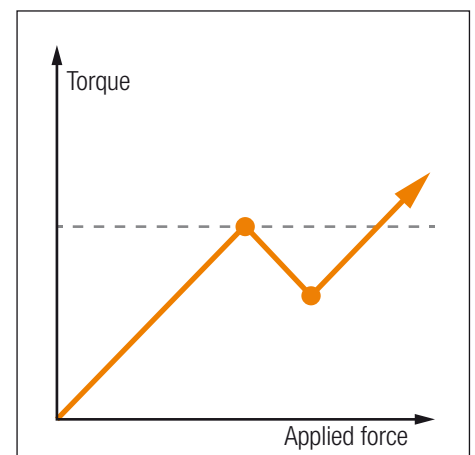

SLIPPING MODELS

When the pre-set torque value is reached, the slipping mechanism will stop the torque from being applied, thereby causing the tool to idle. This will prevent tightening with high torque values compared to the required ones. Keeping applying force will cause the same cycle to be repeated. They are ideal for operations in sequence with low torque values (electronic and micromechanical industries), where avoiding breaking delicate or small-sized parts is a priority.

FIELDS OF USE FOR TORQUE WRENCHES

1 Nm = 0,10197 Kgfm = 0,7375 lbf.ft



Size	Model	Image	Min (Nm)	Max (Nm)
14"	590		0,3	4
	590/1		0,5	13,5
	603/5		1	5
	603/10		2	10
	605E/5		1	5
	605E/10		2	10
	666N/2		5	25
38"	592/3		1	27
	592/4		3	40
	599DGT/6		12	60
	665/6		10	60
	665/10		20	100
	665LB/6		7 LBF.FT	45 LBF.FT
	665LB/10		15 LBF.FT	75 LBF.FT
	666N/2X		5	25
	666N/5		10	50
	666N/10		20	100
	666N LBF.IN/5		90 LBF.IN	440 LBF.IN
	666N LBF.IN/10		200 LBF.IN	800 LBF.IN
	668RGC/6		12	60
	668RGC/10		20	100
	12"	594/8		6
594/21			20	215
599DGT/10X			20	100
599DGT/20			40	200
599DGT/30			68	340
599DGT-AN/10			20	100
599DGT-AN/20			40	200
606MQ/50			5	50
610/5			90	130
610L/5			90	130
665/10X			20	100
665/20			40	200
665/30			60	330
665LB/10X			15 LBF.FT	75 LBF.FT
665LB/20			30 LBF.FT	150 LBF.FT
665LB/30			45 LBF.FT	240 LBF.FT
666N/10X			20	100
666N/20			40	200
666N/30			60	300
666N LBF.IN/10X			200 LBF.IN	800 LBF.IN
666N LBF.IN/20			400 LBF.IN	1800 LBF.IN
666N LBF.IN/30			500 LBF.IN	3000 LBF.IN
667N/20			40	200
667N/30			60	300
668RGC/10X			20	100
668RGC/20			40	200

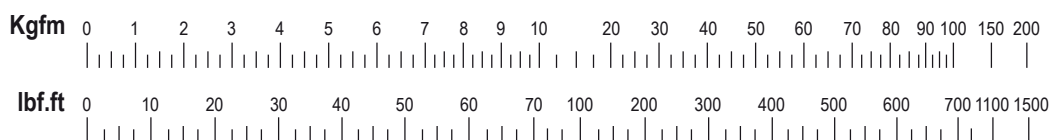

Beta

581

slip-torque screwdriver, ungraduated
for right-hand tightening
torque accuracy: $\pm 6\%$
(to be used with items 588 - 682)



UNI EN ISO 6789

Nm	gfm	lbf.in	kg
1,2÷6	120÷600	1/4"	275

581 € 267,00 1 005810001

583

slip-torque screwdriver, graduated
for right-hand tightening
torque accuracy: $\pm 6\%$



UNI EN ISO 6789

Nm	gfm	lbf.in	kg
0,3÷1,5	30÷150	1/4"	240

583/1,5 € 300,00 1 005830015

Nm	gfm	lbf.in	kg
0,6÷3	60÷300	1/4"	240

583/3 € 300,00 1 005830030

Nm	gfm	lbf.in	kg
1,2÷6	120÷600	1/4"	350

583/6 € 300,00 1 005830060

583/C31

1 torque screwdriver, 8 hexagon hand sockets,
20 bits and 2 accessories

1/4



583/C31 € 419,00 1 005830931

583/6	1.2 - 6 Nm
900	4-5-5,5-6-7-8-9-10 mm
860LP	0,6x4,5 - 1x5,5 - 1,2x6,5 mm
860PH	PH1 - PH2 (x2) - PH3
860PE	2-2,5-3-4-5 mm
860TX	T9-T10-T15-T20-T25-T27-T30-T40
882P/80	80 mm
892/0	● 1/4 ■ 1/4

270x120x45 mm - 1,2 kg

588

electronic digital torque meter

For testing and setting torque screwdrivers 581-583
Reading accuracy: $\pm 1\%$ of read value

CE



Nm	lbf.in	lbf.ft	kg
1÷10	10÷90	1/4"	1,8

588 € 2.020,00 1 005880001

590 - 592

direct reading torque wrenches
for right-hand and left-hand tightening
torque accuracy: $\pm 4\%$

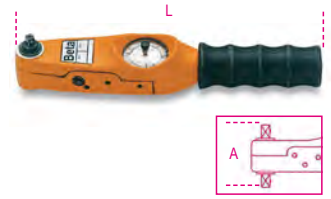

UNI EN ISO 6789

Nm	Kgfm	lbf.in	lbf.ft	A mm	L mm	kg
0,3÷4	0,03÷0,4	3÷35	1/4	60	253	0,52

590 € 709,00 1 005900001

Nm	Kgfm	lbf.in	lbf.ft	A mm	L mm	kg
0,5÷13,5	0,05÷1,35	4÷120	1/4	60	253	0,52

590/1 € 709,00 1 005900003

Nm	Kgfm	lbf.in	lbf.ft	A mm	L mm	kg
1÷27	0,1÷2,7	10÷240	3/8	70	253	0,52

592/3 € 704,00 1 005920005

Nm	Kgfm	lbf.in	lbf.ft	A mm	L mm	kg
3÷40	0,3÷4	20÷360	3/8	70	253	0,52

592/4 € 704,00 1 005920007

594

direct reading torque wrenches
for right-hand and left-hand tightening
torque accuracy: $\pm 4\%$

12"



UNI EN ISO 6789

Nm	Kgfm	lbf.ft	lbf.in	A mm	L mm	kg
6÷80	0,6÷8	5÷60	1/2	85	455	1,35

594/8 € 1.067,00 1 005940011

Nm	Kgfm	lbf.ft	lbf.in	A mm	L mm	kg
20÷215	2÷21,5	15÷160	1/2	85	530	1,40

594/21 € 1.067,00 1 005940015

Torque calibration
service
at end of price list

596 - 598

direct reading torque wrenches
for right-hand and left-hand tightening
torque accuracy: $\pm 4\%$

A signal light and an intermittent sound mean the pre-set torque load is achieved.



UNI EN ISO 6789

Nm	Kgfm	lbf.ft	□	A mm	L mm	kg
80÷400	8÷40	60÷300	3/4"	111	710	3,2

596/40SL 1.760,00 € 1 005960010

Nm	Kgfm	lbf.ft	□	A mm	L mm	kg
160÷800	16÷80	120÷600	3/4"	115	1025	4,85

596/80SL 2.220,00 € 1 005960020

Nm	Kgfm	lbf.ft	□	A mm	L mm	kg
200÷2000	20÷200	150÷1500	1"	135	1930	16,70

598/200SL 4.620,00 € 1 005980022

599DGT

electronic torque wrench
with reversible ratchet,
right-hand (accuracy: $\pm 2\%$) and left-hand
(accuracy: $\pm 3\%$) tightening

- Dual measurement mode: peak hold and track
- Light indicators and an intermittent sound inform user that preset torque has been reached
- Power supply: 2 1.5V batteries (included)



UNI EN ISO 6789

Nm	Kgfm	lbf.ft	□	D mm	A mm	L mm	kg
12÷60	1,2÷6	8÷44	3/8"	30	33	413	0,9

599DGT/6 375,00 € 1 005990003

Nm	Kgfm	lbf.ft	□	D mm	A mm	L mm	kg
20÷100	2÷10	15÷80	1/2"	30	37	413	0,9

599DGT/10X 386,00 € 1 005990010

Nm	Kgfm	lbf.ft	□	D mm	A mm	L mm	kg
40÷200	4÷20	30÷150	1/2"	40	43	520	2

599DGT/20 401,00 € 1 005990020

Nm	Kgfm	lbf.ft	□	D mm	A mm	L mm	kg
68÷340	6,8÷34	58÷280	1/2"	40	43	640	2,35

599DGT/30 432,00 € 1 005990030

599DGT-AN

electronic torque wrench, torque and angle
readout,
with reversible ratchet,
right-hand (accuracy: $\pm 2\%$)
and left-hand (accuracy: $\pm 3\%$) tightening

- tightening types: torque, angle, torque + angle
- dual measurement mode: peak hold and track
- light indicators and an intermittent sound inform user that preset torque or angle has been reached
- tightening data storage (up to 250 values)
- up to 9 torque/angle values can be preset
- key safety lockout
- wrench can be associated with 16 users through user ID
- tightening data traceability. Software allows date and time, tool serial number, set tightening value and reached value to be stored and associated with user ID
- nonslip bi-material handle
- included: 2 AA - 1.5V batteries, USB cable and software



UNI EN 26789
ISO 6789

Nm	Kgfm	lbf.ft	□	D mm	A mm	L mm	kg
20÷100	2÷10	15÷80	1/2"	30	33	413	0,9

599DGT-AN/10 704,00 € 1 005990610

Nm	Kgfm	lbf.ft	□	D mm	A mm	L mm	kg
40÷200	4÷20	30÷150	1/2"	40	43	520	1,3

599DGT-AN/20 743,00 € 1 005990620

**Torque calibration
service
at end of price list**

600

torque angle indicators

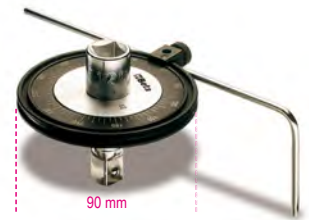

	□	■	€	1	006000001
600/1	1/2"	1/2"	150,00	1	006000001
600/2	3/4"	3/4"	170,00	1	006000002

601C

digital torque indicator

Light signals and an intermittent sound inform user
that preset angle has been reached



	€	1	006010100
601C	202,00	1	006010100

85x80x87 mm - 70 g

601CA

digital torque and angle indicator

light indicators and an intermittent sound
inform user that preset torque or angle
has been reached



	□	■	Nm	€	1	006010120
601CA	1/2"	1/2"	10÷200	357,00	1	006010120

120x90x120 mm - 240 g

603

calibrated slipping torque wrenches for right-hand tightening torque accuracy: $\pm 6\%$



UNI EN ISO 6789

Nm	Kgfm	lbf.in	A mm	L mm	g
1÷5	0,1÷0,5	10÷45	1/4	35	195

603/5 € 608,00 1 006030005

Nm	Kgfm	lbf.in	A mm	L mm	g
2÷10	0,2÷1,0	18÷90	1/4	35	195

603/10 € 622,00 1 006030010

604B

break-back torque bars for right-hand and left-hand tightening torque accuracy: $\pm 6\%$



UNI EN ISO 6789

Nm	kgfm	lbf.in	Ø mm	L mm	g
1÷5	0,1÷0,5	10÷45	8	220	290

604B/5 € 395,00 1 006040015

Nm	Kgfm	lbf.in	Ø mm	L mm	g
2÷10	0,2÷1,0	18÷90	8	220	300

604B/10 € 395,00 1 006040020

605E

click-type torque wrenches with reversible ratchets for right-hand and left-hand tightening torque accuracy: $\pm 6\%$



UNI EN ISO 6789

Nm	Kgfm	lbf.in	A mm	L mm	g
1÷5	0,1÷0,5	10÷45	1/4	20	190

605E/5 € 203,00 1 006050105

Nm	Kgfm	lbf.in	A mm	L mm	g
2÷10	0,2÷1,0	18÷90	1/4	20	190

605E/10 € 212,00 1 006050110

610/5

click-type torque wrenches with reversible ratchets, for right-hand tightening, with 5 preset values, torque accuracy: $\pm 4\%$

Selectable torque values: 90 - 100 - 110 - 120 - 130 Nm



UNI EN ISO 6789

Nm	D mm	A mm	L mm	g
90÷130	1/2	42	39	490

610/5 € 169,00 1 006100025

610L/5

click-type torque wrenches with L-shaped levers, for right-hand tightening, with 5 preset values, torque accuracy: $\pm 4\%$

Selectable torque values: 90 - 100 - 110 - 120 - 130 Nm



UNI EN ISO 6789

Nm	D mm	L mm	L1 mm	g
90÷130	1/2	470	80	1350

610L/5 € 150,00 1 006100125

611

reversible ratchets for torque bars items 604B/5 and 604B/10 8 mm drive



Drive	L mm	€	Qty	Part No.
1/4	42,5	142,00	1	006110001

Torque calibration service at end of price list

612 ÷ 614

reversible ratchets for torque bars



Items 612 and 612X should not be used with tightening torques exceeding 100 Nm

Item	Drive	L mm	LA mm	€	Qty	Part No.
612	3/8	66	32	64,00	2	006120000
612X	1/2	66	32	67,50	2	006120010
614	1/2	71	32	74,00	2	006140000
614X	3/4	71	32	80,50	2	006140004

614/50

push-through ratchet for torque bars



Item	Drive	L mm	LA mm	€	Qty	Part No.
614/50	1/2	71	32	67,50	2	006140002

Spare parts rotating mechanism of ratchets, see table after item 929/C8

615

reversible ratchets for torque bars, rectangular drive



Item	Drive	L mm	LA mm	€	Qty	Part No.
9x12	3/8	53	28,8	54,00	1	006150010
9x12	1/2	53	28,8	54,00	1	006150020
14x18	1/2	70	39,8	54,00	1	006150120

616 - 617 - 619

fixed heads for torque bars



Item	Drive	L mm	LA mm	€	Qty	Part No.
616	1/4	61	32	50,50	1	006160000
617	3/8	61	32	50,50	1	006170000
619	1/2	63	32	50,50	1	006190000

621

bit holder accessories
for torque bars, rectangular drive



	■ mm	○ mm	L mm	LA mm	€	🔧	📄
P 1/4	9x12	1/4	40	28,8	64,50	1	006210000
* P 5/16	14x18	5/16	61	32,5	98,50	1	006210110

*Caution! Recalculate torque value to set as shown in table at end of price list

622

reversible ratchets
for torque bars,
round drive, Ø 22 mm



	■ mm	L mm	LA mm	€	🔧	📄
622 3/4	3/4	110	56	179,50	1	006220019
622 1	1	110	56	218,00	1	006220024

641

open jaw wrenches
for torque bars 604B/5 and 604B/10
8 mm drive



🔧	L mm	€	🔧	📄
4	37	76,50	1	006410003
5	37	76,50	1	006410004
5,5	37	76,50	1	006410005
6	37	76,50	1	006410006
7	37	76,50	1	006410007
8	42	76,50	1	006410008
9	42	76,50	1	006410009
10	42	76,50	1	006410010

642

open jaw wrenches for torque bars



🔧	L mm	LA mm	A mm	€	🔧	📄
8	54	32	22	53,50	1	006420008
10	57	32	26	53,50	1	006420010
12	58	32	30	53,50	1	006420012
13	58	32	30	53,50	1	006420013
14	59	32	32	53,50	1	006420014
15	59	32	35	53,50	1	006420015
16	59	32	38	53,50	1	006420016
17	60	32	39	53,50	1	006420017
18	61	32	42	53,50	1	006420018
19	61	32	43	53,50	1	006420019
20	61	32	50	83,00	1	006420020
21	62	32	53	83,00	1	006420021
22	62	32	53	91,00	1	006420022
23	65	32	53	91,00	1	006420023
24	63	32	53	91,00	1	006420024
26	64	32	59	111,00	1	006420026
27	65	32	59	111,00	1	006420027
28	66	32	64	111,00	1	006420028
30	66	32	66	111,00	1	006420030
32	67	32	66	111,00	1	006420032
* 36	76	42	80	152,00	1	006420036
* 40	77	52	95	152,00	1	006420040
* 41	78	52	95	152,00	1	006420041
* 46	90	52	95	183,50	1	006420046

*Caution! Recalculate torque value to set as shown in table at end of price list

643

open jaw wrenches
for torque bars, rectangular drive

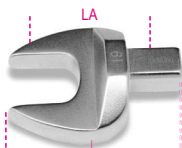

🔧	■ mm	L mm	LA mm	€	🔧	📄
7	9X12	37	28,8	47,50	1	006430007
8	9x12	37	28,8	47,50	1	006430008
10	9x12	39	28,8	47,50	1	006430010
12	9x12	39	28,8	47,50	1	006430012
13	9x12	39	28,8	47,50	1	006430013
14	9x12	43	28,8	48,00	1	006430014
15	9x12	43	28,8	48,00	1	006430015
16	9x12	43	28,8	48,00	1	006430016
17	9x12	43	28,8	48,00	1	006430017
* 18	9x12	47	36,3	48,00	1	006430018
* 19	9x12	51	36,3	48,00	1	006430019
* 21	9X12	52	36,3	75,00	1	006430021
* 22	9x12	52	36,3	75,00	1	006430022

*Caution! Recalculate torque value to set as shown in table at end of price list

🔧	■ mm	L mm	LA mm	€	🔧	📄
13	14x18	60	39,8	50,00	1	006430113
14	14x18	58	39,8	50,00	1	006430114
15	14x18	60	39,8	50,00	1	006430115
16	14x18	60	39,8	50,50	1	006430116
17	14x18	60	39,8	50,50	1	006430117
18	14x18	61	39,8	50,50	1	006430118
19	14x18	61	39,8	50,50	1	006430119
21	14x18	61	39,8	78,50	1	006430121
22	14x18	62	39,8	78,50	1	006430122
24	14x18	64	39,8	78,50	1	006430124
* 27	14x18	68	44,8	89,00	1	006430127
* 30	14x18	77	49,8	89,50	1	006430130
* 32	14x18	77	49,8	89,50	1	006430132
* 34	14x18	80	54,8	142,00	1	006430134
* 36	14x18	83	54,8	142,00	1	006430136
* 38	14X18	83	54,8	142,00	1	006430138
* 41	14x18	91	64,8	142,00	1	006430141

*Caution! Recalculate torque value to set as shown in table at end of price list

644

open jaw wrenches
for torque bars,
round drive, Ø 22 mm



🔧	L mm	LA mm	A mm	€	🔧	📄
22	91	56	52	91,00	1	006440022
24	91	56	52	91,00	1	006440024
27	94	56	64	111,00	1	006440027
30	94	56	64	111,00	1	006440030
32	97	56	75,5	111,00	1	006440032
34	97	56	75,5	111,00	1	006440034
36	97	56	75,5	152,00	1	006440036
41	103,5	56	94	152,00	1	006440041
46	115,5	56	94	183,50	1	006440046

650A

adjustable wrenches
for torque bars,
rectangular drive



A min-max mm	■ mm	L mm	LA mm	€	🔧	📄
* 5-27	9X12	93	74,3	87,00	1	006500027
* 5-30	9X12	106	85,3	87,00	1	006500030
* 5-30	14X18	115	89	89,00	1	006500130
* 10-41	14X18	127	100	92,00	1	006500141

*Caution! Recalculate torque value to set as shown in table at end of price list

Beta

Beta

Quality Tools

650H

hook wrenches
for torque bars,
rectangular drive



mm	mm	L mm	LA mm	€		
* 28-36	14x18	122	92	46,00	1	006500928
* 40-45	14x18	129	92	46,00	1	006500940
* 50-55	14x18	129	92	46,00	1	006500950
* 58-62	14x18	135	92	49,00	1	006500958
* 68-75	14x18	139	92	53,50	1	006500968
* 80-90	14x18	145	92	53,50	1	006500980

*Caution! Recalculate torque value to set as shown in table at end of price list

652

ring wrenches for torque bars



mm	L mm	LA mm	€		
8	58	32	57,50	1	006520008
10	58	32	57,50	1	006520010
12	58	32	57,50	1	006520012
13	58	32	57,50	1	006520013
14	58	32	57,50	1	006520014
15	62	32	57,50	1	006520015
16	63	32	57,50	1	006520016
17	64	32	57,50	1	006520017
18	65	32	57,50	1	006520018
19	65	32	57,50	1	006520019
21	67	32	86,50	1	006520021
22	68	32	92,00	1	006520022
24	69	32	110,00	1	006520024
26	71	32	123,50	1	006520026
27	71	32	123,50	1	006520027
30	73	32	123,50	1	006520030
32	74	32	123,50	1	006520032

653

ring wrenches
for torque bars, rectangular drive



mm	mm	L mm	LA mm	€		
7	9x12	40	28,8	51,00	1	006530007
8	9x12	40	28,8	51,00	1	006530008
10	9x12	43	28,8	51,00	1	006530010
12	9x12	44	28,8	51,00	1	006530012
13	9x12	44	28,8	51,00	1	006530013
14	9x12	45	28,8	51,00	1	006530014
15	9x12	46	28,8	51,00	1	006530015
16	9x12	47	28,8	51,50	1	006530016
17	9x12	47	28,8	51,50	1	006530017
18	9x12	48	28,8	51,50	1	006530018
19	9x12	49	28,8	51,50	1	006530019
21	9x12	51	28,8	53,50	1	006530021
22	9x12	51	28,8	53,50	1	006530022

mm	mm	L mm	LA mm	€		
13	14x18	61	39,8	56,00	1	006530113
14	14x18	61	39,8	56,00	1	006530114
15	14x18	62	39,8	56,00	1	006530115
16	14x18	63	39,8	56,50	1	006530116

*Caution! Recalculate torque value to set as shown in table at end of price list

mm	mm	L mm	LA mm	€		
17	14x18	64	39,8	56,50	1	006530117
18	14x18	64	39,8	56,50	1	006530118
19	14x18	66	39,8	56,50	1	006530119
21	14x18	66	39,8	82,00	1	006530121
22	14x18	67	39,8	82,00	1	006530122
24	14x18	69	39,8	102,00	1	006530124
* 27	14x18	76	44,8	102,00	1	006530127
* 30	14x18	77	44,8	102,00	1	006530130
* 32	14x18	79	44,8	102,00	1	006530132
* 34	14x18	80	44,8	145,00	1	006530134
* 36	14x18	80	44,8	145,00	1	006530136
* 38	14x18	90	49,8	148,00	1	006530138
* 41	14x18	90	49,8	148,00	1	006530141

*Caution! Recalculate torque value to set as shown in table at end of price list

654

ring wrenches
for torque bars,
round drive, Ø 22 mm



mm	L mm	LA mm	A mm	€		
22	98,5	56	38	92,00	1	006540022
24	98,5	56	38	110,00	1	006540024
27	102,8	56	46,5	123,50	1	006540027
30	102,8	56	46,5	123,50	1	006540030
32	106,5	56	55	123,50	1	006540032
34	106,5	56	55	123,50	1	006540034
36	106,5	56	55	160,50	1	006540036
41	115,5	56	72	160,50	1	006540041
46	115,5	56	72	174,50	1	006540046

659/15

adaptor with rectangular female (14x18 mm)
and male (9x12 mm) drives



L mm	mm	mm	LA mm	€		
* 56	14x18	9x12	39	74,50	1	006590815

*Caution! Recalculate torque value to set as shown in table at end of price list



Always apply torque loads evenly
and progressively to avoid breakage
and any possible injury.

659/16

adaptor with rectangular female (9x12 mm)
and male (14x18 mm) drives



L mm	mm	mm	LA mm	€		
* 52	9x12	14x18	31	63,00	1	006590816

*Caution! Recalculate torque value to set as shown in table at end of price list

Beta

665 MECHANICAL TORQUE WRENCH WITH DIGITAL READOUT

Torque wrench 665 matches the sturdiness and reliability of Beta's tried-and-test mechanism and established ratchet with quick readings and an accurate digital system.



RELIABILITY

Beta's sturdy ratchet results in smooth movements and a take-up angle of no more than 5°.

ACCURACY

±3% improved accuracy compared to standard requirements.

SMOOTHNESS

The click mechanism translates into lighter movements and improved accuracy.

DIGITAL READING

The torque value is easier to set and read.

LONG OPERATING LIFE

CALIBRATION

Multi-point calibration, to correct nonlinear spring behaviour, obtained with Beta's torque meters 682, without taking the wrench apart.

RAPIDITY

Quick, efficient torque adjustment.

QUICK, ACCURATE DIGITAL TORQUE ADJUSTMENT

665

mechanical torque wrench with digital setting and reversible ratchet, for right-hand tightening, torque accuracy ± 3%

- Auto power off after 10" when torque is set under minimum torque threshold
- Display will remain on with set torque value
- Torque setting to decimal digit
- Power supply: battery 1 3V (included)



UNI EN ISO 6789

Nm	■	D mm	A mm	L mm	g
10÷60	3/8	30	33	335	655
665/6					
				€ 225,00	1 006650006
Nm	■	D mm	A mm	L mm	g
20÷100	3/8	30	33	375	725
665/10					
				€ 226,50	1 006650010
Nm	■	D mm	A mm	L mm	g
20÷100	1/2	30	37	375	725
665/10X					
				€ 231,50	1 006650011
Nm	■	D mm	A mm	L mm	g
40÷200	1/2	40	43	470	995
665/20					
				€ 246,50	1 006650020
Nm	■	D mm	A mm	L mm	g
60÷330	1/2	40	43	590	1260
665/30					
				€ 280,00	1 006650030



665LB

mechanical torque wrench, digital readout, with reversible ratchet, for right-hand tightening, torque accuracy: $\pm 3\%$

- Unit of measurement: lbf.ft
- Torque is easy to set and read through value shown on display
- Display remains on with set torque value
- Torque reading to 0.1 mm
- Automatic switch-off after 30 sec. with torque setting under minimum threshold
- Power supply: 1 3V battery (included)



UNI EN ISO 6789

lbf.ft	mm	D	A	L	g
7÷45	3/8	30	33	335	655
665LB/6 € 225,00 1 006650106					

lbf.ft	mm	D	A	L	g
15÷75	3/8	30	33	375	725
665LB/10 € 226,50 1 006650110					

lbf.ft	mm	D	A	L	g
15÷75	1/2	30	37	375	725
665LB/10X € 231,50 1 006650111					

lbf.ft	mm	D	A	L	g
30÷150	1/2	40	43	470	995
665LB/20 € 246,50 1 006650120					

lbf.ft	mm	D	A	L	g
45÷240	1/2	40	43	590	1260
665LB/30 € 280,00 1 006650130					

665SW

calibration device

- Device allows calibration of wrenches item 665 with help of torque meters 680 and 682, without having to dismantle wrench.
- Calibration is performed on several points, to compensate for nonlinear behaviour of spring.
- Fitted with a micro USB port, for firmware updates.



665SW € 22,70 1 006650100

666N CLICK-TYPE TORQUE WRENCHES



17 meshing teeth allow excellent effort distribution



Scale increased for improved visibility and setting accuracy



Handle and lens materials resistant to all chemical substances used in automotive sector, industry and aviation



Extremely high torque adjustment speed
Red colour of o-ring indicates that wrench is unlocked and torque can be adjusted

666N

click-type torque wrenches with reversible ratchets, for right-hand tightening, torque accuracy: $\pm 3\%$



UNI EN ISO 6789

Nm	Kgfm	lbf.ft	mm	D	A	L	g
5÷25	0,5÷2,5	4÷18	1/4	25	29	220	300
666N/2 € 304,00 1 006660002							

Nm	Kgfm	lbf.ft	mm	D	A	L	g
5÷25	0,5÷2,5	4÷18	3/8	25	29	220	300
666N/2X € 310,00 1 006660003							

Nm	Kgfm	lbf.ft	mm	D	A	L	g
10÷50	1÷5	7÷37	3/8	30	33	325	660
666N/5 € 225,00 1 006660005							

Nm	Kgfm	lbf.ft	mm	D	A	L	g
20÷100	2÷10	15÷75	3/8	30	33	367	730
666N/10 € 226,50 1 006660010							

Nm	Kgfm	lbf.ft	mm	D	A	L	g
20÷100	2÷10	15÷75	1/2	30	37	367	800
666N/10X € 231,50 1 006660011							

Nm	Kgfm	lbf.ft	mm	D	A	L	g
40÷200	4÷20	30÷150	1/2	40	43	465	1010
666N/20 € 246,50 1 006660020							

Nm	Kgfm	lbf.ft	mm	D	A	L	g
60÷300	6÷30	50÷220	1/2	40	43	581	1380
666N/30 € 280,00 1 006660030							



666N LBF.IN

click-type torque wrenches with reversible ratchets, for right-hand tightening torque accuracy: $\pm 3\%$
• Scale in pounds force per inch



UNI EN ISO 6789

lbf.in	mm	D mm	A mm	L mm	g
90÷440	3/8	30	33	325	660

666N-LBF.IN/5 € 225,00 1 006660055

lbf.in	mm	D mm	A mm	L mm	g
200÷900	3/8	30	33	367	730

666N-LBF.IN/10 € 226,50 1 006660070

lbf.in	mm	D mm	A mm	L mm	g
200÷900	1/2	30	37	367	800

666N-LBF.IN/10X € 231,50 1 006660071

lbf.in	mm	D mm	A mm	L mm	g
400÷1800	1/2	40	43	465	1010

666N-LBF.IN/20 € 246,50 1 006660072

lbf.in	mm	D mm	A mm	L mm	g
500÷3000	1/2	40	43	581	1380

666N-LBF.IN/30 € 280,00 1 006660073

667N

click-type torque wrenches with push-through ratchets, for right-hand and left-hand tightening, torque accuracy: $\pm 3\%$



UNI EN ISO 6789

Nm	Kgfm	lbf.ft	mm	D mm	A mm	L mm	g
40÷200	4÷20	30÷150	1/2	40	43	465	1010

667N/20 € 241,50 1 006670020

Nm	Kgfm	lbf.ft	mm	D mm	A mm	L mm	g
60÷300	6÷30	50÷220	1/2	40	43	581	1380

667N/30 € 270,00 1 006670030

Nm	Kgfm	lbf.ft	mm	D mm	A mm	L mm	g
80÷400	8÷40	60÷295	3/4	50	50	687	2090

667N/40 € 649,00 1 006670040

Spare parts
rotating mechanism of ratchets,
see table after item 929/C8

668N

click-type torque bars, for right-hand and left-hand tightening, torque accuracy: $\pm 3\%$



UNI EN ISO 6789

Nm	Kgfm	lbf.ft	mm	L mm	LB mm	LS mm	g
5÷25	0,5÷2,5	4÷18	16	220	148	32	300

668N/2 € 226,50 1 006680002

Nm	Kgfm	lbf.ft	mm	L mm	LB mm	LS mm	g
10÷50	1÷5	7÷37	16	307	229	32	590

668N/5 € 222,00 1 006680005

Nm	Kgfm	lbf.ft	mm	L mm	LB mm	LS mm	g
20÷100	2÷10	15÷75	16	376	269	32	670

668N/10 € 226,50 1 006680010

Nm	Kgfm	lbf.ft	mm	L mm	LB mm	LS mm	g
40÷200	4÷20	30÷150	16	450	352,6	32	795

668N/20 € 246,50 1 006680020

Nm	Kgfm	lbf.ft	mm	L mm	LB mm	LS mm	g
60÷300	6÷30	50÷220	16	588	475,9	32	1230

668N/30 € 280,00 1 006680030

668RG

click-type torque bar, ungraduated for right-hand and left-hand tightening torque accuracy: $\pm 4\%$
(to be used with items 680 - 682)



UNI EN ISO 6789

Nm	Kgfm	lbf.ft	mm	L mm	g
8÷60	0,8÷6	6÷44	16	288	550

668RG/6 € 183,00 1 006680206

Nm	Kgfm	lbf.ft	mm	L mm	g
20÷100	2÷10	15÷80	16	315	600

668RG/10 € 188,00 1 006680210

Nm	Kgfm	lbf.ft	mm	L mm	g
40÷200	4÷20	30÷150	16	405	780

668RG/20 € 200,00 1 006680220

Nm	Kgfm	lbf.ft	mm	L mm	g
60÷300	6÷30	50÷220	16	645	1130

668RG/30 € 223,50 1 006680230

668RGC

click-type torque wrench, ungraduated, for right-hand tightening, torque accuracy: $\pm 4\%$
(for use with items 680/40 - 682)



UNI EN ISO 6789

Nm	Kgfm	lbf.in	mm	D mm	A mm	L mm	g
12÷60	1,2÷6	5÷45	3/8	30	33	295	600

668RGC/6 € 167,00 1 006680406

Nm	Kgfm	lbf.in	mm	D mm	A mm	L mm	g
20÷100	2÷10	15÷75	3/8	30	33	335	700

668RGC/10 € 174,50 1 006680410

Nm	Kgfm	lbf.in	mm	D mm	A mm	L mm	g
20÷100	2÷10	15÷75	1/2	40	43	342	700

668RGC/10X € 174,50 1 006680411

Nm	Kgfm	lbf.in	mm	D mm	A mm	L mm	g
40÷200	4÷20	30÷150	1/2	40	43	425	1000

668RGC/20 € 177,50 1 006680420



669N

click-type torque bars,
rectangular drive,
for right-hand and left-hand tightening,
torque accuracy: $\pm 3\%$



UNI EN ISO 6789

Nm	Kgfm	lbf.ft	□ mm	L mm	LB mm	LS mm	g
5÷25	0,5÷2,5	4÷18	9x12	215	140	28,8	300

669N/2	€ 323,00	1	006690202
--------	----------	---	-----------

Nm	Kgfm	lbf.ft	□ mm	L mm	LB mm	LS mm	g
10÷50	1÷5	7÷37	9x12	307	226,8	28,8	590

669N/5	€ 248,50	1	006690205
--------	----------	---	-----------

Nm	Kgfm	lbf.ft	□ mm	L mm	LB mm	LS mm	g
20÷100	2÷10	15÷75	9x12	376	266,8	28,8	670

669N/10	€ 267,00	1	006690210
---------	----------	---	-----------

Nm	Kgfm	lbf.ft	□ mm	L mm	LB mm	LS mm	g
40÷200	4÷20	30÷150	9x12	450	345,6	28,8	795

669N/20	€ 320,00	1	006690220
---------	----------	---	-----------

Nm	Kgfm	lbf.ft	□ mm	L mm	LB mm	LS mm	g
40÷200	4÷20	30÷150	14x18	450	351	39,8	795

669N/20X	€ 338,00	1	006690221
----------	----------	---	-----------

Nm	Kgfm	lbf.ft	□ mm	L mm	LB mm	LS mm	g
60÷300	6÷30	50÷220	14x18	588	468,5	39,8	1230

669N/30	€ 357,00	1	006690230
---------	----------	---	-----------

Nm	Kgfm	lbf.ft	□ mm	L mm	LB mm	LS mm	g
80÷400	8÷40	60÷295	14x18	664	563	39,8	2100

669N/40	€ 411,00	1	006690240
---------	----------	---	-----------

671B/C5

torque bar item 604B/5 and accessories

14" ø8



671B/C5	€ 904,00	1	006710001
---------	----------	---	-----------

604B/5	1÷5 Nm
611	1/4
641	5-6-7-8 mm
900	4-5-5,5-6-7-8-9-10 mm

270x120x45 mm - 1,3 kg

671B/C10

torque bar item 604B/10 and accessories

14" ø8



671B/C10	€ 904,00	1	006710002
----------	----------	---	-----------

604B/10	2÷10 Nm
611	1/4
641	6-7-8-10 mm
900	4-5-5,5-6-7-8-9-10 mm

270x120x45 mm - 1,4 kg

671N/C10

torque bar 668N/10
and accessories

38" ø16



671N/C10	€ 1.013,00	1	006710110
----------	------------	---	-----------

668N/10	100 Nm
612	■ 3/8
617	■ 3/8
642	10-13-14-17-19 mm
652	10-13-14-17-19 mm
910A	□ 3/8 8-10-11-13-14-17-19 mm
910/21	125 mm
910/22	250 mm

400x180x45 mm - 4,3 kg

671N/C20

torque bar 668N/20
and accessories

12" ø16



671N/C20	€ 1.072,00	1	006710120
----------	------------	---	-----------

668N/20	200 Nm
614	■ 1/2
619	■ 1/2
642	10-13-14-17-19 mm
652	10-13-14-17-19 mm
920A	□ 1/2 10-11-13-14-17-19-22 mm
920/20	75 mm
920/21	125 mm
920/22	255 mm

510x180x45 mm - 5,5 kg

671N/C30

torque bar 668N/30
and accessories

12" ø16



671N/C30	€ 1.014,00	1	006710130
----------	------------	---	-----------

668N/30	300 Nm
614	■ 1/2
619	■ 1/2
642	13-14-17-19 mm
652	13-14-17-19 mm
920A	□ 1/2 13-14-17-19-22-24-27 mm
920/20	75 mm
920/21	125 mm
920/22	255 mm

620x180x45 mm - 5,8 kg

Beta

Beta

674/C

click-type torque bars,
round drive Ø 22 mm,
for right-hand and left-hand tightening,
torque accuracy: ± 4%,
in case



UNI EN ISO 6789

Nm	Kgfm	lbf.ft	Ø mm	L mm	LB mm	LS mm	kg
100÷500	10÷50	80÷400	22	786	725	56	3,4

674/C50	749,00	1	006740005
----------------	---------------	---	-----------

Nm	Kgfm	lbf.ft	Ø mm	L mm	LB mm	LS mm	kg
160÷800	16÷80	120÷600	22	997	915	56	4,5

674/C80	793,00	1	006740008
----------------	---------------	---	-----------

Nm	Kgfm	lbf.ft	Ø mm	L mm	LB mm	LS mm	kg
200÷1000	20÷100	150÷750	22	997	915	56	4,5

674/C100	804,00	1	006740010
-----------------	---------------	---	-----------

677

break-back torque wrenches
with push-through ratchets
for right-hand and left-hand tightening
torque accuracy: ±4%



UNI EN ISO 6789

Nm	Kgfm	lbf.ft	D mm	A mm	L mm	kg
100÷500	10÷50	70÷350	70	55	915	5,2

677/50	758,00	1	006770050
---------------	---------------	---	-----------

Nm	Kgfm	lbf.ft	D mm	A mm	L mm	kg
150÷700	15÷70	100÷500	70	55	1140	6,2

677/70	794,00	1	006770070
---------------	---------------	---	-----------

Nm	Kgfm	lbf.ft	D mm	A mm	L mm	kg
300÷1000	30÷100	200÷750	70	55	1470	7,5

677/100	826,00	1	006770100
----------------	---------------	---	-----------

677/C

break-back torque wrenches
with push-through ratchets,
for right-hand and left-hand tightening,
torque accuracy: ±4%

in case



UNI EN ISO 6789

Nm	Kgfm	lbf.ft	D mm	A mm	L mm	kg
100÷500	10÷50	70÷350	70	55	915	5,2

677/C50	897,00	1	006770606
----------------	---------------	---	-----------

Nm	Kgfm	lbf.ft	D mm	A mm	L mm	kg
150÷700	15÷70	100÷500	70	55	1140	6,2

677/C70	933,00	1	006770611
----------------	---------------	---	-----------

Nm	Kgfm	lbf.ft	D mm	A mm	L mm	kg
300÷1000	30÷100	200÷750	70	55	1470	7,5

677/C100	1.093,00	1	006770615
-----------------	-----------------	---	-----------

Nm	Kgfm	lbf.ft	D mm	A mm	L mm	kg
700÷1500	70÷150	500÷1000	70	70	1475	10,4

677/C150	1.400,00	1	006770620
-----------------	-----------------	---	-----------

677/CP200

break-back torque wrenches
with push-through ratchets,
for right-hand and left-hand tightening,
torque accuracy: ± 4%
in case



UNI EN ISO 6789

Nm	kgfm	lbf.ft	D mm	A mm	L mm	kg
900÷2000	90÷200	600÷1500	70	63	1920	13

677/CP200	2.560,00	1	006770720
------------------	-----------------	---	-----------

678/C

click-type torque wrenches
with push-through ratchets
for right-hand and left-hand tightening,
torque accuracy: ± 4%
in case

• Models 678/C100 and 678/C150 supplied complete with extensions.

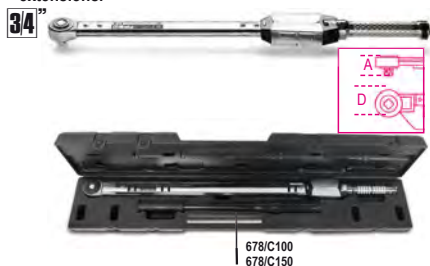

UNI EN ISO 6789

Nm	Kgfm	lbf.ft	D mm	A mm	L mm	kg
130÷650	13÷65	100÷480	63	55	885	3,9

678/C65	1.515,00	1	006780607
----------------	-----------------	---	-----------

Nm	Kgfm	lbf.ft	D mm	A mm	L mm	kg
300÷1000	30÷100	220÷750	75	60	1250	6,0

678/C100	2.020,00	1	006780611
-----------------	-----------------	---	-----------

Nm	Kgfm	lbf.ft	D mm	A mm	L mm	kg
500÷1500	50÷150	370÷1100	75	60	1570	8,5

678/C150	2.235,00	1	006780615
-----------------	-----------------	---	-----------

677/CV - 678/CV

empty cases for torque wrenches
items 677 and 678



677/CV1	139,50	1	006770450
----------------	---------------	---	-----------

678/CV1	107,50	1	006780455
----------------	---------------	---	-----------

678/CV2	130,50	1	006780500
----------------	---------------	---	-----------

678/CV3	267,00	1	006780415
----------------	---------------	---	-----------

677/C100-677/C150-678/C150

680

electronic digital torque meter
Dynatester 680
for checking calibration,
can be used both clockwise and anticlockwise

- Accuracy: $\pm 1\%$
- 3 measuring units: Nm - lbf.ft. - lbf.in

CE



	Nm	kg	€		
680/2,5	1÷25	2,6	1.990,00	1	006800002
680/40	15÷400	4,0	2.000,00	1	006800040
680/100	100÷1000	4,8	2.870,00	1	006800100

682

electronic digital torque meter
with transducer Dynatester 682
to be used either clockwise
or anticlockwise
Remarkable reading accuracy
Supplied with serial output RS 232
for printers

CE



TECHNICAL FEATU

Reading accuracy
 $\pm 1\%$ of the read val...
Available measuring units
Nm-dNm-cNm-lbf.ft-lbf.in-Ozf.in-Kgf.m-Kgf.cm-gf.cm
Supply range
90 to 264 V AC at 50/60 Hz
Dimensions 235x185x185 mm
Tolerance test according to norm ISO 6789
Acceptability range
for each torque wrench tested
Display
Menu available in 11 languages
Provided with all certificates required
Calibration certificate with UKAS traceability

	Nm	kg	€		
682/60	1,2÷60	5,9	5.370,00	1	006820006
682/400	8÷400	6,1	5.450,00	1	006820040
682/1500	30÷1500	6,4	5.620,00	1	006820150

IMPACT SOCKETS



Impact sockets are oversized compared to hand sockets, so that they can absorb high torque as developed by impact wrenches and torque multipliers.

The **hexagon profile** provides increased durability following intensive use. They must be used with pins and grommets to prevent disengagement from the drive.

As well as the classic models in standard and long versions, a long, slim series is also available, for use in spaces where screws cannot be accessed with standard models.

However, based on their significantly lower strength, caution is required when using them.



710

impact sockets, standard series



UNI/ISO 2725 DIN 3129

mm	Ø mm	L mm	Ø1 mm	€		
7	12,5	28	19	8,00	3	007100007
8	13,8	28	19	8,00	3	007100008
9	15,0	28	19	8,00	3	007100009
10	16,3	28	19	8,00	3	007100010
11	17,5	30	19	8,00	3	007100011
12	19,0	30	19	8,00	3	007100012
13	20,0	30	22	8,45	3	007100013
14	21,3	30	22	8,45	3	007100014
16	23,8	30	22	8,55	3	007100016
17	25,0	30	22	8,55	3	007100017
18	26,3	30	22	8,80	3	007100018
19	27,5	30	22	8,80	3	007100019
21	30,0	32	22	9,70	3	007100021
22	32,0	32	22	10,80	3	007100022

710/C10

10 impact sockets



	€		
710/C10 7-8-10-11-12-13 14-17-19-22 mm	106,00	1	007100910

130x55x40 mm - 800 g

710/16

impact adaptor, 3/8" female
and 1/2" male drives



L mm	Ø mm	□	1/2	€		
32	22	3/8	1/2	21,70	3	007100810

710/20

3/8" drive impact extension bar



L mm	Ø mm	€		
75	22	22,20	2	007100821

710/21

3/8" drive impact extension bar



L mm	Ø mm	€	🔧	📦
125	22	24,30	2	007100823

710/25

3/8" drive impact universal joint



L mm	Ø mm	€	🔧	📦
58	24	45,00	2	007100830

710/OR... - 710/SP...

rubber O-rings and locking pins for impact sockets



	710 mm	710/16 L mm	€	🔧	📦
710/OR1	7+12		0,67	10	007100921
710/OR2	13+22	32	0,67	10	007100922
710/SP1	7+12		1,23	10	007100911
710/SP2	13+22	32	1,23	10	007100912

720

impact sockets, standard series



UNI/ISO 2725 DIN 3129

mm	Ø mm	L mm	Ø1 mm	€	🔧	📦
8	15,0	38	25	9,85	5	007200008
9	16,0	38	25	9,85	5	007200009
10	17,0	38	25	9,95	5	007200010
11	18,5	38	25	9,95	5	007200011
12	20,0	38	25	9,95	5	007200012
13	21,0	38	25	9,95	5	007200013
14	22,5	38	25	9,95	5	007200014
15	23,0	38	30	11,20	5	007200015
16	25,0	38	30	11,20	5	007200016
17	26,0	38	30	11,20	5	007200017
18	27,5	38	30	11,20	5	007200018
19	28,5	38	30	11,20	5	007200019
21	31,0	38	30	12,30	5	007200021
22	32,5	38	30	12,50	5	007200022
23	34,0	38	30	13,60	5	007200023
24	35,0	38	30	13,60	5	007200024
27	38,5	45	30	15,90	3	007200027
30	42,0	50	30	17,30	3	007200030
32	44,0	50	30	19,90	3	007200032
36	50,0	50	30	28,50	3	007200036

720/C6

6 impact sockets



720/C6	€	🔧	📦
13-14-17-19-22-24 mm	91,50	1	007200910

195x80x55 mm - 1100 g

720/C12

12 impact sockets



720/C12	€	🔧	📦
10-11-12-13-14-17-19-22-24-27-30-32 mm	174,50	1	007200912

195x80x55 mm - 2000 g

720/C24

24 impact sockets



720/C24	€	🔧	📦
	392,00	1	007200904

720	10 - 12 - 13 - 14 - 15 - 16 - 17 - 18 - 19 - 21 - 22 - 24 - 27 - 30 - 32 mm
720L	13 - 17 - 19 - 21 - 22 - 24 mm
720LC	17 - 19 - 21 mm

420x185x60 mm - 6,2 kg

720MC

impact sockets, standard series, coloured



mm	Ø mm	L mm	€	🔧	📦
10	17,0	38	10,40	3	007202010
11	18,5	38	10,40	3	007202011
12	20,0	38	10,40	3	007202012
13	21,0	38	10,40	3	007202013
14	22,5	38	10,40	3	007202014
15	23,0	38	11,70	3	007202015
16	25,0	38	11,70	3	007202016
17	26,0	38	11,70	3	007202017
18	27,5	38	11,70	3	007202018
19	28,5	38	11,70	3	007202019
21	31,0	38	12,90	2	007202021
22	32,5	38	12,90	2	007202022
24	35,0	38	14,20	2	007202024

720MC/C13

13 impact sockets, coloured



720MC/C13	€	🔧	📦
10-11-12-13-14-15-16-17-18-19-21-22-24 mm	186,50	1	007202913

335x145x60 mm - 2,4 kg

720AS

impact sockets, standard series



mm	Ø mm	L mm	Ø1 mm	€	🔧	📦
3/8	17,0	38	25	16,20	2	007200210
7/16	18,2	38	25	16,20	2	007200211
1/2	20,7	38	25	16,20	2	007200213
9/16	22,0	38	25	16,20	2	007200214
5/8	24,5	38	30	17,30	2	007200216
11/16	25,7	38	30	17,30	2	007200217
3/4	28,2	38	30	17,30	2	007200219
13/16	30,7	38	30	18,40	2	007200221
7/8	32,0	38	30	18,40	2	007200222
15/16	34,5	38	30	19,60	2	007200224
1	35,7	38	30	21,10	2	007200225
1.1/16	38,2	40	30	23,40	1	007200227
1.1/8	40,7	42	30	26,00	1	007200229
1.1/4	44,5	42	30	29,00	1	007200232

720S

impact sockets,
compact series



Ø mm	Ø mm	L mm	Ø1 mm	€	🔧	📦
13	20,0	28,0	23,8	6,25	3	007200113
15	23,0	28,0	23,8	6,25	3	007200115
17	25,8	28,0	25,8	6,80	3	007200117
19	27,8	28,0	27,8	7,45	3	007200119
22	31,8	28,0	30,0	8,10	3	007200122
24	33,8	28,0	30,0	8,80	3	007200124



720S/SB6 € 52,00 1 007200906
13-15-17-19-22-24 mm

720L

impact sockets, long series



UNI/ISO 2725

Ø mm	Ø mm	L mm	Ø1 mm	€	🔧	📦
10	17,0	80	25	17,00	2	007200310
11	18,5	80	25	17,00	2	007200311
12	20,0	80	25	17,00	2	007200312
13	21,0	80	25	17,00	2	007200313
14	22,5	80	25	17,00	2	007200314
15	23,0	80	30	19,40	2	007200315
16	25,0	80	30	19,40	2	007200316
17	26,0	80	30	19,40	2	007200317
18	27,5	80	30	20,60	2	007200318
19	28,5	80	30	20,60	2	007200319
21	31,0	80	30	21,70	2	007200321
22	32,5	80	30	21,70	2	007200322
24	35,0	80	30	22,80	2	007200324
27	38,5	80	30	28,50	2	007200327
30	42,0	80	30	35,00	2	007200330
32	44,0	80	30	35,00	2	007200332
36	50,0	80	30	44,50	2	007200336

720L/S3

set of 3 impact sockets item 720L



720L/S3 € 61,50 1 007200355
17-19-21 mm

720LS

impact sockets,
long, slim series



UNI/ISO 2725

Ø mm	Ø mm	L mm	Ø1 mm	€	🔧	📦
10	15,5	78	24	18,40	2	007200360
11	16,7	78	24	18,40	2	007200361
12	18,0	78	24	18,40	2	007200362
13	19,2	78	24	18,40	2	007200363
14	20,5	78	24	18,40	2	007200364
15	21,7	78	24	18,90	2	007200365
16	23,0	78	24	18,90	2	007200366
17	24,2	78	29	21,10	2	007200367
18	25,5	78	29	22,80	2	007200368
19	26,7	78	29	22,80	2	007200369
21	29,2	78	29	23,90	2	007200371
22	30,5	78	29	23,90	2	007200372
24	33,0	78	29	24,50	2	007200374
27	36,7	78	29	30,00	2	007200377
30	40,5	78	29	37,50	2	007200380
32	43,0	78	29	39,00	2	007200382
36	48,0	78	29	59,00	2	007200386

720LC

wheel nut impact sockets,
with coloured polymeric inserts



Ø mm	Ø mm	€	🔧	📦
17	26,5	12,30	2	007200637
19	28,5	12,30	2	007200639
21	30,3	12,80	2	007200641
22	32,4	13,30	2	007200642
24	34,6	14,50	2	007200644



720LC/C3 € 37,50 1 007200653
17-19-21 mm
148x132x44 mm - 860 g



720LC/S5 € 65,00 1 007200645
17-19-21-22-24 mm



720LC/PM5 € 102,00 1 007200646
17-19-21-22-24 mm

PM 1/2-Q5

magnetic socket rail



PM 1/2-Q5 € 37,00 1 088880233

720IC

spare coloured polymeric inserts for impact sockets 720LC-720LCL



720IC	Ø mm	€	🔧	📦
17	17	4,95	1	007200687
19	19	4,95	1	007200689
21	21	4,95	1	007200691
22	22	4,95	1	007200692
24	24	4,95	1	007200694

720LCL

wheel nut impact sockets
with coloured polymeric inserts,
long series



Ø mm	Ø mm	€	🔧	📦
17	26,5	20,40	1	007200737
19	28,5	20,40	1	007200739
21	30,3	20,40	1	007200741



720LCL/C3 € 78,00 1 007200753
17-19-21 mm
210x50x150 mm - 1,65 kg

720MRC

impact socket
with polymeric insert for Mercedes wheel
screw



mm	Ø	L	□	€	🔧	📦
17	27	85	1/2	18,90	1	007200631

720TC

impact torsion bars, coloured,
for motor vehicle wheel nuts,
with 1/2" male and female square drives



Nm	L	€	🔧	📦
90	200	20,50	1	007200769
100	200	20,50	1	007200770
110	200	20,50	1	007200771
120	200	20,50	1	007200772
135	200	20,50	1	007200773



€	🔧	📦
102,50	1	007200779

90-100-110-120-135 Nm
260x50x175 mm - 1,35 kg

720FTX

impact sockets, for Torx® head screws



Ø	L	Ø1	€	🔧	📦
E10	14,0	38	25	16,00	2 007200410
E12	15,9	38	25	16,00	2 007200412
E14	17,7	38	25	16,00	2 007200414
E16	20,0	38	25	16,00	2 007200416
E18	22,0	38	25	16,00	2 007200418
E20	25,0	40	25	16,90	2 007200420
E24	30,0	40	30	16,90	2 007200424



€	🔧	📦
105,50	1	007200450

720FTX/SB6
E10-E12-E14
E16-E18-E20

720TX

impact socket drivers for Torx® head screws



Ø	L	L1	€	🔧	📦
T30	25	78	54	14,00	3 007200460
T40	25	78	54	14,00	3 007200470
T45	25	78	54	14,30	3 007200472
T50	25	78	54	14,30	3 007200474
T55	25	78	54	16,20	3 007200476
T60	25	78	54	17,30	3 007200478

720TX/C6

6 impact socket drivers for Torx® head screws



€	🔧	📦
118,50	1	007200483

720TX/C6
T30-T40-T45
T50-T55-T60

275x120x65 mm - 5700 g

720ME

impact socket drivers for hexagon screws



Ø	L	L1	€	🔧	📦
5	25	78	54	13,40	3 007200505
6	25	78	54	13,40	3 007200506
8	25	78	54	13,40	3 007200508
10	25	78	54	13,40	3 007200510
12	25	78	54	13,40	3 007200512
14	25	78	54	15,00	3 007200514
17	25	78	54	15,00	3 007200517
19	25	78	54	15,00	3 007200519

720ME/C8

8 impact socket drivers
for hexagon screws



€	🔧	📦
143,00	1	007200525

720ME/C8
5-6-8-10-12
14-17-19 mm

270x120x45 mm - 1710 g

720/15

impact adaptor, 1/2" female
and 3/8" male drives



L	Ø	□	■	€	🔧	📦
37,5	25	1/2	3/8	11,20	3	007200810

Always apply torque loads evenly
and progressively to avoid breakage
and any possible injury.

720/16

impact adaptor, 1/2" female
and 3/4" male drives



L	Ø	□	■	€	🔧	📦
44	30	1/2	3/4	19,30	3	007200814

720/20

1/2" drive impact extension bar



L	Ø	€	🔧	📦
75	25	19,90	3	007200818

720/21

1/2" drive impact extension bar



L	Ø	€	🔧	📦
125	25	21,50	3	007200822

720/25

1/2" drive impact universal joint



L	Ø	€	🔧	📦
64	28	36,50	2	007200831

720/OR... - 720/SP...

rubber O-rings and locking pins for impact sockets

12"

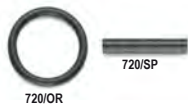

	720	720TX			
	mm	T30+T60	€		
720/OR1	10+14	T30+T60	1,28	10	007200923
720/OR2	15+32		1,28	10	007200924
720/SP1	10+14	T30+T60	1,89	10	007200913
720/SP2	15+32		1,89	10	007200914

727PI/16

impact bit holder for item 727/ES16 and 727/ES16TX



ø	L	□	€		
mm	mm	mm			
44	52	16	43,50	2	007270016

727/ES16

impact hexagon bits, 16 mm drive



mm	ø	L	€		
mm	mm	mm			
10	16	40	14,70	2	007270110
12	16	40	14,70	2	007270112
13	16	40	14,70	2	007270113
14	16	40	14,70	2	007270114
16	16	40	15,80	2	007270116
17	16	40	15,80	2	007270117
18	16	40	16,50	2	007270118
19	16	40	16,50	2	007270119
22	16	40	18,90	2	007270122

727/ES16TX

impact bits for Torx® head screws, 16 mm drive



ø	mm	L	€		
mm	mm	mm			
T55	16	50	22,10	2	007270355
T60	16	50	22,10	2	007270360
T70	16	50	22,10	2	007270370

727PI/22

impact bit holder for item 727/ES22 and 727/ES22TX



ø	L	□	€		
mm	mm	mm			
54	70	22	67,00	2	007270022

727/ES22

impact hexagon bits, 22 mm drive



mm	ø	L	€		
mm	mm	mm			
19	22	50	18,90	2	007270219
22	22	50	18,90	2	007270222
24	22	50	20,90	2	007270224
27	22	50	23,40	2	007270227
30	22	50	28,00	2	007270230
32	22	50	30,50	2	007270232

727/ES22TX

impact bits for Torx® head screws, 22 mm drive



ø	mm	L	€		
mm	mm	mm			
T80	22	60	31,00	2	007270480
T90	22	60	31,00	2	007270490
T100	22	60	31,00	2	007270500

727/C16

12 impact bits and 4 accessories



727/C16	€		
	421,00	1	007270900

727PI/16

727/ES16 14-17-19 mm

727/ES16TX T55-T60-T70

727PI/22

727/ES22 22-24-27 mm

727/ES22TX T80-T90-T100

96BPC 3-4 mm

335x145x60 mm - 3,6 kg

727PI/32

impact bit holder for item 727/ES32

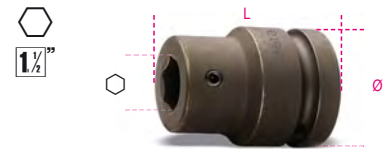

ø	L	□	€		
mm	mm	mm			
86	66	32	167,00	1	007270032

727/ES32

impact hexagon bit, 32 mm drive



mm	ø	L	€		
mm	mm	mm			
19	32	44	43,00	2	007270519
22	32	44	43,00	2	007270522
24	32	44	43,00	2	007270524
27	32	44	43,00	2	007270527
30	32	44	43,00	2	007270530
32	32	44	43,00	2	007270532
36	32	44	48,00	2	007270536

728

impact sockets, standard series



UNI/ISO 2725 DIN 3129

ø	mm	L	ø1	€	
mm	mm	mm	mm		
17	30,0	51	44	24,30	2 007280017
18	31,0	51	44	24,30	2 007280018
19	32,5	51	44	24,30	2 007280019
21	35,0	51	44	24,30	2 007280021
22	36,0	51	44	24,30	2 007280022
23	37,5	51	44	24,80	2 007280023
24	38,5	51	44	24,80	2 007280024
27	42,5	53	44	24,80	2 007280027
28	44,0	53	44	25,50	2 007280028
30	46,0	53	44	26,00	2 007280030
32	48,5	57	44	27,50	2 007280032
33	50,0	57	44	29,50	2 007280033
34	51,0	57	44	29,50	2 007280034
35	52,5	57	44	30,00	2 007280035
36	53,5	57	44	31,00	2 007280036
38	56,0	57	44	35,00	1 007280038
40	58,5	58	44	37,00	1 007280040
41	60,0	58	44	37,50	1 007280041
44	64,0	62	44	41,00	1 007280044
45	65,0	62	44	44,00	1 007280045
46	66,0	62	44	44,50	1 007280046
50	71,0	68	54	52,50	1 007280050
55	77,5	71	54	58,00	1 007280055
60	83,0	73	54	66,00	1 007280060
65	88,0	78	54	74,00	1 007280065

728/C10

10 impact sockets

3/4"



728/C10	€ 317,00	1	007280910
17-19-22-24-27-30			
32-36-41-46 mm			

275x120x65 mm - 5,7 kg

728AS

impact sockets, standard series

3/4"



"	Ø mm	L mm	Ø1 mm	€	U	IT
3/4	32,0	51	41	24,50	1	007280219
13/16	35,0	51	41	25,00	1	007280221
7/8	36,0	51	41	25,00	1	007280222
15/16	38,5	51	41	25,00	1	007280224
1	40,0	53	41	25,50	1	007280225
1.1/16	42,5	53	44	27,00	1	007280227
1.1/8	44,0	53	44	27,50	1	007280230
1.1/4	48,5	57	44	28,00	1	007280232
1.5/16	50,0	57	44	29,50	1	007280233
1.7/16	53,5	57	44	31,00	1	007280236
1.1/2	56,0	57	44	34,50	1	007280238
1.5/8	60,0	58	44	37,50	1	007280241

728FTX

impact sockets, for Torx® head screws

3/4"



Ø mm	L mm	Ø1 mm	€	U	IT	
E20	28,5	50	44	32,50	2	007280420
E22	30,0	50	44	32,50	2	007280422
E24	32,5	50	44	32,50	2	007280424

728L

impact sockets, long series

3/4"



"	Ø mm	L mm	Ø1 mm	€	U	IT
19	32,5	90	44	38,50	2	007280319
21	35,0	90	44	38,50	2	007280321
22	36,0	90	44	38,50	2	007280322
24	38,5	90	44	38,50	2	007280324
26	41,0	90	44	38,50	2	007280326
27	42,5	90	44	38,50	2	007280327
30	46,0	90	44	40,00	2	007280330

"	Ø mm	L mm	Ø1 mm	€	U	IT
32	48,5	90	44	42,00	2	007280332
33	50,0	90	44	45,00	1	007280333
34	51,0	90	44	47,50	1	007280334
36	53,5	90	44	49,50	1	007280336
38	56,0	90	44	57,50	1	007280338
41	60,0	90	44	59,00	1	007280341
44	64,0	90	44	67,50	1	007280344
46	66,0	90	44	67,50	1	007280346
50	71,0	90	44	81,00	1	007280350
55	77,5	100	54	106,50	1	007280355

3/4"



728L/S3	€ 131,50	1	007280393
30-32-36 mm			

728LS

impact sockets, long slim series

3/4"



"	Ø mm	L mm	Ø1 mm	€	U	IT
17	28,0	100	43	43,50	2	007280517
19	30,5	100	43	43,50	2	007280519
22	34,3	100	43	44,50	2	007280522
24	36,8	100	43	44,50	2	007280524
27	40,5	100	43	44,50	2	007280527
30	44,3	100	43	44,50	2	007280530
32	46,8	100	43	47,50	2	007280532
33	48,0	100	43	49,00	2	007280533
36	51,8	100	43	57,00	1	007280536

728LQ

impact sockets, long series

(for ISUZU wheel nuts)

3/4"



"	L mm	Ø mm	Ø1 mm	€	U	IT
19	90	35	43,5	39,00	1	007280619
21	90	42	43,5	39,00	1	007280621

728/15

impact adaptor, 3/4" female and 1/2" male drives

3/4"



"	L mm	Ø mm	□	■	€	U	IT
58	38	3/4	1/2		30,00	2	007280810



Always apply torque loads evenly and progressively to avoid breakage and any possible injury.

728/16

impact adaptor, 3/4" female and 1" male drives

3/4"



"	L mm	Ø mm	□	■	€	U	IT
62	62	44	3/4	1	36,50	2	007280813

728/21

3/4" drive impact extension bar

3/4"



"	L mm	Ø mm	€	U	IT
175	175	44	45,00	2	007280815

728/22

3/4" drive impact extension bar

3/4"



"	L mm	Ø mm	€	U	IT
250	250	44	52,00	2	007280825

728/22L

3/4" drive impact extension bar

3/4"



"	L mm	Ø mm	€	U	IT
330	330	44	66,00	1	007280826

728/25

3/4" drive impact universal joint

3/4"



"	L mm	Ø mm	€	U	IT
107,5	107,5	44	87,50	1	007280830

728/OR - 728/SP

rubber O-rings and locking pins for impact sockets

3/4"



"	728 mm	728FTX	€	U	IT
728/OR	728/15		1,84	5	007280925
728/OR	17+46	E20+E24	1,96	10	007280926
728/SP	17+46	E20+E24	2,57	10	007280916

729

impact sockets, standard series



UNI/ISO 2725 DIN 3129

Ø mm	Ø mm	L mm	Ø1 mm	€	Hand	Computer
24	41,5	58	54	39,00	1	007290024
27	45,0	60	54	39,00	1	007290027
30	49,0	62	54	39,00	1	007290030
32	51,5	63	54	40,00	1	007290032
33	52,5	63	54	40,00	1	007290033
34	54,0	63	54	40,00	1	007290034
36	56,5	66	54	40,00	1	007290036
38	59,0	66	54	48,00	1	007290038
41	62,5	68	54	49,00	1	007290041
46	69,0	72	54	55,00	1	007290046
50	74,0	76	54	67,50	1	007290050
55	80,0	84	54	72,50	1	007290055
60	86,5	88	54	87,50	1	007290060
65	92,5	92	54	100,50	1	007290065
70	99,0	96	54	128,50	1	007290070
75	105,0	102	63	150,00	1	007290075
80	111,5	102	63	161,50	1	007290080

729L

impact sockets, long series



Ø mm	Ø mm	L mm	Ø1 mm	€	Hand	Computer
24	41,5	108	54	69,00	1	007290324
27	45,0	108	54	69,00	1	007290327
30	49,0	108	54	69,00	1	007290330
32	51,5	108	54	69,00	1	007290332
33	52,2	108	54	70,00	1	007290333
34	54,0	108	54	70,00	1	007290334
36	56,5	108	54	70,00	1	007290336
41	62,5	108	54	83,50	1	007290341
46	69,0	108	54	96,50	1	007290346
50	74,0	108	54	108,00	1	007290350
55	80,0	108	54	129,50	1	007290355
60	86,5	108	54	140,00	1	007290360
65	92,5	108	54	169,00	1	007290365
70	99,0	108	54	192,50	1	007290370
75	105,0	108	63	217,00	1	007290375
80	111,5	108	63	228,00	1	007290380

729LS

impact sockets, long slim series



Ø mm	Ø mm	L mm	Ø1 mm	€	Hand	Computer
22	36,0	108	53	69,00	1	007290522
24	38,5	108	53	69,00	1	007290524
27	46,0	108	53	69,00	1	007290527
30	50,0	108	53	73,50	1	007290530
32	50,0	108	53	73,50	1	007290532
33	52,0	108	53	73,50	1	007290533
36	56,0	108	53	73,50	1	007290536

729T

impact torsion bars for wheel nuts



Ø mm	Nm	L mm	€	Hand	Computer
24	350	300	130,50	1	007290724
27	450	300	130,50	1	007290757
30	500	300	132,00	1	007290730
32	450	300	134,00	1	007290732
32	600	300	134,00	1	007290762
33	600	300	140,50	1	007290763
36	600	300	149,00	1	007290736

729/15

impact adaptor, 1" female and 3/4" male drives



Always apply torque loads evenly and progressively to avoid breakage and any possible injury.

L mm	Ø mm	1	3/4	€	Hand	Computer
66,5	54	1	3/4	47,00	1	007290810

729/16

impact adaptor, 1" female and 1.1/2" male drives



L mm	Ø mm	1	1.1/2	€	Hand	Computer
88	54,0	1	1.1/2	77,50	1	007290813

729/21

1" drive impact extension bar



L mm	Ø mm	€	Hand	Computer
175	54	72,50	1	007290815

729/22

1" drive impact extension bar



L mm	Ø mm	€	Hand	Computer
330	54	104,00	1	007290825

729/25

1" drive impact universal joint



L mm	Ø mm	€	Hand	Computer
130	54	150,00	1	007290830

729/OR... - 729/SP...

rubber O-rings and locking pins for impact sockets

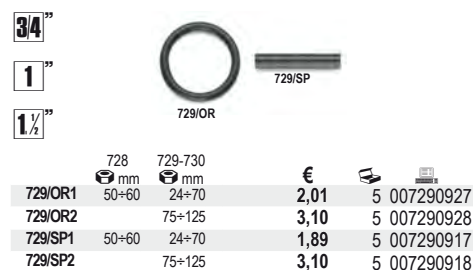

729/OR1	728 mm	729-730 mm	€	Hand	Computer
729/OR1	50+60	24+70	2,01	5	007290927
729/OR2	75+125	24+70	3,10	5	007290928
729/SP1	50+60	24+70	1,89	5	007290917
729/SP2	75+125	24+70	3,10	5	007290918

730

impact sockets, standard series



UNI/ISO 2725 DIN 3129

Ø mm	Ø mm	L mm	Ø1 mm	€	Hand	Computer
50	81	87	84	206,00	1	007300050
55	88	90	86	211,50	1	007300055
60	94	95	86	234,00	1	007300060
65	100	100	86	256,00	1	007300065
70	106	105	86	303,00	1	007300070
75	113	110	86	351,00	1	007300075
80	119	115	86	402,00	1	007300080
85	125	120	86	445,00	1	007300085
90	132	125	86	506,00	1	007300090
95	138	125	96	590,00	1	007300095
100	144	130	96	685,00	1	007300100
105	150	135	96	763,00	1	007300105
110	157	140	96	830,00	1	007300110
115	163	140	96	891,00	1	007300115
120	169	145	96	997,00	1	007300120
125	175	145	96	1.041,00	1	007300125



730/15 adaptor

1 1/2"



L mm	Ø mm	□	■	€	🔧	📄
105	84,0	1.1/2	1	161,50	1	007300810



Always apply torque loads evenly and progressively to avoid breakage and any possible injury.

733/15 adaptor

2 1/2"



L mm	Ø mm	□	■	€	🔧	📄
156	127	2.1/2	1.1/2	568,00	1	007330810

BITS

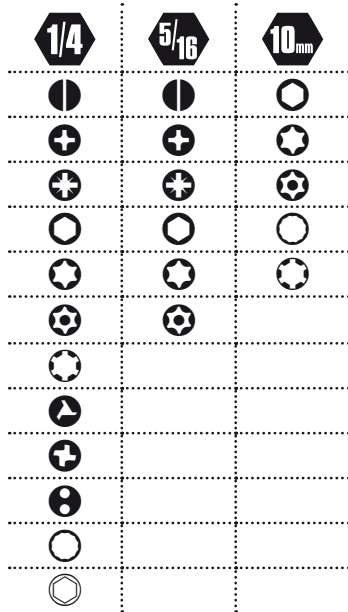

ISO 1173-C 6,3



retainer spring seat

ISO 1173-E 6,3



retainer ball slot

851

magnetic bit holder with handle

14



L1 mm	L mm	€	🔧	📄
45	165	15,00	2	008510165
125	245	17,40	2	008510245

851SR

quick release bit holder with handle

14



L mm	L1 mm	€	🔧	📄
230	110	20,80	2	008510001

852

bit holder with articulated T handle

14

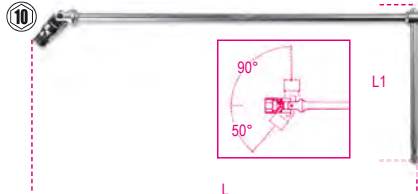

Ø	L mm	L1 mm	€	🔧	📄
1/4"	400	160	44,00	2	008520006
10 mm	400	160	44,00	2	008520010

855P

reversible ratchet bit holder with articulated handle, and 7 built-in bits

14



L mm	L1 mm	€	🔧	📄
240	100	68,50	1	008550010

- 860PH PH1 - PH2
- 860PZ PZ1 - PZ2
- 860LP LP 0,8x5,5 mm
- 860PE 4 - 5 mm

860LP

bits for slotted head screws, coloured

●

1/4



ISO 2351-1
ISO 1173 C 6,3

SxA mm	L mm	€	🔧	📄
0,5x3	25	1,79	5	008600005
0,6x4,5	25	1,79	5	008600010
0,8x5,5	25	1,79	5	008600015
1x5,5	25	1,79	5	008600020
1,2x6,5	25	1,79	5	008600025

860PH

bits for cross head Phillips® screws, coloured

+

1/4



ISO 2351-2
ISO 1173 C 6,3

PH	L mm	€	🔧	📄
0	25	1,79	5	008600220
1	25	1,79	5	008600225
2	25	1,79	5	008600230
3	25	1,79	5	008600245
4	25	2,59	5	008600250

860PZ

bits for cross head Pozidriv® - Supadriv® screws, coloured

+

1/4



ISO 2351-2
ISO 1173 C 6,3

PZ	L mm	€	🔧	📄
1	25	1,79	5	008600320
2	25	1,79	5	008600325
3	25	1,79	5	008600330
4	25	2,59	5	008600335

860PE

hexagon bits for power drivers, coloured

○

1/4



ISO 2351-3
ISO 1173 C 6,3

mm	L mm	€	🔧	📄
2	25	1,90	5	008600101
2,5	25	1,90	5	008600102
3	25	1,90	5	008600103
4	25	1,90	5	008600104
5	25	1,90	5	008600105
6	25	1,90	5	008600106
8	25	2,39	5	008600108
10	25	2,39	5	008600110

860TX

bits for Torx® head screws, coloured



ISO 1173 C 6,3

	L mm	€	1/4"	1/4"
T6	25	2,39	5	008600704
T7	25	2,39	5	008600705
T8	25	2,39	5	008600710
T9	25	2,39	5	008600715
T10	25	1,90	5	008600720
T15	25	1,90	5	008600725
T20	25	1,90	5	008600730
T25	25	1,90	5	008600735
T27	25	1,90	5	008600740
T30	25	1,90	5	008600745
T40	25	1,90	5	008600750

860RTX

bits for Tamper Resistant Torx® head screws, coloured



ISO 1173 C 6,3

	L mm	€	1/4"	1/4"
T9	25	2,59	5	008600550
T10	25	2,59	5	008600555
T15	25	2,59	5	008600560
T20	25	2,59	5	008600565
T25	25	2,59	5	008600570
T27	25	2,59	5	008600575
T30	25	2,59	5	008600580
T40	25	2,59	5	008600585

860/55

reversible bit ratchet



L mm	1/4"	€	1/4"	1/4"
100	1/4	30,50	3	008600870

860/58

bit ratchet with rotating handle

- Bit can be fitted onto both sides, for screwing or unscrewing
- Bi-material handle



L mm	1/4"	Ø mm	A mm	€	1/4"	1/4"	
860/58	126	1/4"	27	15	70,00	1	008600884

860/C27

25 bits, 1 connector and 1 reversible ratchet in plastic case



860/C27	€	1/4"	1/4"
	83,00	1	008600880

860/55	100 mm
860LP	0,5x3-1,0x5,5-1,2x6,5 mm
860PH	PH1-PH2(x2)-PH3
860PZ	PZ1-PZ2(x2)-PZ3
860PE	2-2,5-3-4-5-6 mm
860TX	T6-T8-T10-T15-T20-T25-T30-T40
892/0	● 1/4 ■ 1/4

860PHZ/A10

set of 10 bits with magnetic bit holder in plastic case



860PHZ/A10	€	1/4"	1/4"
	34,50	1	008600910

860PH	PH1	1	n.
	PH2	3	
	PH3	1	
860PZ	PZ1	1	
	PZ2	3	
	PZ3	1	
882M1	○ 1/4 ● 1/4		

860PE/A10

set of 10 bits with magnetic bit holder in plastic case



860PE/A10	€	1/4"	1/4"
	36,00	1	008600920

860PE	2-2,5 mm	1	n.
	3-4-5-6 mm	2	
882M1	○ 1/4 ● 1/4		

860TX/A10

set of 10 bits with magnetic bit holder in plastic case



860TX/A10	€	1/4"	1/4"
	37,00	1	008600970

860TX	T7 - T8 - T9 - T10 - T15 - T20	1	n.
	T25 - T27 - T30 - T40		
882M1	○ 1/4 ● 1/4		

860MIX/A10

set of 10 bits with magnetic bit holder in plastic case



860MIX/A10	€	1/4"	1/4"
	34,50	1	008600900

860LP	0,5x3 - 1x5,5 - 1,2x6,5 mm	1	n.
860PH	PH1	1	
	PH2	2	
	PH3	1	
860PZ	PZ1 - PZ2 - PZ3	1	
882M1	○ 1/4 ● 1/4		

860MIX/A31

set of 30 bits with magnetic quick release bit holder in plastic case



860MIX/A31	€	1/4"	1/4"
	81,50	1	008600902

860LP	0,5x3 - 0,6x4,5 - 0,8x5,5		
	1,0x5,5 - 1,2x6,5 mm		
860PE	2 - 2,5 - 3 - 4 - 5 - 6		
	8 - 10 mm		
860PH	PH0 - PH1 - PH2 - PH3 - PH4		
860PZ	PZ1 - PZ2 - PZ3 - PZ4		
860RTX	T9 - T10 - T15 - T20		
	T25 - T27 - T30 - T40		
882MSR 50	○ 1/4 ● 1/4		

860/C38P

1 reversible ratchet bit holder with articulated handle, 27 bits, 8 hexagon sockets and 2 accessories



860/C38P € 182,00 1 008600878

	860LP	0,6x4,5 - 0,8x5,5 - 1,0x5,5 - 1,2x6,5 mm
	860PE	2-2,5-3-4(x2)-5(x2)
	860PH	PH1(x2)-PH2(x2)-PH3
	860PZ	PZ1(x2)-PZ2(x2)-PZ3
	860TX	T10-T15-T20-T25-T30-T40
	900	5-5,5-6-7-8-9-10-13 mm
	892/0	● 1/4 ■ 1/4
	892/3	● 1/4 ■ 1/4
	855P	240 mm

270x120x45 mm

861LP

bits for slotted head screws



ISO 2351-1
ISO 1173 C 6,3

SxA mm	L mm	€	🔧	📦
0,5x3	25	1,16	10	008610005
0,6x4	25	1,16	10	008610007
0,6x4,5	25	1,16	10	008610010
0,8x5,5	25	1,16	10	008610015
1x5,5	25	1,16	10	008610020
1,2x6,5	25	1,16	10	008610025
1,2x8	25	2,21	10	008610028
1,6x8	25	2,21	10	008610030

861PH

bits for cross head Phillips® screws



ISO 2351-2
ISO 1173 C 6,3

PH	L mm	€	🔧	📦
0	25	1,14	10	008610200
1	25	1,14	10	008610205
2	25	1,14	10	008610210
2L	50	2,21	10	008610213
3	25	1,14	10	008610215
4	25	3,05	10	008610220

861PH/C

bits for cross head Phillips® screws



ISO 2351-2
ISO 1173 C 6,3

PH	L mm	€	🔧	📦
0	25	0,88	200	008610250
1	25	0,88	200	008610255
2	25	0,88	200	008610260
2L	50	1,68	100	008610263
3	25	0,88	200	008610265
4	25	2,25	100	008610270

861PZ

bits for cross head Pozidriv®-Supadriv® screws



ISO 2351-2
ISO 1173 C 6,3

PZ	L mm	€	🔧	📦
1	25	1,14	10	008610300
2	25	1,14	10	008610305
2L	50	2,19	10	008610308
3	25	1,14	10	008610310
4	25	3,05	10	008610315

861PZ/C

bits for cross head Pozidriv®-Supadriv® screws



ISO 2351-2
ISO 1173 C 6,3

PZ	L mm	€	🔧	📦
1	25	0,88	200	008610350
2	25	0,88	200	008610355
2L	50	1,68	100	008610358
3	25	0,88	200	008610360
4	25	2,21	100	008610365

861PE

hexagon bits for power drivers



ISO 2351-3
ISO 1173 C 6,3

mm	L mm	€	🔧	📦
2	25	1,22	10	008610100
2,5	25	1,22	10	008610105
3	25	1,22	10	008610110
4	25	1,22	10	008610115
5	25	1,22	10	008610120
6	25	1,22	10	008610125
8	25	1,85	10	008610130
10	25	2,44	10	008610135

861TX

bits for Torx® head screws



ISO 1173 C 6,3

T	L mm	€	🔧	📦
T5	25	1,62	10	008610399
T6	25	1,62	10	008610400
T7	25	1,62	10	008610405
T8	25	1,62	10	008610410
T9	25	1,62	10	008610415
T10	25	1,28	10	008610420
T15	25	1,28	10	008610425
T20	25	1,28	10	008610430
T25	25	1,28	10	008610435
T27	25	1,28	10	008610440
T30	25	1,28	10	008610445
T40	25	1,28	10	008610450

861TX/C

bits for Torx® head screws



ISO 1173 C 6,3

T	L mm	€	🔧	📦
T10	25	0,98	200	008610470
T15	25	0,98	200	008610475
T20	25	0,98	200	008610480
T25	25	0,98	200	008610485
T27	25	0,98	200	008610490
T30	25	0,98	200	008610495
T40	25	0,98	200	008610499

861RTX

bits for Tamper Resistant Torx® head screws

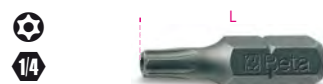

ISO 1173 C 6,3

T	L mm	€	🔧	📦
T6	25	2,39	10	008610537
T7	25	2,39	10	008610538
T8	25	2,39	10	008610540
T9	25	2,39	10	008610500
T10	25	2,39	10	008610505
T15	25	2,39	10	008610510
T20	25	2,39	10	008610515
T25	25	2,39	10	008610520
T27	25	2,39	10	008610525
T30	25	2,39	10	008610530
T40	25	2,39	10	008610535
T45	25	4,60	10	008610539



861RIBE

bits for RIBE® screws



ISO 1173 C 6,3

Ø	L mm	€	🔧	📦
M5	25	1,05	10	008610705
M6	25	1,05	10	008610706
M7	25	1,28	10	008610707
M8	25	1,28	10	008610708
M9	25	1,85	10	008610709

861TRW

bits for Tri-Wing® head screws



ISO 1173 C 6,3

GR	L mm	€	🔧	📦
1	25	2,03	10	008610601
2	25	2,03	10	008610602
3	25	2,03	10	008610603
4	25	2,03	10	008610604
5	25	2,03	10	008610605
6	25	2,96	10	008610606

861TQS

bits for Torq-Set® head screws



ISO 1173 C 6,3

GR	L mm	€	🔧	📦
0	25	2,03	10	008610620
1	25	2,03	10	008610621
2	25	2,03	10	008610622
3	25	2,03	10	008610623
4	25	2,03	10	008610624
5	25	2,03	10	008610625
6	25	2,03	10	008610626
8	25	2,03	10	008610628
10	25	2,03	10	008610630

861SP

bits for Spanner screws



ISO 1173 C 6,3

SP	D mm	L mm	€	🔧	📦
4	1,5	25	1,68	10	008610650
6	2,4	25	1,68	10	008610653
8	2,8	25	1,68	10	008610656
10	3,3	25	1,68	10	008610658
12	3,9	25	1,68	10	008610660

1483KV-PT/S7



1483KV PT/S7

184

861XZN

bits for XZN® screws



ISO 1173 C 6,3

Ø	L mm	€	🔧	📦
M5	25	1,05	10	008610725
M6	25	1,05	10	008610726
M8	25	1,34	10	008610728

861/C61P

61 bits and 1 magnetic quick release bit holder



861/C61P

€ 156,00 1 008610978

	861LP	0,5x3 - 0,6x4,5 - 0,8x5,5 - 1,0x5,5 1,2x6,5 - 1,2x8 - 1,6x8 mm
	861PE	2 - 2,5 - 3 - 4 - 5 - 6 - 8 - 10 mm
	861PH	PH0 - PH1 - PH2 - PH3
	861PZ	PZ1 - PZ2 - PZ3
	861TX	T6 - T7 - T8 - T9 - T10 - T15 T20 - T25 - T27 - T30 - T40
	861RTX	T9 - T10 - T15 - T20 - T25 T27 - T30 - T40
	861TRW	1 - 2 - 3 - 4 - 5 - 6
	861TQS	0 - 1 - 2 - 3 - 4 - 5 - 6 - 8 - 10
	861SP	4 - 6 - 8 - 10 - 12
	851SR	Ø 1/4"

270x120x45 mm - 975 g

862LP

bits for slotted head screws



ISO 2351-1

ISO 1173 E 6,3

SxA mm	L mm	€	🔧	📦
0,5x3	50	3,35	5	008620005
0,6x4,5	50	3,35	5	008620010
0,8x5,5	50	3,35	5	008620015
1x5,5	50	3,35	5	008620020
1,2x6,5	50	3,35	5	008620025
1,2x8	50	4,15	5	008620030
1,6x8	50	4,15	5	008620035

862PH

bits for cross head Phillips® screws



ISO 2351-2

ISO 1173 E 6,3

PH	L mm	€	🔧	📦
1	50	3,35	5	008620200
2	50	3,35	5	008620205
3	50	3,35	5	008620210

862PH/L

bits for cross head Phillips® screws



ISO 2351-2

ISO 1173 E 6,3

PH	L mm	€	🔧	📦
1	70	6,10	5	008620230
2	70	6,10	5	008620232
3	70	6,10	5	008620234

862PH-XL

bits for cross head Phillips® screws



ISO 2351-2 ISO 1173 E 6,3

PH	L mm	€	🔧	📦
1	100	6,30	5	008620250
2	100	6,30	5	008620252
3	100	6,30	5	008620254

862PZ

bits for cross head Pozidriv®-Supadriv® screws



ISO 2351-2

ISO 1173 E 6,3

PZ	L mm	€	🔧	📦
1	50	3,45	5	008620300
2	50	3,45	5	008620305
3	50	3,45	5	008620310

862PE

hexagon bits for power drivers



ISO 2351-3

ISO 1173 E 6,3

mm	L mm	€	🔧	📦
3	50	3,45	5	008620103
4	50	3,45	5	008620104
5	50	3,45	5	008620105
6	50	3,45	5	008620106
8	50	4,60	5	008620108

862TX

bits for Torx® head screws



ISO 1173 E 6,3

mm	L mm	€	🔧	📦
T6	50	4,55	5	008620506
T7	50	4,55	5	008620507
T8	50	4,55	5	008620508
T9	50	4,55	5	008620509
T10	50	4,55	5	008620510
T15	50	4,55	5	008620515
T20	50	4,55	5	008620520
T25	50	4,55	5	008620525
T27	50	4,55	5	008620527
T30	50	4,55	5	008620530
T40	50	4,55	5	008620540

862TX/L

bits for Torx® head screws



ISO 1173 E 6,3

mm	L mm	€	🔧	📦
T6	70	4,95	5	008620556
T7	70	4,95	5	008620557
T8	70	4,95	5	008620558
T9	70	4,95	5	008620559
T10	70	4,95	5	008620560
T15	70	4,95	5	008620565
T20	70	4,95	5	008620570
T25	70	4,95	5	008620575
T27	70	4,95	5	008620577
T30	70	4,95	5	008620580
T40	70	4,95	5	008620590

862TX-XL

bits for Torx® head screws



ISO 1173 E 6,3

mm	L mm	€	🔧	📦
T9	100	5,45	5	008620659
T10	100	5,45	5	008620660
T15	100	5,45	5	008620665
T20	100	5,45	5	008620670
T25	100	5,45	5	008620675
T27	100	5,45	5	008620677
T30	100	5,45	5	008620680
T40	100	5,45	5	008620690

862F

magnetic bits, hexagon sockets



ISO 1173 E 6,3

mm	L mm	Ø mm	€	🔧	📦
5,5	65	11	6,25	5	008620405
6	65	11	6,25	5	008620406
7	65	11	6,25	5	008620407
8	65	13	6,25	5	008620408
10	65	15	6,80	5	008620410
12	65	18	7,50	5	008620412
13	65	18	7,90	5	008620413

862F/A7

7 magnetic bits, hexagon sockets, in plastic case



862F/A7 € 47,00 1 008620950

862F 5,5-6-7-8-10-12-13 mm

866LP

bits for slotted head screws



ISO 2351-1
ISO 1173 C 8

SxA mm	L mm	€	🔧	📦
1x5,5	41	3,45	10	008660005
1,2x6,5	41	3,45	10	008660010
1,6x8	41	3,45	10	008660015
1,6x10	41	4,60	10	008660020
2x12	41	5,80	10	008660025

866PH

bits for cross head Phillips® screws



ISO 2351-2

ISO 1173 C 8

PH	L mm	€	🔧	📦
1	32	2,78	10	008660200
2	32	2,78	10	008660205
3	32	2,78	10	008660210
4	38	4,20	10	008660215

866PZ

bits for cross head Pozidriv®-Supadriv® screws



ISO 2351-2

ISO 1173 C 8

PZ	L mm	€	🔧	📦
1	32	2,89	10	008660300
2	32	2,89	10	008660305
3	32	2,89	10	008660310
4	38	4,40	10	008660315

866PE

hexagon bits for power drivers



ISO 2351-3

ISO 1173 C 8

mm	L mm	€	🔧	📦
3	30	2,39	10	008660100
4	30	2,39	10	008660105
5	30	2,39	10	008660110
6	30	2,39	10	008660115
7	30	2,39	10	008660117
8	30	2,39	10	008660120
10	30	3,35	10	008660125
12	30	4,60	10	008660132
14	30	6,00	10	008660134

866TX

bits for Torx® head screws



ISO 1173 C 8

mm	L mm	€	🔧	📦
T20	30	3,00	10	008660400
T25	30	3,00	10	008660405
T27	30	3,00	10	008660410
T30	30	3,00	10	008660415
T40	30	3,00	10	008660420
T45	30	3,00	10	008660425
T50	30	3,00	10	008660430
T55	30	4,35	10	008660435
T60	30	5,80	10	008660440
T70	30	6,45	10	008660445

866RTX

bits for Tamper Resistant Torx® head screws



ISO 1173 C 8

mm	L mm	€	🔧	📦
T40	30	3,45	10	008660520
T45	30	3,45	10	008660525
T50	30	3,45	10	008660530
T55	30	4,80	10	008660535
T60	30	6,25	10	008660540
T70	30	7,70	10	008660545

867PE

hexagon bits



mm	L mm	€	5	10
4	30	1,56	5	008670104
5	30	1,56	5	008670105
6	30	1,56	5	008670106
7	30	1,56	5	008670107
8	30	1,56	5	008670108
10	30	1,56	5	008670110
12	30	2,33	5	008670112

867PE/L

hexagon bits



mm	L mm	€	5	10
4	75	2,89	5	008670154
5	75	2,89	5	008670155
6	75	2,89	5	008670156
7	75	2,89	5	008670157
8	75	2,89	5	008670158
10	75	2,89	5	008670160
12	75	4,10	5	008670162

867XZN

bits with XZN® profile



mm	L mm	€	5	10
M4	30	1,96	5	008670204
M5	30	1,96	5	008670205
M6	30	1,96	5	008670206
M8	30	1,96	5	008670208
M10	30	1,96	5	008670210
M12	30	2,89	5	008670212

867XZN/L

bits with XZN® profile



mm	L mm	€	5	10
M5	75	3,20	5	008670255
M6	75	3,20	5	008670256
M8	75	3,20	5	008670258
M10	75	3,20	5	008670260
M12	75	4,40	5	008670262

867TX

bits for Torx® head screws



mm	L mm	€	5	10
T20	30	1,56	5	008670400
T25	30	1,56	5	008670405
T30	30	1,56	5	008670410
T40	30	1,56	5	008670415
T45	30	1,56	5	008670420
T50	30	1,56	5	008670425
T55	30	1,56	5	008670430

867TX/L

bits for Torx® head screws



mm	L mm	€	5	10
T20	75	2,56	5	008670450
T25	75	2,56	5	008670455
T30	75	2,56	5	008670460
T40	75	2,56	5	008670465
T45	75	2,56	5	008670470
T50	75	2,56	5	008670475
T55	75	2,56	5	008670480

867RTX

bits for Tamper Resistant Torx® head screws



mm	L mm	€	5	10
T20	30	1,74	5	008670500
T25	30	1,74	5	008670505
T30	30	1,74	5	008670510
T40	30	1,74	5	008670515
T45	30	1,74	5	008670520
T50	30	1,74	5	008670525
T55	30	1,74	5	008670530

867RTX/L

bits for Tamper Resistant Torx® head screws



mm	L mm	€	5	10
T20	75	2,89	5	008670550
T25	75	2,89	5	008670555
T30	75	2,89	5	008670560
T40	75	2,89	5	008670565
T45	75	2,89	5	008670570
T50	75	2,89	5	008670575
T55	75	2,89	5	008670580

867RIBE

bits for RIBE® screws



mm	L mm	€	5	10
M5	30	1,79	5	008670705
M6	30	1,79	5	008670706
M7	30	1,79	5	008670707
M8	30	1,79	5	008670708
M9	30	1,79	5	008670709
M10	30	1,79	5	008670710
M11	30	2,62	5	008670711
M12	30	2,62	5	008670712
M13	30	2,62	5	008670713

867RIBE/L

bits for RIBE® screws



mm	L mm	€	5	10
M5	75	2,89	5	008670755
M6	75	2,89	5	008670756
M7	75	2,89	5	008670757
M8	75	2,89	5	008670758
M9	75	2,89	5	008670759
M10	75	2,89	5	008670760
M11	75	3,95	5	008670761
M12	75	3,95	5	008670762
M13	75	3,95	5	008670763

867/...

bit holder sockets for item 867



mm	mm	L mm	mm	€	5	10	
867/1	10	3/8"	38	17	5,60	5	008670600
867/2	10	1/2"	38	22	6,35	5	008670601

867/C20

18 bits for RIBE® screws, with 10 mm hexagon drive and 2 accessories



mm	€	5	10
867/C20	111,50	1	008670920

- 867RIBE 5-6-7-8-9-10-11-12-13 mm
- 867RIBE/L 5-6-7-8-9-10-11-12-13 mm
- 867/1
- 867/2

335x145x60 mm - 1,7 kg

867/C38

38 hexagon bits, 10 mm, 1 bit holder with articulated T handle



867/C38 € 207,00 1 008670938

	852	10 mm
	867PE	4-5-6-7-8-10-12mm
	867PE/L	4-5-6-7-8-10-12mm
	867XZN	M5-M6-M8-M10-M12
	867XZN/L	M5-M6-M8-M10-M12
	867TX	T20-T25-T30-T40-T45-T50-T55
	867TX/L	T20-T25-T30-T40-T45-T50-T55
	882	

420x185x60 mm - 3 kg

867/C52

52 hexagon bits, 10 mm and 2 accessories

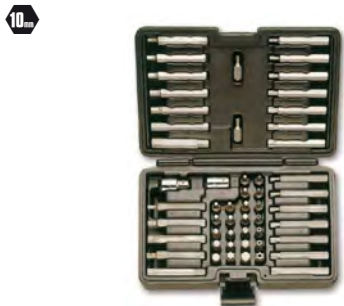

867/C52 € 126,50 1 008670901

	867PE	4-5-6-7-8-10-12 mm
	867PE/L	4-5-6-7-8-10-12 mm
	867XZN	M5-M6-M8-M10-M12
	867XZN/L	M5-M6-M8-M10-M12
	867TX	T20-T25-T30-T40-T45-T50-T55
	867TX/L	T20-T25-T30-T40-T45-T50-T55
	867RTX	T20-T25-T30-T40-T45-T50-T55
	867RTX/L	T20-T25-T30-T40-T45-T50-T55
	867/1	10 mm - □ 3/8"
	867/2	10 mm - □ 1/2"

250x170x70 mm - 2,1 kg

852



852 76,113

882

bit holder with retaining ring for drivers

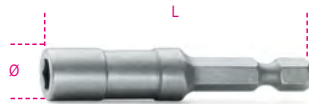

ISO 1173 E 6,3

L	∅	∅	€	5	008820001
mm	1/4	1/4	11	15,50	
57					

882AN

bevel gearbox, 1/4" hexagon drive

- For electric drills with 10 mm and 13 mm spindles and 1/4" impact wrenches
- Max. speed: 3600 rpm
- Max. torque: 30 Nm
- With quick change bit holder
- Gear ratio: 1:1
- Connection to tool through 1/4" hexagon D6.3



ISO 1173 E 6,3
ISO 1173 C 6,3

L	∅	∅	€	1	008820090
mm	1/4	1/4	137	67,50	

882M1

magnetic bit holder



ISO 1173 E 6,3

L	∅	∅	€	5	008820006
mm	1/4	1/4	11	16,50	
50					

882M

magnetic bit holder



ISO 1173 E 6,3

L	∅	∅	€	5	008820005
mm	1/4	1/4	11	20,00	
75					

882MSR

magnetic quick release bit holder for drivers



ISO 1173 E 6,3

L	∅	∅	€	5	008820205
mm	1/4	1/4	11	17,80	
75				20,80	5 008820207

882P

magnetic bit holder extension bar



L	∅	∅	€	5	008820080
mm	1/4	1/4	10	14,60	
80					

892

adaptors for drivers



	L	€	5	008920000
892/0	1/4	1/4	25	5,10
* 892/1	1/4	5,5	50	9,75
* 892/2	3/8	5,5	50	14,50
° 892/3	1/4	1/4	50	9,75
° 892/4	3/8	1/4	50	14,50
892/5	1/4	5/16	75	13,40
892/6	3/8	5/16	75	19,70
892/7	1/2	1/4	75	20,40

* ISO 1173 A 5,5
° ISO 1173 C 6,3



895

socket holder for bits
item 861 - 862 - 866



DIN 7427

	□	□	L mm	Ø mm	€	⚙️	📄
895/1	1/4	1/4	25,4	12	11,70	5	008950000
895/3	1/4	3/8	29	16,8	13,90	5	008950001
895/4	5/16	3/8	29	16,8	13,90	5	008950002
895/5	1/4	1/2	38	22	13,90	5	008950005
895/6	5/16	1/2	38	22	13,90	5	008950003

897

flexible bit holder with handle



L mm	L1 mm	€	⚙️	📄
280	154	26,50	2	008970010

897L

flexible bit holder with handle, long model

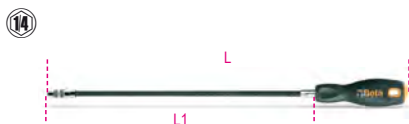

L mm	L1 mm	€	⚙️	📄
500	380	30,50	2	008970015

RATCHETS 9xx/55

Compact head



Operates in small spaces, at an angle of no more than 5°, thanks to the 72-tooth ring gear

Prevents slipping or releasing under tension

- Pressing of hand on ratchet head does not cause reversal and always allows free lever return
- One-handed reversal
- Outstanding mechanical characteristics



Reduced work load, 17 teeth in contact with gear at all times



900

hexagon hand sockets



UNI/ISO 2725 DIN 3124

mm	Ø mm	L mm	Ø1 mm	€	Hand	Code
3,2	6,6	25	11,8	3,80	10	009000032
4	6,8	25	11,8	3,80	10	009000040
4,5	7,4	25	11,8	3,80	10	009000045
5	8,0	25	11,8	3,80	10	009000050
5,5	8,7	25	11,8	3,80	10	009000055
6	9,3	25	11,8	3,80	10	009000060
7	10,4	25	11,8	3,80	10	009000070
8	11,8	25	12,7	3,80	10	009000080
9	12,7	25	11,8	3,80	10	009000090
10	14,2	25	12,0	3,80	10	009000100
11	15,8	25	12,5	3,80	10	009000110
12	17,2	25	13,5	3,80	10	009000120
13	18,0	25	13,5	3,85	10	009000130
14	20,0	25	15,0	3,90	10	009000140



900/SB13 € 64,50 1 009000150
4-4,5-5-5,5-6-7-8-9
10-11-12-13-14 mm

900MC

hexagon hand sockets, coloured

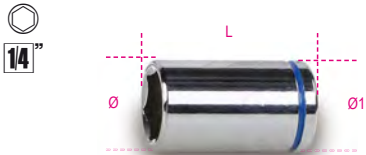

mm	L mm	Ø mm	Ø1 mm	€	Hand	Code
4	24,8	6,7	11,8	4,10	5	009002040
5	24,8	8,0	11,8	4,10	5	009002050
6	24,8	9,2	11,8	4,10	5	009002060
7	24,8	10,7	11,8	4,10	5	009002070
8	24,8	11,8	11,8	4,10	5	009002080
9	24,8	12,8	12,8	4,10	5	009002090
10	24,8	14,8	14,8	4,10	5	009002100
11	24,8	15,8	15,8	4,10	5	009002110
12	24,8	16,8	16,8	4,10	5	009002120
13	24,8	17,8	17,8	4,20	5	009002130
14	24,8	19,5	19,5	4,25	5	009002140

900MB

bi-hex hand sockets



UNI/ISO 2725 DIN 3124

mm	Ø mm	L mm	Ø1 mm	€	Hand	Code
4	6,7	22	11,2	7,45	5	009000160
5	7,7	25	11,2	7,45	5	009000161
5,5	8,3	25	11,2	7,45	5	009000162
6	9,0	25	11,2	7,45	5	009000163
7	10,2	25	11,2	7,45	5	009000164
8	11,3	25	12,0	7,45	5	009000165
9	13,0	25	12,0	7,45	5	009000166
10	14,3	25	12,9	7,45	5	009000167
11	16,0	25	14,3	7,45	5	009000168
12	17,4	25	16,0	7,45	5	009000169
13	18,0	25	16,4	8,25	5	009000170
14	19,3	25	17,9	8,65	5	009000171



900MB/SB12 € 105,50 1 009000179
4-5-5,5-6-7-8-9-10
11-12-13-14 mm

900L

hexagon hand sockets, long series



UNI/ISO 2725 DIN 3124

mm	Ø mm	L mm	Ø1 mm	€	Hand	Code
4	6,5	50	12,0	8,90	5	009000181
4,5	7,0	50	12,0	8,90	5	009000182
5	7,5	50	12,0	8,90	5	009000183
5,5	8,5	50	12,0	8,90	5	009000184
6	9,5	50	12,0	8,90	5	009000185
7	10,5	50	12,0	8,90	5	009000186
8	12,0	50	12,0	8,90	5	009000187
9	13,0	50	13,0	8,90	5	009000188
10	14,0	50	14,0	9,30	5	009000189
11	16,0	50	16,0	9,30	5	009000190
12	17,5	50	17,5	9,30	5	009000191
13	17,5	50	17,5	9,30	5	009000192
14	20,0	50	20,0	9,30	5	009000193



900L/SB13 € 132,50 1 009000203
4-4,5-5-5,5-6-7-8-9-10-11-12-13-14 mm

900MB/L

bi-hex hand sockets, long series



UNI/ISO 2725 DIN 3124

mm	Ø mm	L mm	Ø1 mm	€	Hand	Code
5	8,0	50	12,0	13,70	3	009000211
6	9,3	50	12,0	13,70	3	009000212
7	10,9	50	12,0	13,70	3	009000213
8	11,6	50	12,0	13,70	3	009000214
9	13,0	50	12,0	13,70	3	009000215
10	14,3	50	12,8	14,60	3	009000216
11	16,0	50	14,2	14,60	3	009000217
12	17,4	50	15,5	14,60	3	009000218
13	18,0	50	16,2	14,80	3	009000219
14	19,0	50	17,1	15,00	3	009000220

900AS

hexagon hand sockets



mm	Ø mm	L mm	Ø1 mm	€	Hand	Code
5/32	8,8	25	11,9	4,20	5	009000349
3/16	7,7	25	11,9	4,20	5	009000340
7/32	8,8	25	11,9	4,20	5	009000345
1/4	9,6	25	11,9	4,20	5	009000350
9/32	10,2	25	11,9	4,20	5	009000355
5/16	11,3	25	11,9	4,20	5	009000360
11/32	12,7	25	11,6	4,20	5	009000365
3/8	14,0	25	12,9	4,20	5	009000370
7/16	15,3	25	14,5	4,20	5	009000375
1/2	17,5	25	16,4	4,25	5	009000380
9/16	19,0	25	17,9	4,30	5	009000385



900AS/SB11 € 59,50 1 009000389
3/16-7/32-5/32-1/4-9/32-5/16-11/32-3/8-
7/16-1/2-9/16

900AS/MB

bi-hex hand sockets



SAE AS 954E

"	Ø mm	L mm	Ø1 mm	€	Hand	Code
3/16	7,7	22	10,9	7,55	2	009000390
7/32	8,5	22	10,9	7,55	2	009000391
1/4	9,4	22	10,9	7,55	2	009000392
9/32	10,2	22	10,9	7,55	2	009000393
5/16	11,3	22	11,7	7,55	2	009000394
11/32	12,5	22	12,0	7,55	2	009000395
3/8	13,7	22	12,9	8,10	2	009000396
7/16	15,6	22	14,3	8,10	2	009000397
1/2	17,2	22	16,4	8,95	2	009000398
9/16	18,8	24	17,9	9,05	2	009000399



900AS/L

hexagon hand sockets, long series



SAE AS 954E

"	Ø mm	L mm	Ø1 mm	€		
3/16	7,0	50	12,0	9,35	2	009000301
7/32	8,5	50	12,0	9,35	2	009000303
1/4	9,8	50	12,0	9,35	2	009000305
9/32	10,5	50	12,0	9,35	2	009000307
5/16	12,0	50	12,0	9,35	2	009000309
11/32	13,0	50	13,0	9,35	2	009000311
3/8	14,0	50	14,0	9,35	2	009000313
7/16	16,0	50	16,0	9,35	2	009000315
1/2	17,5	50	17,5	9,35	2	009000317
9/16	20,0	50	20,0	9,95	2	009000319

900AS/MBL

bi-hex hand sockets, long series



"	Ø mm	L mm	Ø1 mm	€		
5/32	6,8	50	12,0	14,50	2	009000325
3/16	8,0	50	12,0	14,50	2	009000326
7/32	8,5	50	12,0	14,50	2	009000327
1/4	9,8	50	12,0	14,50	2	009000328
9/32	10,9	50	12,0	14,50	2	009000329
5/16	11,6	50	12,0	14,50	2	009000330
11/32	13,0	50	12,0	14,50	2	009000331
3/8	14,3	50	12,8	15,50	2	009000332
7/16	16,0	50	14,2	15,50	2	009000333
1/2	18,0	50	16,2	15,50	2	009000334
9/16	19,0	50	17,1	15,50	2	009000335

900U

gear lock hand sockets

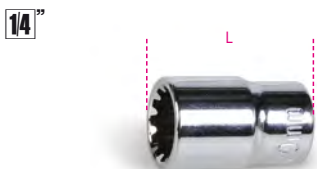

mm	"	Ø	Ø1	€		
4	5/32	E5	M5	4,00	5	009001702
4,5	3/16	E6		4,00	5	009001703
5	13/64		M6	4,00	5	009001704
5,5	7/32	E7		4,00	5	009001705
6	1/4	E8	M8	4,00	5	009001706
7	9/32			4,00	5	009001707
8	5/16	E10	M10	4,00	5	009001708
9	11/32			4,00	5	009001709
10	3/8	E12	M12	4,00	5	009001710
11	7/16	E14	M14	4,00	5	009001711
12	15/32	E16		4,00	5	009001712
13	1/2		M16	4,05	5	009001713
14	9/16	E18	M18	4,10	5	009001714

14"



900U/SB13	€		
4-4,5-5-5,5-6-7-8-9	67,00	1	009001750
10-11-12-13-14 mm			

900FTX

hand sockets for Torx® head screws



Ø mm	L mm	Ø1 mm	€			
E4	5,4	22	11,2	7,10	5	009000404
E5	6,7	22	11,2	7,10	5	009000405
E6	7,7	22	11,2	7,10	5	009000406
E7	8,3	22	11,2	7,10	5	009000407
E8	9,6	22	11,2	7,10	5	009000408
E10	11,3	22	12,0	7,10	5	009000410
E11	12,1	22	12,5	9,70	5	009000411
E12	12,9	23	12,9	9,70	5	009000412
E14	14,0	25	14,0	9,70	5	009000414

14"



900FTX/SB9	€		
E4-E5-E6-E7-E8	83,00	1	009000419
E10-E11-E12-E14			

900LP

socket drivers for slotted head screws

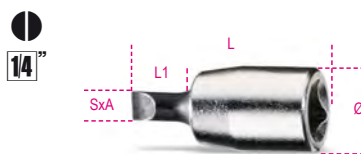

SxA mm	Ø mm	L mm	L1 mm	€		
0,8x4	12	28	9	8,55	5	009000605
1x5,5	12	28	9	8,55	5	009000610
1,2x6,5	12	28	9	8,55	5	009000615
1,2x8	13	28	8	8,55	5	009000620
1,6x10	14	28	8	8,55	5	009000625

900MC/LP

socket drivers for slotted head screws, coloured

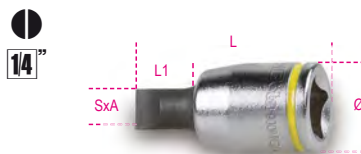

SxA mm	Ø mm	L mm	L1 mm	€		
0,8x4	12	28	9	13,40	3	009002605
1,2x6,5	12	28	9	13,40	3	009002615
1,2x8	13	28	8	13,40	3	009002620

900PH

socket drivers for cross head Phillips® screws



PH	Ø mm	L mm	L1 mm	€		
1	12	28	12	9,35	5	009000701
2	12	28	12	9,35	5	009000702
3	12	28	12	9,35	5	009000703
4	13	28	11	9,35	5	009000704



900PH/SB4	€		
PH1-PH2-PH3-PH4	44,00	1	009000708

900MC/PH

socket drivers for cross head Phillips® screws, coloured

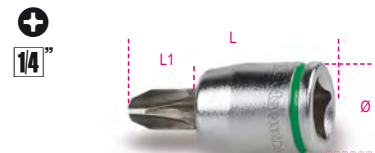

PH	Ø mm	L mm	L1 mm	€		
1	12	28	12	14,00	3	009002701
2	12	28	12	14,00	3	009002702
3	12	28	12	14,00	3	009002703

900PZ

socket drivers for cross head Pozidriv®-Supadriv® screws



PZ	Ø mm	L mm	€		
1	12	28	9,85	3	009000711
2	12	28	9,85	3	009000712
3	12	28	9,85	3	009000713

900ME

socket drivers for hexagon screws



mm	Ø mm	L mm	L1 mm	€	5	10
2,5	12	25	4,5	8,10	5	009000502
3	12	25	5,0	8,10	5	009000503
4	12	25	5,6	8,10	5	009000504
5	12	25	6,3	8,10	5	009000505
6	12	25	7,6	8,10	5	009000506
7	13	25	7,2	8,10	5	009000507
8	13	25	8,0	8,10	5	009000508
10	13	25	8,7	10,00	5	009000510



900ME/SB8	77,00	1	009000518
2,5-3-4-5-6-7-8-10 mm			

900PE/AS

socket drivers for hexagon screws



"	Ø mm	L mm	€	5	10
1/8	11,9	25	18,40	5	009000521
5/32	11,9	25	18,40	5	009000522
3/16	11,9	25	18,40	5	009000523
7/32	11,9	25	18,40	5	009000524
1/4	11,9	25	18,40	5	009000525
9/32	13,1	25	18,40	5	009000526
5/16	13,1	25	18,40	5	009000527

900PT

socket drivers for 5-star head screws



PT	Ø mm	L mm	L1 mm	€	5	10
PT10	12	28	12	17,10	5	009000750
PT15	12	28	12	17,10	5	009000755
PT20	12	28	12	17,10	5	009000760
PT25	12	28	12	17,10	5	009000765
PT27	12	28	12	17,10	5	009000767
PT30	12	28	12	17,10	5	009000770

900TX

socket drivers for Torx® head screws



T	Ø mm	L mm	L1 mm	€	5	10
T6	12	28	12	12,50	5	009000717
T7	12	28	12	12,50	5	009000718
T8	12	28	12	12,60	5	009000719
T9	12	28	12	12,60	5	009000720
T10	12	28	12	12,60	5	009000721
T15	12	28	12	12,60	5	009000722
T20	12	28	12	12,60	5	009000723
T25	12	28	12	12,60	5	009000724
T27	12	28	12	12,60	5	009000725
T30	12	28	12	12,60	5	009000726
T40	12	28	12	12,60	5	009000727



900TX/SB8	111,00	1	009000730
T9-T10-T15-T20 T25-T27-T30-T40			

900MC/TX

socket drivers for Torx® head screws, coloured



T	Ø mm	L mm	L1 mm	€	5	10
T10	12	28	12	14,50	3	009002721
T15	12	28	12	14,50	3	009002722
T20	12	28	12	14,50	3	009002723
T25	12	28	12	14,50	3	009002724
T27	12	28	12	14,50	3	009002725
T30	12	28	12	14,50	3	009002726
T40	12	28	12	14,50	3	009002727

900/16

adaptor, 1/4" female and 3/8" male drives



UNI/ISO 3316 DIN 3123

L mm	Ø mm	□	■	€	5	10
28	13,0	1/4	3/8	6,55	5	009000814

900/...

1/4" female and male drive extension bars

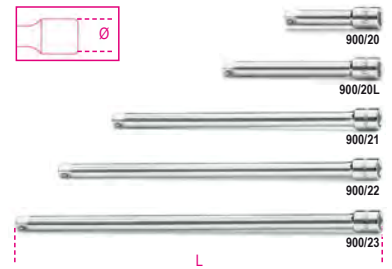

UNI/ISO 3316 DIN 3123

	L mm	Ø mm	€	5	10
900/20	50	11,5	8,35	5	009000818
900/20L	100	11,5	8,55	5	009000819
900/21	150	11,5	8,95	5	009000822
900/22	250	11,5	13,10	5	009000823
900/23	350	11,5	15,80	5	009000824

900AN

1/4" wobble extension bars

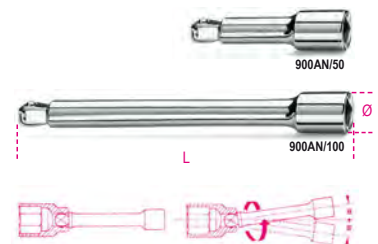

	L mm	Ø mm	€	5	10
900AN/50	50	11,5	9,05	3	009000825
900AN/100	100	11,5	9,95	3	009000826

900FL

1/4" flexible universal extension bar

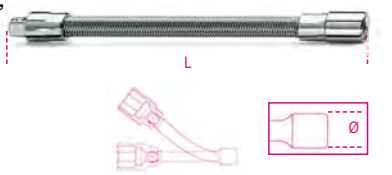

L mm	Ø mm	€	5	10
150	12	13,30	3	009000828

900/25

1/4" drive universal joint



UNI/ISO 3316 DIN 3123

L mm	Ø mm	€	5	10
41	12,5	16,30	5	009000830

900BG/30C

1/4" drive spinner handle



UNI/ISO 3315 DIN 3122

L	L1	€		
mm	mm			
128	20	8,00	5	009000833

900BG/30

1/4" drive spinner handle



UNI/ISO 3315 DIN 3122

L	L1	€		
mm	mm			
176	68	8,35	5	009000834

900/32

1/4" drive flexible handle



L	L1	€		
mm	mm			
280	154	19,20	2	009000839

900/35A

1/4" drive swivel handle



UNI/ISO 3315 DIN 3122

L	L1	€		
mm	mm			
148	84	27,50	5	009000840

900M/35

1/4" swivel drive with metal handle



UNI/ISO 3315
DIN 3122

L	€		
mm			
130	35,50	3	009000845



900/40

1/4" drive swivel T-handle



L	L1	€		
mm	mm			
390	145	36,50	3	009000843

900/42

1/4" drive sliding T-handle

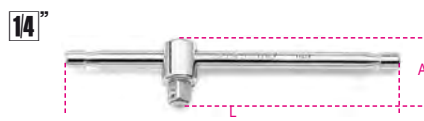

UNI/ISO 3315 DIN 3122

L	A	€		
mm	mm			
115	22	9,15	5	009000854

900T/44

1/4" male drive, bent,
with high torque handle



L	L1	€		
mm	mm			
238	105	13,80	2	009000860

900/55

1/4" drive reversible ratchet, 48 teeth



UNI/ISO 3315 DIN 3122

L	Ø	A	€	
mm	mm	mm		
125	25	29	44,00	5 009000870

900/55Z

72



Ratchet 900/55Z was developed by Beta's Technical Department with a new 72-tooth mechanism, 15 teeth being in contact with the gear at all times.

Therefore, the work load is distributed over a large number of teeth, thereby resulting in reduced wear of the individual parts and in an extremely long work life.



In addition, the 72 teeth ensure a take-up angle of no more than 5° and an extremely compact head, thereby providing quick access to smaller spaces as well.

Beta's ergonomic bi-material handle allows both quick use of the ratchet and the application of increased force.

900/55Z

1/4" drive reversible ratchet, 72 tooth mechanism



L	Ø	A	€	
mm	mm	mm		
126	25	23	44,00	3 009000882

900M/55

1/4" drive reversible ratchet with metal handle



UNI/ISO 3315 DIN 3122					
L	Ø	A	€		
mm	mm	mm	56,50	3	009000905
110	22	18			

Spare parts rotating mechanism of ratchets, see table after item 929/C8

900/58

1/4" drive reversible ratchet with rotating handle, 52 tooth mechanism

- Socket release button
- Ring nut reversal system on ratchet head
- Bi-material handle



L	Ø	A	€		
mm	mm	mm	66,50	2	009000884
126	28	28,5			

900/C39N

11 hexagon sockets, 21 bits and 7 accessories



900/C39N	€		
192,00	1	009000947	

861LP	0,6x4,5 - 1,2x6,5 - 1,2x8 mm
861PH	PH1-PH2-PH3
861PZ	PZ1-PZ2-PZ3
861PE	2,5-3-4-5-6 mm
861RTX	T10-T15-T20-T25-T27-T30-T40
900	5-5,5-6-7-8-9-10-11-12-13-14 mm
900/20	50 mm
900/20L	100 mm
900/25	
900BG/30C	128 mm
892/0	
895/1	
900/55Z	126 mm

900/C39U

11 gear lock sockets, 21 bits and 7 accessories



900/C39U	€		
194,50	1	009001947	

861LP	0,6x4,5 - 1,2x6,5 - 1,2x8 mm
861PH	PH1-PH2-PH3
861PZ	PZ1-PZ2-PZ3
861PE	2,5-3-4-5-6 mm
861RTX	T10-T15-T20-T25-T27-T30-T40
900U	○ 5-5,5-6-7-8-9-10-11-12-13-14 mm * 3/16-1/32-1/16-1/8-1/4-3/8-1/2-5/8-3/4-7/8-1-1 1/8-1 1/4-1 1/2-1 3/4-1 1/2-9/16-11/32-3/8-7/16-15/32-1/2-9/16 ⊙ E6-E7-E8-E10-E12-E14-E16-E18 ○ M6-M8-M10-M12-M14-M16-M18
900/20	50 mm
900/20L	100 mm
900/25	
900BG/30C	128 mm
892/0	
895/1	
900/55Z	126 mm

900/C11

11 hexagon sockets, 20 bits and 8 accessories



900/C11	€		
211,50	1	009000971	

861LP	0,5x3 - 0,8x5,5 1x5,5 - 1,2x6,5 mm
861PE	3 - 4 - 5 - 6 - 8 mm
861PH	0 - 1 - 2 - 3
861TX	T8 - T10 - T15 - T20 T25 - T30 - T40
895/1	
900	5 - 5,5 - 6 - 7 - 8 - 9 - 10 11 - 12 - 13 - 14 mm
900/16	□ 1/4 - ■ 3/8
900/20	50 mm
900/21	150 mm
900/25	
900BG/30	176 mm
900/42	
900/55	

270x120x45 mm - 1,2 kg

900/C11Z

11 hexagon sockets, 20 bits and 8 accessories



900/C11Z	€		
211,50	1	009000984	

861LP	0,5x3 - 0,8x5,5 - 1x5,5 - 1,2x6,5 mm
861PE	3 - 4 - 5 - 6 - 8 mm
861PH	0 - 1 - 2 - 3
861TX	T8 - T10 - T15 - T20 T25 - T30 - T40
895/1	
900	5 - 5,5 - 6 - 7 - 8 - 9 - 10 11 - 12 - 13 - 14 mm
900/16	□ 1/4 - ■ 3/8
900/20	50 mm
900/21	150 mm
900/25	
900BG/30	176 mm
900/42	
900/55Z	

350x150x50 mm - 1,2 kg

900/C12MR

12 hexagon sockets, 20 bits and 7 accessories in foam tray, in metal case



900/C12MR	€		
236,00	1	009000962	

900	4-5-5,5-6-7-8-9-10-11-12-13-14 mm
900/20	50 mm
900/21	150 mm
900/25	
900/42	115 mm
900BG/30	128 mm
900/58	
895/1	
861TX	T8-T10-T15-T20-T25-T30-T40
861PH	PH0-PH1-PH2-PH3
861LP	0,5-0,8-1-1,2 mm
861PE	3-4-5-6-8 mm

350x150x50 mm - 1,3 kg

900/C12MZ

12 hexagon sockets, 20 bits and 7 accessories in foam tray

1/4"

14"



900/C12MZ € 213,50 1 009000983

- 900 4-5-5,5-6-7-8-9-10-11-12-13-14 mm
- 900/20 50 mm
- 900/21 150 mm
- 900/25
- 900/42 115 mm
- 900BG/30 176 mm
- 900/55Z
- 895/1
- 861TX T8-T10-T15-T20-T25-T30-T40
- 861PH PH0-PH1-PH2-PH3
- 861LP 0,5x3 - 0,8x5,5 - 1x5,5 - 1,2x6,5 mm
- 861PE 3-4-5-6-8 mm

350x150x50 mm - 1,2 kg

900/C13-5

13 hexagon sockets and 5 accessories

1/4"



900/C13-5 € 172,50 1 009000953

- 900 4-4,5-5-5,5-6-7-8-9
- 10-11-12-13-14 mm
- 900/21 150 mm
- 900/25
- 900BG/30
- 900/42
- 900/55

270x120x45 mm - 1 kg

900/C13-8

13 hexagon sockets and 8 accessories

1/4"



900/C13-8 € 209,50 1 009000954

- 900 4-4,5-5-5,5-6-7-8-9
- 10-11-12-13-14 mm
- 900/16 □ 1/4 - ■ 3/8
- 900/20 50 mm
- 900/21 150 mm
- 900/25
- 900BG/30
- 900/35A
- 900/42
- 900/55

270x120x45 mm - 1,1 kg

900MB/C19

11 bi-hex sockets and 8 accessories

1/4"



900MB/C19 € 244,00 1 009000977

- 900MB 5-5,5-6-7-8-9-10-11
- 12-13-14 mm
- 900/16 □ 1/4 - ■ 3/8
- 900/20 50 mm
- 900/21 150 mm
- 900/25
- 900BG/30
- 900/35A
- 900/42
- 900/55

270x120x45 mm - 1,1 kg

900/C24

13 hexagon sockets, 11 socket drivers and 6 accessories

1/4"



900/C24 € 270,00 1 009000956

- 900 4-4,5-5-5,5-6-7-8-9
- 10-11-12-13-14 mm
- 900LP 0,8x4 - 1,2x6,5 - 1,2x8 mm
- 900PH PH1 - PH2 - PH3
- 900ME 3-4-5-6-8 mm
- 900/20 50 mm
- 900/21 150 mm
- 900/25
- 900BG/30
- 900/42
- 900/55

270x120x45 mm - 1,1 kg

900MB/C28

11 bi-hex sockets, 11 socket drivers and 6 accessories

1/4"



900MB/C28 € 304,00 1 009000979

- 900MB 5-5,5-6-7-8-9-10-11
- 12-13-14 mm
- 900LP 0,8x4 - 1,2x6,5 - 1,2x8 mm
- 900PH PH1 - PH2 - PH3
- 900ME 3-4-5-6-8 mm
- 900/20 50 mm
- 900/21 150 mm
- 900/25
- 900BG/30
- 900/42
- 900/55

270x120x45 mm - 1,1 kg



900MC/C24

11 hexagon sockets,
13 coloured socket drivers and 6 accessories

1/4"



900MC/C24 € 355,00 1 009002960

- 900MC 4 - 5 - 6 - 7 - 8 - 9
10 - 11 - 12 - 13 - 14 mm
 - 900MC/PH PH1 - PH2 - PH3
 - 900MC/TX T10 - T15 - T20 - T25 - T27 - T30 - T40
 - 900MC/LP 0,8x4 - 1,2x6,5 - 1,2x8 mm
 - 900/20 50 mm
 - 900/21 150 mm
 - 900/25
 - 900BG/30
 - 900/42
 - 900/55
- 270x120x45 mm - 1 kg

900MC/C32

11 coloured sockets, 20 coloured bits and 7 accessories

1/4"



900MC/C32 € 221,00 1 009002963

- 900MC 4 - 5 - 6 - 7 - 8 - 9 - 10 - 11 - 12 - 13 - 14 mm
 - 860LP 0,5x3 - 0,8x5,5 - 1,0x5,5 - 1,2x6,5 mm
 - 860PH 0 - 1 - 2 - 3
 - 860PE 3 - 4 - 5 - 6 - 8 mm
 - 860TX T8 - T10 - T15 - T20 - T25 - T30 - T40
 - 895/1
 - 900/20
 - 900/21
 - 900/25
 - 900BG/30
 - 900/42
 - 900/55
- 270x120x45 mm - 1,2 kg

900U/C12M

12 gear lock hand sockets,
20 bits and 7 accessories,
in soft foam tray

1/4"

1/4"



900U/C12M € 216,00 1 009001792

- 900U ○ 4-5-5,5-6-7-8-9-10-11-12-13-14 mm
* 5/32-3/16-13/64-7/32-1/4-9/32-5/16
11/32-3/8-7/16-15/32-1/2-9/16
 - 900/20 50 mm
 - 900/21 150 mm
 - 900/25
 - 900/42 115 mm
 - 900BG/30 176 mm
 - 900/55 125 mm
 - 895/1 ○ 1/4 - □ 1/4
 - 861LP 0,5x3 - 0,8x5,5 - 1,0x5,5 - 1,2x6,5 mm
 - 861PE 3-4-5-6-8 mm
 - 861PH PH0-PH1-PH2-PH3
 - 861TX T8-T10-T15-T20-T25-T30-T40
- 350x150x50 mm - 1,2 kg

900AS/C10 - /MB-C17

10 sockets and 7 accessories

1/4"



900AS/C10 € 195,50 1 009000961

- 900AS 3/16 - 7/32 - 1/4 - 9/32 - 5/16
11/32 - 3/8 - 7/16 - 1/2 - 9/16
 - 900/20 50 mm
 - 900/21 150 mm
 - 900/25
 - 900BG/30
 - 900/35A
 - 900/42
 - 900/55
- 270x120x45 mm - 1,1 kg

900AS/MB-C17 € 233,00 1 009000981

- 900AS/MB 3/16 - 7/32 - 1/4 - 9/32 - 5/16
11/32 - 3/8 - 7/16 - 1/2 - 9/16
 - 900/20 50 mm
 - 900/21 150 mm
 - 900/25
 - 900BG/30
 - 900/35A
 - 900/42
 - 900/55
- 270x120x45 mm - 1,1 kg

900AS/C17-MBM

10 bi-hex sockets
and 7 accessories
for aeronautical maintenance

1/4"



900AS/C17-MBM € 254,00 1 009000982

- 900AS/MB 3/16 - 7/32 - 1/4 - 9/32 - 5/16
11/32 - 3/8 - 7/16 - 1/2 - 9/16
 - 900/20 50 mm
 - 900/21 150 mm
 - 900/25
 - 900BG/30
 - 900M/35
 - 900/42
 - 900M/55
- 270x120x45 mm - 1,2 kg

 **Beta**

900/C11HR

11 hexagon sockets,
20 bits and 7 accessories
in hard foam tray,
in metal case

• ratchet with rotating handle

1/4"

14"



900/C11HR

€ 234,00 1 009000980

- 861LP 0,5x3-0,8x5,5-1x5,5-1,2x6,5 mm
- 861PH PH0-PH1-PH2-PH3
- 861PE 3-4-5-6-8 mm
- 861TX T8-T10-T15-T20-T25-T30-T40
- 895/1
- 900 5-5,5-6-7-8-9-10-11-12-13-14 mm
- 900/16 □ 1/4 - ■ 3/8
- 900/20 50 mm
- 900/21 150 mm
- 900/25
- 900/42
- 900BG/30
- 900/58

≡ 350x150x50 mm - 1,3 kg

902R/C6

6 adaptors for socket drivers



902R/C6

€ 89,00 1 009020814

- 900/16 □ 1/4 - ■ 3/8
- 910/15 □ 3/8 - ■ 1/4
- 910/16 □ 3/8 - ■ 1/2
- 920/15 □ 1/2 - ■ 3/8
- 920/16 □ 1/2 - ■ 3/4
- 928/15 □ 3/4 - ■ 1/2

≡ 170x100x35 mm - 600 g

902A/C22

22 hexagon sockets and 6 accessories
in metal case

14"

12"



902A/C22

€ 341,00 1 009020807

- 900 5-5,5-6-7-8-9-10-11-12-13 mm
- 900/20 50 mm
- 900/25
- 900/55
- 920A 10-13-14-15-17-18-19-22-24-27-30-32 mm
- 920/21 125 mm
- 920/25
- 920/55

≡ 420x185x60 mm - 3,5 kg

910A

hexagon hand sockets

3/8"

38"



UNI/ISO 2725 DIN 3124

mm	Ø mm	L mm	Ø1 mm	€	5	10
6	9,5	28	16,7	5,95	5	009100006
7	10,7	28	16,7	5,95	5	009100007
8	12,1	28	16,7	5,95	5	009100008
9	13,2	28	16,7	5,95	5	009100009
10	14,6	29	16,7	5,95	5	009100010
11	15,8	29	16,7	5,95	5	009100011
12	17,2	30	17,7	6,20	5	009100012
13	18,4	31	17,0	6,20	5	009100013
14	19,7	32	17,5	6,20	5	009100014
15	20,9	32	18,0	6,20	5	009100015
16	22,2	33	18,5	6,95	5	009100016
17	23,2	33	19,0	6,95	5	009100017
18	24,7	34	20,0	6,95	5	009100018
19	25,8	35	21,0	6,95	5	009100019
20	27,2	35	22,0	7,45	5	009100020
21	28,2	36	23,0	7,45	5	009100021
22	29,7	37	24,0	7,65	5	009100022

3/8"

38"



910A/SB17

6-7-8-9-10-11-12
13-14-15-16-17
18-19-20-21-22 mm

€ 130,00 1 009100030

910B

bi-hex hand sockets

3/8"

38"



UNI/ISO 2725 DIN 3124

mm	Ø mm	L mm	Ø1 mm	€	5	10
6	9,5	28	16,7	5,95	5	009100106
7	10,7	28	16,7	5,95	5	009100107
8	12,1	28	16,7	5,95	5	009100108
9	13,2	28	16,7	5,95	5	009100109
10	14,6	29	16,7	5,95	5	009100110
11	15,8	29	16,7	5,95	5	009100111
12	17,2	30	17,7	6,20	5	009100112
13	18,4	31	17,0	6,20	5	009100113
14	19,7	32	17,5	6,20	5	009100114
15	20,9	32	18,0	6,20	5	009100115
16	22,2	33	18,5	6,95	5	009100116
17	23,2	33	19,0	6,95	5	009100117
18	24,7	34	20,0	6,95	5	009100118
19	25,8	35	21,0	6,95	5	009100119
20	27,2	35	22,0	7,45	5	009100120
21	28,2	36	23,0	7,45	5	009100121
22	29,7	37	24,0	7,65	5	009100122

3/8"

38"



910B/SB17

6-7-8-9-10-11-12
13-14-15-16-17
18-19-20-21-22 mm

€ 130,00 1 009100130

910AL

hexagon hand sockets,
long series

3/8"

38"



UNI/ISO 2725 DIN 3124

mm	Ø mm	L mm	Ø1 mm	€	5	10
8	12,0	55	17	12,80	3	009100158
9	13,0	55	17	12,80	3	009100159
10	14,5	55	17	12,80	3	009100160
11	16,0	55	17	12,80	3	009100161
12	17,0	55	17	12,80	3	009100162
13	18,0	55	17	14,00	3	009100163
14	20,0	55	18	14,00	3	009100164
15	21,0	55	20	14,00	3	009100165
16	22,0	55	20	14,00	3	009100166
17	23,5	55	22	14,00	3	009100167
18	24,5	55	23	15,30	2	009100168
19	25,0	55	24	15,30	2	009100169
21	27,0	65	26	16,50	2	009100171
22	29,0	65	28	16,50	2	009100172

910AL/SB14

8-9-10-11-12-13-14
15-16-17-18-19-21-22 mm

€ 214,00 1 009100174

910BL

bi-hex hand sockets, long series



UNI/ISO 2725 DIN 3124

mm	Ø	L	Ø1	€	U	PC
8	12,0	55	17	12,80	3	009100308
9	13,0	55	17	12,80	3	009100309
10	14,5	55	17	12,80	3	009100310
11	16,0	55	17	12,80	3	009100311
12	17,0	55	17	12,80	3	009100312
13	18,0	55	17	14,00	3	009100313
14	20,0	55	18	14,00	3	009100314
15	21,0	55	20	14,00	3	009100315
16	22,0	55	20	14,00	3	009100316
17	23,5	55	22	14,00	3	009100317
18	24,5	55	23	15,30	2	009100318
19	25,0	55	24	15,30	2	009100319
21	27,0	65	26	16,50	2	009100321
22	29,0	65	28	16,50	2	009100322



910BL/SB14 € 214,00 U 1 009100340
8-9-10-11-12-13
14-15-16-17-18
19-21-22 mm

910B/SN

swivel end bi-hex hand sockets



mm	Ø	L	Ø1	€	U	PC
10	14,5	48,5	19	33,50	2	009100230
11	15,8	49,5	19	33,50	2	009100231
12	17,0	50,0	19	33,50	2	009100232
13	18,3	51,0	19	33,50	2	009100233
14	19,5	51,0	19	36,50	2	009100234
15	20,8	53,5	19	36,50	2	009100235
16	22,0	53,5	19	36,50	2	009100236
17	23,3	54,5	19	36,50	2	009100237
18	24,5	54,5	19	36,50	2	009100238
19	25,8	56,5	19	36,50	2	009100239

910A/AS

hexagon hand sockets



"	Ø	L	Ø1	€	U	PC
1/4	10,3	26	17,3	7,15	5	009100276
5/16	11,9	26	17,3	7,15	5	009100278
11/32	13,3	26	17,3	7,15	5	009100279

"	Ø	L	Ø1	€	U	PC
3/8	13,9	26	17,3	7,15	5	009100280
7/16	15,8	26	17,3	7,15	5	009100281
1/2	17,9	26	17,3	7,35	5	009100283
9/16	19,5	27	18,5	7,35	5	009100284
19/32	20,6	27	19,5	7,35	5	009100285
5/8	21,9	28	20,0	7,90	5	009100286
11/16	24,6	30	22,5	7,90	5	009100287
3/4	25,9	30	23,5	7,90	5	009100289
13/16	27,9	32	26,0	8,95	5	009100291
7/8	29,6	32	26,5	9,25	5	009100292



910A-AS/SB13 € 115,00 U 1 009100295
1/4-5/16-11/32-3/8-7/16
1/2-9/16-19/32-5/8-11/16
3/4-13/16-7/8

910AS

bi-hex hand sockets



"	Ø	L	Ø1	€	U	PC
1/4	9,5	28	16,7	7,15	5	009100201
5/16	12,1	28	16,7	7,15	5	009100202
11/32	13,2	28	16,7	7,15	5	009100203
3/8	14,6	29	16,7	7,15	5	009100204
7/16	15,8	29	16,7	7,15	5	009100205
1/2	18,4	31	17,0	7,35	5	009100206
9/16	19,7	32	17,5	7,35	5	009100207
19/32	20,9	32	18,0	7,35	5	009100208
5/8	22,2	33	18,5	7,90	5	009100209
11/16	24,7	34	20,0	7,90	5	009100210
3/4	25,8	35	21,0	7,90	5	009100211
13/16	28,2	36	23,0	8,95	5	009100212
7/8	29,7	37	24,0	9,25	5	009100213



910AS/SB13 € 115,00 U 1 009100215
1/4-5/16-11/32-3/8-7/16
1/2-9/16-19/32-5/8-11/16
3/4-13/16-7/8

910AS/L

bi-hex hand sockets, long series

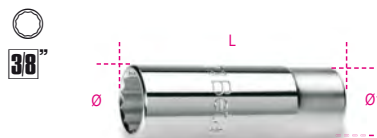

"	Ø	L	Ø1	€	U	PC
1/4	10	55	17	16,20	3	009100350
5/16	12	55	17	16,20	3	009100351
3/8	14	55	17	16,20	3	009100352
7/16	16	55	17	16,20	3	009100353
1/2	18	55	17	17,90	3	009100354
9/16	20	55	18	17,90	3	009100355

"	Ø	L	Ø1	€	U	PC
19/32	21	55	20	18,40	3	009100356
5/8	22	55	20	18,40	3	009100357
11/16	23	55	22	18,40	3	009100359
3/4	25	55	24	19,60	3	009100360
13/16	27	65	26	22,80	3	009100362
7/8	29	65	28	22,80	3	009100363



910ASL/SB12 € 235,50 U 1 009100365
1/4-5/16-3/8-7/16
1/2-9/16-19/32-5/8-11/16
3/4-13/16-7/8

910AS/SN

swivel end bi-hex hand sockets



* SAE AS 954E

"	Ø	L	Ø1	€	U	PC
* 3/8	14,0	48,0	19	36,00	2	009100260
* 7/16	15,8	51,0	19	36,00	2	009100261
* 1/2	18,3	51,0	19	36,00	2	009100262
* 9/16	19,5	51,0	19	36,50	2	009100263
* 5/8	22,0	53,5	19	36,50	2	009100264
11/16	24,5	54,5	19	39,00	2	009100265
3/4	25,8	56,5	19	39,00	2	009100266

910FTX

hand sockets for Torx® head screws



"	Ø	L	Ø1	€	U	PC
E4	6,2	26	17,3	8,55	5	009100404
E5	7,0	26	17,3	8,55	5	009100405
E6	8,3	26	17,3	8,55	5	009100406
E7	8,9	26	17,3	8,55	5	009100407
E8	9,9	26	17,3	8,55	5	009100408
E10	12,0	26	17,3	8,55	5	009100410
E11	13,3	26	17,3	8,55	5	009100411
E12	14,5	26	17,3	8,55	5	009100412
E14	15,8	26	17,3	8,55	5	009100414
E16	18,0	26	17,3	8,55	5	009100416
E18	19,5	26	18,5	9,45	3	009100418
E20	21,9	26	20,0	9,45	3	009100420



910FTX/SB9 € 88,00 U 1 009100430
E4-E5-E6-E7-E8
E10-E12-14-E16

910FTX/L

hand sockets for Torx® head screws, long series



	Ø mm	L mm	Ø1 mm	€		
E4	6,2	55	17,3	19,30	3	009100440
E5	7,0	55	17,3	19,30	3	009100441
E6	8,3	55	17,3	19,30	3	009100442
E7	8,9	55	17,3	19,30	3	009100443
E8	9,9	55	17,3	19,30	3	009100444
E10	12,0	55	17,3	19,30	3	009100445



	€		
910FTX-L/SB6 E4-E5-E6 E7-E8-E10	124,50	1	009100449

910FTX/XL

hexagon hand sockets for Torx® head screws, extra-long series



	Ø mm	L mm	Ø1 mm	€		
E6	8,0	200	18	17,30	2	009100766
E7	8,0	200	18	17,30	2	009100767
E8	10,0	200	18	17,30	2	009100768
E10	14,0	200	18	17,30	2	009100770
E11	14,0	200	18	17,30	2	009100771
E12	14,0	200	18	17,30	2	009100772
E14	17,0	200	18	18,90	2	009100774
E16	18,6	200	18	18,90	2	009100776
E18	21,5	200	18	20,10	2	009100778
E20	21,5	200	18	20,10	2	009100780

910FTX-XL/C10

set of 10 hand sockets for Torx® head screws, long series, in plastic case



	€		
910FTX-XL/C10 E6-E7-E8-E10-E11- E12-E14-E16-E18-E20	182,00	1	009100976

255x195x62 mm - 2,3 kg

910LP

socket drivers for slotted head screws

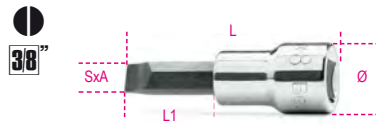

SxA mm	Ø mm	L mm	L1 mm	€		
1x5,5	18,5	54	24	15,10	2	009100452
1,2x6,5	18,5	54	24	15,10	2	009100453
1,2x8	18,5	54	24	15,10	2	009100454
1,6x9	18,5	54	24	15,10	2	009100456

910PH

socket drivers for cross head Phillips® screws



PH	Ø mm	L mm	L1 mm	€		
1	18,5	48	18	14,10	2	009100471
2	18,5	48	18	14,10	2	009100472
3	18,5	48	18	14,10	2	009100473
4	18,5	48	18	14,10	2	009100474



	€		
910PH/SB4 PH1-PH2-PH3-PH4	63,00	1	009100478

910PE

socket drivers for hexagon screws



DIN 7422

mm	Ø mm	L mm	L1 mm	€		
3	18,5	50	20	12,30	5	009100490
4	18,5	50	20	12,30	5	009100492
5	18,5	50	20	12,30	5	009100494
6	18,5	50	20	12,30	5	009100496
7	18,5	50	20	12,30	5	009100497
8	18,5	50	20	12,30	5	009100498
9	18,5	50	20	12,30	5	009100499
10	18,5	50	20	12,30	5	009100500



	€		
910PE/SB7 3-4-5-6-7-8-10 mm	95,50	1	009100503

910BP

ball head socket drivers for hexagon screws



mm	L mm	L1 mm	€		
4L	92	62	14,70	3	009100584
5L	92	62	14,70	3	009100585
6L	92	62	14,70	3	009100586
7L	92	62	14,70	3	009100587
8L	92	62	14,70	3	009100588
10L	132	102	15,90	3	009100590



	€		
910BP/SB6L 4L-5L-6L-7L-8L-10L mm	98,00	1	009100596

910ME

socket drivers for hexagon screws



mm	Ø mm	L mm	L1 mm	€		
4	18	62	15	14,80	5	009100504
5	18	62	15	14,80	5	009100505
6	18	62	15	14,80	5	009100506
7	18	62	15	15,00	5	009100507
8	19	62	15	15,00	5	009100508
10	20	62	15	15,00	5	009100510
12	20	62	15	15,00	5	009100512



	€		
910ME/SB5 4-5-6-8-10 mm	82,00	1	009100515

910PE/AS

socket drivers for hexagon screws



"	Ø mm	L mm	L1 mm	€		
1/8	18,5	50	20	21,10	2	009100531
5/32	18,5	50	20	21,10	2	009100532
3/16	18,5	50	20	21,10	2	009100533
7/32	18,5	50	20	21,10	2	009100534
1/4	18,5	50	20	21,10	2	009100535
5/16	18,5	50	20	21,10	2	009100536
3/8	18,5	50	20	23,40	2	009100537

910PT

socket drivers for 5-star head screws



PT	Ø mm	L mm	L1 mm	€	5	10
PT40	20	50	20	19,60	3	009100540
PT45	20	50	20	20,10	3	009100545
PT50	20	50	20	23,90	3	009100550



910PT/SB8	€	5	10
PT10-PT15-PT20-PT25 PT30-PT40-PT45-PT50	159,50	1	009100558

910TX

socket drivers for Torx® head screws



T	Ø mm	L mm	L1 mm	€	5	10
T15	18,5	50	20	16,20	5	009100519
T20	18,5	50	20	16,20	5	009100520
T25	18,5	50	20	16,20	5	009100521
T27	18,5	50	20	16,20	5	009100522
T30	18,5	50	20	16,20	5	009100523
T40	18,5	50	20	16,20	5	009100524
T45	18,5	50	20	16,20	3	009100525
T50	18,5	50	20	16,20	3	009100526



910TX/SB6	€	5	10
T15-T20-T25 T27-T30-T40	105,50	1	009100530

910XZN

socket drivers with XZN® profile



M	L mm	€	5	10
M4	50	17,30	3	009100559
M5	50	17,30	3	009100560
M6	50	17,30	3	009100561
M8	50	17,30	3	009100563
M10	50	18,40	3	009100565

910CF

3/8" square drive crowfoot wrenches



mm	A mm	L mm	€	5	10
10	21,3	32,3	10,50	2	009100135
11	23,1	34,3	10,50	2	009100136
12	25,5	36,2	11,80	2	009100137
13	26,9	37,4	11,80	2	009100138
14	30,2	40,0	12,50	2	009100139
15	33,3	41,3	13,00	2	009100140
16	33,3	41,3	14,20	2	009100141
17	38,1	46,5	16,50	2	009100142
18	38,1	46,5	16,50	2	009100143
19	39,6	48,0	17,90	2	009100144



910CF/SB10	€	5	10
10-11-12-13-14-15 16-17-18-19 mm	148,00	1	009100147

910/15

adaptor, 3/8" female and 1/4" male drivers



L mm	Ø mm	3/8"	1/4"	€	5	10
30	17,0	□	■	9,05	5	009100810



Always apply torque loads evenly and progressively to avoid breakage and any possible injury.

910/16

adaptor, 3/8" female and 1/2" male drives



L mm	Ø mm	3/8"	1/2"	€	5	10
32	18,0	□	■	9,45	5	009100814



910/20 - 910/21 - 910/22

3/8" drive extension bars

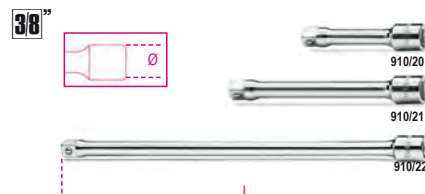

UNI/ISO 3316 DIN 3123	L mm	Ø mm	€	5	10
910/20	75	17	7,75	5	009100820
910/21	125	17	11,20	5	009100822
910/22	250	17	14,80	5	009100826

910AN

3/8" wobble extension bars

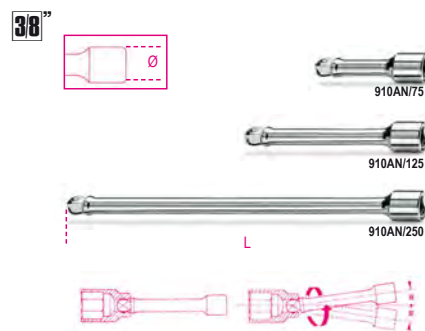

UNI/ISO 3316 DIN 3123	L mm	Ø mm	€	5	10
910AN/75	75	17	11,00	3	009100827
910AN/125	125	17	13,70	3	009100828
910AN/250	250	17	20,60	3	009100829

910/25

3/8" drive universal joint



UNI/ISO 3316 DIN 3123	L mm	Ø mm	€	5	10
910/25	54,6	19	20,30	5	009100830

910M/35

3/8" swivel drive with metal handle



UNI/ISO 3315 DIN 3122	L mm	€	5	10
910M/35	250	56,00	3	009100839

910/36A

3/8" drive swivel handle



UNI/ISO 3315 DIN 3122

L	L1	€	3	009100845
mm	mm			
255	154	39,00		

910/40

3/8" drive swivel T-handle



L	L1	€	3	009100850
mm	mm			
420	175	42,00		

910/42

3/8" drive sliding T-handle

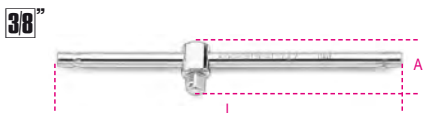

UNI/ISO 3315 DIN 3122

L	A	€	5	009100854
mm	mm			
210	30,5	13,30		

910/46

3/8" square drive with speed brace

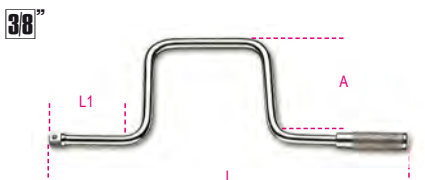

UNI/ISO 3315 DIN 3122

L	L1	A	€	1	009100862
mm	mm	mm			
315	80	115	26,00		

910/55

3/8" drive reversible ratchet 72 teeth



UNI/ISO 3315 DIN 3122

L	Ø	A	€	3	009100882
mm	mm	mm			
200	30	33	47,50		

910/55Q

3/8" drive reversible ratchet 48 teeth



UNI/ISO 3315 DIN 3122

L	Ø	A	€	3	009100885
mm	mm	mm			
200	30	33	47,50		

Spare parts rotating mechanism of ratchets, see table after item 929/C8

910M/55

3/8" drive reversible ratchet with metal handle



DIN 3122 - UNI ISO 3315

L	Ø	A	€	2	009100875
mm	mm	mm			
178	30	26	65,50		

910M/56

3/8" drive reversible swivel ratchet with metal handle



L	Ø	A	€	2	009100887
mm	mm	mm			
265	31	29	89,00		

910/58

3/8" drive reversible ratchet with rotating handle, 52 tooth mechanism

- Socket release button
- Ring nut reversal system on ratchet head
- Bi-material handle



L	Ø	A	€	1	009100884
mm	mm	mm			
222	37	38,5	73,50		

910.../C10

10 sockets and 2 accessories



910A/C10	€	1	009100909
	152,00		

910A	6 - 7 - 8 - 10 - 11 - 12 13 - 14 - 17 - 19 mm
910/21	125 mm
910/55	
270x120x45 mm - 1,3 kg	

910B/C10	€	1	009100910
	152,00		

910B	6 - 7 - 8 - 10 - 11 - 12 13 - 14 - 17 - 19 mm
910/21	125 mm
910/55	
270x120x45 mm - 1,3 kg	

910A/C16...

16 hexagon sockets and 5 accessories



910A/C16	€	1	009100936
	246,50		

910A	6 - 7 - 8 - 9 - 10 - 11 - 12 - 13 14 - 15 - 16 - 17 - 18 - 19 21 - 22 mm
910/21	125 mm
910/22	250 mm
910/25	
910/42	
910/55	
335x145x60 mm - 2,3 kg	

910A/C16Q	€	1	009100932
	246,50		

910A	6 - 7 - 8 - 9 - 10 - 11 - 12 - 13 14 - 15 - 16 - 17 - 18 - 19 21 - 22 mm
910/21	125 mm
910/22	250 mm
910/25	
910/42	
910/55Q	
335x145x60 mm - 2,3 kg	

910B/C16...

16 bi-hex sockets and 5 accessories

38"



910B/C16 € 246,50 1 009100937

- 910B 6 - 7 - 8 - 9 - 10 - 11 - 12 - 13
14 - 15 - 16 - 17 - 18 - 19
21 - 22 mm
 - 910/21 125 mm
 - 910/22 250 mm
 - 910/25
 - 910/42
 - 910/55
- 335x145x60 mm - 2,3 kg

910B/C16Q € 246,50 1 009100933

- 910B 6 - 7 - 8 - 9 - 10 - 11 - 12 - 13
14 - 15 - 16 - 17 - 18 - 19
21 - 22 mm
 - 910/21 125 mm
 - 910/22 250 mm
 - 910/25
 - 910/42
 - 910/55Q
- 335x145x60 mm - 2,3 kg

910A/C17

17 hexagon sockets and 9 accessories

38"



910A/C17 € 369,00 1 009100938

- 910A 6 - 7 - 8 - 9 - 10 - 11 - 12 - 13
14 - 15 - 16 - 17 - 18 - 19 - 20
21 - 22 mm
 - 910/15 □ 3/8 - ■ 1/4
 - 910/16 □ 3/8 - ■ 1/2
 - 910/21 125 mm
 - 910/22 250 mm
 - 910/25
 - 910/36A
 - 910/42
 - 910/46
 - 910/55
- 420x280x60 mm - 4,0 kg

910.../C29

17 sockets, 12 socket drivers
and 5 accessories

38"



910A/C29 € 424,00 1 009100944

- 910A 6 - 7 - 8 - 9 - 10 - 11 - 12 - 13
14 - 15 - 16 - 17 - 18 - 19 - 20
21 - 22 mm
 - 910LP 1x5,5 - 1,2x6,5 - 1,2x8 mm
 - ⊕ 910PH PH1 - PH2 - PH3
 - 910PE 3 - 4 - 5 - 6 - 8 - 10 mm
 - 910/21 125 mm
 - 910/22 250 mm
 - 910/25
 - 910/42
 - 910/55
- 420x185x60 mm - 3,5 kg

910B/C29 € 424,00 1 009100945

- 910B 6 - 7 - 8 - 9 - 10 - 11 - 12 - 13
14 - 15 - 16 - 17 - 18 - 19 - 20
21 - 22 mm
 - 910LP 1x5,5 - 1,2x6,5 - 1,2x8 mm
 - ⊕ 910PH PH1 - PH2 - PH3
 - 910PE 3 - 4 - 5 - 6 - 8 - 10 mm
 - 910/21 125 mm
 - 910/22 250 mm
 - 910/25
 - 910/42
 - 910/55
- 420x185x60 mm - 3,5 kg

910AS/C13...

13 bi-hex sockets and 5 accessories

38"



910AS/C13 € 249,50 1 009100925

- 910AS 1/4 - 5/16 - 11/32 - 3/8 - 7/16
1/2 - 9/16 - 19/32 - 5/8 - 11/16
3/4 - 13/16 - 7/8
 - 910/21 125 mm
 - 910/22 250 mm
 - 910/42
 - 910/25
 - 910/55
- 335x145x60 mm - 2,3 kg

910AS/MBM-C18

13 bi-hex sockets and 5 accessories
for aeronautical maintenance

38"



910AS/MBM-C18 € 261,00 1 009100926

- 910AS 1/4 - 5/16 - 11/32 - 3/8 - 7/16
1/2 - 9/16 - 19/32 - 5/8 - 11/16
3/4 - 13/16 - 7/8
 - 910/21 125 mm
 - 910/22 250 mm
 - 910/25
 - 910/42
 - 910M/55
- 335x145x60 mm - 2,5 kg

910A/C16HR

16 hexagon sockets and 5 accessories

38"



910A/C16HR € 272,00 1 009100935

- 910A 6 - 7 - 8 - 9 - 10 - 11 - 12 - 13
14 - 15 - 16 - 17 - 18 - 19
21 - 22 mm
 - 910/21 125 mm
 - 910/22 250 mm
 - 910/25
 - 910/42 210 mm
 - 910/58
- 335x145x60 mm - 2,4 kg



920A

hexagon hand sockets



UNI/ISO 2725 DIN 3124

Ø mm	Ø mm	L mm	Ø1 mm	€	Hand	Computer
8	12,4	38	21,7	6,05	10	009200008
9	13,5	38	21,7	6,05	10	009200009
10	14,9	38	21,7	6,05	10	009200010
11	16,1	38	21,7	6,05	10	009200011
12	17,5	38	21,7	6,05	10	009200012
13	18,7	38	21,7	6,30	10	009200013
14	20,1	38	21,7	6,30	10	009200014
15	21,5	38	22,5	6,30	10	009200015
16	22,7	38	23,7	7,05	10	009200016
17	24,1	38	23,1	7,05	10	009200017
18	25,3	39	24,0	7,05	10	009200018
19	26,6	39	24,0	7,05	10	009200019
20	27,8	40	25,0	7,65	5	009200020
21	28,8	40	25,0	7,65	5	009200021
22	29,9	41	26,0	7,65	5	009200022
23	30,8	42	26,0	8,90	5	009200023
24	32,2	43	27,0	8,90	5	009200024
25	33,2	44	27,0	8,90	5	009200025
26	34,7	45	28,0	9,25	5	009200026
27	36,2	46	29,0	9,25	5	009200027
28	37,2	47	30,0	9,25	5	009200028
29	38,6	48	31,0	9,65	5	009200029
30	40,2	48	32,0	9,65	5	009200030
32	42,3	49	34,0	10,20	5	009200032



920A/SB13
10-11-12-13-14-15-16
17-18-19-20-21-22 mm

€ 103,50

1 009200040



920A/SB8
23-24-25-26-27-28-30-32 mm

€ 85,00

1 009200042

920MC

hexagon hand sockets,
coloured



Ø mm	Ø mm	L mm	Ø1 mm	€	Hand	Computer
8	13,2	38	22	6,55	5	009202008
10	15,3	38	22	6,55	5	009202010
11	16,5	38	22	6,55	5	009202011
12	17,8	38	22	6,55	5	009202012
13	19,0	38	22	6,90	5	009202013
14	20,3	38	22	6,90	5	009202014
15	21,6	38	22	6,90	5	009202015
16	23,0	38	23	7,65	5	009202016
17	23,9	38	24	7,65	5	009202017
18	25,0	38	25	7,65	5	009202018
19	26,5	38	24	7,65	5	009202019
21	28,8	38	27	8,35	3	009202021
22	29,9	40	28	8,35	3	009202022
24	32,8	40	30	9,70	3	009202024

920B

bi-hex hand sockets



UNI/ISO 2725 DIN 3124

Ø mm	Ø mm	L mm	Ø1 mm	€	Hand	Computer
8	12,4	38	21,7	6,05	10	009200108
9	13,5	38	21,7	6,05	10	009200109
10	14,9	38	21,7	6,05	10	009200110
11	16,1	38	21,7	6,05	10	009200111
12	17,5	38	21,7	6,05	10	009200112
13	18,7	38	21,7	6,30	10	009200113
14	20,1	38	21,7	6,30	10	009200114
15	21,5	38	22,5	6,30	10	009200115
16	22,7	38	23,7	7,05	10	009200116
17	24,1	38	23,1	7,05	10	009200117
18	25,3	39	24,0	7,05	10	009200118
19	26,6	39	24,0	7,05	10	009200119
20	27,8	40	25,0	7,65	5	009200120
21	28,8	40	25,0	7,65	5	009200121
22	29,9	41	26,0	7,65	5	009200122
23	30,8	42	26,0	8,90	5	009200123
24	32,2	43	27,0	8,90	5	009200124
25	33,2	44	27,0	8,90	5	009200125
26	34,7	45	28,0	9,25	5	009200126
27	36,2	46	29,0	9,25	5	009200127
28	37,2	47	30,0	9,25	5	009200128
29	38,6	48	31,0	9,65	5	009200129
30	40,2	48	32,0	9,65	5	009200130
32	42,3	49	33,9	10,20	5	009200132



920B/SB13
10-11-12-13-14-15-16
17-18-19-20-21-22 mm

€ 103,50

1 009200140



920B/SB8
23-24-25-26-27
28-30-32 mm

€ 85,00

1 009200142

920AL

hexagon hand sockets,
long series



UNI/ISO 2725 DIN 3124

Ø mm	Ø mm	L mm	Ø1 mm	€	Hand	Computer
10	14,7	77	21	16,60	5	009200626
12	17,8	77	21	16,60	5	009200627
13	19,0	77	22	16,60	5	009200628
14	20,3	77	22	16,60	5	009200629
15	21,5	77	22	16,60	5	009200630
16	22,8	77	22	17,70	5	009200631
17	24,0	77	23	17,70	5	009200632
18	25,0	77	24	18,70	5	009200633
19	26,5	77	25	18,70	5	009200634
21	29,0	77	27	20,80	5	009200635
22	30,0	77	28	20,80	5	009200636
23	31,5	77	29	20,80	5	009200637
24	32,8	77	30	23,70	5	009200638
27	36,5	77	33	24,80	3	009200639
30	40,0	77	36	30,00	3	009200640
32	42,8	77	38	30,50	3	009200641
36	48,0	77	41	49,00	3	009200642



920AL/SB11
10-12-13-14-15-16
17-18-19-21-22 mm

€ 211,00

1 009200644

920BL

bi-hex hand sockets, long series



UNI/ISO 2725 DIN 3124

Ø mm	Ø mm	L mm	Ø1 mm	€	Hand	Computer
10	14,7	77	21	16,60	5	009200310
12	17,8	77	21	16,60	5	009200312
13	19,0	77	22	16,60	5	009200313
14	20,3	77	22	16,60	5	009200314
15	21,5	77	22	16,60	5	009200315
16	22,8	77	22	17,70	5	009200316
17	24,0	77	23	17,70	5	009200317
18	25,0	77	24	18,70	5	009200318
19	26,5	77	25	18,70	5	009200319
21	29,0	77	27	20,80	5	009200321
22	30,0	77	28	20,80	5	009200322
23	31,5	77	29	20,80	5	009200323
24	32,8	77	30	23,70	5	009200324
27	36,5	77	33	24,80	3	009200327
30	40,0	77	36	30,00	3	009200330
32	42,8	77	38	30,50	3	009200332
36	48,0	77	41	49,00	3	009200336



920BL/SB11
10-12-13-14-15-16-17-18
19-21-22 mm

€ 211,00

1 009200338

920A/AS

hexagon hand sockets



"	Ø mm	L mm	Ø1 mm	€	🔧	📦
3/8	14,6	37	21	7,10	2	009200270
7/16	16,5	37	21	7,10	3	009200272
1/2	19,0	37	22	7,35	3	009200273
9/16	20,3	37	22	7,35	3	009200274
19/32	21,0	37	22	7,90	3	009200275
5/8	22,8	37	22	7,90	3	009200276
11/16	25,0	37	24	8,10	3	009200277
3/4	26,5	38	25	8,10	3	009200279
25/32	28,0	38	26	9,10	3	009200280
13/16	29,0	38	27	9,10	3	009200281
7/8	30,0	40	28	9,10	3	009200282
15/16	32,8	42	30	9,75	3	009200284
1	35,0	42	32	9,75	3	009200285
1.1/16	36,5	43	33	10,70	2	009200287
1.1/8	39,0	43	35	11,00	2	009200289
1.3/16	41,0	46	36	11,80	2	009200290
1.1/4	42,8	46	38	12,00	2	009200292



920A-AS/SB11 € 104,50 1 009200295
3/8-7/16-1/2-9/16-5/8
11/16-3/4-13/16-7/8
15/16-1

920AS

bi-hex hand sockets



"	Ø mm	L mm	Ø1 mm	€	🔧	📦
3/8	14,9	38	21,7	7,10	3	009200201
7/16	16,1	38	21,7	7,10	3	009200202
1/2	18,7	38	21,7	7,35	3	009200203
9/16	20,1	38	21,7	7,35	3	009200204
5/8	22,7	38	22,5	7,90	3	009200206
19/32	21,5	38	23,7	7,90	3	009200207
11/16	25,3	39	24,0	8,10	3	009200208
3/4	26,6	39	24,0	8,10	3	009200209
25/32	27,8	40	25,0	9,10	3	009200210
13/16	28,8	40	25,0	9,10	3	009200211
7/8	29,9	41	26,0	9,10	3	009200212
15/16	32,2	43	27,0	9,75	3	009200214
1	34,2	45	28,0	9,75	3	009200216
1.1/16	36,2	46	29,0	10,70	2	009200217
1.1/8	38,6	48	31,0	11,00	2	009200218
1.3/16	40,2	48	32,0	11,80	2	009200219
1.1/4	42,3	49	33,5	12,00	2	009200220



920AS/SB11 € 104,50 1 009200225
3/8-7/16-1/2-9/16-5/8
11/16-3/4-13/16-7/8
15/16-1

920AS/L

bi-hex hand sockets, long series



"	Ø mm	L mm	Ø1 mm	€	🔧	📦
1/2	19,0	77	22	22,80	2	009200352
9/16	20,3	77	22	22,80	2	009200353
5/8	22,8	77	22	22,80	2	009200355
11/16	25,0	77	24	24,50	2	009200357
3/4	26,5	77	25	25,00	2	009200358
13/16	29,0	77	27	29,50	2	009200360
7/8	30,0	77	28	29,50	2	009200361
15/16	32,8	77	30	30,50	2	009200362
1	35,0	77	32	31,50	2	009200363
1.1/16	36,5	77	33,0	34,50	2	009200364
1.1/8	37,8	77	34	35,50	2	009200365



920ASL/SB11 € 323,00 1 009200369
1/2-9/16-5/8-11/16
3/4-13/16-7/8-15/16
1-1.1/8-1.1/16

920U

gear lock hand sockets



"	Ø mm	Ø1 mm	L mm	€	🔧	📦
10	3/8	E12	M12	38	6,35	5 009201710
11	7/16	E14	M14	38	6,35	5 009201711
12	15/32	E16	38	6,35	5 009201712	
13	1/2	M16	38	6,65	5 009201713	
14	9/16	E18	M18	38	6,65	5 009201714
15	19/32	38	6,65	5 009201715		
16	5/8	E20	38	7,40	5 009201716	
17	38	7,40	5 009201717			
18	E22	38	7,40	5 009201718		
19	3/4	E24	38	7,40	5 009201719	
20	25/32	38	8,15	3 009201720		
21	38	8,15	3 009201721			
22	7/8	38	8,15	3 009201722		
24	15/16	38	9,35	3 009201724		
27	1.1/16	42	9,80	3 009201727		
30	1.1/8	44	10,40	3 009201730		
32	1.1/4	44	10,80	3 009201732		



920U/SB13 € 108,50 1 009201740
10-11-12-13-14-15-16
17-18-19-20-21-22 mm



920U/SB4 € 47,00 1 009201744
24-27-30-32 mm

920FTX

hand sockets for Torx® head screws

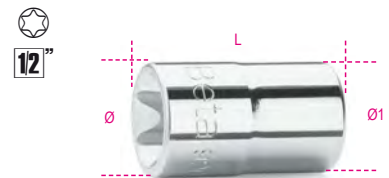

"	Ø mm	L mm	Ø1 mm	€	🔧	📦
E10	13,2	36	21	10,00	5	009200380
E12	15,0	37	21	10,00	5	009200381
E14	16,3	37	21	10,00	5	009200382
E16	18,8	37	22	10,00	5	009200383
E18	20,4	37	22	10,00	5	009200384
E20	22,9	37	22	10,90	5	009200385
E22	25,0	37	24	12,60	3	009200387
E24	26,5	40	25	14,30	3	009200388



920FTX/SB6 € 69,50 1 009200390
E10-E12-E14
E16-E18-E20



920FTX/C8 € 119,00 1 009200391
E10-E12-E14-E16
E18-E20-E22-E24

270X120X45 mm - 1 kg

920FTX/L

hand sockets for Torx® head screws, long series



"	Ø mm	L mm	Ø1 mm	€	🔧	📦
E10	13,2	77	21,0	21,00	5	009200400
E12	15,0	77	21,0	21,00	5	009200401
E14	16,3	77	21,0	21,00	5	009200402
E16	18,8	77	21,8	21,00	3	009200403
E18	20,4	77	21,8	21,00	3	009200404
E20	22,9	77	22,0	21,00	3	009200405



920FTX-LSB6 € 134,50 1 009200409
E10-E12-E14
E16-E18-E20

920LP

socket drivers for slotted head screws

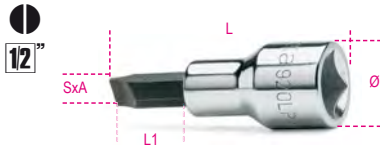

SxA mm	Ø mm	L mm	L1 mm	€	🔧	📄
1x5,5	22,5	62	24	16,40	3	009200452
1,2x6,5	22,5	62	24	16,40	3	009200453
1,2x8	22,5	62	24	16,40	3	009200454
1,6x9	22,5	62	24	16,40	3	009200456
2x12	22,5	62	24	16,40	3	009200458

920PH

socket drivers for cross head Phillips® screws



PH	Ø mm	L mm	L1 mm	€	🔧	📄
1	22,5	56	18	14,40	3	009200471
2	22,5	56	18	14,40	3	009200472
3	22,5	56	18	14,40	3	009200473
4	22,5	56	18	14,40	3	009200474



920PH/SB4 € 64,00 1 009200479
PH1-PH2-PH3-PH4

920LH/SB7

socket drivers for cross head Phillips® screws



920LH/SB7	€	🔧	📄
920LP	118,00	1	009200478
920PH			

920PE

socket drivers for hexagon screws

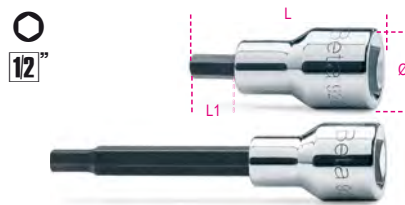

DIN 7422

mm	Ø mm	L mm	L1 mm	€	🔧	📄
3	22,5	58	20	13,00	5	009200410
4	22,5	58	20	13,00	5	009200412
5	22,5	58	20	13,00	5	009200414
5L	22,5	100	62	14,30	5	009200415
6	22,5	58	20	13,00	5	009200417
6L	22,5	100	62	14,30	5	009200418
7	22,5	58	20	13,00	5	009200420
7L	22,5	100	62	14,30	5	009200421
8	22,5	58	20	13,00	5	009200423
8L	22,5	100	62	14,30	5	009200424
9	22,5	58	20	13,00	5	009200425
9L	22,5	140	102	15,00	5	009200426
10	22,5	58	20	13,00	5	009200428
10L	22,5	140	102	15,00	5	009200429
12	23,0	58	20	15,20	5	009200432
12L	22,5	140	102	17,30	5	009200433
14	23,0	58	20	15,20	5	009200434
14L	22,5	140	102	17,30	5	009200435
17	29,5	60	22	18,60	5	009200437
19	29,5	60	22	18,60	5	009200439



920PE/SB9 € 134,00 1 009200441
4-5-6-8-10 mm
5L-6L-8L-10L mm



920PE/C10 € 176,50 1 009200443
4-5-6-7-8-10
12-14-17-19 mm
📏 270X120X45 mm - 🏠 1,5 kg

920PE/AS

socket drivers for hexagon screws



mm	Ø mm	L mm	L1 mm	€	🔧	📄
1/8	22,5	58	20	15,30	2	009200460
3/16	22,5	58	20	15,30	2	009200461
1/4	22,5	58	20	15,30	2	009200463
3/8	22,5	58	20	15,30	2	009200464
1/2	22,5	60	20	16,70	2	009200465
3/4	22,5	60	20	17,90	1	009200468



920PE-AS/SB6 € 104,50 1 009200469
1/8-3/16-1/4-3/8-1/2-3/4

920BP

ball head socket drivers for hexagon screws

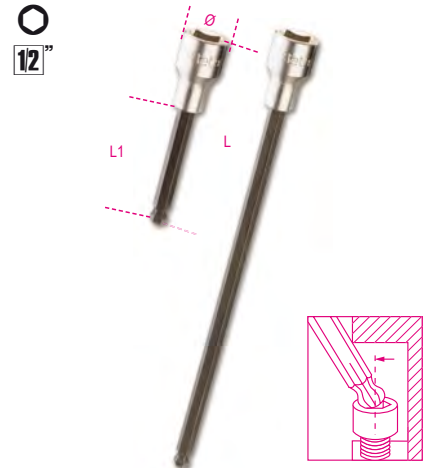

mm	Ø mm	L mm	L1 mm	€	🔧	📄
5L	22,5	100	62	16,50	5	009200490
5XL	22,5	240	202	21,10	1	009200495
6L	22,5	100	62	16,50	5	009200491
6XL	22,5	240	202	21,10	1	009200496
7L	22,5	100	62	16,50	5	009200492
8L	22,5	100	62	16,50	5	009200493
8XL	22,5	240	202	21,10	1	009200497
10L	22,5	140	102	17,90	5	009200494



920BP/SB8 € 158,00 1 009200500
5L-6L-7L-8L-10L mm
5XL-6XL-8XL mm

920ME

socket drivers for hexagon screws



mm	Ø mm	L mm	L1 mm	€	🔧	📄
5	21	75	15,5	15,30	5	009200505
6	21	75	15,5	15,30	5	009200506
7	21	75	15,5	15,30	5	009200507
8	21	75	15,5	15,30	5	009200508
10	23	75	15,5	16,00	5	009200510
12	24	75	15,5	18,40	5	009200512
14	24	75	15,5	18,90	5	009200514
17	24	75	15,5	18,90	5	009200517



12"



920ME/SB7 € 127,50 1 009200519
5-6-8-10-12-14-17 mm

12"



920ME/C7 € 146,50 1 009200518
5-6-8-10-12-14-17 mm
250X100X35 mm - 1,4 kg

920TX

socket drivers for Torx® head screws

12"



⊕	Ø	L	L1	€	1	009200520
T20	mm	mm	mm			
T20	22,5	58	20	16,00	5	009200520
T20L	22,5	120	82	20,50	3	009200530
T25	22,5	58	20	16,00	5	009200521
T25L	22,5	120	82	20,50	3	009200531
T27	22,5	58	20	16,00	5	009200522
T27L	22,5	120	82	20,50	3	009200533
T30	22,5	58	20	16,00	5	009200523
T30L	22,5	120	82	20,50	3	009200534
T40	22,5	58	20	16,00	5	009200524
T40L	22,5	120	82	20,50	3	009200535
T45	22,5	58	20	16,00	5	009200525
T45L	22,5	120	82	20,50	3	009200537
T50	22,5	58	20	16,00	5	009200526
T50L	23,0	140	102	20,50	3	009200538
T55	23,0	58	20	21,40	3	009200527
T55L	23,0	140	102	29,00	3	009200539
T60	23,0	58	20	21,40	3	009200528
T60L	23,0	140	102	29,00	3	009200540
T70L	23,0	120	82	29,00	3	009200541

12"



920TX-SB9 € 166,00 1 009200532
T20-T25-T27-T30
T40-T45-T50-T55-T60



920TX-L/SB10 € 243,00 1 009200545
T20L-T25L-T27L-T30L-T40L-
T45L-T50L-T55L-T60L-T70L

12"



920TX/C9 € 186,00 1 009200546
T20-T25-T27-T30-T40
T45-T50-T55-T60
270X120X45 mm - 1,2 kg

920RTX

socket drivers for Tamper Resistant Torx® head screws

12"



⊕	Ø	L	L1	€	5	009200370
T20	mm	mm	mm			
T20	22,5	58	20	17,00	5	009200370
T25	22,5	58	20	17,00	5	009200371
T27	22,5	58	20	17,00	5	009200372
T30	22,5	58	20	17,00	5	009200373
T40	22,5	58	20	17,00	5	009200374

12"



920RTX/SB5 € 92,50 1 009200378
T20-T25-T27-T30-T40

920XZN

socket drivers with XZN® profile

12"

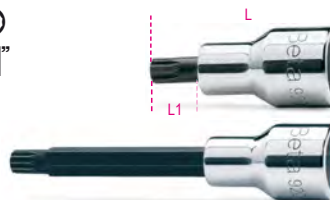

DIN 3324

⊕	Ø	L	L1	€	3	009200559
M4	mm	mm	mm			
M4	22,5	58	20	17,10	3	009200559
M5	22,5	58	20	17,10	3	009200560
M6	22,5	58	20	17,10	3	009200561
M6L	22,5	100	62	19,60	3	009200562
M8	22,5	58	20	17,10	3	009200563
M8L	22,5	100	62	19,60	3	009200564
M9	22,5	58	20	17,10	3	009200582
M9L	22,5	100	62	19,60	3	009200583
M10	22,5	58	20	17,30	3	009200565
M10L	22,5	100	62	19,60	3	009200566
M12	22,5	58	20	17,90	3	009200568
M12L	22,5	100	62	20,10	3	009200569
M14	23,0	58	20	17,90	3	009200571
M14L	23,0	100	62	20,10	3	009200572
M16	23,0	58	20	22,30	3	009200573
M18	23,0	58	20	22,80	3	009200574

12"



920XZN/SB7 € 131,00 1 009200579
M4-M5-M6-M8
M10-M12-M14

12"



920XZN/SB12 € 240,00 1 009200577
M5-M6-M8-M10-M12
M14-M16-M6L-M8L
M10L-M12L-M14L

12"



920XZN-L/S5 € 99,00 1 009200578
M6L-M8L-M10L
M12L-M14L

920ES

special form socket drivers

12"

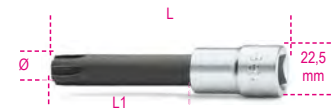

UNI 9326

⊕	Ø	L	L1	€	5	009200587
7XL	mm	mm	mm			
7	(6R)	58	20	23,90	5	009200587
7XL	(6R)	240	202	34,00	1	009200607
9	(8R)	58	20	23,90	5	009200589
9XL	(8R)	240	202	34,00	1	009200609
10	(8S)	58	20	23,90	5	009200590
10XL	(8S)	240	202	34,00	1	009200610
11	(10R)	58	20	23,90	5	009200591
11XL	(10R)	240	202	34,00	1	009200611
12L	(10S)	100	62	27,00	3	009200592
12XL	(10S)	240	202	36,50	1	009200612
14L	(12S)	100	62	27,00	3	009200594
14XL	(12S)	240	202	36,50	1	009200614
16L	(14R)	100	62	27,00	3	009200596
16XL	(14R)	240	202	36,50	1	009200616

12"



920ES/SB7 € 186,00 1 009200598
7-9-10-11-12L-14L-16L

12"



920ES-XL/SB7 € 255,00 1 009200618
7XL-9XL-10XL-11XL
12XL-14XL-16XL

PM 1/2-Q5

12"



PM 1/2-Q5 € 71,504

920/15

adaptor, 1/2" female
and 3/8" male drives



UNI/ISO 3316 DIN 3123

L mm	□	■	∅ mm	€	🔧	📄
42	1/2	3/8	22,0	10,30	5	009200810



Always apply torque loads evenly
and progressively to avoid breakage
and any possible injury.

920/16

adaptor, 1/2" female
and 3/4" male drives



UNI/ISO 3316 DIN 3123

L mm	□	■	∅ mm	€	🔧	📄
46	1/2	3/4	26	13,40	5	009200814

920/20÷920/23

1/2" drive extension bars



UNI/ISO 3316 DIN 3123

	L mm	∅ mm	€	🔧	📄
920/20	75	22	12,50	5	009200818
920/21	125	22	15,30	5	009200822
920/22	255	22	17,30	5	009200826
920/23	375	22	23,20	2	009200827

920AN

1/2" wobble extension bars

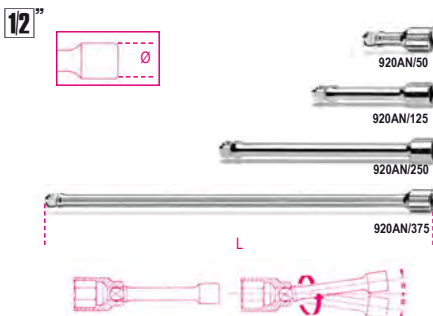

	L mm	∅ mm	€	🔧	📄
920AN/50	50	22	13,40	5	009200833
920AN/125	125	22	18,50	5	009200834
920AN/250	250	22	26,00	3	009200835
920AN/375	375	22	35,00	3	009200836

920/25

1/2" drive universal joint



UNI/ISO 3316 DIN 3123

L mm	∅ mm	€	🔧	📄
75	27	24,50	5	009200830

920/35A

1/2" drive swivel handle

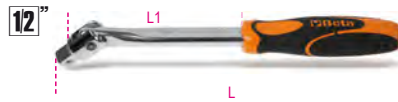

UNI/ISO 3315 DIN 3122

L mm	L1 mm	€	🔧	📄
285	160	48,50	3	009200846

920M/35

1/2" swivel drive with metal handle



UNI/ISO 3315 DIN 3122

L mm	€	🔧	📄
380	69,50	2	009200845

920M/35L

1/2" swivel drive with metal handle, long series



L mm	€	🔧	📄
600	105,50	1	009200843



Always apply torque loads evenly
and progressively to avoid breakage
and any possible injury.

920/36A

1/2" drive swivel handle



UNI/ISO 3315 DIN 3122

L mm	L1 mm	€	🔧	📄
408	283	55,00	2	009200847

920/38

1/2" extension drive swivel handle



L mm	L max mm	€	🔧	📄
262	402	83,00	1	009200839

920/40

1/2" drive swivel T-handle



L mm	L1 mm	€	🔧	📄
490	230	57,00	2	009200850

920/42

1/2" drive sliding T handle

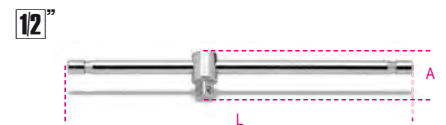

L mm	A mm	€	🔧	📄
305	42	17,10	5	009200854

920/44

1/2" drive offset handle



L mm	L1 mm	€	🔧	📄
230	60	25,50	3	009200858

920/46

1/2" drive with speed brace

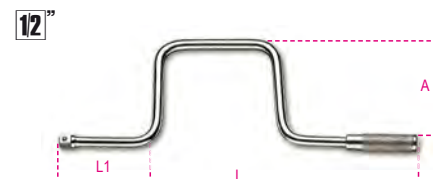

L mm	L1 mm	A mm	€	🔧	📄
385	110	160	31,50	1	009200862

920/50

1/2" push-through drive ratchet,
72 teeth



UNI/ISO 3315 DIN 3122

L	Ø	A	€	3	009200871
mm	mm	mm			
275	40	42	54,50		

920/50F

1/2" female square drive ratchet,
72 teeth



UNI/ISO 3315 DIN 3122

L	Ø	A	€	2	009200889
mm	mm	mm			
275	40	27	50,00		

920/55

1/2" drive reversible ratchet,
72 teeth



UNI/ISO 3315 DIN 3122

L	Ø	A	€	3	009200882
mm	mm	mm			
275	40	43	58,00		

920/55Q

1/2" drive reversible ratchet, 48 teeth



UNI/ISO 3315 DIN 3122

L	Ø	A	€	3	009200885
mm	mm	mm			
275	40	43	58,00		

920/55K

1/2" drive reversible ratchet, 72 teeth



UNI/ISO 3315 DIN 3122

L	Ø	A	€	3	009200895
mm	mm	mm			
200	30	33	49,50		

920/55LC

1/2" drive reversible ratchet
"Locking System", 72 teeth



UNI/ISO 3315 DIN 3122

L	Ø	A	€	2	009200896
mm	mm	mm			
275	40	43	67,00		

920/55L

extension reversible ratchet,
1/2" male drive,
72 tooth mechanism



L	L max	Ø	A	€	1	009200927
mm	mm	mm	mm			
282	422	40	43	101,50		

920M/55

1/2" drive reversible ratchet
with metal handle

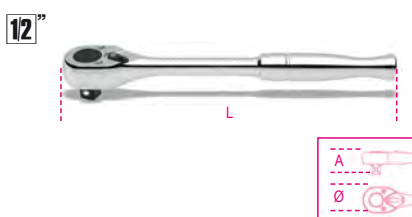

L	Ø	A	€	1	009200893
mm	mm	mm			
253	38	35	75,00		

920/56A

1/2" drive swivel reversible ratchet,
72 teeth



L	Ø	A	€	1	009200911
mm	mm	mm			
315	40	43	95,50		

920M/56

1/2" drive reversible swivel ratchet
with metal handle



L	Ø	A	€	2	009200894
mm	mm	mm			
330	38	35,7	99,50		

920/58

1/2" drive reversible ratchet
with rotating handle,
52 tooth mechanism

- Socket release button
- Ring nut reversal system on ratchet head
- Bi-material handle



L	Ø	A	€	1	009200926
mm	mm	mm			
281	42,5	45	87,00		

Spare parts
rotating mechanism of ratchets,
see table after item 929/C8

920.../C11

11 sockets and 2 accessories

12"



920A/C11 € 182,50 1 009200921

- 920A 10 - 12 - 13 - 14 - 15 - 16
17 - 18 - 19 - 21 - 22 mm
 - 920/22 255 mm
 - 920/50
- ≡ 335x145x60 mm - 2,5 kg

920B/C11 € 182,50 1 009200922

- 920B 10 - 12 - 13 - 14 - 15 - 16
17 - 18 - 19 - 21 - 22 mm
 - 920/22 255 mm
 - 920/50
- ≡ 335x145x60 mm - 2,5 kg

920.../C12...

12 sockets and 5 accessories

12"



920A/C12X € 267,00 1 009200933

- 920A 10 - 11 - 12 - 13 - 14 - 17 - 19
22 - 24 - 27 - 30 - 32 mm
 - 920/21 125 mm
 - 920/22 255 mm
 - 920/25
 - 920/42
 - 920/55
- ≡ 420x185x60 mm - 4,2 kg

920A/C12 € 264,00 1 009200931

- 920A 10 - 11 - 12 - 13 - 14 - 17 - 19
22 - 24 - 27 - 30 - 32 mm
 - 920/21 125 mm
 - 920/22 255 mm
 - 920/25
 - 920/42
 - 920/50
- ≡ 420x185x60 mm - 4,2 kg

920B/C12X € 267,00 1 009200934

- 920B 10 - 11 - 12 - 13 - 14 - 17 - 19
22 - 24 - 27 - 30 - 32 mm
 - 920/21 125 mm
 - 920/22 255 mm
 - 920/25
 - 920/42
 - 920/55
- ≡ 420x185x60 mm - 4,0 kg

920B/C12 € 264,00 1 009200932

- 920B 10 - 11 - 12 - 13 - 14 - 17 - 19
22 - 24 - 27 - 30 - 32 mm
 - 920/21 125 mm
 - 920/22 255 mm
 - 920/25
 - 920/42
 - 920/50
- ≡ 420x185x60 mm - 4,0 kg

920MC/C14

14 coloured hexagon hand sockets and 5 accessories

12"



920MC/C14 € 281,00 1 009202964

- 920MC 8 - 10 - 11 - 12 - 13 - 14 - 15 - 16 - 17
- 18 - 19 - 21 - 22 - 24 mm
 - 920/21 125 mm
 - 920/22 255 mm
 - 920/25
 - 920/42
 - 920/55
- ≡ 420x185x60 mm - 4,2 kg



920.../C20...

20 sockets and 5 accessories

12"



920A/C20X € 330,00 1 009200950

- 920A 10 - 11 - 12 - 13 - 14 - 15 - 16
17 - 18 - 19 - 20 - 21 - 22 - 23
24 - 26 - 27 - 28 - 30 - 32 mm
 - 920/21 125 mm
 - 920/22 255 mm
 - 920/25
 - 920/42
 - 920/55
- ≡ 420x185x60 mm - 5,1 kg

920A/C20 € 327,00 1 009200948

- 920A 10 - 11 - 12 - 13 - 14 - 15 - 16
17 - 18 - 19 - 20 - 21 - 22 - 23
24 - 26 - 27 - 28 - 30 - 32 mm
 - 920/21 125 mm
 - 920/22 255 mm
 - 920/25
 - 920/42
 - 920/50
- ≡ 420x185x60 mm - 5,1 kg

920A/C20Q € 330,00 1 009200955

- 920A 10 - 11 - 12 - 13 - 14 - 15 - 16
17 - 18 - 19 - 20 - 21 - 22 - 23
24 - 26 - 27 - 28 - 30 - 32 mm
 - 920/21 125 mm
 - 920/22 255 mm
 - 920/25
 - 920/42
 - 920/55Q
- ≡ 420x185x60 mm - 5,1 kg

920B/C20 € 327,00 1 009200949

- 920B 10 - 11 - 12 - 13 - 14 - 15 - 16
17 - 18 - 19 - 20 - 21 - 22 - 23
24 - 26 - 27 - 28 - 30 - 32 mm
 - 920/21 125 mm
 - 920/22 255 mm
 - 920/25
 - 920/42
 - 920/50
- ≡ 420x185x60 mm - 5,0 kg

920B/C20X € 330,00 1 009200951

- 920B 10 - 11 - 12 - 13 - 14 - 15 - 16
17 - 18 - 19 - 20 - 21 - 22 - 23
24 - 26 - 27 - 28 - 30 - 32 mm
 - 920/21 125 mm
 - 920/22 255 mm
 - 920/25
 - 920/42
 - 920/55
- 420x185x60 mm - 5,0 kg

920.../C21...

21 sockets and 6 accessories

12"



920A/C21 € 380,00 1 009200952

- 920A 10 - 11 - 12 - 13 - 14 - 15 - 16
17 - 18 - 19 - 20 - 21 - 22 - 23
24 - 25 - 26 - 27 - 28 - 30 - 32 mm
 - 920/21 125 mm
 - 920/22 255 mm
 - 920/25
 - 920/42
 - 920/46
 - 920/50
- 420x280x60 mm - 6,5 kg

920A/C21X € 383,00 1 009200983

- 920A 10 - 11 - 12 - 13 - 14 - 15 - 16
17 - 18 - 19 - 20 - 21 - 22 - 23
24 - 25 - 26 - 27 - 28 - 30 - 32 mm
 - 920/21 125 mm
 - 920/22 255 mm
 - 920/25
 - 920/42
 - 920/46
 - 920/55
- 420x280x60 mm - 6,4 kg

920B/C21 € 380,00 1 009200953

- 920B 10 - 11 - 12 - 13 - 14 - 15 - 16
17 - 18 - 19 - 20 - 21 - 22 - 23
24 - 25 - 26 - 27 - 28 - 30 - 32 mm
 - 920/21 125 mm
 - 920/22 255 mm
 - 920/25
 - 920/42
 - 920/46
 - 920/50
- 420x280x60 mm - 6,4 kg

920B/C21X € 383,00 1 009200984

- 920B 10 - 11 - 12 - 13 - 14 - 15 - 16
17 - 18 - 19 - 20 - 21 - 22 - 23
24 - 25 - 26 - 27 - 28 - 30 - 32 mm
 - 920/21 125 mm
 - 920/22 255 mm
 - 920/25
 - 920/42
 - 920/46
 - 920/55
- 420x280x60 mm - 6,4 kg

920B/C30Q

30 bi-hex sockets and 5 accessories

12"



920B/C30Q € 542,00 1 009200975

- 920B 8 - 9 - 10 - 11 - 12 - 13 - 14
15 - 16 - 17 - 18 - 19 - 20 - 21
22 - 23 - 24 - 26 - 27 - 30 mm
 - 920BL 12 - 13 - 14 - 17 - 19 - 21
22 - 24 - 27 - 30 mm
 - 920/21 125 mm
 - 920/22 255 mm
 - 920/25
 - 920/42
 - 920/55Q
- 420x280x60 mm - 7,6 kg



Beta

920.../C33

20 sockets, 13 socket drivers and 5 accessories

12"



920A/C33 € 531,00 1 009200985

- 920A 10 - 11 - 12 - 13 - 14 - 15 - 16
17 - 18 - 19 - 20 - 21 - 22 - 23
24 - 26 - 27 - 28 - 30 - 32 mm
 - 920LP 1,2x8 - 1,6x9 - 2x12 mm
 - ⊕ 920PH PH2 - PH3 - PH4
 - 920PE 4 - 5 - 6 - 8 - 10 - 12 - 14 mm
 - 920/21 125 mm
 - 920/22 255 mm
 - 920/25
 - 920/42
 - 920/55
- 420x280x60 mm - 6,7 kg

920B/C33 € 531,00 1 009200986

- 920B 10 - 11 - 12 - 13 - 14 - 15 - 16
17 - 18 - 19 - 20 - 21 - 22 - 23
24 - 26 - 27 - 28 - 30 - 32 mm
 - 920LP 1,2x8 - 1,6x9 - 2x12 mm
 - ⊕ 920PH PH2 - PH3 - PH4
 - 920PE 4 - 5 - 6 - 8 - 10 - 12 - 14 mm
 - 920/21 125 mm
 - 920/22 255 mm
 - 920/25
 - 920/42
 - 920/55
- 420x280x60 mm - 6,7 kg

920A/C17M - 920A/C17MR

Assortment of 17 hexagon sockets and 5 accessories in foam tray, in metal case

12"



920A/C17M € 303,00 1 009200924

	920A	10-11-12-13-14-15-16-17-18-19-20-21-22-24-27-30-32 mm
	920/21	125 mm
	920/22	255 mm
	920/25	
	920/42	305 mm
	920/55	
420x185x60 mm - 5 kg		

920A/C17MR € 332,00 1 009200937

	920/21	125 mm
	920/22	255 mm
	920/25	
	920/42	305 mm
	920/58	
420x185x60 mm 5,1 kg		

920/C37

37 bi-hex sockets and 5 accessories

12"



920/C37 € 496,00 1 009200988

	920B	10 - 11 - 12 - 13 - 14 - 15 - 16 17 - 18 - 19 - 20 - 21 - 22 - 23 24 - 26 - 27 - 28 - 30 - 32 mm
	920AS	3/8 - 7/16 - 1/2 - 9/16 - 19/32 5/8 - 11/16 - 3/4 - 25/32 - 13/16 7/8 - 15/16 - 1 - 1.1/16 - 1.1/8 1.3/16 - 1.1/4
	920/21	125 mm
	920/22	255 mm
	920/25	
	920/42	
	920/55	
420x280x60 mm - 7,5 kg		

920AS/C10

10 bi-hex sockets and 2 accessories

12"



920AS/C10 € 188,50 1 009200919

	920AS	3/8 - 7/16 - 1/2 - 9/16 - 5/8 11/16 - 3/4 - 13/16 - 7/8 - 15/16
	920/22	255 mm
	920/50	
335x145x60 mm - 2,6 kg		

920AS/C15

15 bi-hex sockets and 6 accessories

12"



920AS/C15 € 353,00 1 009200947

	920AS	3/8 - 7/16 - 1/2 - 9/16 - 5/8 - 11/16 3/4 - 13/16 - 7/8 - 15/16 - 1 1.1/16 - 1.1/8 - 1.3/16 - 1.1/4
	920/21	125 mm
	920/22	255 mm
	920/25	
	920/42	
	920/46	
	920/50	
420x280x60 mm - 5,9 kg		

Beta

920AS/C17X

17 bi-hex sockets and 5 accessories

12"



920AS/C17X € 330,00 1 009200942

	920AS	3/8 - 7/16 - 1/2 - 9/16 - 19/32 - 5/8 11/16 - 3/4 - 25/32 - 13/16 - 7/8 15/16 - 1 - 1.1/16 - 1.1/8 - 1.3/16 - 1.1/4
	920/21	125 mm
	920/22	255 mm
	920/25	
	920/42	
	920/55	
420x185x60 mm - 4,8 kg		

920AS/MBM-C21

16 bi-hex sockets and 5 accessories for aeronautical maintenance

12"



920AS/MBM-C21 € 336,00 1 009200944

	920AS	3/8 - 7/16 - 1/2 - 9/16 19/32 - 5/8 - 11/16 - 3/4 25/32 - 13/16 - 7/8 - 15/16 1 - 1.1/16 - 1.3/16 - 1.1/4
	920M/55	
	920/21	125 mm
	920/22	255 mm
	920/25	
	920/42	
420x185x60 mm - 5,0 kg		

Beta

920TX/C17

6 bits, 6 sockets, 5 socket drivers and 4 accessories for Torx® head screws



920TX/C17 € 308,00 1 009200989

- 861TX T8 - T10 - T15 - T20 - T25 - T27
- 897
- 920TX T27 - T30 - T40 - T45 - T50
- 920FTX E10 - E12 - E14 - E16 - E18 - E20
- 920/20 75 mm
- 920/22 255 mm
- 920/55

420x185x60 mm - 2,9 kg

920A/C17HR

17 hexagon sockets and 5 accessories in hard foam tray, in metal case

• ratchet with rotating handle



920A/C17HR € 340,00 1 009200939

- 920A 10-11-12-13-14-15-16-17-18-19-20-21-22-24-27-30-32 mm
- 920/21 125 mm
- 920/22 255 mm
- 920/25
- 920/42
- 920/58

420x185x60 mm - 5,1 kg

920U/C17M

17 gear lock hand sockets and 5 accessories, in soft foam tray



920U/C17M € 310,00 1 009201797

- 920U ○ 10-11-12-13-14-15-16-17-18-19-20-21-22-24-27-30-32 mm
* 3/8-7/16-15/32-1/2-9/16-19/32-5/8-3/4-25/32-7/8-15/16-1.1/16-1.1/8-1.1/4
○ M12-M14-M16-M18
○ E12-E14-E16-E18-E20-E22-E24
- 920/21 125 mm
- 920/22 255 mm
- 920/25
- 920/42 305 mm
- 920/55 275 mm

420x185x60 mm - 5 kg

928A

hexagon hand sockets



UNI/ISO 2725
DIN 3124

mm	Ø	L	Ø1	€	U	IT
19	29,2	50	34	15,60	5	009280019
21	30,0	51	34	15,90	5	009280021
22	31,3	53	34	15,90	5	009280022
23	33,3	53	34	16,20	5	009280023
24	34,5	53	34	16,40	5	009280024
26	36,8	55	35	17,50	5	009280026
27	38,0	56	35	17,50	5	009280027
28	39,0	57	35	18,70	3	009280028
29	40,2	58	35	19,00	3	009280029
30	41,5	58	37	19,50	3	009280030
32	44,3	60	37	20,30	3	009280032
33	45,8	60	37	21,20	3	009280033
34	46,8	60	37	21,70	3	009280034
35	48,1	62	38	22,30	3	009280035
36	49,5	64	38	22,30	3	009280036
38	52,0	68	40	24,20	3	009280038
41	56,0	71	40	27,00	3	009280041
46	62,3	75	43	33,50	3	009280046
50	67,4	80	43	40,00	3	009280050
55	73,7	84	48	49,50	1	009280055
60	80,0	87	48	57,00	1	009280060

928B

bi-hex hand sockets



UNI/ISO 2725
DIN 3124

mm	Ø	L	Ø1	€	U	IT
19	29,2	50	34	15,60	5	009280119
21	30,0	51	34	15,90	5	009280121
22	31,3	53	34	15,90	5	009280122
23	33,3	53	34	16,20	5	009280123
24	34,5	53	34	16,40	5	009280124
26	36,8	55	35	17,50	5	009280126
27	38,0	56	35	17,50	5	009280127
28	39,0	57	35	18,70	3	009280128
29	40,2	58	35	19,00	3	009280129
30	41,5	58	37	19,50	3	009280130
32	44,3	60	37	20,30	3	009280132
33	45,8	60	37	21,20	3	009280133
34	46,8	60	37	21,70	3	009280134
35	48,1	62	38	22,30	3	009280135
36	49,5	64	38	22,30	3	009280136
38	52,0	68	40	24,20	3	009280138
41	56,0	71	40	27,00	3	009280141
46	62,3	75	43	33,50	3	009280146
50	67,4	80	43	40,00	3	009280150
55	73,7	84	48	49,50	1	009280155
60	80,0	87	48	57,00	1	009280160

928AS

hexagon hand sockets



mm	Ø	L	Ø1	€	U	IT
7/8	32,0	50	34	17,90	1	009280202
15/16	34,5	53	34	17,90	1	009280203
1	36,2	55	35	18,90	1	009280204
1.1/16	38,0	56	35	19,60	1	009280205
1.1/8	40,2	58	35	20,10	1	009280206
1.1/4	44,2	60	37	21,70	1	009280208
1.5/16	45,8	60	37	22,80	1	009280209
1.3/8	48,1	62	38	23,90	1	009280210
1.7/16	49,5	64	38	25,00	1	009280211
1.1/2	52,0	68	40	27,00	1	009280212
1.5/8	56,0	71	40	29,50	1	009280214
1.11/16	58,8	74	40	34,00	1	009280215
1.13/16	62,3	75	43	37,50	1	009280217
1.7/8	65,0	78	43	40,50	1	009280218
2	68,3	80	43	46,50	1	009280219
2.1/16	71,5	83	48	54,50	1	009280220

928ME

socket drivers for hexagon screws



mm	Ø	L	L1	€	U	IT
14	35	75	15,5	36,00	2	009280514
17	35	75	15,5	36,00	2	009280517
19	35	75	15,5	36,00	2	009280519
22	35	75	22,5	36,00	2	009280522

928/15

adaptor, 3/4" female and 1/2" male drives



UNI/ISO 3316
DIN 3123

L	Ø			€		
mm	mm	□	■			
51,5	34	3/4	1/2	18,90	5	009280801



Always apply torque loads evenly and progressively to avoid breakage and any possible injury.

928/16

adaptor, 3/4" female and 1" male drives



UNI/ISO 3316
DIN 3123

L	Ø			€		
mm	mm	□	■			
65	34	3/4	1"	22,80	5	009280807

928/20 - 928/21 - 928/22

3/4" drive extension bars



UNI/ISO 3316
DIN 3123

	L	Ø	€		
	mm	mm			
928/20	100	34	22,30	3	009280810
928/21	200	34	30,00	3	009280815
928/22	380	34	44,00	3	009280825

928/25

3/4" drive universal joint



UNI/ISO 3316 DIN 3123

L	Ø	€		
mm	mm			
108	40	75,50	1	009280830

928/36A

3/4" drive swivel handle



DIN 3122 - UNI ISO 3315

L	€		
mm			
545	90,00	1	009280844

928/42

3/4" drive slide T-handle

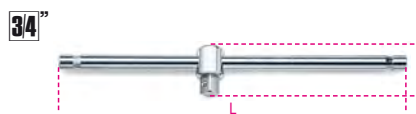

UNI/ISO 3315 DIN 3122

L	A	€		
mm	mm			
450	62,5	47,50	3	009280850

928/55

3/4" drive reversible ratchet, 72 teeth



DIN 3122 - UNI ISO 3315

L	Ø	A	€		
mm	mm	mm			
510	58	59	153,00	2	009280862

Spare parts
rotating mechanism of ratchets,
see table after item 929/C8

928.../C12

assortment of 12 hexagon hand sockets and 5 accessories in sheet metal case



928A/C12	€		
	787,00	1	009280955

928A	22 - 24 - 27 - 30 - 32 - 34 - 36 38 - 41 - 46 - 50 - 55 mm
928/21	200 mm
928/22	380 mm
928/25	
928/42	
928/55	

530x220x80 mm - 13,5 kg

928B/C12	€		
	787,00	1	009280957

928B	22 - 24 - 27 - 30 - 32 - 34 - 36 38 - 41 - 46 - 50 - 55 mm
928/21	200 mm
928/22	380 mm
928/25	
928/42	
928/55	

530x220x80 mm - 13,5 kg

928AS/C12

assortment of 12 hexagon hand sockets and 5 accessories in sheet metal case



928AS/C12	€		
	818,00	1	009280968

928AS	7/8-15/16-1.1/16-1.1/8-1.1/4 1.5/16-1.7/16-1.1/2-1.11/16 1.13/16-1.7/8-2.1/16
928/21	200 mm
928/22	380 mm
928/25	
928/42	
928/55	

530x220x80 mm - 13,5 kg

929

hexagon hand sockets



UNI/ISO 2725 DIN 3124

Ø	Ø	L	Ø1	€	1	009290036
mm	mm	mm	mm			
36	51	65	48	33,50	1	009290036
41	57	70	48	35,50	1	009290041
46	65	75	48	39,00	1	009290046
50	70	80	48	45,50	1	009290050
55	76	85	54	53,50	1	009290055
60	82	90	54	57,00	1	009290060
65	88	95	54	73,50	1	009290065
70	92	100	60	87,50	1	009290070
75	99	110	60	95,50	1	009290075
80	106	120	60	109,00	1	009290080

929/15

adaptor, 1" female and 3/4" male drives

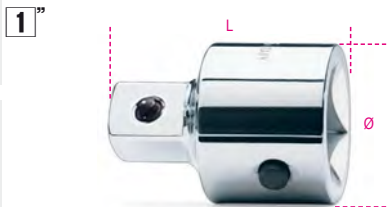

UNI/ISO 3316 DIN 3123

L	Ø	□	■	€	2	009290801
mm	mm	1"	3/4"			
65	47	1"	3/4"	39,00	2	009290801



Always apply torque loads evenly and progressively to avoid breakage and any possible injury.

929/21 - 929/22

1" drive extension bars



UNI/ISO 3316 DIN 3123

	L	Ø	€	1	009290815
	mm	mm			
929/21	200	47	50,50	1	009290815
929/22	400	47	73,50	1	009290825

929/42

1" drive slide T-handle

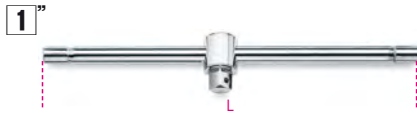

UNI/ISO 3315 DIN 3122

L	€	1	009290850
mm			
535	94,50	1	009290850

929/55

1" reversible ratchet 72 teeth



UNI/ISO 3315 DIN 3122

L	Ø	A	€	1	009290860
mm	mm	mm			
770	62	63	203,00	1	009290860

929/55PR

extension bars for ratchets 929/55



L	Ø	Ø1	€	1	009290868
mm	mm	mm			
540	32	26	43,50	1	009290868

929/C8

8 hexagon sockets and 5 accessories



929/C8	€	1	009290925
	1.191,00	1	009290925

- 929 46 - 50 - 55 - 60 - 65
70 - 75 - 80 mm
- 929/15 1" - ■ 3/4"
- 929/21 200 mm
- 929/22 400 mm
- 929/42
- ⊗ 929/55

560x290x120 mm - 29 kg

900/R55



900/R55	€	1	009000871
666N/2-900/55	33,50	1	009000871

900/R55-Z



900/R55-Z	€	1	009000872
	33,50	1	009000872

900M/R55



900M/R55	€	1	009000888
900M/55	17,30	1	009000888

910/R55



910/R55	€	1	009100879
599DGT/6-606/6-606/10-612 665/6-665/10-665LB/6-665LB/10 666N/5-666N/10-666N LBF.IN/5- 666N LBF.IN/10 666/6-666/10-668RGC/6- 668RGC/10-910/55	32,50	1	009100879

910M/R55



910M/R55	€	1	009100888
910M/55-910M/56	17,90	1	009100888

910/R55Q



910/R55Q	€	1	009100877
910/55Q	32,50	1	009100877

910/R55X



910/R55X
666N/2X € 32,50 1 009100897

920/R50



920/R50
614/50-667/20-667/30
920/50 € 32,00 1 009200866

920/R55



920/R55 € 38,50 1 009200879
606/20-606/30-666/20-666/30
920/55-920/56A- 599DGT/20-
599DGT/30-599DGT-AN/20
665/20-665/30-665LB/20-665LB/30
666N/20-666N/30-666N LBF.IN/20-
666N LBF.IN/30
668RGC/20

920M/R55



920M/R55 € 20,10 1 009200888
920M/55-920M/56

920/R55Q



920/R55Q € 38,50 1 009200877
920/55Q

920/R55X



920/R55X € 32,00 1 009200878
606/10X-612X
666/10X-920/55X-599DGT/10X-599DGT-
AN/10
665/10X-665LB/10X-666N10X-
666N LBF.IN/10X
668RGC/10X

920/R55LC



920/R55LC € 40,50 1 009200887
920/55LC "Locking System"

928/R55



928/R55 € 64,50 1 009280859
928/55

928/R55X



928/R55X € 41,00 1 009280858
614X

929/R55



929/R55 € 74,50 1 009290859
929/55

930

double ended bi-hex tubular socket wrenches,
heavy series



UNI 6745

Ø	L	Ø	Ø1	€	1	3
mm	mm	mm	mm			
6x7	100	9,5	11,0	12,50	3	009300006
8x9	108	12,5	14,0	15,70	3	009300010
10x11	116	15,0	16,5	16,50	3	009300014
12x13	124	17,5	19,0	19,30	3	009300018
14x15	132	20,0	21,5	21,00	3	009300023
16x17	140	23,0	24,0	24,20	3	009300027
18x19	148	25,0	26,5	27,00	3	009300032
20x22	156	28,0	30,0	29,50	2	009300036
21x23	163	29,0	31,5	31,50	2	009300040
24x26	173	33,0	35,5	40,00	2	009300044
25x28	182	34,5	38,0	43,50	2	009300048
27x29	191	37,0	39,5	49,50	2	009300052
30x32	200	40,5	43,0	60,00	2	009300056



930/S8 € 178,00 1 009300081

6x7-8x9-10x11
12x13-14x15-16x17
18x19-20x22 mm

940/1 - /2

930/S13 € 415,00 1 009300083

6x7-8x9-10x11-12x13
14x15-16x17-18x19
20x22-21x23-24x26
25x28-27x29-30x32 mm

940/1 - /2 - /3



930/C13 € 467,00 1 009300098

6x7-8x9-10x11-12x13
14x15-16x17-18x19
20x22-21x23-24x26
25x28-27x29-30x32 mm

940/1 - /2 - /3

932

double ended hexagon / bi-hex offset
socket wrenches, bright chrome-plated

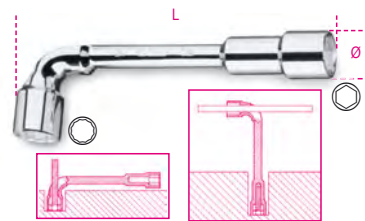

NF E 74.303

Ø	Ø	L	€	1	5
mm	mm	mm			
6x6	11,5	110	14,00	5	009320006
7x7	12,5	116	14,20	5	009320007
8x8	13,0	120	14,80	5	009320008
9x9	14,0	125	15,30	5	009320009
10x10	16,5	133	15,90	5	009320010
11x11	17,5	143	17,30	5	009320011
12x12	19,0	148	18,50	5	009320012
13x13	19,5	154	19,20	5	009320013
14x14	21,5	167	20,30	5	009320014
15x15	22,5	182	21,40	5	009320015
16x16	24,5	193	22,30	5	009320016
17x17	26,0	198	22,50	5	009320017
18x18	26,5	215	24,60	5	009320018
19x19	29,0	220	27,00	5	009320019
20x20	30,5	222	28,50	3	009320020
21x21	30,5	236	33,00	3	009320021
22x22	32,5	250	36,00	2	009320022
23x23	33,5	256	40,00	2	009320023
24x24	35,0	272	43,00	2	009320024
25x25	36,5	282	45,50	2	009320025
26x26	37,5	296	50,00	2	009320026
27x27	39,0	296	52,50	2	009320027
28x28	39,0	314	59,50	2	009320028
30x30	42,5	348	71,00	2	009320030
32x32	45,5	364	78,50	2	009320032

Beta
Quality Tools



932/S11	€ 219,50	1	009320080
6-7-8-10-11-12 13-14-17-19-22 mm			
932/S17	€ 365,00	1	009320081
6-7-8-9-10-11-12 13-14-15-16-17 18-19-20-21-22 mm			
932/S25	€ 805,00	1	009320082
6-7-8-9-10-11-12-13 14-15-16-17-18-19 20-21-22-23-24-25 26-27-28-30-32 mm			

933

double ended offset hexagon socket wrenches, bright chrome-plated

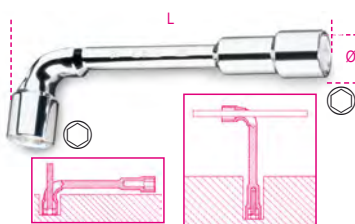

NF E 74.303

mm	Ø mm	L mm	€	1	009330006
6x6	11,5	110	14,00	5	009330006
7x7	12,5	116	14,20	5	009330007
8x8	13,0	120	14,80	5	009330008
9x9	14,0	125	15,30	5	009330009
10x10	16,5	133	15,90	5	009330010
11x11	17,5	143	17,30	5	009330011
12x12	19,0	148	18,50	5	009330012
13x13	19,5	154	19,20	5	009330013
14x14	21,5	167	20,30	5	009330014
15x15	22,5	182	21,40	5	009330015
16x16	24,5	193	22,30	5	009330016
17x17	26,0	198	22,50	5	009330017
18x18	26,5	215	24,60	5	009330018
19x19	29,0	220	27,00	5	009330019
20x20	30,5	222	28,50	3	009330020
21x21	30,5	236	33,00	3	009330021
22x22	32,5	250	36,00	2	009330022
23x23	33,5	256	40,00	2	009330023
24x24	35,0	272	43,00	2	009330024
25x25	36,5	282	45,50	2	009330025
26x26	37,5	296	50,00	2	009330026
27x27	39,0	296	52,50	2	009330027
28x28	39,0	314	59,50	2	009330028
30x30	42,5	348	71,00	2	009330030
32x32	45,5	364	78,50	2	009330032



933/S11	€ 219,50	1	009330080
6-7-8-10-11-12 13-14-17-19-22 mm			
933/S17	€ 365,00	1	009330081
6-7-8-9-10-11-12 13-14-15-16-17 18-19-20-21-22 mm			
933/S25	€ 805,00	1	009330082
6-7-8-9-10-11-12-13 14-15-16-17-18-19 20-21-22-23-24-25 26-27-28-30-32 mm			

935

double ended hexagon tubular socket wrenches, light series



UNI 6746 DIN 896

mm	L mm	€	5	009350105
6x7	100	7,25	5	009350105
8x9	110	7,75	5	009350111
10x11	120	8,65	5	009350115
12x13	130	9,85	5	009350117
14x15	140	11,40	5	009350126
16x17	150	12,50	5	009350128
18x19	160	14,80	5	009350131
20x22	170	17,90	3	009350138
21x23	180	19,90	3	009350141
24x26	190	22,60	3	009350144
25x28	200	25,00	2	009350150
27x29	210	29,00	2	009350153
30x32	220	31,50	2	009350156



935/S8	€ 102,50	1	009350181
6x7-8x9-10x11 12x13-14x15-16x17 18x19-20x22 mm			
940/1 - /2			
935/S13	€ 243,50	1	009350183
6x7-8x9-10x11 12x13-14x15-16x17 18x19-20x22-21x23 24x26-25x28-27x29 30x32 mm			
940/1 - /2 - /3			

937

double ended hexagon / bi-hex socket wrenches, chrome-plated

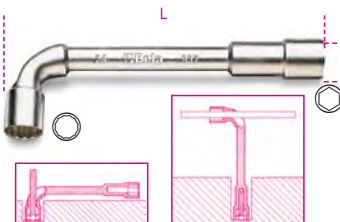

mm	Ø mm	L mm	€	5	009370006
6x6	11,5	110	7,75	5	009370006
7x7	12,5	116	8,10	5	009370007
8x8	13,0	120	8,45	5	009370008
9x9	14,0	125	8,95	5	009370009
10x10	16,5	133	9,35	5	009370010
11x11	17,5	143	9,85	5	009370011
12x12	19,0	148	10,90	5	009370012
13x13	19,5	154	11,20	5	009370013
14x14	21,5	167	12,30	5	009370014
15x15	22,5	182	13,60	5	009370015
16x16	24,5	193	14,70	5	009370016
17x17	26,0	198	15,20	5	009370017
18x18	26,5	215	15,50	5	009370018
19x19	29,0	220	16,20	5	009370019
20x20	30,5	222	18,40	3	009370020
21x21	30,5	236	20,10	3	009370021
22x22	32,5	250	21,10	2	009370022
23x23	33,5	256	23,40	2	009370023
24x24	35,0	272	24,50	2	009370024
25x25	36,5	282	31,00	2	009370025
26x26	37,5	296	32,00	2	009370026
27x27	39,0	296	32,50	2	009370027
28x28	39,0	314	39,00	2	009370028
30x30	42,5	348	42,00	2	009370030
32x32	45,5	364	47,00	2	009370032



937/S11	€ 130,50	1	009370080
6-7-8-10-11-12 13-14-17-19-22 mm			
937/S17	€ 221,50	1	009370081
6-7-8-9-10-11-12 13-14-15-16-17 18-19-20-21-22 mm			

940

tommy bars for tubular wrenches items 930 and 935



	mm	L mm	€	5	009400001
940/1	6+13	100	5,40	5	009400001
940/2	14+22	170	7,05	5	009400002
940/3	21+32	290	12,80	5	009400003

941

hexagon / bi-hex socket wrenches, with high torque handles

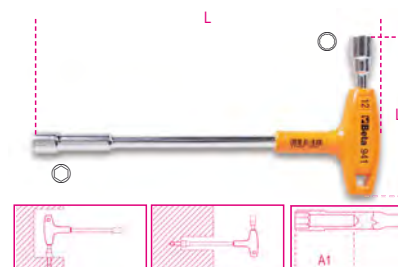

mm	L mm	L1 mm	A1 mm	€	2	009410107
7x7	200	91	35	26,00	2	009410107
8x8	220	107	50	28,50	2	009410108
9x9	220	109	50	28,50	2	009410109
10x10	236	111	50	29,00	2	009410110
11x11	236	114	50	30,50	2	009410111
12x12	255	122	50	34,00	2	009410112
13x13	255	124	55	34,50	2	009410113



941/S7	€ 211,00	1	009410170
7-8-9-10-11-12-13 mm			

NUT SPINNERS WITH HANDLES

Suitable for quick, repeated screwing operations. The reduced thickness of the hexagons allows access to small spaces.

The interior exhaust hole makes it easier to work on nuts with projecting threaded parts. This is the case, in particular with deep, hi-torque nut spinners 944BX and 949.

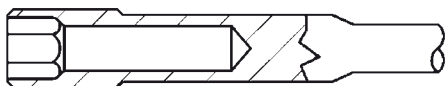

The triple marking on the head makes it easier to identify the required size.

The flexible blade of model 943FL, which is made up of a steel core protected by a sheath, allows torque transmission in case of misalignment with the screw.

942BX

hi-torque hexagon nut spinners short series



UNI 6750

mm	L mm	L1 mm	A1 mm	€	Hand	Computer
4	190	70	13,0	13,00	5	009420003
5	190	70	14,0	13,00	5	009420004
5,5	190	70	12,5	14,80	5	009420005
6	190	70	14,5	14,80	5	009420006
7	190	70	15,5	15,40	5	009420007
8	202	70	18,5	15,40	5	009420008
9	202	70	19,5	15,40	5	009420009
10	202	70	20,5	16,50	3	009420010
11	202	70	21,5	16,50	3	009420011
12	202	70	22,5	16,50	3	009420012
13	202	70	23,5	18,60	3	009420013
14	202	70	24,5	18,60	3	009420014



942BX/S12 € 188,50 1 009420030
4-5-5,5-6-7-8-9
10-11-12-13-14 mm

943BX

hi-torque hexagon nut spinners long series



ISO 2236 UNI 6750

mm	L mm	L1 mm	A1 mm	€	Hand	Computer
4	270	150	13,0	14,50	5	009430003
5	270	150	14,0	14,50	5	009430004
5,5	270	150	12,5	15,50	5	009430005
6	270	150	14,5	15,50	5	009430006
7	270	150	15,5	16,70	5	009430007
8	282	150	18,5	16,70	5	009430008
9	282	150	19,5	16,70	5	009430009
10	282	150	20,5	18,20	3	009430010
11	282	150	21,5	18,20	3	009430011
12	282	150	22,5	18,20	3	009430012
13	282	150	23,5	19,30	3	009430013
14	282	150	24,5	19,30	3	009430014



943BX/S12 € 203,50 1 009430030
4-5-5,5-6-7-8-9
10-11-12-13-14 mm



943BX/D6 € 101,00 1 009430026
5-6-7-8-10-13 mm

943FL

flexible hexagon nut spinners with handles



mm	L mm	L1 mm	Ø mm	€	Hand	Computer
5	265	150	8	20,40	2	009430304
5,5	265	150	8	20,40	2	009430305
6	265	150	9	20,40	2	009430306
7	265	150	11	20,40	2	009430307
8	265	150	12	21,10	2	009430308
10	290	175	14	22,80	2	009430310



943FL/S6 € 125,50 1 009430320
5-5,5-6-7-8-10 mm

944BX

deep, hi-torque hexagon nut spinners long series



ISO 2236 UNI 6750

mm	L mm	L1 mm	A1 mm	€	Hand	Computer
4	245	125	20	15,00	3	009440003
5	245	125	25	15,00	3	009440004
5,5	245	125	30	18,40	3	009440005
6	245	125	35	18,40	3	009440006
7	245	125	35	18,40	3	009440007
8	257	125	50	19,80	3	009440008
9	257	125	50	19,80	3	009440009
10	257	125	50	20,60	3	009440010
11	257	125	50	20,60	3	009440011
12	257	125	50	22,60	3	009440012
13	257	125	55	22,60	3	009440013
14	257	125	55	22,60	3	009440014



944BX/S12 € 234,00 1 009440062
4-5-5,5-6-7-8-9
10-11-12-13-14 mm



944BX/D6 € 115,00 1 009440056
5-6-7-8-10-13 mm

949

deep T-handle socket wrenches

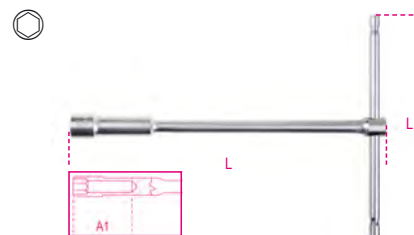

mm	L mm	L1 mm	A1 mm	€	Hand	Computer
8	220	160	50	27,50	2	009490008
10	230	160	50	28,50	2	009490010
12	240	175	50	29,50	2	009490012
13	244	175	55	30,50	2	009490013
14	250	190	55	32,50	2	009490014
17	264	200	60	37,00	2	009490017



949/S6 € 185,50 1 009490076
8-10-12-13-14-17mm

950

T-handle hexagon socket wrenches

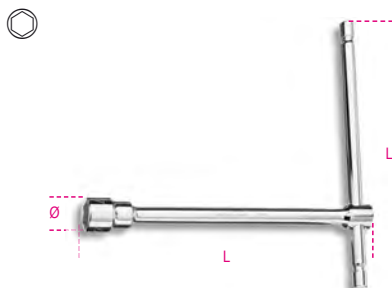

UNI 6742 DIN 3112

mm	L mm	Ø mm	L1 mm	€	U	PC
6	210	10,1	145	18,90	3	009500006
7	212	11,2	145	18,90	3	009500007
8	220	12,4	160	20,40	3	009500008
9	223	13,5	160	20,40	3	009500009
10	230	14,9	160	22,10	3	009500010
11	233	16,1	160	22,10	3	009500011
12	240	17,5	175	24,50	3	009500012
13	244	19,7	175	24,50	3	009500013
14	250	20,1	190	27,50	3	009500014
15	254	21,5	190	28,50	3	009500015
16	260	22,7	200	31,50	3	009500016
17	264	24,1	200	32,50	3	009500017
19	274	26,6	230	40,00	3	009500019
22	290	29,9	290	48,00	2	009500022
24	300	32,2	320	54,50	2	009500024
27	315	36,2	370	64,50	2	009500027



950/S9 € 232,50 1 009500079
7-8-10-11-12
13-14-17-19 mm

950/S14 € 380,00 1 009500082
6-7-8-9-10-11-12-13
14-15-16-17-19-22 mm

951 T-HANDLE WRENCHES WITH THREE HEXAGON MALE ENDS



When this wrench was launched, back in 1980, it was a revolution.

Designed to work on high-resistance screws, it is the name for quick handling, accurate fit and flexible use.

The hexagon T handle can be adjusted as required.

The hexagon ends are designed to transmit the maximum possible torque to the screw.

The rod length allows remarkable torques to be effortlessly applied to the screws.

Ongoing production improvements have translated, for example, into sandblasted finishes and sharp-edged hexagon ends which allow a better fit onto any screws, including damaged ones.

Laser marking results in a sturdier rod.

951

T-handle wrenches with three hexagon male ends

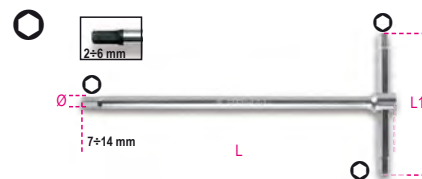

mm	L mm	L1 mm	Ø mm	€	U	PC
2	125	63	4,0	17,30	5	009510521
2,5	150	63	4,0	17,30	5	009510525
3	150	63	4,0	17,30	5	009510530
3,5	175	76	5,5	17,90	5	009510535
4	175	76	5,5	17,90	5	009510540
4,5	195	87	6,5	19,60	5	009510545
5	195	87	6,5	19,60	5	009510550
6	215	99	8,0	22,60	5	009510560
7	230	109	9,0	24,50	5	009510570
8	250	122	10,0	24,50	5	009510580
9	265	132	11,0	30,50	5	009510590
10	280	142	12,0	30,50	5	009510610
12	305	160	15,0	41,50	3	009510620
14	330	178	17,0	49,50	3	009510640



951/S6 € 119,00 1 009510687
2,5-3-4-5-6-8 mm

951/S8 € 149,50 1 009510693
2-2,5-3-3,5-4-4,5-5-6 mm

951/S14 € 350,00 1 009510695
2-2,5-3-3,5-4-4,5
5-6-7-8-9-10-12-14 mm



951/SP6 € 151,50 1 009510696
3-4-5-6-8-10 mm

951/SPV € 28,00 1 009510697

951AS

T-handle wrenches with three hexagon male ends

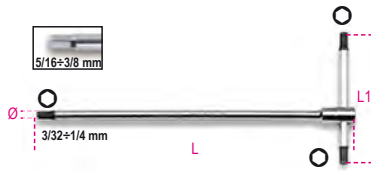

"	L mm	L1 mm	Ø mm	€	🔧	📄
3/32	125	63	4,0	23,20	2	009510750
7/64	150	63	4,0	23,20	2	009510751
1/8	150	63	4,0	23,20	2	009510752
9/64	175	76	5,5	24,30	2	009510753
5/32	175	76	5,5	24,30	2	009510754
3/16	195	86	6,5	26,50	2	009510755
7/32	215	99	8,0	26,50	2	009510757
1/4	230	109	9,0	30,00	2	009510758
5/16	250	122	10,0	30,50	2	009510759
3/8	280	142	12,0	37,00	2	009510760



951AS/S6X 173,50 1 009510771
1/8-3/16-7/32-1/4-5/16-3/8

951TX

T-handle wrenches with three male ends for Torx® head screws



⊕	L mm	L1 mm	Ø mm	€	🔧	📄
T6	125	63	4	21,50	3	009510806
T7	125	63	4	21,50	3	009510807
T8	125	63	4	22,10	3	009510808
T9	125	63	4	22,10	3	009510809
T10	150	63	4	22,60	3	009510810
T15	150	63	4	22,60	3	009510815
T20	175	76	5	23,70	3	009510820
T25	175	76	5	23,70	3	009510825
T27	195	87	6	25,50	3	009510827
T30	195	87	6	25,50	3	009510830
T40	215	99	7	29,00	3	009510840
T45	230	109	8	31,00	3	009510845
T50	250	122	9	33,50	3	009510850



951TX/S6 140,00 1 009510866
T8-T10-T15-T20-T25-T30
951TX/S13 324,00 1 009510863
T6-T7-T8-T9-T10-T15-T20-T25
T27-T30-T40-T45-T50

952 T-HANDLE WRENCHES WITH SWIVELLING HEXAGON SOCKETS

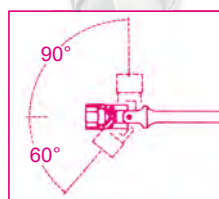

Reliable, precise pre-positioning is the secret for the success of this wrench.

The articulated joint maintains its function over the years, no adjustment being required.

Socket rotation angle: 60°. Can be used at 90° in fixed position.

Sliding T-handle, can be stopped in the required position throughout its length.

Triple size marking on head.

952

T-handle wrenches with swivelling hexagon sockets

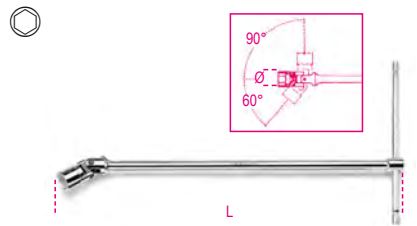

UNI 6743

⊕ mm	Ø mm	L mm	€	🔧	📄
6	9,5	395	29,00	5	009520006
7	10,7	395	29,00	5	009520007
8	12,1	395	29,00	5	009520008
9	13,2	395	29,00	5	009520009
10	14,6	400	31,50	5	009520010
11	15,8	400	31,50	5	009520011
12	17,0	400	31,50	5	009520012
13	18,7	432	34,00	5	009520013
14	19,7	432	34,00	5	009520014
15	20,9	450	41,50	3	009520015
16	22,0	450	41,50	3	009520016
17	23,4	450	41,50	3	009520017
18	24,7	450	41,50	3	009520018
19	26,0	500	50,50	3	009520019
20	27,4	500	50,50	3	009520020
21	28,5	500	50,50	3	009520021
22	29,7	500	50,50	3	009520022
24	32,4	500	50,50	3	009520024



952/S7 252,00 1 009520074
8-10-11-13-14-17-19 mm
952/S10 354,00 1 009520080
7-8-10-11-12-13-14-15-17-19 mm
952/S18 697,00 1 009520083
6-7-8-9-10-11-12-13-14-15-16-17-18-19-20-21-22-24 mm

852



852

76,82



952AS

T-handle wrenches with swivelling hexagon sockets

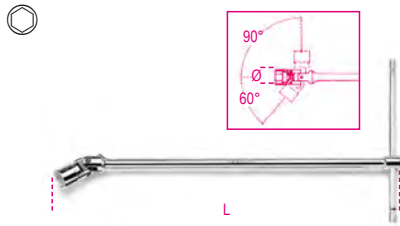

mm	Ø mm	L mm	€	W	U
1/4	9,5	395	32,00	2	009520256
5/16	12,1	395	32,00	2	009520258
3/8	14,6	400	34,50	2	009520260
7/16	15,8	400	34,50	2	009520261
1/2	18,7	432	38,50	2	009520263
9/16	19,7	432	41,50	2	009520264
5/8	22,0	450	44,50	2	009520266
11/16	23,4	450	44,50	2	009520267
3/4	26,0	500	55,00	2	009520269

952L

T-handle wrenches with swivelling hexagon sockets, long series

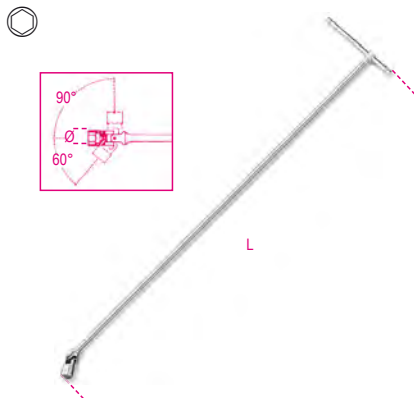

mm	Ø mm	L mm	€	W	U
10	14,6	930	80,00	1	009520410
12	17,0	1063	80,00	1	009520412
13	18,7	1100	80,00	1	009520413
14	19,7	1100	80,00	1	009520414
15	20,9	1100	90,00	1	009520415
16	22,0	1100	90,00	1	009520416
17	23,4	1100	90,00	1	009520417
18	24,7	1100	90,00	1	009520418
19	26,0	1100	104,50	1	009520419

952FTX

T-handle wrenches with swivelling socket, for Torx® head screws

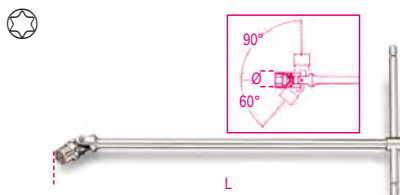

mm	Ø mm	L mm	€	W	U
E6	8	392	34,50	2	009520106
E7	9	392	34,50	2	009520107
E8	10	395	39,50	2	009520108
E10	13	400	40,50	2	009520110
E12	15	440	48,50	2	009520112
E14	17	490	59,50	2	009520114
E16	19	490	59,50	2	009520116
E18	21	490	59,50	2	009520118
E20	23	490	59,50	2	009520120



mm	Ø mm	L mm	€	W	U
952FTX/S9	E6-E7-E8-E10-E12	E14-E16-E18-E20	435,00	1	009520141

953

T-handle wrenches with swivelling hexagon male ends

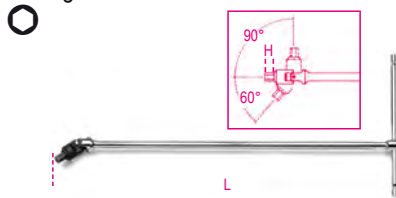

UNI 6754

mm	H mm	L mm	€	W	U
3	5	395	30,00	5	009530130
3,5	6	395	30,00	3	009530135
4	6	395	30,00	5	009530140
4,5	7	395	30,00	3	009530145
5	7	395	30,00	5	009530150
6	9	400	32,50	5	009530160
7	10	425	36,00	3	009530170
8	11	425	36,00	5	009530180
10	13	440	43,00	5	009530200



mm	€	W	U
953/S5 3-4-5-6-8 mm	158,50	1	009530305
953/S9 3-3,5-4-4,5 5-6-7-8-10 mm	297,00	1	009530301

953TX

T-handle wrenches with swivelling end for Torx® head screws

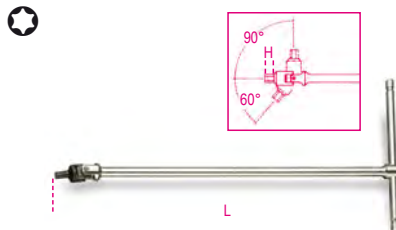

mm	H mm	L mm	€	W	U
T20	11	396	36,50	2	009530020
T25	11	396	36,50	2	009530025
T27	11	396	36,50	2	009530027
T30	13	400	40,50	2	009530030
T40	13	400	40,50	2	009530040
T45	13	426	41,50	2	009530045
T50	14	442	48,50	2	009530050
T55	14	442	49,00	2	009530055



mm	€	W	U
953TX/S8 T20-T25-T27-T30 T40-T45-T50-T55	329,00	1	009530060

VEHICLE REPAIR

Our vehicle repair tools, which are used by the most demanding professionals, are developed and manufactured to meet the world's highest standards, and regularly tested under the most stressful operating conditions.

For over 50 years, we have been proudly working hand in hand with the greatest champions, who help us improve our products non-stop and provide testimony to the highest quality standard.

The vehicle repair tools are found in these sections:

Diagnostics	items 1438 to 1499 items 1758VT to 1760TMC
Engine	items 955 to 989A items 1438 to 1499
Oil and filters	items 1438 to 1499 items 1877 to 1885
Electric system	items 1438 to 1499
Transmission	items 1438 to 1499
Suspension	items 1549 to 1569CP
Brakes	items 1438 to 1499
Wheels	items 955 to 989A
Body work	items 1302 to 1369 items 1763 to 1767A
Other equipment	items 1878 to 3067



955

tubular spark-plug wrench
chrome-plated, hexagon end



mm -"	D mm	L mm	€	Hand	Part No.
16	21	86	14,80	3	009550016
5/8					
20,8	29	86	14,80	3	009550021
13/16					

956C

1/2" square drive spark plug sockets
chrome-plated, hexagon ends



ISO 11168

mm -"	Ø mm	L mm	€	Hand	Part No.
14	18,8	70	27,50	3	009560008
9/16					
16	21,4	70	27,50	3	009560010
5/8					
17,8	23,6	70	27,50	3	009560011
11/16					
20,8	27,0	70	28,00	3	009560012
13/16					

956E

3/8" square drive spark plug sockets
chrome-plated, hexagon ends



ISO 11168

mm -"	Ø mm	L mm	€	Hand	Part No.
14	18,8	70	30,00	3	009560018
9/16					
16	21,4	70	30,00	3	009560020
5/8					
17,8	23,6	70	30,00	3	009560021
11/16					
20,8	27,0	70	30,50	3	009560022
13/16					

956F

3/8" square drive spark plug sockets



mm -"	Ø mm	L mm	€	Hand	Part No.
14	18,8	70	34,00	1	009560114
9/16					
16	20,5	70	42,00	1	009560116
5/8					

Beta

956L

1/2" square drive spark plug sockets,
bi-hex ends, long series



mm -"	Ø mm	L mm	€	Hand	Part No.
14	20,2	250	56,00	2	009560214
9/16					
16	24,0	250	58,00	2	009560216
5/8					
17,8	24,0	250	61,00	2	009560217
11/16					
20,8	28,5	250	62,50	2	009560221
13/16					

957

T-handle spark plug wrenches
with swivelling sockets

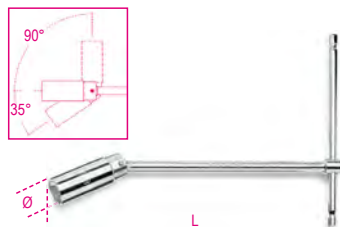

ISO 11168

mm -"	Ø mm	L mm	€	Hand	Part No.
16	21,4	275	42,50	3	009570000
5/8					
20,8	27,0	275	49,50	3	009570001
13/16					

959

T-handle spark plug wrenches
with swivelling sockets, standard series

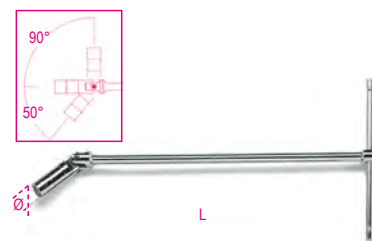

ISO 11168

mm -"	Ø mm	L mm	€	Hand	Part No.
14	18,8	483	49,00	3	009590009
9/16					
16	21,4	483	54,50	3	009590010
5/8					
20,8	27,0	527	73,00	3	009590011
13/16					

959R

rubber inset and spare spring
for items 956C - 956E - 957 - 959

Part No.	€	Hand	Part No.
959R/14 956C/14-956E/14	5,05	3	009590223
959R/16 956C/16-956E/16 957/16-959/16	5,05	3	009590224
959R/17,8 956C/17,8-956E/17,8	5,05	3	009590225
959R/20,8 956C/20,8-956E/20,8 957/20,8-959/20,8-959L	5,05	3	009590226

960

1/2" square drive socket
for Diesel engine injectors



mm	Ø mm	L mm	€	Hand	Part No.
27	36,5	77	32,00	2	009600027

960A

1/2" square drive socket
for Diesel engine injectors

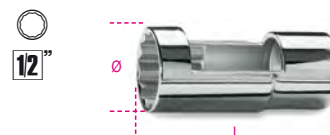

mm	Ø mm	L mm	€	Hand	Part No.
27	36,5	77	46,00	2	009600017

960BC/C5

set of 5 sockets
for injector electric connection

set contents:

- 1 open hexagon socket, 25 mm
- 1 open hexagon socket, 27 mm
- 1 open hexagon socket, 29 mm
- 1 open hexagon socket, 30 mm
- 1 bi-hex socket, 28 mm



960BC/C5 € 143,00 1 009600280

280x160x55 mm - 1,9 kg

960BC

open-end hexagon sockets
for injector electrical connections



mm	€	1	009600285
25	42,50	1	009600285
27	42,50	1	009600287
29	42,50	1	009600289
30	42,50	1	009600290

960BC/P 28

bi-hex socket
for injector electrical connections



960BC/P 28 € 42,50 1 009600288

960BT/B

sockets for injector electrical connections

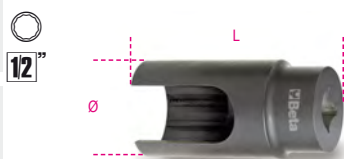

960BT/B € 112,50 1 009600128

960ER

slide hammer for injector washers

stepped drill bit



960ER L mm € 57,00 1 009600726

960F

socket for nozzle holder ring nuts



960F Ø mm € 36,50 1 009600148

960G

socket for Diesel engine injectors
of Mercedes-Benz trucks



960G Ø mm € 39,00 1 009600151

960L

socket
for nozzle holder ring nuts



960L Ø mm € 42,50 1 009600153

960M

socket
for nozzle holder ring nuts

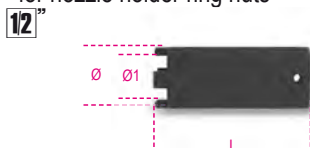

960M Ø mm € 31,00 1 009600154

960H/C4

set of sockets for nozzle holder ring nuts



960H/C4 € 111,00 1 009600152

960S

1/2" square drive socket
for Diesel engine injectors

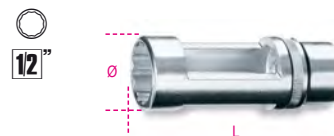

960S € 36,00 1 009600022

960SL

sockets for Lambda probes
with 1/2" female square drives



960SL85	Ø mm	€	2	009600085
○ 22xL= 85 mm	33	55,50	2	009600085
960SL110	33	63,00	2	009600110
○ 22xL= 110 mm				

960SN

Diesel engine glow plug wrenches



960SN	Ø mm	□ mm	L mm	€	2	009600834
8	12,0	1/4	60	47,50	2	009600834
9	13,3	1/4	60	47,50	2	009600835
10	14,5	3/8	70	56,50	2	009600836
11	15,8	3/8	70	56,50	2	009600837
12	17,0	3/8	70	56,50	2	009600838



960T/C11

assortment of sockets
for removing/installing

sensors

Kit contents:

- 1 double ended hexagon socket, size 1" - 11/16" for oil pressure sensors
- 1 open end hexagon socket, 29 mm, for oxygen sensors
- 1 open end bi-hex socket, 27 mm, for injectors
- 1 open end hexagon socket, 22 mm, for vacuostats
- 1 open end hexagon socket, 22 mm, 80 mm long, for oxygen sensors
- 1 open end hexagon socket, 22 mm, 90 mm long, for oxygen sensors
- 1 open end hexagon socket, 22 mm, compact, 30 mm long, for oxygen sensors
- 1 open end hexagon socket, 22 mm, compact, 50 mm long, for oxygen sensors
- 1 open end hexagon and bi-hex socket, 22 mm, compact, 34 mm long, for oxygen sensors
- 1 open end hexagon socket, 22 mm, tube-shaped
- 1 tap M18x1.5



⊕ 22 - 29 mm

960T/C11	€ 183,50	1	009600031
⊕ 330x270x25 mm			

960T/A

open end hexagon socket, 29 mm,
for oxygen sensors



⊕ mm 29	L mm 90	€ 21,50	1	009600032
---------	---------	---------	---	-----------

960T/B

open end bi-hex socket, 27 mm,
for injectors

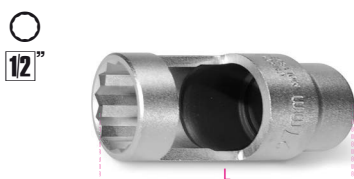

⊕ mm 27	L mm 85	€ 19,00	1	009600033
---------	---------	---------	---	-----------

960T/C

open end hexagon socket, 22 mm,
for vacuostats

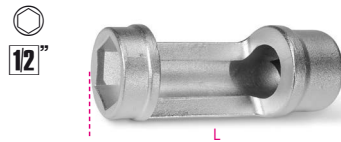

⊕ mm 22	L mm 88	€ 16,80	1	009600034
---------	---------	---------	---	-----------

960T/D

open end hexagon socket, 22 mm, 90 mm
long,
for oxygen sensors

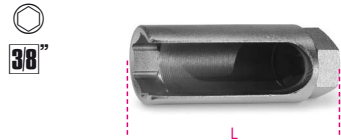

⊕ mm 22	⊕ mm 25	L mm 90	€ 15,20	1	009600035
---------	---------	---------	---------	---	-----------

960T/E

open end hexagon socket, 22 mm, 80 mm
long,
for oxygen sensors

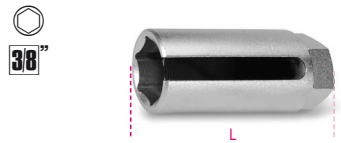

⊕ mm 22	⊕ mm 25	L mm 80	€ 13,90	1	009600036
---------	---------	---------	---------	---	-----------

960T/F

double ended hexagon socket, size 1" - 1
1/16",
for oil pressure sensors



⊕ 1 - 1 1/16	⊕ mm 28	L mm 74	€ 13,10	1	009600037
--------------	---------	---------	---------	---	-----------

960T/G

open end hexagon socket, 22 mm,
tube-shaped



⊕ mm 22	⊕ mm 25	L mm 98	€ 37,00	1	009600038
---------	---------	---------	---------	---	-----------

960T/H

open end hexagon and bi-hex socket, 22 mm,
compact, 34 mm long,
for oxygen sensors

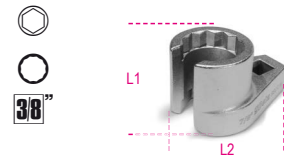

⊕ mm 22	L1 mm 34	L2 mm 55	€ 13,90	1	009600039
---------	----------	----------	---------	---	-----------

960T/I

open end socket, 22 mm, compact, 30 mm
long,
for oxygen sensors

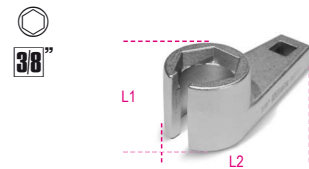

⊕ mm 22	L1 mm 30	L2 mm 81	€ 18,50	1	009600040
---------	----------	----------	---------	---	-----------

960T/L

open end socket, 22 mm, compact, 50 mm
long,
for oxygen sensors

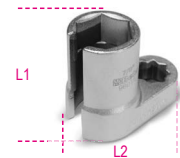

⊕ mm 22	L1 mm 50	L2 mm 58	€ 14,10	1	009600041
---------	----------	----------	---------	---	-----------

960T/M

tap M18x1.5



⊕ mm 21	L mm 50	€ 4,65	1	009600042
---------	---------	--------	---	-----------

960/22EP

double head swivel socket wrench
for Lambda probes

Double hexagon/bi-hex and 180° joint result in remarkable versatility



L	mm	mm	mm	€	1	009600052
300	22	22		50,00		

960/C6

3/8" female drive hexagon sockets
for removing/installing exhaust gas
temperature sensors

Kit contents:

- 3 short sizes, 13, 14, 17 mm
- 3 long sizes, 13, 14, 17 mm



960/C6	€ 75,50	1	009600055
--------	---------	---	-----------

170x120x50 mm

960/D

open hexagon wrenches, long series, for
removing/installing exhaust gas temperature
sensors



mm	€	1	009600073
13	11,60		
14	11,60		
17	14,00		

960YP

open offset hexagon wrenches
for removing/installing exhaust gas
temperature sensors



mm	€	1	009600063
13	12,30		
14	12,80		
17	16,90		

960AVE

device for testing common rail diesel electrical
injectors



960AVE	€ 247,50	1	009600245
--------	----------	---	-----------

430x310x50 mm - 2,0 kg

960CMB

instrument for controlling compression on
petrol engines



Bar 4÷17	€ 585,00	1	009600250
----------	----------	---	-----------

440x370x100 mm - 2,2 kg

960CMB/R2

spare cards for item 960CMB



960CMB/R2	€ 30,00	1	009600252
-----------	---------	---	-----------

960CMD

instrument for controlling compression on
Diesel engines



Bar 8÷40	€ 649,00	1	009600270
----------	----------	---	-----------

440x370x100 mm - 2,4 kg

960CMD/R1

spare cards for item 960CMD



960CMD/R1	€ 30,00	1	009600271
-----------	---------	---	-----------

960EPC

set of tools for removing glow plug electrode

M8x1 - M9x1 - M10x1 - M10x1,25



960EPC	€ 595,00	1	009600790
--------	----------	---	-----------

270x230x80 mm - 900 g

960EPC/L

set of tools for removing glow plug electrode face

M8x1 - M9x1 - M10x1 - M10x1.25



960EPC/L € 812,00 1 009600890
300x230x80 mm - 2 kg

960E-PI/P

injector washer extractor

• Male thread M10 for use with sliding hammer (Beta 1540)



960E-PI/P € 64,00 1 009600706
300x90x60 mm

960KC-M8/M9/M10

assortment of tools for removing broken or damaged glow plugs

• For spark plugs with threads M8-M9-M10



960KC-M8/9/10 € 411,00 1 009600801
380x290x50 mm - 2,3 kg

960KPC

reversible impulse extractor with adjustable torque for glow plugs

Torque can be adjusted in 4 positions: 10-20-30-40 Nm



14" CE 960KPC € 302,00 1 009600780
8-9-10-11-12 mm
420x185x60 mm - 2,8 kg

960UC

tool set for removing stuck M8-M9-M10 glow plugs with deformed tips



960UC € 471,00 1 009600900
270x230x80 mm - 2,6 kg

960P

pressure/depressure tester with accessories and adaptors



960P € 244,00 1 009600777
350x320x95 mm - 1,9 kg

960PI

assortment of reamers for cleaning injector seats

in plastic case

For removing residues from injector seats

- Flat reamer, Ø 19 - 15 mm, for universal injectors
- Flat reamer, Ø 17 - 17 mm, for Delphi/Bosch injectors (BMW/PSA/Renault/Ford)
- Flat reamer, Ø 19 - 17 mm, for Bosch injectors (Mercedes CDI)
- Angled reamer, Ø 21 - 17 mm, for Fiat/Iveco injectors.
- Handle



960PI € 113,50 1 009600215
250x130x50 mm - 600 g

960PI/C19

assortment of 19 tools for cleaning injector seats

Kit contents:

- 11 flat reamers, Ø:
14/14 mm - 15.5/15.5 mm - 15/19 mm - 17/19 mm - 17/17.5 mm - 17/19 mm - 17/19.5 mm - 17/20 mm - 18/21 mm - 19 mm - 20/21 mm
- 4 angled reamers, Ø:
15.5/15.5 mm - 17/17 mm - 17.5/20.5 mm - 17/21 mm
- Handle and cutter accessories



960PI/C19 € 284,00 1 009600217
360x230x60 mm

960PI/S

kit for cleaning injector seats

Kit contents:

- 3 steel brushes, Ø 18, 22, 25 mm, for cleaning injector seats
- 2 brushes, Ø 14 and 16 mm, for cleaning injector seat bottoms
- 6 caps for closing hole connecting with combustion chamber
- 1 brush for cleaning hole connecting with combustion chamber
- 1 flexible bit holder with handle



14" 960PI/S € 150,00 1 009600214
360x140x50 mm - 700 g

960RPI

blowing tool for injectors seat cleaning

for M8x1 - M9x1 - M10x1 - M10x1.25 glow plugs



960RPI € 181,50 1 009600940

960PMC

diesel injector test and calibrating hand pump



Bar Max. 600 € 715,00 1 009600200

960AVL

vapour extractor



Bar Max. 6 € 806,00 1 009600210

Beta

961P6

electronic videoscope with flexible probe



- Supports SD cards (8 GB)
- Supports flash memories (8 GB)
- Internal memory: 128M
- TV-OUT feature
- Supports video formats (MP4, AVI, 3GP)
- 4 LEDs
- Power supplied by USB port (built-in battery)

SPECIFICATIONS

- Sensor pixels: 640x480
- Maximum resolution: 320x240
- Probe length: 1 m
- Camera diameter: 6 mm
- Video formats: MPEG4, 3GP, AVI, ASF.
- Photo formats: JPEG
- Shooting angle: 0÷180°
- Data output: USB cable and SD card
- Power supply: 3.7V 2000 mAh battery

961P6 € 704,00 1 009610000

961P6/S

flexible probes, 6 mm



	L mm	€		
961P6/S1	1000	305,00	1	009610006
961P6/S2	2000	341,00	1	009610262
961P6/S3	3000	386,00	1	009610263

962

tyre levers



L mm	A mm	€		
300	21	22,60	5	009620003
400	25	27,00	5	009620004
500	27	35,50	3	009620005
600	27	45,50	3	009620006

962C



962C 272

962P

tyre levers with non-scratch rubber protection



L mm	A mm	€		
490	25	85,00	1	009620049

962M

tyre removal/installation tool

particularly recommended for runflat tyres and lower shoulder models

- non-scratch rim locking jaws
- tyre removal lever seat



962M € 305,00 1 009620501

963

pry bar with pointed and flat bent ends



L mm	A mm	€		
400	23	35,00	5	009630001

Beta

Quality Tools

964

pry bar with pointed and leverage ends



L mm	A mm	€	🔧	📄
400	46	31,50	5	009640001

965

pry bars with flat curved ends



L mm	A mm	L1 mm	€	🔧	📄
300	16	185	16,00	2	009650013
450	20	312	22,60	2	009650014
600	20	462	26,50	2	009650016



965/S3	€ 65,00	🔧 1	📄 009650019
--------	---------	-----	-------------

966/C3

set of 3 levers with articulated, flat, curved heads



966/C3	€ 120,00	🔧 1	📄 009660103
--------	----------	-----	-------------

L=200-250-300 mm

355x140x65 mm - 1,8 kg

720LS

impact sockets, long, slim series

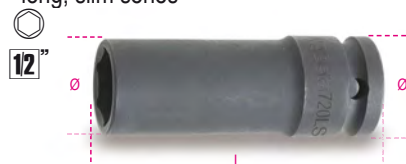

UNI/ISO 2725

🔧	Ø mm	L mm	Ø1 mm	€	🔧	📄
720LS 36	36	48,0	78	29	59,00	2 007200386

969B

hub nut locking socket

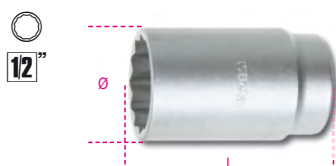

🔧	Ø mm	L mm	€	🔧	📄
24	36,0	76	20,30	1	009690124
27	36,0	76	20,80	1	009690127
30	40,0	76	21,30	1	009690130
31	42,0	76	21,90	1	009690131
32	42,5	76	23,30	1	009690132
34	45,0	76	26,00	1	009690134
35	46,0	76	26,50	1	009690135
36	49,0	76	30,50	1	009690136

969/C5

set of 5 hub nut locking sockets in plastic case



969/C5	€ 127,50	🔧 1	📄 009690201
--------	----------	-----	-------------

🔧 969B 30-32-34-35-36

970EA

impact sockets for axle nuts



🔧	mm	● mm	Ø mm	€	🔧	📄
98	98	36	122	239,50	1	009700398

970EB

impact sockets for axle nuts



🔧	mm	● mm	Ø mm	€	🔧	📄
95	95	36	126	279,00	1	009700595
110	110	36	133	276,00	1	009700410

970Q

impact sockets for rectangular nuts



L mm	□	€	🔧	📄
56	3/4"	106,50	1	009700756
60	3/4"	112,50	1	009700760

970B

socket for locking Fiat Daily hub nuts

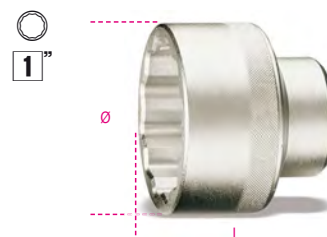

🔧	Ø mm	L mm	€	🔧	📄
65	88	75	99,50	1	009700010

970IVECO

hook socket for Iveco Daily hub nuts for versions from year 2014

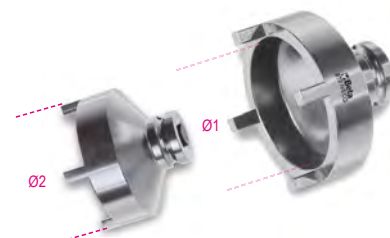

Ø1 mm	Ø2 mm	€	🔧	📄
61,5	74,8	60,00	1	009700011

970C

octagonal impact sockets for locking hub nuts



🔧	mm	□ - Ø	€	🔧	📄
80	80	41 mm	151,00	1	009700808
95	95	3/4"	214,50	1	009700815
100	100	3/4"	219,00	1	009700820
109	109	41 mm	226,00	1	009700829
115	115	3/4"	226,00	1	009700835
120	120	41 mm	228,00	1	009700840

9700T

oval impact sockets for locking trailer hub nuts

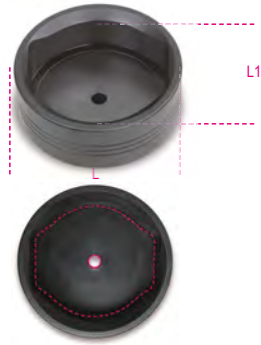

L mm	L1 mm	□ - ○ 3/4"	€	📦	🚚
65	61	3/4"	128,00	1	009700165
80	73	3/4"	146,00	1	009700180
96	90	3/4"	159,00	1	009700196
111	104	41 mm	207,50	1	009700211

971/C8

torque screwdriver with accessories for controlled tightening of tyre valves with pressure control system



971/C8	€	📦	🚚
	382,00	1	009710108

	583/6	1,2+6 Nm
	892/0	
	862TX	T10-T15-T20
	900L	11-12 mm
	986 78	

972/C4BMW

removal kit for anti-theft bolts with free rings, for BMW and Mini cars



972/C4BMW	€	📦	🚚
	218,00	1	009720004

📏 516x145x66 mm - 📦 3,8 kg

972/C10

removal kit for damaged wheel nuts

for use on anti-theft and conventional nuts



972/C10	€	📦	🚚
	275,00	1	009720010

📏 290x250x60 mm - 📦 2,4 kg

973

kit of 4 nylon wheel covers

suitable for the following rims:
14" ÷ 18" item number 009730014
19" ÷ 22" item number 009730019



- Preserves and protects wheel from scratches and dust
- During storage, it prevents early deterioration of rubber polymers in summer or winter tyres
- An icon allows wheel position (right/left front or right/left rear) identification
- Provided with handles for convenient transportation
- Fabric: nylon, washable

973 14"÷18"	€	📦	🚚
	96,00	1	009730014
973 19"÷22"	€	📦	🚚
	106,50	1	009730019

978 - 979

four-way hexagon wheel nut wrenches

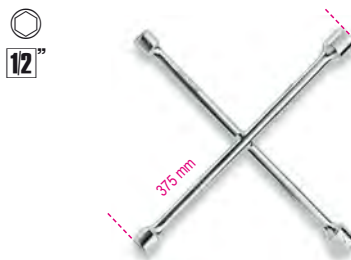

UNI/ISO 6788 DIN 3119

978	€	📦	🚚
📏 17x19x21x22 mm	61,00	2	009780001
979	€	📦	🚚
📏 17x19x22x1/2 mm	61,00	2	009790001

982

four-way hexagon wheel nut wrench

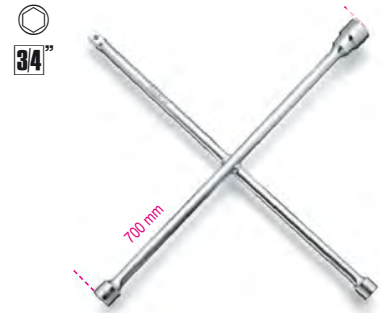

UNI/ISO 6788 DIN 3119

📏 24x27x32x3/4 mm	€	📦	🚚
	148,00	1	009820001

983PM

abrasive brush for cleaning hubs



Ø1 mm	Ø2 mm	€	📦	🚚
90	150	71,50	1	009830010

984

wheel nut plastic cap pliers



L mm	H mm	€	📦	🚚
195	4	24,20	1	009840005

985/B7

assortment of 7 guide pins for wheel installation

- Included sizes:
- M12x1.25 male
 - M12x1.25 female
 - M12x1.5 male
 - M12x1.5 female
 - M14x1.25 male
 - M14x1.5 male
 - M16x1.5 male



985/B7	€	📦	🚚
	95,00	1	009850007

985M

male guide pins for wheel installation



	L mm	€	🔧	📄
985M M12X1,25	150	12,30	1	009850101
985M M12X1,50	150	12,30	1	009850102
985M M14X1,25	150	12,80	1	009850103
985M M14X1,50	150	12,80	1	009850104
985M M16X1,50	150	14,00	1	009850105

985F

female guide pins for wheel installation



	L mm	€	🔧	📄
985F M12X1,25	150	16,50	1	009850106
985F M12X1,50	150	17,40	1	009850107

986 48

tyre valve screwdriver,
short model
automatic valve retention



L mm	L1 mm	€	🔧	📄
18	48	14,00	1	009860048

986 78

tyre valve screwdriver
automatic valve retention



L mm	L1 mm	€	🔧	📄
18	78	14,00	1	009860078

986PT

tyre valve screwdriver,
precalibrated, 0.4 Nm

automatic valve retention
slip mechanism prevents
valve core gasket
from getting damaged



L mm	L1 mm	€	🔧	📄
19	120	49,00	1	009860140

987

tyre valve lever
with rubber protection



L mm	€	🔧	📄
310	28,50	1	009870001

987AR

tyre valve lever
with non-scratch fulcrum

- rubber and nylon fulcrum for alloy and iron rims
- valve quick coupling, does not require screwing

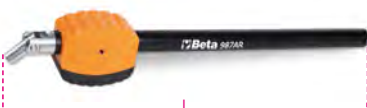

L mm	€	🔧	📄
305	95,00	1	009870021

987P

tyre valve lever
made of plastic

Handle accommodates screwdriver to work on mechanism inside valve



L mm	€	🔧	📄
335	23,90	1	009870011



988/K4

set of 4 scratchproof plastic flat chisels



988/K4 A= 19-21-25-38 mm	€	🔧	📄
	25,50	1	009880104

989

wheel balancing weight tool



L mm	€	🔧	📄
250	45,50	2	009890001

989A

pliers for removing wheel balancing adhesive weights



Nose profile specially designed to remove weights without making contact with rim

989A L mm	€	🔧	📄
220	31,00	1	009890011

989B

combination pliers for wheel balancing weights

functions:

- removing adhesive weights for alloy rims
- removing weights for iron rims
- hammer with removable PE-HD covering for adhesive weights and iron rims
- weight jaws for iron rims



L mm	€	🔧	📄
230	59,00	1	009890015

990

straight thin knurled point spring tweezers made from stainless steel bright finish



L mm 130 € 11,20 5 009900001

991

bent thin knurled point spring tweezers made from stainless steel, bright finish



L mm 130 € 13,60 5 009910001

992

straight thin knurled point pin spring tweezers made from stainless steel bright finish



L mm 150 € 14,30 5 009920001

993

bent thin knurled point pin spring tweezers made from stainless steel bright finish



L mm 145 € 15,30 5 009930001

993PL

bent thin knurled point pin spring tweezers made from stainless steel PVC-coated



L mm 150 € 15,30 3 009930010



993G

pin spring tweezers, curved round ends, knurled made from stainless steel bright finish



L mm 160 € 14,00 3 009930030

994

straight large knurled point spring tweezers made from stainless steel bright finish



L mm 150 € 11,70 5 009940001

994PL

straight large knurled point spring tweezers made from stainless steel PVC-coated



L mm 150 € 14,00 3 009940010

994TF

spring tweezers, acid and magnetic resistant, large round noses, strong and knurled ends made from stainless steel semi-bright finish



L mm 150 € 18,70 3 009940020

996

straight end spring tweezers with wide tips made from stainless steel bright finish



L mm 150 € 12,40 5 009960001

998

cross knurled end spring tweezers made from stainless steel bright finish



L mm 155 € 21,40 5 009980001

999

flat round end spring tweezers, acid and magnetic resistant made from stainless steel semi-bright finish



L mm 115 € 16,90 3 009990011

999A

extra slim short end spring tweezers, acid and magnetic resistant made from stainless steel semi-bright finish



L mm 120 € 14,80 3 009990015

999B

strong straight end spring tweezers, acid and magnetic resistant made from stainless steel semi-bright finish



L mm 120 € 15,00 3 009990017

999C

extra slim straight end spring tweezers, acid and magnetic resistant made from stainless steel semi-bright finish



L mm 110 € 16,50 3 009990019

999D

extra slim angled end spring tweezers, acid and magnetic resistant made from stainless steel semi-bright finish



L mm 115 € 18,20 3 009990021

999E

extra slim curved end spring tweezers, acid and magnetic resistant made from stainless steel semi-bright finish



L mm 120 € 16,50 3 009990023

999G

extra slim straight end spring tweezers, acid and magnetic resistant with stop mechanism made from stainless steel semi-bright finish



L mm 140 € 16,50 3 009990027

999/B6N

set of 6 spring tweezers, acid and magnetic resistant



999/B6N € 105,50 1 009990060
999-999A-999B
999C-999D-999E



1002

self-locking round end knurled tool made of stainless steel



L mm 160 € 26,50 2 010020001

1008

long flat knurled nose pliers, slip-proof double layer PVC coated handles



ISO 5745

L mm 160 L1 mm 51,5 € 24,40 5 010080006

1008BM

long flat knurled nose pliers bi-material handles



ISO 5745

L mm 160 L1 mm 51,5 € 29,50 3 010080036

1009

extra-long knurled nose pliers, slip-proof double layer PVC coated handles



ISO 5745

L mm 160 L1 mm 56,5 € 24,40 2 010090006

1009L/A

extra long needle knurled nose pliers, for special operations, slip-proof double layer PVC coated handles



L mm 283 L1 mm 80 € 29,50 2 010090008

1009L/B

curved extra long knurled nose pliers, 45°, for special operations, slip-proof double layer PVC coated handles



L mm 273 L1 mm 73 € 30,00 2 010090009

1009L/C

bent extra long knurled nose pliers, 90°, for special operations, slip-proof double layer PVC coated handles



L mm 253 L1 mm 45 € 31,50 2 010090010



1009L/D

extra-long, knurled double swivel nose pliers, slip-proof double layer PVC coated handles



L mm	L1 mm	€	1	010090058
342	71	35,50		

1009L/DP

curved extra-long knurled double swivel nose pliers, 45°, slip-proof double layer PVC-coated handles



L mm	L1 mm	€	1	010090059
336	66	35,50		

1009L/DP-S2

Set of 2 extra-long, knurled double swivel nose pliers



1009L/DP-S2	€	1	010090060
	71,00		

1010

long round knurled nose pliers, slip-proof double layer PVC coated handles

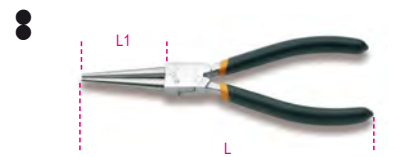

ISO 5745	L mm	L1 mm	€	2	010100006
	160	51,5	24,40		

1010BM

long round knurled nose pliers bi-material handles



ISO 5745	L mm	L1 mm	€	2	010100036
	160	51,5	29,50		

CIRCLIP PLIERS (SEEGER TYPE)

PERFECT ALIGNMENT

Tests have shown that Beta's circlip pliers provide excellent seeger (snap ring) alignment, based on the special reverse cone geometry of the tips, obtained through the company's exclusive cold-pressing technology.



REDUCED TIP BREAKAGE

Beta's pliers are fitted with built-in cold-pressed tips, which provide increased durability compared to competitors', both when used and in case of accidental drops.



1031/S4

set of 4 circlip pliers



1031/S4	€	1	010310000
1032 180	104,00		
1034 170			
1036 175			
1038 175			

1032

internal circlip pliers, straight pattern PVC-coated handles



UNI 7914 DIN 5256	L mm	Ø mm	€	5	010320013
	140x0,9	8÷12	22,90		
	140x1,3	12÷25	22,40		
	180	19÷60	24,10		
	225	40÷100	30,00		
	300	85÷200	42,50		

1033

internal circlip pliers, bent pattern, 45° PVC-coated handles



UNI 7914 DIN 5256

L mm	Ø mm	€	5	010330013
140x0,9	8÷12	26,00		
140x1,3	12÷25	25,50		
180	19÷60	26,50		
225	40÷100	33,00		

1034

internal circlip pliers, bent pattern, 90° PVC-coated handles



UNI 7914 DIN 5256

L mm	Ø mm	€	5	010340013
130x0,9	8÷12	26,00		
130x1,3	12÷25	25,50		
170	19÷60	26,50		
210	40÷100	33,00		
290	85÷200	46,00		

1034L

90° curved long nose pliers for elastic safety rings for holes, PVC-coated handles



L mm	∅ mm	€	🔧	📄
190	40÷100	67,00	2	010340320

1036

external circlip pliers, straight pattern PVC-coated handles



UNI 7915 DIN 5254

L mm	∅ mm	€	🔧	📄
140x0,9	3÷10	25,00	5	010360013
140x1,3	10÷25	24,10	5	010360014
175	19÷60	25,50	5	010360017
225	40÷100	32,00	3	010360021
300	85÷200	50,00	2	010360028

1037

external circlip pliers, bent pattern, 45° PVC-coated handles



UNI 7915 DIN 5254

L mm	∅ mm	€	🔧	📄
140x0,9	3÷10	28,00	5	010370013
140x1,3	10÷25	26,50	5	010370014
175	19÷60	28,00	5	010370017
225	40÷100	34,50	3	010370021

1038

external circlip pliers, bent pattern, 90° PVC-coated handles



UNI 7915 DIN 5254

L mm	∅ mm	€	🔧	📄
135x0,9	3÷10	28,00	5	010380013
135x1,3	10÷25	26,50	5	010380014
175	19÷60	28,00	5	010380017
220	40÷100	34,50	3	010380021
300	85÷200	54,00	2	010380028

1039

straight point pliers for internal and external circlips PVC-coated handles



L mm	∅ mm	∅ mm	€	🔧	📄
150	10÷15	6÷25	58,50	2	010390015

1558/C4

internal and external snap ring tool, screw-operated

square drive allows a high force to be applied in both operating conditions

Supplied tips: ∅ 2.5-3-3.5 mm



L mm	∅ mm	∅ mm	€	🔧	📄
1558/C4	5,5 ÷ 77	5,5 ÷ 77	156,00	1	015580100

330x220x50 mm - 900 g

1044

slip joint pliers overlapping joint PVC-coated handles

· 9-position model



ISO 8976

L mm	A max mm	L1 mm	€	🔧	📄
250	48	39	32,00	5	010440250

1044F

slip joint pliers overlapping joint PVC-coated handles

· 9-position model



ISO 8976

L mm	A max mm	L1 mm	€	🔧	📄
250	48	39	25,00	5	010440015

1046

slip joint pliers overlapping rack-type joint PVC-coated handles

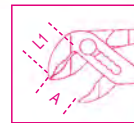

ISO 8976

L mm	A max mm	L1 mm	€	🔧	📄
240	28	33	35,50	5	010460240
400	107	55	62,50	1	010460400

1047

slip joint pliers, push button adjustment

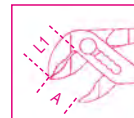

L mm	A max mm	L1 mm	€	🔧	📄
180	30	29	42,00	2	010470180
240	36	35	45,00	2	010470240
300	50	48	64,50	1	010470300

1047BM

slip joint pliers, push button adjustment, bimaterial handles

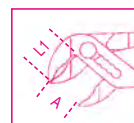

L mm	A max mm	L1 mm	€	🔧	📄
240	36	35	51,00	2	010470340



1048

Slip joint pliers, boxed joints,
slip-proof double layer PVC coated handles

· 9-position model

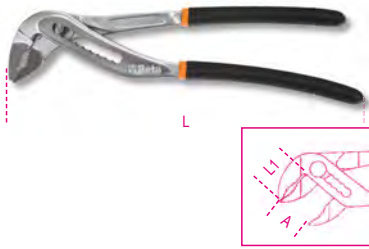

ISO 8976

L mm	A max mm	L1 mm	€	🔧	📦
175	30	29	31,00	3	010480010
250	48	39	33,50	5	010480015
300	56	47	49,50	2	010480020

1048BM

slip joint pliers, boxed joint, bimaterial handles

· new 9-position model



ISO 8976

L mm	A max mm	L1 mm	€	🔧	📦
250	48	39	44,50	3	010480215

1048V

slip joint pliers boxed joints, orange lacquered

· new 9-position model



ISO 8976

L mm	A max mm	L1 mm	€	🔧	📦
175	30	29	26,00	3	010480110
250	48	39	30,00	5	010480115
300	56	47	44,00	2	010480120

1050

double adjustment self-locking pliers



L mm	€	🔧	📦
220	74,50	2	010500022

1051

double adjustment self-locking pliers long jaws



L mm	€	🔧	📦
255	80,50	2	010510025

1051GM

double adjustment self-locking pliers,
floating jaw



L mm	€	🔧	📦
255	86,00	2	010510250

1051L

large-capacity double adjustment
self-locking pliers



L mm	€	🔧	📦
270	92,50	2	010510100

1051XL

large-capacity double adjustment
self-locking pliers, extra-long jaws



L mm	€	🔧	📦
270	110,50	2	010510140

1052

adjustable self-locking pliers,
concave jaws



L mm	A1 max mm	€	🔧	📦
140	22	24,80	3	010520014
190	36	28,00	3	010520019
240	42	30,00	3	010520024
300	55	50,00	2	010520030

1053

adjustable self-locking pliers,
floating jaw

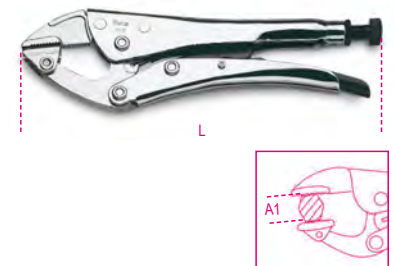

L mm	A1 max mm	€	🔧	📦
240	35	42,50	2	010530024



1054

adjustable self-locking pliers,
straight jaws

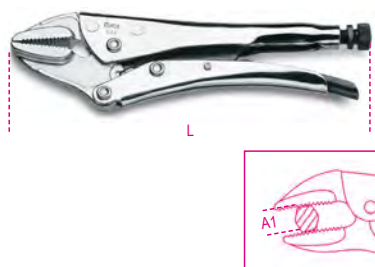

L mm	A1 max mm	€	🔧	📄
235	40	36,50	2	010540022

1055

adjustable self-locking pliers,
curved jaws

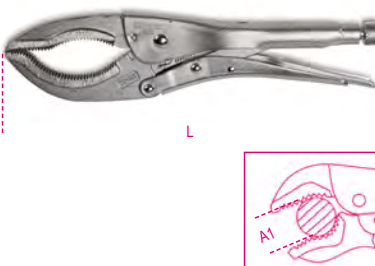

L mm	A1 max mm	€	🔧	📄
270	75	33,00	2	010550027

1056

adjustable self-locking pliers
for refrigeration technicians

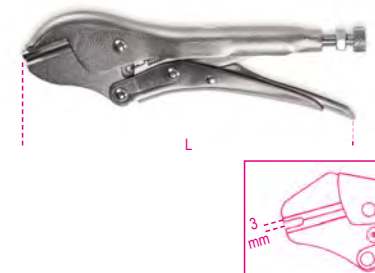

L mm	€	🔧	📄
195	25,50	2	010560017

1057A

automatic self-locking pliers with adjustable
force

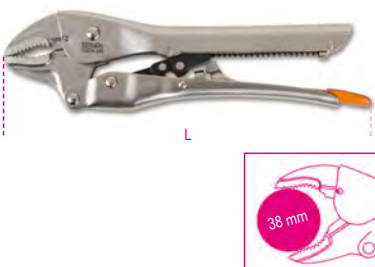

L mm	€	🔧	📄
240	52,00	2	010570124

1058

adjustable self-locking pliers,
long jaws

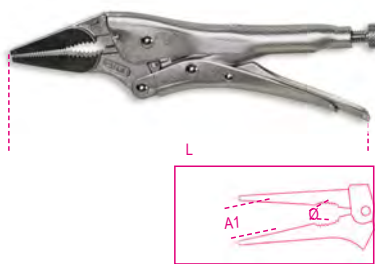

L mm	A1 max mm	Ø max mm	€	🔧	📄
175	34	26	31,50	2	010580017
225	46	31	37,50	2	010580025

1059

adjustable self-locking pliers
with one sliding jaw

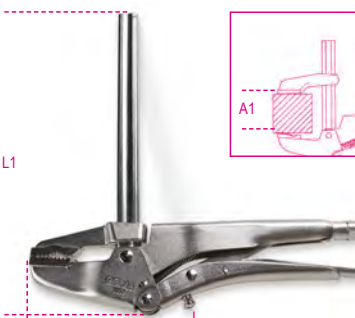

L1 mm	L mm	A1 mm	€	🔧	📄
160	255	120	56,00	1	010590016
270	255	220	59,00	1	010590027

1060

adjustable self-locking pliers,
fork-type jaws

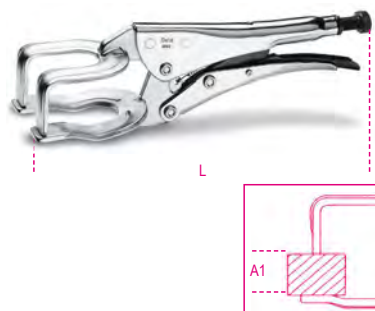

L mm	A1 max mm	€	🔧	📄
200	50	40,00	2	010600020
280	80	50,50	2	010600028

1061

adjustable self-locking pliers,
fork-type jaws

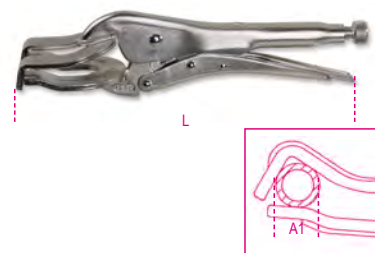

L mm	A1 max mm	€	🔧	📄
275	80	44,00	2	010610027

1062

adjustable self-locking pliers
with C-shaped jaws

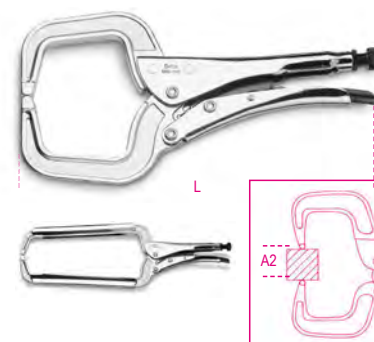

L mm	A2 max mm	€	🔧	📄
170	50	31,00	2	010620017
290	120	41,50	2	010620029
460	255	58,50	1	010620045

1062AL

adjustable self-locking pliers,
aluminium C-shaped jaws

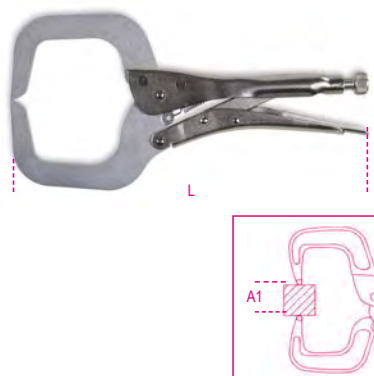

L mm	A1 max mm	€	🔧	📄
275	88	54,50	2	010620327

1062GM

adjustable self-locking pliers
with floating C-shaped jaws

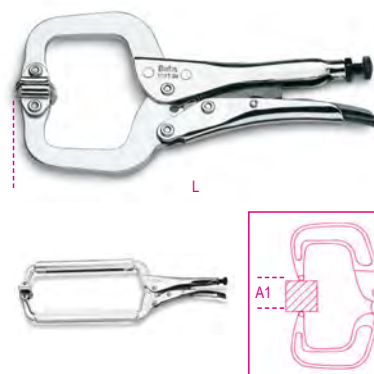

L mm	A1 max mm	€	🔧	📄
170	45	34,00	2	010620217
290	88	47,50	2	010620229
460	255	67,50	1	010620245

1063

adjustable self-locking pliers
for tinsmiths

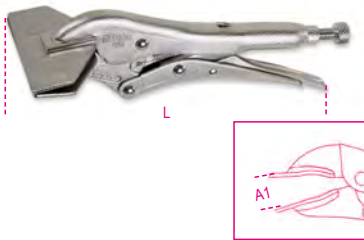

L mm	A1 max mm	€	Weight	Code
200	31	40,50	2	010630021

1064

adjustable self-locking pliers with chain



L mm	Ø mm	€	Weight	Code
230	150	57,50	2	010640023

1065F

hand punch steel punch and matrix



Ø mm	L mm	€	Weight	Code
5	228	110,00	1	010650010
6	228	111,00	1	010650015

1065P

hand crimper steel matrix



L mm	€	Weight	Code
228	113,50	1	010650020

1067

adjustable self-locking pliers for pipes,
articulated pipe clamping jaws

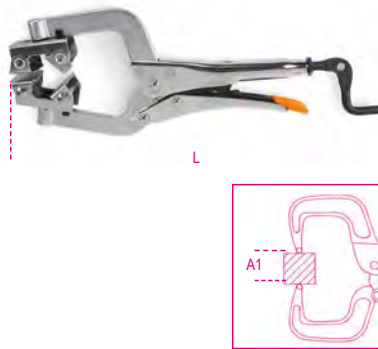

L mm	A1 max mm	€	Weight	Code
285	76	48,00	1	010670285
380	89	49,50	1	010670380

1077

straight wide blade tinsmith's pliers,
PVC-coated handles



L mm	A mm	L1 mm	€	Weight	Code
280	60	53	49,50	1	010770026

1078

curved wide blade tinsmith's pliers,
45° PVC-coated handles



L mm	A mm	L1 mm	€	Weight	Code
280	60	77	50,50	1	010780026

1080D

diagonal flush cutting nippers,
slip-proof double layer PVC coated handles

For cutting plastic

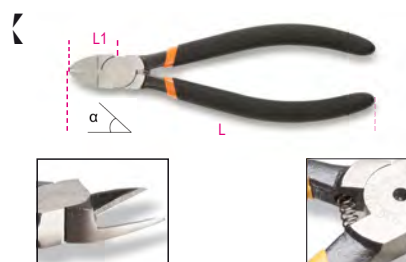

α	L mm	L1 mm	€	Weight	Code
15°	160	22	26,50	3	010800015
45°	160	22	32,00	3	010800045

1081

semi-flush cutting nippers,
slip-proof double layer PVC
coated handles

• For micro-mechanics and heavy-duty electronics

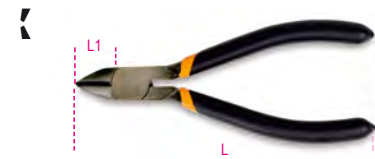

L mm	L1 mm	€	Weight	Code
125	16	27,50	3	010810130

1082

diagonal cutting nippers,
chrome-plated,
slip-proof double layer PVC coated handles



UNI/ISO 5749

L mm	L1 mm	mm	€	Weight	Code
140	20	1,6	23,70	5	010820004
160	22	1,6	25,00	5	010820006

1082G

diagonal cutting nippers,
slip-proof double layer PVC coated handles,
industrial finish



UNI/ISO 5749

L mm	L1 mm	mm	€	Weight	Code
140	20	1,6	20,50	5	010820064
160	22	1,6	21,50	5	010820066

1082BM

diagonal cutting nippers,
bi-material handles



UNI/ISO 5749

L mm	L1 mm	mm	€	Weight	Code
140	20	1,6	29,50	3	010820034
160	22	1,6	32,50	3	010820036

1082GBM

diagonal cutting nippers,
bi-material handles,
industrial finish



INDUSTRIAL
FINISHING



UNI/ISO 5749

L	L1	mm	€		
mm	mm	mm			
140	20	1,6	26,00	3	010820264
160	22	1,6	29,00	3	010820266

1084

heavy duty diagonal cutting nippers,
chrome-plated,
slip-proof double layer PVC coated handles



UNI/ISO 5749

L	L1	mm	€		
mm	mm	mm			
160	22	1,6	28,00	5	010840006
200	28	2,0	35,00	3	010840010

1084G

heavy duty diagonal cutting nippers,
slip-proof double layer PVC coated handles,
industrial finish



INDUSTRIAL
FINISHING



UNI/ISO 5749

L	L1	mm	€		
mm	mm	mm			
160	22	1,6	24,10	5	010840066
200	28	2,0	30,00	3	010840070

1084BM

heavy duty diagonal cutting nippers,
chrome-plated,
bi-material handles



UNI/ISO 5749

L	L1	mm	€		
mm	mm	mm			
160	22	1,6	34,00	3	010840036
200	28	2,0	44,00	3	010840040

1084GBM

heavy duty diagonal cutting nippers,
bi-material handles,
industrial finish



INDUSTRIAL
FINISHING



UNI/ISO 5749

L	L1	mm	€		
mm	mm	mm			
160	22	1,6	37,00	3	010840266
200	28	2,0	47,50	3	010840270

1088

heavy duty end cutting nippers,
slip-proof double layer PVC coated handles

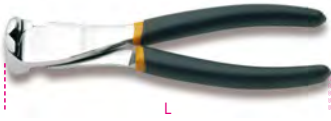

UNI/ISO 5748

L	L1	mm	€		
mm	mm	mm			
160	9	1,6	34,50	2	010880006
200	11	2,0	45,00	2	010880010

1088BM

heavy duty end cutting nippers,
bi-material handles



UNI/ISO 5748

L	L1	mm	€		
mm	mm	mm			
160	9	1,6	42,00	2	010880036
200	11	2,0	57,00	2	010880040

1092V

toggle lever assisted end cutting nippers



UNI/ISO 5748

L	L1	mm	€		
mm	mm	mm			
180	8	2,0	136,00	2	010920280
200	9	2,5	144,00	2	010920310

1094V

toggle lever assisted
diagonal cutting nippers



UNI/ISO 5749

L	L1	mm	€		
mm	mm	mm			
200	23	2,5	136,00	2	010940200

1095N

toggle lever assisted
diagonal cutting nippers



L	L1	mm	€		
mm	mm	mm			
195	26	1,6	48,00	2	010950010

1096

carpenter's pincers



ISO 9243

L	L1	mm	€		
mm	mm	mm			
160	21		18,40	5	010960016
200	23		21,30	5	010960020
250	30		28,50	5	010960025



1098

construction worker's pincers



ISO 9242 DIN 5242

L	L1	€	🔧	📦
~	mm			
190	12	18,40	5	010980190
220	13	20,80	5	010980220
250	15	24,80	5	010980250
280	18	27,50	5	010980280

1098PL

construction worker's pincers,
PVC coated handles



ISO 9242 DIN 5242

L	L1	€	🔧	📦
~	mm			
220	13	23,10	5	010980320
250	15	26,50	5	010980350
280	18	29,00	5	010980380

1101

bolt cutter phosphatized blades
and rubber grip handles



L	L	€	🔧	📦
mm	mm			
300	12	54,50	2	011010030
350	14	66,50	2	011010035
450	18	81,50	1	011010045
600	24	111,50	1	011010060
750	30	144,00	1	011010075
900	36	193,00	1	011010090

L	R = 80	R = 140	g	🔧
mm	Kgf/mm ²	Kgf/mm ²	Ø mm	
300	5	4	745	🔧
350	6	5	1043	🔧
450	7	6	1537	🔧
600	9	7	2540	🔧
750	11	8	3870	🔧
900	12	9	6170	🔧

Beta

1101R

spare blades for item 1101



mm	1101	€	🔧	📦
300	300	32,50	1	011010130
350	350	37,50	1	011010135
450	450	48,00	1	011010145
600	600	65,50	1	011010160
750	750	80,50	1	011010175
900	900	106,50	1	011010190

1102

bolt cutters, small series

Cutting capacity
R= 80 Kgf/mm²



L	mm	€	🔧	📦
230	4	40,50	3	011020020

1104

heavy-duty cutters for flexible steel cables,
handles with thermoplastic grips



L	mm	€	🔧	📦
420	12	140,00	1	011040004
600	16	204,50	1	011040006

1104R

spare blades for item 1104



mm	€	🔧	📦
420	86,50	1	011040014
600	121,00	1	011040016

Beta

Quality Tools

1105

punches made from burnished steel



D	L	€	🔧	📦
mm	mm			
2	27	13,90	1	011050002
3	27	13,90	1	011050003
4	27	13,90	1	011050004
5	27	13,90	1	011050005
6	27	13,90	1	011050006
7	27	13,90	1	011050007
8	27	13,90	1	011050008
9	27	13,90	1	011050009
10	27	13,90	1	011050010
12	27	17,00	1	011050012
14	27	17,00	1	011050014
16	27	17,00	1	011050016
18	27	17,00	1	011050018
20	27	17,00	1	011050020
22	32	21,30	1	011050022
24	32	21,30	1	011050024
26	32	21,30	1	011050026
28	32	21,30	1	011050028
30	32	21,30	1	011050030
32	37	28,00	1	011050032
34	37	28,00	1	011050034
36	37	28,00	1	011050036
38	37	28,00	1	011050038
40	37	28,00	1	011050040
42	42	33,00	1	011050042
44	42	33,00	1	011050044
46	42	33,00	1	011050046
48	42	33,00	1	011050048
50	42	33,00	1	011050050

1105T20

shank for punches 1105,
2 to 20 mm



L	mm	€	🔧	📦
110		69,00	1	011050200

1105T30

shank for punches 1105,
3 to 30 mm



L	mm	€	🔧	📦
175		149,00	1	011050205

Beta

1105T50

shank for punches 1105
2 to 50 mm



L mm	€		
175	147,00	1	011050207

1105AD-50

shank adaptor for item 1105T50



∅ mm	€		
57	93,00	1	011050210

1105/C10T

assortment of 10 punches,
3 to 20 mm, and 1 accessory



1105/C10T	€		
	155,00	1	011050250

1105	3 - 4 - 6 - 8 - 10 - 12 - 14 - 16 - 18 - 20 mm
1105T20	

≡ 135x92x32 mm

1105/C16T

assortment of 15 punches,
3 to 30 mm, and 1 accessory



1105C/16T	€		
	280,00	1	011050255

1105	3 - 4 - 6 - 8 - 10 - 12 - 14 - 16 - 18 - 20 - 22 - 24 - 26 - 28 - 30 mm
1105T30	

≡ 240x210x60 mm

1105/C32T

assortment of 29 punches,
2 to 50 mm, and 3 accessories



1105/C32T	€		
	546,00	1	011050257

1105	2 - 3 - 4 - 5 - 6 - 7 - 8 - 9 - 10 - 12 - 14 - 16 - 18 - 20 - 22 - 24 - 26 - 28 - 30 - 32 - 34 - 36 - 38 - 40 - 42 - 44 - 46 - 48 - 50 mm
1105T50	
1105AD-50	

≡ 455x380x115 mm

1112

tin snips straight wide blades

Cutting capacity
R = 60 Kgf/mm²



L	L1	S	A	€		
200	50	0,5	26	24,20	2	011120020
250	62	0,8	33	29,00	2	011120025
300	76	1,0	37	37,50	2	011120030
375	76	1,2	44	55,50	1	011120037

1114

tin snips straight narrow blades

R = 60 Kgf/mm²

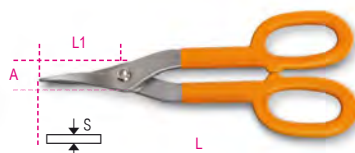

L	L1	S	A	€		
250	58	0,5	15	26,00	1	011140265
350	76	1	22	34,50	1	011140340

1118

safety strap cutting shears

Fe = normal steel
Inox = stainless steel



L	L1	Fe	Inox	€		
310	42	S mm	S mm	43,00	2	011180001

1120A

hand nibbler

Fe = normal steel



L	Fe	€		
280	S mm	68,50	1	011200101

1120ARL - ARG

spare parts for item 1120A



1120ARL	€		
	16,90	1	011200110
1120ARG	€		
	21,30	1	011200120

1122

compound leverage shears,
straight blades

Inox = stainless steel



L	L1	Inox	A	€		
250	40	S mm	mm	33,00	2	011220020

1123

right cut compound leverage shears,
curved blades

Inox = stainless steel



L	L1	Inox	A	€		
250	40	S mm	mm	33,00	2	011230020

1124

left cut compound leverage shears,
curved blades

Inox = stainless steel



L	L1	Inox	A	€		
~	mm	S mm	mm			
250	40	1	24	33,00	2	011240020

1125

compound leverage shears
for straight and right cuts

Inox = stainless steel



L	L1	Inox	A	€		
~	mm	S mm	mm			
250	35	1	46	51,50	2	011250020

1126

compound leverage shears
for straight and left cuts

Inox = stainless steel



L	L1	Inox	A	€		
~	mm	S mm	mm			
250	35	1	46	51,50	2	011260020

1122 - 1125MOL



1122 MOL	1122 - 1124	1,48	1	011220010
1123 MOL	1123	1,25	1	011230010
1125 MOL	1125 - 1126	1,25	1	011250040

1127

telephone engineer's scissors,
straight blades



L	L1	€		
mm	mm			
150	35	14,50	5	011270001

Beta

Quality Tools

1128BAX

Double-acting electricians' scissors,
with milling profiles in DLC-coated stainless
steel

Double-acting cutting: a special cam on the fulcrum allows the blades to run lengthwise, which results in increased cutting power while closing the blades.

Profile and mill: designed to enlarge holes on plastic, from 13 mm to 25 mm.

DLC coating: DLC (diamond-like carbon) is an innovative carbon-based coating: the high hardness and low coefficient of friction arise from the simultaneous presence of carbon on the surface in the form of graphite, and diamond.

- High blade surface hardness (resistance to abrasion and wear)
- Low coefficient of friction (smoothness and anti-adherence)
- Anti-loose eccentric pin
- Large handles with pipe throttling grooves
- With articulated plastic case



L	L1	mm ²	€		
mm	mm				
150	50	50	32,00	5	011280088

1128BMX

electrician's scissors,
straight stainless steel blades,
with microteeth



L	L1	€		
mm	mm			
147	58,2	16,90	5	011280051

1128BMX/F

articulated plastic case
for item 1128BMX



1128BMX/F	1,71	1	011280059
-----------	------	---	-----------

1128BSX

electrician's scissors
with graduated milling profiles with case



L	L1	€		
mm	mm			
148	58,2	29,00	5	011280061

1128FX

electrician's scissors,
straight stainless steel blades,
with microteeth, cable cutting groove and
crimping pliers for tube terminals

- Articulated belt hook case
- Bimaterial handles
- Anti-loose pin



L	L1	mm ²	€		
mm	mm				
145	52	50	31,00	5	011280090



Beta

1128FXS ELECTRICIAN'S SCISSORS WITH GRADUATED MILLING PROFILES

To redesign our electrician's scissors, we observed users' daily work. We have made it into a universal tool, incorporating the 4 main features into one object.

CUTTING Quick and sharp, for cables up to 50 mm², with a cable cutting groove and a microtoothed blade, for improved hold.

STRIPPING The sensitive anti-loosening pin allows even the thinnest cables to be accurately stripped.

CRIMPING Safe and durable, for tube terminals.

COUNTERSINKING The milling profile allows the holes in pull boxes to be countersunk accurately and neatly.



1128BAX DOUBLE-ACTING ELECTRICIANS' SCISSORS WITH MILLING PROFILES IN DLC-COATED STAINLESS STEEL

Scissors 1128BAX stand out for their DLC-finished blades. DLC (diamond-like carbon) is an innovative carbon-based coating: the high hardness and low coefficient of friction arise from the simultaneous presence of carbon on the surface in the form of graphite, and diamond.

- High blade surface hardness - resistance to abrasion and wear
- Low coefficient of friction - smoothness and anti-adherence

Milling profile: designed to enlarge holes on plastic, from 13 mm to 25 mm.



+HARDNESS
-COEFFICIENT OF FRICTION



1128FXS

electrician's scissors with graduated milling profiles, straight stainless steel blades, with microteeth, cable cutting groove and crimping pliers for tube terminals

- Articulated belt hook case
- Bimaterial handles
- Anti-loose pin

• Profile and mill: designed to enlarge holes on plastic, from 13 to 21 mm.



L	L1	mm ²	€	5	011280095
145	52	50	36,50	5	011280095

1128BM

electrician's scissors, straight blades



L	L1	€	5	011280000
145	50	14,80	5	011280000

1129BM

electrician's scissors, curved blades



L	L1	€	5	011290000
145	44	15,70	5	011290000

1130BMX

Multiuse scissors, straight stainless steel blades, with microteeth



L	L1	€	1	011300002
185	60	19,00	1	011300002

1131CK

Kevlar® and fibre optics scissors



L	L1	€	1	011310001
203	75	76,50	1	011310001

1132

cable cutters for insulated copper and aluminium cables, slip-proof double layer PVC coated handles



L	mm	mm ²	€	2	011320107
170	14	50	46,00	2	011320107
230	18	95	57,00	2	011320113

1132BM

cable cutters for insulated copper and aluminium cables, bi-material handles



L	mm	mm ²	€	2	011320137
170	14	50	57,00	2	011320137
230	18	95	70,00	2	011320143

1133

cable cutter for copper cables, flexible

up to 325 mm²



L	mm	mm ²	€	1	011330001
600	32	300	159,00	1	011330001

1133RL

spare blades for item 1133



1133RL	€ 119,50	1	011330011
--------	----------	---	-----------

1134

ratchet cable cutters burnished finish, plastic handles



L mm	mm	mm ²	€		
260	35	400	463,00	1	011340032

1134RL

spare blade for item 1134



1134RL	€ 210,00	1	011340132
--------	----------	---	-----------

1134A

ratchet cable cutters burnished finish, plastic handles



L mm	mm	mm ²	€		
240	45	500	704,00	1	011340045

1134A/RL

spare blade for item 1134A



1134A/RL	€ 324,00	1	011340145
----------	----------	---	-----------

1142BM

wire stripping pliers, bi-material handles



UNI 7923

L mm	mm ²	mm	€		
160	0,5÷6	0-2,8	37,50	3	011420036

1143

wire stripping pliers



L mm	mm ²	mm	€		
165	0,5÷6	1-3,2	74,50	1	011430001

1143R

spare blades for item 1143

1143R	€ 18,70	1	011430011
-------	---------	---	-----------

1144D

cable stripping tool



L mm	mm ²	mm	€		
170	4,5÷240	2,5-18	89,00	1	011440010

1144D/RG

spare hook for item 1144D



1144D/RG	€ 29,50	1	011440012
----------	---------	---	-----------

1144D/RL

spare blades for item 1144D

1144D/RL	€ 45,50	1	011440011
----------	---------	---	-----------

1144G

cable stripping tool

with adjustable blade for transverse and longitudinal cuts



L mm	mm ²	mm	€		
140	6÷75	2,8-12	49,50	1	011440004

1144G/RL

spare blade for item 1144G



1144G/RL	€ 10,90	1	011440005
----------	---------	---	-----------

1144L

cable stripping tool with adjustable blade depth, for transverse and longitudinal stripping

with smooth and hook-shaped retractable blade



L mm	mm ²	mm	€		
145	6-150	4-28	28,50	1	011440050

1148A

wire stripping pliers, self-adjusting, with cutting device

cutting capacity
≠10 mm² (8 AWG) flexible wires
≠1,5 mm² (16 AWG) sturdy wires



L mm	mm ²	mm	€		
190	0,02÷10	0-4	152,00	1	011480100

1148A/R

spare blades for item 1148A



1148A/R	€ 65,50	1	011480102
---------	---------	---	-----------

1148B

wire stripping pliers, self-adjusting, with cutting device



L mm	mm ²	mm	€		
190	4÷16	2-5	178,50	1	011480200

1148B/R

spare blades for item 1148B



1148B/R	€ 81,50	1	011480202
---------	---------	---	-----------

1148P

wire stripping pliers, self-adjusting, with cutting device



L mm	mm ²	mm	€	Hand	Code
165	0.2-6	0-3.5	43,00	1	011480300

1149F

front wire stripping pliers with cutting blade, self-adjusting



L mm	mm ²	€	Hand	Code
175	0,2 ÷ 6	16,50	1	011490010

1150

combination pliers
bright chrome-plated,
slip-proof double layer PVC coated handles

- The decentralized pin increases the lever effect, thereby reducing effort, for powerful cutting capacity.



ISO 5746					
L mm	L1 mm	mm	€	Hand	Code
160	42	1,6	21,00	5	011500046
180	46	1,8	23,00	5	011500048
200	50	2,0	25,00	5	011500050
220	50	2,0	27,50	2	011500052

1150G

heavy duty combination pliers,
slip-proof double layer PVC coated handles,
industrial finish

- The decentralized pin increases the lever effect, thereby reducing effort, for powerful cutting capacity.



ISO 5746					
L mm	L1 mm	mm	€	Hand	Code
160	42	1,6	19,70	5	011500066
180	46	1,8	21,40	5	011500068
200	50	2,0	23,70	5	011500070
220	50	2,0	25,00	2	011500072

1150HPC HEAVY DUTY UNIVERSAL PLIERS WITH CUTTING EDGES MADE OF M2 SINTERED STEEL

- The decentralized pin allows the fulcrum to be closer to the cutting point, thereby resulting in an improved lever effect.
- Perfect alignment of the nose and the thin profile allow the pliers to be used in very small areas.
- The body of the pliers is made of a reliable molybdenum steel which has been heat treated in order to be flexible and resistant so as to guarantee a safe grip in any moment.

Shearing stress - static test = **-73%**

Average life of cutting edges = **+127%**
(test ISO 5744)

Hardness of M2 steel cutting edges = **65HRC**

**ABSOLUTELY
GROUNDBREAKING**

**PEARL CHROME-PLATED
FINISH**

**REMARKABLE CUTTING
CAPACITY**



1150HPC

heavy duty combination pliers with integrated cutting edges and decentralized pin
matt chrome plated finish
bi-material handles

open joint
integrated cutting edge
steel: M2
thickness: 0.20 mm
angle: 62°
hardness: 63+65 HRC



ISO 5746

L mm	L1 mm	mm	€	Hand	Code
180	42	1,8	56,50	2	011500618

1150BM

combination pliers bright chrome-plated,
bi-material handles

- The decentralized pin increases the lever effect, thereby reducing effort, for powerful cutting capacity.



ISO 5746

L mm	L1 mm	mm	€	Hand	Code
160	42	1,6	26,00	3	011500146
180	46	1,8	28,50	3	011500148
200	50	2,0	31,50	3	011500150
220	50	2,0	34,00	2	011500152

1150GBM

heavy duty combination pliers,
bi-material handles,
industrial finish

- The decentralized pin increases the lever effect, thereby reducing effort, for powerful cutting capacity.



INDUSTRIAL FINISHING

ISO 5746

L mm	L1 mm	mm	€	🔧	📦
160	42	1,6	24,40	3	011500266
180	39	1,8	26,00	3	011500268
200	50	2,0	29,50	3	011500270
220	50	2,0	31,50	2	011500272

1153

adjustable pliers,
two positions, PVC-coated handles



UNI ISO 9343

L mm	L1 mm	€	🔧	📦
200	34	23,90	2	011530120

1162

extra-long flat knurled nose pliers,
chrome-plated,
slip-proof double layer PVC coated handles



ISO 5745

L mm	L1 mm	mm	€	🔧	📦
160	58	1,6	24,70	5	011620006
200	86	1,6	28,50	5	011620010

1162G

extra-long flat knurled nose pliers,
slip-proof double layer PVC coated handles,
industrial finish



INDUSTRIAL FINISHING

ISO 5745

L mm	L1 mm	mm	€	🔧	📦
160	58	1,6	21,00	5	011620066
200	86	1,6	24,40	5	011620070

1162BM

extra-long flat knurled nose pliers,
chrome-plated,
bi-material handles



ISO 5745

L mm	L1 mm	mm	€	🔧	📦
160	58	1,6	30,00	3	011620036
200	86	1,6	34,00	3	011620040

1162GBM

extra-long flat knurled nose pliers,
bi-material handles,
industrial finish



INDUSTRIAL FINISHING

ISO 5745

L mm	L1 mm	mm	€	🔧	📦
160	58	1,6	26,00	3	011620266
200	86	1,6	30,50	3	011620270

1164

extra long bent flat knurled nose pliers,
slip-proof double layer PVC coated handles



ISO 5745

L mm	L1 mm	mm	€	🔧	📦
160	54	1,6	27,00	5	011640006
200	76	1,6	30,00	5	011640010

1164BM

extra long bent flat knurled nose pliers,
bi-material handles



ISO 5745

L mm	L1 mm	mm	€	🔧	📦
160	54	1,6	33,00	3	011640036
200	76	1,6	37,00	3	011640040

1166

extra-long needle knurled nose pliers,
chrome-plated,
slip-proof double layer PVC coated handles



ISO 5745

L mm	L1 mm	mm	€	🔧	📦
160	56	1,6	24,70	5	011660006
200	76	1,6	28,50	5	011660010

1166G

extra-long needle knurled nose pliers,
slip-proof double layer PVC coated handles,
industrial finish

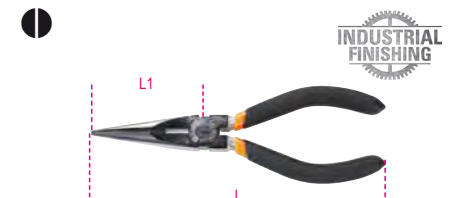

INDUSTRIAL FINISHING

ISO 5745

L mm	L1 mm	mm	€	🔧	📦
160	56	1,6	21,00	5	011660066
200	76	1,6	24,40	5	011660070

1166BM

extra-long needle knurled nose pliers,
chrome-plated,
bi-material handles



ISO 5745

L mm	L1 mm	mm	€	🔧	📦
160	56	1,6	30,00	3	011660036
200	76	1,6	34,00	3	011660040



1166GBM

extra-long needle knurled nose pliers,
bi-material handles,
industrial finish



ISO 5745

L mm	L1 mm	mm	€	Hand	Computer
160	56	1,6	26,00	3	011660266
200	76	1,6	30,50	3	011660270

1168

extra-long bent needle knurled nose pliers,
chrome-plated,
slip-proof double layer PVC coated handles



ISO 5745

L mm	L1 mm	mm	€	Hand	Computer
160	54	1,6	27,00	5	011680006
200	76	1,6	30,00	5	011680010

1168G

extra-long bent needle knurled nose pliers,
slip-proof double layer PVC coated handles,
industrial finish



ISO 5745

L mm	L1 mm	mm	€	Hand	Computer
160	54	1,6	23,00	5	011680066
200	76	1,6	26,00	5	011680070

1168BM

extra-long bent needle knurled nose pliers,
chrome-plated,
bi-material handles



ISO 5745

L mm	L1 mm	mm	€	Hand	Computer
160	54	1,6	33,00	3	011680036
200	70	1,6	37,00	3	011680040

1168GBM

extra-long bent needle knurled nose pliers,
bi-material handles,
industrial finish



ISO 5745

L mm	L1 mm	mm	€	Hand	Computer
160	54	1,6	29,00	3	011680266
200	70	1,6	33,00	3	011680270

1169/D3

set of 1 combination pliers, 1 long needle nose
pliers and 1 diagonal cutting nippers



€	Hand	Computer
72,50	1	011690053



1169G/D3

set of 1 combination pliers,
1 long needle nose pliers
and 1 diagonal cutting nippers, slip-proof
double layer PVC, industrial finish



€	Hand	Computer
64,00	1	011690073

1169BM/D3

set of 1 combination pliers, 1 long needle
nose pliers and 1 diagonal cutting nippers



€	Hand	Computer
91,00	1	011690133

1169GBM/D3

set of 1 combination pliers,
1 long needle nose pliers
and 1 diagonal cutting nippers, bi-material
handles, industrial finish



€	Hand	Computer
81,00	1	011690273

1171BM

smooth, flat short nose pliers
bi-material handles

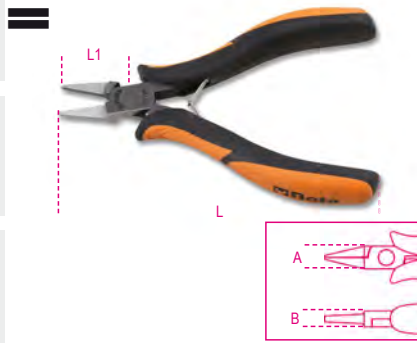

ISO 9655

L	L1	A	B	€	U	IT
130	18 mm	12 mm	8 mm	41,50	2	011710101

1173BM

round short nose pliers
bi-material handles



ISO 9655

L	L1	A	B	€	U	IT
125	22 mm	12 mm	8 mm	41,50	2	011730101

1177BM/Z

half-round long knurled nose pliers
bi-material handles

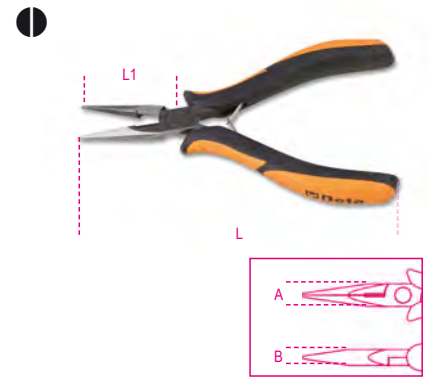

ISO 9655

L	L1	A	B	€	U	IT
140	39 mm	12 mm	8 mm	47,00	2	011770113

1172BM

smooth, flat long nose pliers
bi-material handles

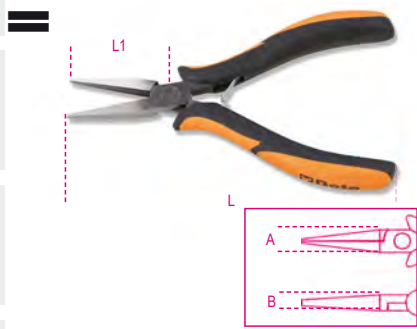

ISO 9655

L	L1	A	B	€	U	IT
140	40 mm	12 mm	8 mm	41,50	2	011720101

1175BM

smooth half-round short nose pliers
bi-material handles



ISO 9655

L	L1	A	B	€	U	IT
140	29 mm	12 mm	8 mm	41,50	2	011750101

1178BM

smooth half-round long needle nose pliers
bi-material handles

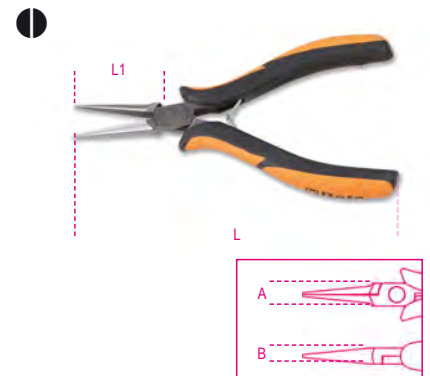

ISO 9655

L	L1	A	B	€	U	IT
140	37 mm	12 mm	8 mm	47,00	2	011780101

1172BM/P

smooth, flat bent long nose pliers
bi-material handles



L	L1	A	B	€	U	IT
140	38 mm	12 mm	13 mm	47,00	2	011720102

1177BM

smooth half-round long nose pliers
bi-material handles

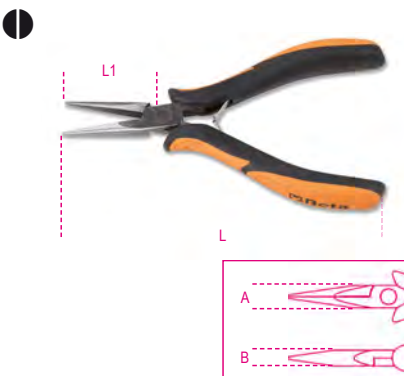

ISO 9655

L	L1	A	B	€	U	IT
140	38 mm	12 mm	8 mm	41,50	2	011770101

1178BM/P

smooth half-round long bent
needle nose pliers
bi-material handles



L	L1	A	B	€	U	IT
140	36,5 mm	12 mm	12 mm	47,00	2	011780102

Copper cutting nippers.
For heavier duty jobs see item 1081

1182BM

diagonal semi-flush cutting nippers,
slim tips
bi-material handles



ISO 9654					
L	L1	A	Cu	€	
mm	mm	mm	mm		
120	11	10	1	47,00	2 011820101
130	13	12,5	1,25	47,00	2 011840102

1183BM

diagonal semi-flush cutting nippers,
rounded tips
bi-material handles



ISO 9654					
L	L1	A	Cu	€	
mm	mm	mm	mm		
120	11	10	1	47,00	2 011830101

1184BM

diagonal flush cutting nippers,
rounded tips
bi-material handles



ISO 9654					
L	L1	A	Cu	€	
mm	mm	mm	mm		
120	11	10	1	47,00	2 011840101
130	13	12,5	1,25	47,00	2 011840102

1185BM

diagonal flush cutting nippers,
slim tips
bi-material handles



ISO 9654					
L	L1	A	Cu	€	
mm	mm	mm	mm		
120	11	10	1	47,00	2 011850101
130	13	12,5	1,25	47,00	2 011850102

1186BM

diagonal flush cutting nippers,
slim tapering tips
bi-material handles



ISO 9654					
L	L1	A	Cu	€	
mm	mm	mm	mm		
120	11	10	1	47,00	2 011860101
130	13	12,5	1,25	47,00	2 011860102

1188BM

diagonal axial cutting nippers
bi-material handles



ISO 9654					
L	L1	A	Cu	€	
mm	mm	mm	mm		
125	12	12	1,25	47,00	2 011880101
130	17	15	2	47,00	2 011880102

1190BM

end semi-flush cutting nippers
bi-material handles



ISO 9654					
L	L1	A	Cu	€	
mm	mm	mm	mm		
120	12	12	1,25	47,00	2 011900113



1191BM

end flush oblique cutting nippers
bi-material handles

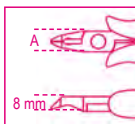

ISO 9654

L	L1	A	Cu	€	🔧	📦
mm	mm	mm	mm			
130	8	12	0,8	47,00	2	011910101

1191BM/L

end flush long oblique cutting nippers
bi-material handles

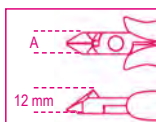

ISO 9654

L	L1	A	Cu	€	🔧	📦
mm	mm	mm	mm			
130	18	12	1	47,00	2	011910110

1191R/5-M

spare spring kit for pliers and nippers for
electronics, 5 pairs (items: 1171...1191)

1191R/5-M	€	🔧	📦
	9,30	1	011910995

1200MS

magnetizer/demagnetizer



1200MS	€	🔧	📦
	15,20	5	012000000

Beta **EVOLX**

THE EVOLUTION OF THE SCREWDRIVER!

The ergonomic design fits the palm of the hand perfectly. The large contact surface makes it possible to transmit maximum force with minimum effort.

Beta's tried-and-tested blades ensure unique elasticity, hardness and wear resistance, for top-end professional tools.

The octagonal section prevents any bothersome rolling on the worktop.

The precision area allows the screwdriver to be quickly rotated between the fingers.

The hole on the handle allows the screwdriver to hang for easy storage.

New thermoplastic rubber makes each use including heavy-duty ones even more comfortable.

The style and size of the tip is printed on the round cap for quick identification.



● Beta's tried-and-tested blades ensure unique elasticity, hardness and wear resistance, for top end professional tools.

● **The ergonomic design** fits the palm of the hand perfectly. The large contact surface makes it possible to transmit maximum force with minimum effort.

● **The octagonal section** prevents any bothersome rolling on the worktop.

● **New thermoplastic rubber** makes each use including heavy-duty ones even more comfortable.

● **The brand-new hole on the handle** allows the screwdriver to hang for easy storage.



● **The style and size of the tip** is printed on the **round cap** for quick identification.

● **The precision area** allows the screwdriver to be quickly rotated between the fingers.

1201E

screwdriver for slotted head screws



ISO 2380

SxAxL mm	L1 mm	Ø mm	€	🔧	📦
0,4x2,5x50	146	2,5	3,80	5	012011003
0,4X2,5x75	166	2,5	3,95	5	012011006
0,5x3x75	171	3,0	4,00	5	012011009
0,5x3x100	196	3,0	4,30	5	012011012
0,6x3,5X75	171	3,5	4,30	5	012011018
0,6x3,5x100	196	3,5	4,40	5	012011021
0,8x4x100	196	4,0	4,45	5	012011030
0,8x4x125	221	4,0	4,65	5	012011033
0,8x4X150	246	4,0	5,05	5	012011036
1,0x5,5x100	209	5,0	5,50	5	012011039
1,0x5,5X125	234	5,0	5,80	5	012011040
1,0x5,5x150	259	5,0	5,90	5	012011042
1,2x6,5X100	220	6,0	6,55	5	012011048
1,2x6,5x125	234	6,0	6,80	5	012011050
1,2x6,5x150	270	6,0	6,95	5	012011051
1,2x8x150	282	8,0	8,95	3	012011057
1,2x8X200	332	8,0	9,65	3	012011060
1,6x10x200	332	9,5	11,10	3	012011066



SxAxL mm	€	🔧	📦
1201E/S6 0,5x3x75-0,6x3,5x100 0,8x4x100-1,0x5,5x100 1,2x8x150-1,6x10x200 mm	38,50	1	012011206

1201EN

screwdriver for slotted head screws,
extra-short series



ISO 2380

SxAxL mm	L1 mm	Ø mm	€	🔧	📦
0,8x4x30	86,5	4	5,40	3	012011103
1,2x6,5x30	86,5	6	5,70	3	012011106

1201E/DZ

screwdriver for Dzus® head screws



L mm	L1 mm	€	🔧	📦
53	173	13,00	2	012011501

1202E

screwdriver for cross head Phillips® screws



UNI-ISO 8764

PHxDxL mm	L1 mm	€	🔧	📦
0x3x60	156	3,95	5	012021003
0x3X100	200	4,40	5	012021006
1x4,5x80	189	5,00	5	012021009
1x4,5x120	229	5,65	5	012021012
2x6x100	220	6,80	5	012021018
2x6x150	270	7,35	5	012021021
3x8x150	282	9,40	3	012021024
4x9,5x200	332	12,30	3	012021027



SxAxL mm	€	🔧	📦
1202E/S4 PH0x3x60-PH1x4,5x120 PH2x6x150-PH3x8x150 mm	26,50	1	012021204

1202EN

screwdriver for cross head Phillips®
screws, extra-short series



UNI-ISO 8764

PHxDxL mm	L1 mm	€	🔧	📦
1x4,5x30	86,5	5,40	3	012021103
2x6x30	86,5	5,70	3	012021106

1202EL

screwdriver for cross head Phillips® screws,
long series



UNI-ISO 8764-1

PHxDxL mm	L1 mm	€	🔧	📦
0x3x300	400	6,95	3	012021303
1x4,5x300	400	7,60	3	012021305
1x4,5x400	508	9,30	3	012021306
2x6x400	519	10,70	3	012021309

1203E/D

set of screwdrivers



Set	€	🔧	📦
1203E/D5	29,00	1	012031001

1201E 0,6x3,5x100-1,0x5,5x150
1,2x6,5x150 mm
1202E PH1x4,5x80-PH2x6x100 mm

Set	€	🔧	📦
1203E/D5PZ	28,00	1	012031003

1201E 0,5x3x75-0,8x4x125
1,0x5,5x150 mm
1209E/PZ PZ1x4,5x80-PZ2x6x100 mm

Set	€	🔧	📦
1203E/D6	30,00	1	012031006

1202E PH1x4,5x80-PH2x6x100 mm
1204E 0,4x2,5x60-0,5x3x100
0,8x4x100-1,0x5x125 mm

Set	€	🔧	📦
1203E/D7	36,50	1	012031007

1201E 0,5x3x75-0,8x4x100
1,0x5,5x100-1,2x6,5x150 mm
1202E PH0x3x60-PH1x4,5x80
PH2x6x100 mm

Set	€	🔧	📦
1203E/D8	46,50	1	012031008

1201E 0,5x3x75-0,8x4x125
1,0x5,5x150-1,2x6,5x150 mm
1202E PH0x3x60-PH1x4,5x80
PH2x6x100-PH3x8x150 mm

Set	€	🔧	📦
1203E/D8P	40,50	1	012031018

1201E 2,5x50-3x75-4x100-5,5x100-
6,5x150 mm
1202E PH0x60-PH1x80-PH2x100 mm

Set	€	🔧	📦
1203E/D10	59,00	1	012031010

1201E 0,4x2,5x50-0,5x3x75
0,8x4x100-1,0x5,5x100
1,2x6,5x150-1,2x8x150 mm
1202E PH0x3x60-PH1x4,5x80
PH2x6x100-PH3x8x150 mm

Set	€	🔧	📦
1203E/D10N	51,50	1	012031019

1201E 0,4x2,5x50-0,5x3x75-0,8x4x100-
1,0x5,5x150-1,2x6,5x150 mm
1201EN 0,8x4x30 mm
1202E PH0x3x60-PH1x4,5x80-
PH2x6x100 mm
1202EN PH1x4,5x30 mm

Beta
Quality Tools



1203E/S



1203E/S € 40,50 1 012031009

1201E 2,5x50-3x75-4x100-5,5x125-6,5x150 mm
1202E PH0x3x60-PH1x4,5x80-PH2x6x100 mm

1203E/S10 € 59,50 1 012031021

1201E 0,4x2,5x50-0,5x3x75
0,8x4x125-1,0x5,5x150
1,2x6,5x150-1,2x8x150 mm
1202E PH0x3x60-PH1x4,5x80
PH2x6x100-PH3x8x150 mm

1204E

screwdriver for headless slotted screws

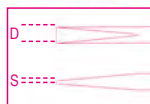

ISO 2380

SxDxL mm	L1 mm	€	Icons	Part No.
0,4x2,5x60	156	3,90	5	012041003
0,6x3x75	175	4,00	5	012041006
0,5x3x100	196	4,10	5	012041009
0,8x4x100	196	4,55	5	012041012
0,8x4x125	233	4,75	5	012041015
1x5x125	234	5,55	5	012041018
1x5x150	258	6,05	5	012041021
1,2x6,5x150	270	6,55	5	012041024



1204E/S5 € 24,70 1 012041205

0,4x2,5x60-0,5x3x100
0,8x4x100-1x5x125
1,2x6,5x150 mm

1204EL

screwdriver for headless slotted screws, long series

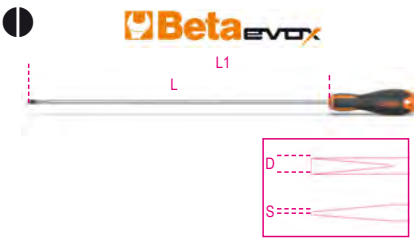

ISO 2380

SxDxL mm	L1 mm	€	Icons	Part No.
0,5x2,5x200	300	5,70	3	012041303
0,5x3x300	400	6,80	3	012041306
0,8x4x400	508	8,40	3	012041309
1x5x400	508	8,95	3	012041315
1,2x6,5x400	519	11,40	3	012041318

1205E/ES

hexagon drivers with handles



mm	L mm	L1 mm	€	Icons	Part No.
1,5	100	200	4,85	3	012051315
2	100	200	5,00	3	012051320
2,5	100	200	5,05	3	012051325
3	100	200	5,25	3	012051330
4	100	208	6,00	3	012051340
5	100	219	7,20	3	012051350
6	125	244	7,40	3	012051360
8	150	277	9,85	2	012051380



1205E/ES-S8 € 50,50 1 012051408

1,5-2-2,5-3-4-5-6-8 mm

1206E/BP

ball head hexagon drivers with handles



mm	L mm	L1 mm	Ø mm	€	Icons	Part No.
2	100	198	2,5	5,45	3	012061320
2,5	100	198	3,0	5,50	3	012061325
3	100	198	3,5	5,60	3	012061330
4	100	209	5,0	6,35	3	012061340
5	100	220	6,0	7,60	3	012061350
6	125	245	7,0	7,80	3	012061360
8	150	287	9,5	10,50	2	012061380



1206E/BP-S7 € 49,00 1 012061407

2-2,5-3-4-5-6-8 mm

1207E/TX

screwdrivers for Torx® head screws, with handles



	L mm	L1 mm	Ø mm	€	Icons	Part No.
T5	50	150	3	5,80	5	012071005
T6	60	156	4	6,20	5	012071006
T7	60	156	4	6,35	5	012071007
T8	60	156	4	6,45	5	012071008
T9	60	156	4	6,70	5	012071009
T10	80	189	5	7,60	5	012071010
T15	80	189	5	7,70	5	012071015
T20	100	209	5	7,80	5	012071020
T25	100	209	5	8,05	5	012071025
T27	100	220	6	8,55	5	012071027
T30	100	220	6	8,65	5	012071030
T40	130	262	7	10,30	2	012071040
T45	130	262	8	11,20	2	012071045



1207E/TX-D7 € 52,50 1 012071207

T6-T8-T10-T15

T20-T25-T30

1207E/TX-D13 € 101,50 1 012071213

T5-T6-T7-T8-T9-T10-T15
T20-T25-T27-T30-T40-T45

1208E/RTX

screwdrivers for Tamper Resistant Torx® head screws, with handles



	L mm	L1 mm	Ø mm	€	Icons	Part No.
T9	60	156	4	6,80	5	012081009
T10	80	189	5	7,60	5	012081010
T15	80	189	5	8,05	5	012081015
T20	100	209	5	8,20	5	012081020
T25	100	209	5	8,40	5	012081025
T27	100	220	6	9,10	5	012081027
T30	100	220	6	9,50	5	012081030
T40	130	262	7	11,30	2	012081040

**Beta** *evox*

1208E/RTX-D7 € 57,50 1 012081207
 T9-T10-T15-T20
 T25-T27-T30

1209E/PZ

screwdriver for cross head
 Pozidriv®-Supadriv® screws

**Beta** *evox*

UNI-ISO 8764

PZ	L mm	L1 mm	€		
0	60	156	4,55	5	012091000
1	80	189	5,90	5	012091003
2	100	220	7,60	5	012091006
3	150	282	11,60	3	012091009
4	200	327	12,80	3	012091012

**Beta** *evox*

1209E/PZ-S4 € 29,50 1 012091204
 PZ0-PZ1-PZ2-PZ3

1209EN/PZ

screwdriver for cross head Pozidriv®-Supadriv®
 screws,
 extra-short series

**Beta** *evox*

ISO 8764

PZ	L mm	L1 mm	€		
1	30	87	5,40	3	012091103
2	30	87	5,70	3	012091106

1229LP

micro-screwdrivers
 for headless slotted screws



D mm	L mm	L1 mm	€		
1,0	17	75	4,00	5	012290210
1,2	21	85	4,00	5	012290212
1,4	21	89	4,00	5	012290214
1,8	23	94	4,00	5	012290218
2,0	23	98	4,00	5	012290220
2,4	26	103	4,00	5	012290224
3,0	28	108	4,75	5	012290230



1229LP/A6 € 23,90 1 012290300
 1,2-1,4-1,8-2,2-4-3 mm

1229PH

micro-screwdrivers for cross head
 Phillips® screws



PH	L mm	L1 mm	€		
0	26	102	4,45	5	012290250
1	29	107	4,65	5	012290251

1229LPH/A6

set of 6 micro-screwdrivers
 items 1229LP-1229PH



	€		
1229LPH/A6	23,90	1	012290310
1229LP		1,4-2,0-2,4-3 mm	
1229PH		PH0-PH1	

1236B

offset screwdrivers
 for slotted head screws



UNI 7079 DIN 5200

SxA mm	L mm	€		
0,8x4	100	6,80	5	012360201
1x5,5	125	7,90	5	012360202
1,2x8	150	9,85	5	012360204

1238B

offset screwdrivers
 for cross head Phillips® screws



UNI 7083 DIN 5208

PH	L mm	€		
1-2	125	8,05	5	012380201
3-4	200	13,10	5	012380203

1241

screwdrivers with steel head for slotted head
 screws

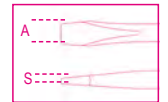
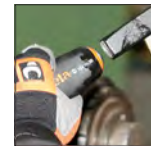

ISO 2380

SxAxL mm	L1 mm	€		
1x5,5x100	202	10,60	5	012410039
1,2x6,5x125	240	11,80	5	012410050
1,2x8x150	268	14,40	3	012410057
1,6x10x200	325	18,40	2	012410066

1242

screwdrivers with steel head for cross head
 Phillips® screws

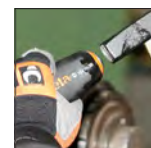

UNI/ISO 8764

PHxDxL mm	L1 mm	€		
1x4,5x100	202	10,50	5	012420209
2x6x100	215	12,40	5	012420218
3x8x150	268	15,80	3	012420221
4x11x200	325	20,70	2	012420224



1243/D7

Set of 7 screwdrivers with steel heads



1243/D7 € 94,00 1 012430017

1241	1x5,5x100-1,2x6,5x125
	1,2x8x150-1,6x10x200 mm
1242	PH1x4,5x100-PH2x6x100
	PH3x8x150 mm

1250

screwholding screwdrivers for slotted head screws

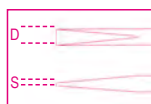

SxDxL mm	L1 mm	€	5	1
0,5x3x125	190	15,10	5	012500030
0,6x4x125	225	16,30	5	012500040
0,7x5x150	255	19,20	5	012500050

1251

screwholding screwdrivers for cross head Phillips® screws



PHxDxL mm	L1 mm	€	5	1
0x4x125	225	16,90	5	012510000
1x5x150	255	19,70	5	012510010
2x6x175	280	22,70	5	012510020

1252/S5



1252/S5 € 93,00 1 012520001

1250	0,5x3x125-0,6x4x125
	0,7x5x150 mm
1251	PH1x5x150-PH2x6x175 mm

1253

mains testing screwdriver 150/250V

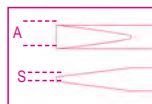

SxAxL mm	L1 mm	€	5	1
0,5x3,5x100	190	9,10	5	012530001

1253A

mains testing screwdriver 125/250V, double insulation

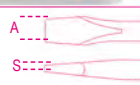

SxAxL mm	L1 mm	€	5	1
0,5x3x15	150	6,45	5	012530010

1254

circuit testing screwdriver 6-24V

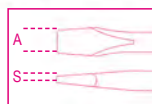

SxAxL mm	L1 mm	€	5	1
0,5x3x44	123	10,00	5	012540001

1256/C36-2

microscrewdriver with 36 interchangeable 4-mm bits and magnetic extension



1256/C36-2 € 64,50 1 012560100

1256TX	T3 - T4 - T5 - T6 - T7
	T8 - T9 - T10 - T15
1256RTX	T6 - T7 - T8 - T9 - T10
1256LP	0,8 - 1,2 - 1,5 - 1,8 - 2 - 2,5
	3 - 3,5 - 4 mm
1256PE	0,7 - 0,9 - 1,3 - 1,5 - 2 mm
1256PH	PH000 - PH00 - PH0 - PH1
1256PZ	PZ000 - PZ00 - PZ0 - PZ1
1256/20	
1256/30	

130x60x35 mm - 200 g

1256LP

4-mm bits for slotted head screws



SxA mm	L mm	€	5	1
0.25x0.8	27	1,25	5	012560001
0.25x1.2	27	1,25	5	012560002
0.3x1.5	27	1,25	5	012560003
0.35x1.8	27	1,25	5	012560004
0.4x2.0	27	1,25	5	012560005
0.4x2.5	27	1,25	5	012560006
0.5x3.0	27	1,25	5	012560007
0.6x3.5	27	1,25	5	012560008
0.8x4.0	27	1,25	5	012560009

1256PH

4-mm bits for cross head Phillips® screws



PH	L mm	€	5	1
000	27	1,25	5	012560011
00	27	1,25	5	012560012
0	27	1,25	5	012560013
1	27	1,25	5	012560014

1256PZ

4-mm bits for slotted head Pozidriv® - Supradriv® screws



PZ	L mm	€	5	1
000	27	1,25	5	012560061
00	27	1,25	5	012560062
0	27	1,25	5	012560063
1	27	1,25	5	012560064

1256PE

4-mm bits for hexagon head screws



mm	L mm	€	5	1
0.7	27	1,25	5	012560021
0.9	27	1,25	5	012560022
1.3	27	1,25	5	012560023
1.5	27	1,25	5	012560024
2.0	27	1,25	5	012560025

1256TX

4-mm bits
for Torx® head screws



Symbol	L mm	€	Hand	Computer	Part No.
T3	27	1,30	5		012560041
T4	27	1,30	5		012560042
T5	27	1,30	5		012560043
T6	27	1,30	5		012560044
T7	27	1,30	5		012560045
T8	27	1,30	5		012560046
T9	27	1,30	5		012560047
T10	27	1,30	5		012560048
T15	27	1,30	5		012560049

1256RTX

4-mm bits
for Tamper Resistant Torx® head screws



Symbol	L mm	€	Hand	Computer	Part No.
T6	27	1,55	5		012560051
T7	27	1,55	5		012560052
T8	27	1,55	5		012560053
T9	27	1,55	5		012560054
T10	27	1,55	5		012560055

1256/20

hexagon drive extension, 4 mm



Part No.	€	Hand	Computer
1256/20	7,80	5	012560092

1256/30

4-mm bit holder with handle



L mm	€	Hand	Computer
110	9,30	2	012560097

1257LP

micro-screwdrivers
for slotted head screws



SxD mm	L mm	€	Hand	Computer	Part No.
0,25x1,2	60	4,95	5		012570012
0,23x1,5	60	4,95	5		012570015
0,3x1,8	60	4,95	5		012570018
0,4x2	60	4,95	5		012570020
0,4x2,5	60	4,95	5		012570024
0,5x3	60	4,95	5		012570030
0,6x3,5	60	4,95	5		012570035
0,8x4	60	4,95	5		012570040

1257PH

micro-screwdrivers
for cross-head Phillips® screws



PH	L mm	€	Hand	Computer	Part No.
00	60	4,95	5		012570060
0	60	4,95	5		012570063
1	60	4,95	5		012570066

1257LPH/S8



Symbol	€	Hand	Computer
1257LPH/S8	62,50	1	012570210

1257PH PH00-PH0-PH1
1257LP 0,4x2-0,4x2,5-0,5x3
0,6x3,5-0,8x4 mm

1257ES

micro-screwdrivers hexagon male ends



mm	L mm	€	Hand	Computer	Part No.
0,9	60	5,55	5		012570045
1,3	60	5,55	5		012570046
1,5	60	5,55	5		012570047
2	60	5,55	5		012570048
2,5	60	5,55	5		012570049
3	60	5,55	5		012570050

1257ESB/S8



Symbol	€	Hand	Computer
1257ESB/S8	71,00	1	012570230

1257ES 0,9-1,3-1,5-2-2,5-3 mm
1257BE 4-5 mm

1257TX

micro-screwdrivers for Torx® head screws



Symbol	L mm	€	Hand	Computer	Part No.
T5	60	5,90	5		012570075
T6	60	5,90	5		012570076
T7	60	5,90	5		012570077
T8	60	5,90	5		012570078
T9	60	5,90	5		012570079
T10	60	5,90	5		012570080
T15	60	5,90	5		012570081
T20	60	5,90	5		012570082



Symbol	€	Hand	Computer
1257TX/S8	70,00	1	012570220

T5-T6-T7-T8
T9-T10-T15-T20

1257BE

micro-screwdrivers hexagon socket wrenches



mm	L mm	€	Hand	Computer	Part No.
3,2	60	7,40	5		012570085
4	60	7,40	5		012570086
5	60	7,40	5		012570087
5,5	60	7,40	5		012570088



The BetaGrip screwdrivers are the fruit of Beta's long expertise in screwdriver design and close cooperation with the mechanics of motor racing teams.

New, one-of-a-kind technical solutions capable of satisfying the most demanding professionals' requirements have been used with a view to achieving the highest standards as regards ergonomics, strength and quality of the materials.

- The **blade** is made from special steel with a high silicon, chromium and vanadium content, to ensure improved performance in terms of torsional and flexural strength. A non-glare, matt chrome-plated finish has been chosen.
- The **geometry of the tip** has been designed to ensure perfect coupling between the blade and the screw head. The phosphate-coated finish prevents the tip from getting oxidized, while maintaining precise profiles.
- The **texture** has been inspired by the treads of Racing tyres, developed to maximize grip on different grounds. Hence it ensures effective screwdriver hold under any working conditions, for enhanced precision and control when fitting the tip onto the screw.



1260

screwdrivers for slotted head screws



ISO 2380

SxAxL mm	L1 mm	Ø mm	€	⚙️	📦
0,4x2,5x50	150	2,5	5,10	5	012600003
0,4x2,5x75	175	2,5	5,30	5	012600006
0,5x3x75	175	3,0	5,45	5	012600009
0,5x3x100	200	3,0	5,60	5	012600012
0,6x3,5x75	175	3,5	5,80	5	012600018
0,6x3,5x100	200	3,5	5,90	5	012600021
0,8x4x100	208	4,0	6,45	5	012600030
0,8x4x125	233	4,0	6,70	5	012600033
0,8x4x150	258	4,0	6,95	5	012600036
1x5,5x100	208	5,0	7,40	5	012600039
1x5,5x125	233	5,0	7,50	5	012600040
1x5,5x150	258	5,0	8,20	5	012600042
1,2x6,5x100	219	6,0	8,85	5	012600048
1,2x6,5x125	244	6,0	9,15	5	012600050
1,2x6,5x150	269	6,0	9,50	5	012600051
1,2x8x150	277	8,0	11,70	3	012600057
1,2x8x200	327	8,0	12,10	3	012600060
1,6x10x200	327	9,5	14,70	3	012600066
2x12x250	377	10	17,30	3	012600069
2x14x250	377	10	18,40	2	012600073



1260/S6	€	⚙️	📦
0,4x2,5x75-0,5x3x75-0,8x4x125 1x5,5x150-1,2x6,5x150-1,2x8x200 mm	47,00	1	012600306

1260N

screwdrivers for slotted head screws, extra-short series



ISO 2380

SxAxL mm	L1 mm	Ø mm	€	⚙️	📦
0,8x4x30	87	4	6,80	5	012600103
1,2x6,5x30	87	6	7,50	5	012600106



1260E

screwdrivers for slotted head screws with hexagon bolsters



ISO 2380

SxAxL mm	L1 mm	Ø mm	€	🔧	📦
1,2x6,5x150	269	6,0	12,40	3	012600156
1,2x8x175	301	8,0	15,20	3	012600157
1,6x10x200	327	9,5	17,60	2	012600159
2x12x250	377	9,5	20,50	2	012600162

1260MC

screwdriver for slotted head screws, coloured



SxAxL mm	L1 mm	Ø mm	€	🔧	📦
0,4x2,5x50	150	2,5	5,50	3	012602003
0,6x3,5x75	175	3,5	5,70	3	012602018
0,8x4x100	208	4,0	6,80	3	012602030
1x5,5x125	233	5,0	8,65	5	012602040
1,2x6,5x150	269	6,0	10,00	5	012602051

1262

screwdrivers for cross head Phillips® screws



UNI/ISO 8764

PHxDxL mm	L1 mm	€	🔧	📦
0x3x60	160	5,45	5	012620003
0x3x100	200	5,75	5	012620006
1x4,5x80	188	7,15	5	012620009
1x4,5x120	228	7,70	5	012620012
2x6x100	219	8,75	5	012620018
2x6x150	269	9,65	5	012620021
3x8x150	277	12,90	3	012620024
4x10x200	327	16,50	3	012620027



1262/S4	€	🔧	📦
PH0x3x60-PH1x4,5x80 PH2x6x100-PH3x8x150 mm	34,00	1	012620304

1262N

screwdrivers for cross head Phillips® screws, extra-short series



UNI/ISO 8764

PHxDxL mm	L1 mm	€	🔧	📦
1x4,5x30	87	6,80	5	012620103
2x6x30	87	7,50	5	012620106

1262E

screwdrivers for cross head Phillips® screws with hexagon bolsters



UNI/ISO 8764

PHxDxL mm	L1 mm	€	🔧	📦
2x6x150	269	12,40	3	012620153
3x8x175	302	15,00	3	012620156
4x10x200	327	18,90	2	012620159

1262L

screwdrivers for cross head Phillips® screws, long series



UNI/ISO 8764-1

PHxDxL mm	L1 mm	€	🔧	📦
0x3x300	400	9,40	3	012620203
1x4,5x300	400	11,20	3	012620205
1x4,5x400	508	13,00	3	012620206
2x6x400	519	16,90	3	012620209

1262MC

screwdriver for cross head Phillips® screws, coloured



PHxDxL mm	L1 mm	€	🔧	📦
0x3x60	160	5,70	3	012622003
1x4,5x80	188	7,45	3	012622009
2x6x100	219	9,20	3	012622018

1263/D...

set of screwdrivers



1263/D6	€	🔧	📦
1260 0,5x3x75-0,8x4x100 1x5,5x125-1,2x6,5x150 mm 1262 PH1x4,5x80-PH2x6x100 mm	45,00	1	012630006



1263/D7	€	🔧	📦
1262 PH0x3x60 PH1x4,5x80 PH2x6x100 mm 1264 0,5x2,5x60-0,6x3x100 0,8x4x125-1x5x125 mm	46,00	1	012630017



1263/D7PZ	€	🔧	📦
1260 0,5x3x75-0,8x4x100 1x5,5x150-1,2x6,5x150 mm 1269PZ PZ0 - PZ1 - PZ2	53,50	1	012630007



1263/D8	€	🔧	📦
1260 0,4x2,5x50-0,5x3x75 0,8x4x100-1x5,5x125 1,2x6,5x150 mm 1262 PH0x3x60-PH1x4,5x80 PH2x6x100 mm	55,50	1	012630008



1263/D10	€	🔧	📦
1260 0,5x3x75-0,6x3,5x100 0,8x4x125-1x5,5x150 1,2x6,5x150 mm 1260N 0,8x4x30 1262 PH0x3x60-PH1x4,5x80 PH2x6x100 mm 1262N PH1x4,5x30	70,50	1	012630010

1263/S12

set of 12 screwdrivers



		€		
1263/S12		101,00	1	012630112
1260	0,4x2,5x50-0,5x3x75 0,6x3,5x100-0,8x4x125 1x5,5x125-1,2x6,5x150 1,2x8x200-1,6x10x200 mm			
1262	PH0x3x60-PH1x4,5x80 PH2x6x100-PH3x8x150 mm			

1263MC/D8

set of 8 coloured screwdrivers



		€		
1263MC/D8		59,00	1	012632008
1260MC	0,4x2,5x50-0,5x3x75 0,8x4x100-1x5,5x125 1,2x6,5x150 mm			
1262MC	PH0x3x60-PH1x4,5x80 PH2x6x100 mm			

1264

screwdrivers for headless slotted screws

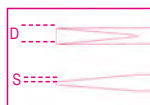

SxDxL mm	L1 mm	€		
0,5x2,5x60	160	5,10	5	012640003
0,6x3x75	175	5,45	5	012640006
0,6x3x100	200	5,60	5	012640009
0,8x4x100	208	6,45	5	012640012
0,8x4x125	233	6,70	5	012640015
1x5x125	233	7,50	5	012640018
1x5x150	258	7,90	5	012640021
1,2x6,5x150	269	9,50	5	012640024



		€		
1264/S5		34,00	1	012640305
0,5x2,5x60-0,6x3x75 0,8x4x100-1x5x125-1,2x6,5x150 mm				

1264L

screwdrivers for headless slotted screws, long series



SxDxL mm	L1 mm	€		
0,5x2,5x200	300	7,60	3	012640203
0,6x3x300	400	8,95	3	012640206
0,8x4x400	508	11,70	3	012640209
1x5x400	508	13,00	3	012640215
1,2x6,5x400	519	15,80	3	012640218

1265ES

hexagon drivers with handles



mm	L mm	L1 mm	€		
1,5	100	200	6,25	3	012650015
2	100	200	6,40	3	012650020
2,5	100	200	6,60	3	012650025
3	100	200	6,95	3	012650030
4	100	208	7,65	3	012650040
5	100	219	8,85	3	012650050
6	125	244	10,00	3	012650060
8	150	277	13,30	2	012650080



		€		
1265ES/S8		66,00	1	012650308
1,5-2-2,5-3-4-5-6-8 mm				

1266BP

ball head hexagon drivers with handles



mm	L mm	L1 mm	€		
2	100	200	6,80	3	012660020
2,5	100	200	7,05	3	012660025
3	125	225	7,40	3	012660030
4	125	233	8,20	3	012660040
5	120	239	9,50	3	012660050
6	140	259	11,00	3	012660060
8	160	287	13,90	2	012660080
10	160	287	16,80	2	012660100



		€		
1266BP/S8		80,50	1	012660308
2-2,5-3-4-5-6-8-10 mm				

1267TX

drivers for Torx® head screws, with handles



⊕	L mm	L1 mm	∅ mm	€		
T5	50	150	3	7,60	5	012670005
T6	50	150	3	7,90	5	012670006
T7	50	150	3	8,20	5	012670007
T8	60	160	3	8,55	5	012670008
T9	60	167	4	8,95	5	012670009
T10	80	188	4	9,30	5	012670010
T15	80	188	4	9,85	5	012670015
T20	100	208	4,5	10,40	5	012670020
T25	100	208	5	11,20	5	012670025
T27	115	234	6	11,70	5	012670027
T30	115	234	6	12,30	5	012670030
T40	130	257	7	14,30	2	012670040
T45	130	257	8	15,60	2	012670045



1267TX/D7
T6-T8-T10-T15
T20-T25-T30

€ 69,50 1 012670307



1267TX/S13
T5-T6-T7-T8-T9
T10-T15-T20-T25
T27-T30-T40-T45

€ 136,00 1 012670312

1267MC/TX

drivers for Torx® head screws, with handles, coloured



	L mm	L1 mm	Ø mm	€		
T6	50	150	3	8,40	5	012672006
T8	60	160	3	8,85	5	012672008
T10	80	188	4	9,75	5	012672010
T15	80	188	4	10,40	5	012672015
T20	100	208	4,5	11,00	5	012672020
T25	100	208	5	11,60	3	012672025
T30	115	234	6	12,80	3	012672030



1267MC/TX-D7
T6-T8-T10-T15
T20-T25-T30

€ 73,00 1 012672307

1268RTX

screwdrivers for Tamper Resistant Torx® head screws, with handles



	L mm	L1 mm	Ø mm	€		
T9	60	167	4,0	9,70	3	012680009
T10	80	188	4,0	10,10	3	012680010
T15	80	188	4,0	10,40	3	012680015
T20	100	208	4,5	11,20	3	012680020
T25	100	208	5,0	11,50	3	012680025
T27	115	234	6,0	12,30	3	012680027
T30	115	234	6,0	12,50	3	012680030
T40	130	257	7,0	14,50	2	012680040



1268RTX/S8
T9-T10-T15-T20
T25-T27-T30-T40

€ 92,00 1 012680307

1269PZ

screwdrivers for cross head Pozidriv®-Supadriv® screws



UNI/ISO 8764

PZ	L mm	L1 mm	€		
0	60	160	6,20	5	012690000
1	80	188	8,05	5	012690001
2	100	219	9,75	5	012690002
3	150	277	13,90	3	012690003
4	200	327	17,80	3	012690004



1269PZ/S4
PZ0-PZ1-PZ2-PZ3

€ 38,00 1 012690304

1269N/PZ

screwdrivers for cross head Pozidriv®-Supadriv® screws, extra-short series



UNI/ISO 8764

PZ	L mm	L1 mm	€		
1	30	87	6,80	5	012690011
2	30	87	7,50	5	012690012

1281BG

interchangeable blade screwdriver handle



L mm	Ø mm	€		
118	10	11,40	5	012810280

1281PM

quick-fit magnetic bit holder



L mm	€		
165	19,50	5	012810292

1281PB

socket holder with 1/4" male drive



L mm	€		
175	15,50	5	012810293

1281LP

reversible screwdrivers for slotted head screws



	€		
1281LP/1 0,8x4-1,2x6,5 mm	10,00	5	012810302
1281LP/2 1x5,5-1,2x6,5 mm	10,00	5	012810304

1281PH

reversible screwdrivers
for cross head Phillips® screws



PH	€	5	012810310
1-2	10,00		
2-3	10,00		5 012810312

1281LPH

reversible screwdrivers
for slotted and Phillips® head screws



	€	5	012810321
1281LPH/1 PH0-0,8x4 mm	10,00		
1281LPH/2 PH1-1x5,5 mm	10,00		5 012810322
1281LPH/3 PH2-1,2x6,5 mm	10,00		5 012810323

1281PZ

reversible screwdrivers
for cross head Pozidriv®-Supadriv® screws



PZ	€	5	012810330
1-2	10,00		
2-3	10,00		5 012810332

1281PE

reversible ball head hexagon
screwdriver blades



mm	€	5	012810342
2,5	9,85		
3	9,85		5 012810343
4	9,85		5 012810344
5	9,85		5 012810345
6	9,85		5 012810346

1281TX

reversible screwdrivers for Torx® head screws



	€	5	012810349
1281TX/1 T6-T8	10,90		
1281TX/2 T7-T9	10,90		5 012810350
1281TX/3 T10-T15	10,90		5 012810351
1281TX/4 T20-T25	10,90		5 012810352
1281TX/5 T30-T40	10,90		5 012810353

1281RTX

reversible screwdrivers
for Tamper Resistant Torx® head screws



	€	5	012810361
1281RTX/3 T10-T15	11,10		
1281RTX/4 T20-T25	11,10		5 012810362
1281RTX/5 T30-T40	11,10		5 012810363

1281BG/A9

assortment of 9 reversible screwdrivers
and 1 accessory in case



	€	1	012810520
1281BG/A9	116,50		

	1281BG
1281LPH/1	PH0-0,8x4 mm
1281LPH/2	PH1-1x5,5 mm
1281LPH/3	PH2-1,2x6,5 mm
1281PZ/1	PZ1-PZ2
1281PE	2,5 mm
1281PE	3 mm
1281PE	4 mm
1281PE	5 mm
1281PE	6 mm

1281BG-TX/A8

assortment of 8 reversible screwdrivers
and 1 accessory in case



	€	1	012810530
1281BG-TX/A8	111,50		

	1281BG
1281LPH/1	PH0-0,8x4 mm
1281LPH/2	PH1-1x5,5 mm
1281LPH/3	PH2-1,2x6,5 mm
1281TX/1	T6-T8
1281TX/2	T7-T9
1281TX/3	T10-T15
1281TX/4	T20-T25
1281TX/5	T30-T40

1281BG/B28NA

assortment of 16 reversible screwdrivers, 9
1/4" sockets, 2 accessories and 1 handle,
in durable polyester wallet



	€	1	012810511
1281BG/B28NA	259,00		

	900	4 - 4,5 - 5 - 5,5 6 - 7 - 8 - 9 - 10 mm
1281BG		
1281PB	■ 1/4	
900/25		
1281LP/1		0,8x4 - 1,2x6,5 mm
1281LP/2		1,0x5,5 - 1,2x6,5 mm
1281PH/1		PH1 - PH2
1281PH/2		PH2 - PH3
1281PZ/1		PZ1 - PZ2
1281PZ/2		PZ2 - PZ3
1281PE		2,5 - 3 - 4 - 5 - 6 mm
1281TX/1		T6 - T8
1281TX/2		T7 - T9
1281RTX/3		T10 - T15
1281RTX/4		T20 - T25
1281RTX/5		T30 - T40

	€	1	020020060
2002/BV7-ZIP	17,20		



Beta

The **BetaMax screwdrivers** rely on several technical characteristics to make work operations even easier.

- The handle is inspired by the triangular section, which ensures optimal screwing, based on a 120° range, in line with maximum wrist rotation.
- The design provides remarkable ergonomic properties, during both quick screwing and tightening operations.
- The chrome-plating free tip ensures perfect coupling with the screw and is protected from oxidation with phosphate-coating treatment.



1290

screwdrivers for slotted head screws



ISO 2380

SxAxL mm	L1 mm	Ø mm	€		
0,4x2,5x50	146	2,5	6,35	5	012900003
0,4x2,5x75	171	2,5	6,55	5	012900006
0,5x3x75	171	3,0	6,70	10	012900009
0,5x3x100	196	3,0	7,05	10	012900012
0,6x3,5x75	171	3,5	7,60	10	012900018
0,6x3,5x100	196	3,5	7,70	10	012900021
0,8x4x100	196	4,0	7,80	10	012900030
0,8x4x125	221	4,0	8,05	10	012900033
0,8x4x150	246	4,0	8,55	10	012900036
1x5,5x100	209	5,0	8,75	10	012900039
1x5,5x150	259	5,0	9,75	10	012900042
1,2x6,5x100	220	6,0	10,90	10	012900048
1,2x6,5x150	270	6,0	11,50	10	012900051
1,2x8x150	282	7,0	14,50	3	012900057
1,2x8x200	332	7,0	15,30	3	012900060
1,6x10x200	332	8,0	18,00	3	012900066
2x12x250	382	10	24,20	2	012900069

1290/S

screwdriver set



	€		
1290/S5	50,00	1	012900305

1290 0,5x3x75-0,8x4x100 -1x5,5x150
1,2x6,5x150 -1,2x8x150 mm

	€		
1290/S9X	94,50	1	012900319

1290 0,4x2,5x75 - 0,5x3,5x100
0,8x4x125 - 1x5,5x150
1,2x6,5x150 - 1,2x8x200
1,6x10x200 mm
1290N 0,8x4x30 -1,2x6,5x30 mm

1290N

screwdrivers for slotted head screws
extra short series



ISO 2380

SxAxL mm	L1 mm	Ø mm	€		
0,8x4x30	86	4	8,30	5	012900103
1,2x6,5x30	86	6	9,20	5	012900106

1292

screwdrivers for cross head
Phillips® screws



UNI/ISO 8764

PHxDxL mm	L1 mm	€		
0x3x60	156	6,10	10	012920003
0x3x100	196	6,95	5	012920006
1x4,5x80	189	8,40	10	012920009
1x4,5x120	229	9,30	10	012920012
2x6x100	220	11,00	10	012920018
2x6x150	270	11,90	10	012920021
3x8x150	282	15,10	3	012920024
4x10x200	332	20,90	3	012920027



	€		
1292/S4 PH0x3x60-PH1x4,5x80 PH2x6x100-PH3x8x150 mm	40,50	1	012920304

1292N

screwdrivers for cross head
Phillips® screws
extra short series



UNI/ISO 8764

PHxDxL mm	L1 mm	€		
1x4,5x30	86	7,90	5	012920103
2x6x30	86	8,65	5	012920106

1292L

screwdrivers for cross head
Phillips® screws, long series



UNI/ISO 8764-1

PHxDxL mm	L1 mm	€		
0x3x300	396	13,50	3	012920203
1x4,5x400	509	16,80	3	012920206
2x6x400	520	20,50	3	012920209

1293/D...
screwdriver set



1293/D6	€ 54,50	1	012930401
1290	0,6x3,5x75-1x5,5x150 1,2x6,5x150 mm		
1292	PH0x3x60 -PH1x4,5x80 PH2x6x100 mm		

1293/D8	€ 75,50	1	012930403
1290	0,5x3x75-0,8x4x100 1x5,5x150-1,2x6,5x150 1,2x8x150 mm		
1292	PH0x3x60 -PH1x4,5x80 PH2x6x100 mm		

1293/S...
screwdriver set



1293/S8	€ 67,50	1	012930208
1290	2,5x50-3x75-4x100-5,5x150 6,5x150 mm		
1292	PH0x3x60 -PH1x4,5x80 PH2x6x100 mm		

1293/S10	€ 107,50	1	012930201
1290	0,4x2,5x50 -0,6x3,5x100 1x5,5x100-1,2x6,5x150 1,2x8x150-1,6x10x200 mm		
1292	PH0x3x60 -PH1x4,5x80 PH2x6x100-PH3x8x150 mm		

1293/S12	€ 116,50	1	012930203
1290	0,5x3x75-0,8x4x125 1x5,5x150-1,2x6,5x150 1,2x8x200 mm		
1290N	0,8x4x30 mm		
1292	PH0x3x60 -PH1x4,5x80 PH2x6x100-PH3x8x150 mm		
1292N	PH1x4,5x30-PH2x6x30 mm		

1293/S7	€ 55,50	1	012930207
1292	PH0x3x60 -PH1x4,5x80 PH2x6x100 mm		
1294	0,5x2,5x60-0,6x3x75 0,8x4x100-1x5x125 mm		



1293ES
hexagon drivers with handles



mm	L mm	L1 mm	Ø mm	€	1	012930001
2	100	196	3	8,55	5	012930001
2,5	100	196	4	8,55	5	012930002
3	100	196	4	8,85	5	012930003
4	100	196	5	10,00	5	012930004
5	100	209	6	11,00	5	012930005
6	125	245	7	12,50	5	012930006
8	150	282	10	16,80	2	012930008



1293ES/S7 2-2,5-3-4-5-6-8 mm € 76,00 1 012930057

1293BP
ball head hexagon drivers with handles



mm	L mm	L1 mm	€	5	012930501
2	100	196	8,65	5	012930501
2,5	100	196	8,65	5	012930502
3	100	196	8,95	5	012930503
4	100	196	10,00	5	012930506
5	100	209	11,00	5	012930509
6	125	245	12,80	5	012930512
8	150	282	17,40	2	012930515



1293BP/S7 2-2,5-3-4-5-6-8 mm € 77,50 1 012930558

1294
screwdrivers for headless slotted screws



SxDxL mm	L1 mm	€	5	012940003
0,5x2,5x60	156	5,95	5	012940003
0,6x3x75	171	6,25	5	012940006
0,6x3x100	196	6,45	5	012940009
0,8x4x100	196	7,80	5	012940012
0,8x4x150	246	10,20	5	012940015
1x5x125	234	9,85	5	012940018
1,2x6,5x150	282	11,60	5	012940027



1294/S5 0,5x2,5x60-0,6x3x100
0,8x4x100-1x5x125
1,2x6,5x150 mm € 41,50 1 012940305

1294L
screwdrivers for headless slotted screws long series

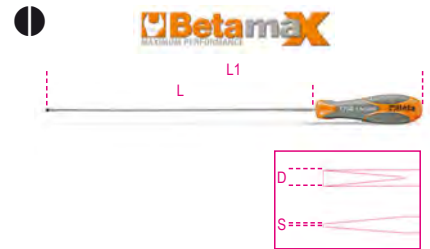

SxDxL mm	L1 mm	€	3	012940206
0,6x3x300	396	12,90	3	012940206
0,8x4x400	496	15,30	3	012940209
1x5x400	509	18,80	3	012940215
1,2x6,5x400	532	21,00	3	012940218

1295
impact screwdriver



1295 L mm 130 € 57,00 1 012950001

1295/C14

impact screwdriver
with 14 insets and 1 socket holder



1295/C14 € 135,50 1 012950108

	866LP	1,2x6,5 - 1,6x10 mm
	866PH	PH2 - PH3
	866PZ	PZ2 - PZ3
	866PE	5 - 6 mm
	866TX	T27 - T30 - T40 - T45 - T50 - T55
	895/6	□ 1/2 - ○ 5/16
	1295	■ 1/2

170x100x35 mm - 1,3 kg

1297TX

drivers for Torx® head screws,
with handles



⊕	L mm	L1 mm	∅ mm	€	U	PC
T6	50	146	3,0	11,20	5	012970006
T7	50	146	3,0	11,40	5	012970007
T8	60	156	3,0	11,50	5	012970008
T9	60	169	4,0	12,00	5	012970009
T10	80	189	4,0	12,70	5	012970010
T15	80	189	4,0	12,80	5	012970015
T20	100	209	4,5	13,10	5	012970020
T25	100	209	5,0	13,60	5	012970025
T27	115	235	6,0	14,00	5	012970027
T30	115	235	6,0	14,80	5	012970030
T40	130	262	7,0	16,50	2	012970040
T45	130	262	8,0	18,70	2	012970045



1297TX/S12 € 162,50 1 012970312
T6-T7-T8-T9-T10
T15-T20-T25-T27
T30-T40-T45



Betamax
MAXIMUM PERFORMANCE



1297TX/D6 € 81,00 1 012970409
T10-T15-T20
T25-T27-T30

1297TX/L

drivers for Torx® head screws, long series



⊕	L mm	L1 mm	∅ mm	€	U	PC
T15	210	319	4,0	14,30	2	012970115
T20	210	319	4,5	14,70	2	012970120
T25	210	319	5,0	15,10	2	012970125
T30	210	330	6,0	16,30	2	012970130
T45	210	342	8,0	17,60	2	012970145



Betamax
MAXIMUM PERFORMANCE



1297TX/L-S5 € 78,00 1 012970325
TX/L15-TX/L20-TX/L25-
TX/L30-TX/L45

1298RTX

screwdrivers for Tamper Resistant Torx®
head screws, with handles



⊕	L mm	L1 mm	∅ mm	€	U	PC
T9	60	169	4,0	13,10	5	012980009
T10	80	189	4,0	13,40	5	012980010
T15	80	189	4,0	14,30	5	012980015
T20	100	209	4,0	14,40	5	012980020
T25	100	209	4,5	14,70	5	012980025
T27	115	235	5,5	15,80	5	012980027
T30	115	235	6,0	16,50	5	012980030
T40	130	262	7,0	17,60	2	012980040



Betamax
MAXIMUM PERFORMANCE



1298RTX/S8 € 120,00 1 012980308
T9-T10-T15-T20
T25-T27-T30-T40

1299PZ

screwdrivers for cross head
Pozidriv®-Supadriv® screws



UNI/ISO 8764

PZ	L mm	L1 mm	€	U	PC
0	60	156	8,75	5	012990000
1	80	189	10,30	5	012990003
2	100	220	14,00	5	012990006
3	150	282	20,30	2	012990009
4	200	332	28,50	2	012990012



Betamax
MAXIMUM PERFORMANCE



1299PZ/S6 € 74,50 1 012990306
1299PZ PZ0-PZ1-PZ2-PZ3
1299N/PZ PZ1-PZ2

1299N/PZ

screwdrivers for cross head
Pozidriv®-Supadriv® screws
extra short series



UNI/ISO 8764

PZ	L mm	L1 mm	€	U	PC
1	30	86	10,00	5	012990021
2	30	86	11,00	5	012990024

Beta
Quality Tools

VEHICLE REPAIR

Our vehicle repair tools, which are used by the most demanding professionals, are developed and manufactured to meet the world's highest standards, and regularly tested under the most stressful operating conditions.

For over 50 years, we have been proudly working hand in hand with the greatest champions, who help us improve our products non-stop and provide testimony to the highest quality standard.

The vehicle repair tools are found in these sections:

Diagnostics	items 1438 to 1499 items 1758VT to 1760TMC
Engine	items 955 to 989A items 1438 to 1499
Oil and filters	items 1438 to 1499 items 1877 to 1885
Electric system	items 1438 to 1499
Transmission	items 1438 to 1499
Suspension	items 1549 to 1569CP
Brakes	items 1438 to 1499
Wheels	items 955 to 989A
Body work	items 1302 to 1369 items 1763 to 1767A
Other equipment	items 1878 to 3067



1302
double end dolly, round,
convex peim head



g 770 € 88,50 1 013020001

1303
curved dolly



g 1350 € 67,00 1 013030001

1304
sole dolly



g 875 € 84,50 1 013040001

1305
toe dolly



g 1190 € 53,50 1 013050001

1305Z
milled toe dolly



g 1065 € 63,50 1 013050002

1306
heel dolly



g 1040 € 50,00 1 013060001

1307
regular dolly

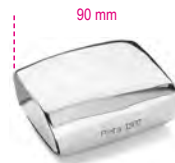

g 1100 € 98,50 1 013070001

1308
egg dolly



g 1100 € 92,00 1 013080001

1309
hatchet dolly



g 460 € 59,00 1 013090001

1310
general purpose dolly



g 1225 € 56,50 1 013100001

1312
anvil dolly



g 1220 € 121,50 1 013120001

1313
buffer dolly

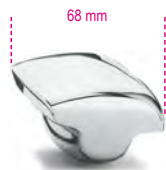

g 990 € 82,00 1 013130001

1314
double end dolly, convex, flat head



g 760 € 54,00 1 013140001

1326
curved angle spoon



g 560 € 48,00 1 013260001

1327
heavy-duty spoon



g 1075 € 67,50 1 013270001

1328
pry and bumping spoon



g 935 € 61,00 1 013280001

1329
double-ended spoon



g 1800 € 186,50 1 013290001

1330
long double-ended spoon



g 2125 € 198,50 1 013300001

1331
bending iron with leather face



g 1100 € 110,00 1 013310001

1335BM
bumping blade with plastic handle



g 500 € 32,50 2 013350010

1337/S5
set of 5 stopping knives for car repairers, made of stainless steel

Japanese type
(25-50-75-100-125 mm)



L mm 25-50-75-100-125 € 12,40 1 013370015

1338A - 1338B
adjustable body blade holder with flexible flat blades



	W/1"	L mm	€		
1338A	9	360	91,50	2	013380001
1338B	12	360	95,50	2	013380002

1338
body blade holder for item 1338R



1338 € 49,50 2 013380003

1338R9 - 1338R12
spare body blades for item 1338A-B



	W/1"	€		
1338R9	9	42,00	2	013380004
1338R12	12	46,00	2	013380005

1342
extra flat chisel with straight cutter



L mm 235 € 28,50 5 013420001

1342PM

extra flat chisel with straight cutter with hand guard

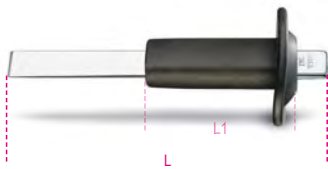

L mm	L1 mm	€	🔧	📦
235	118	40,50	2	013420002

1342PMR

spare hand guard for item 1342



1342PMR	€	🔧	📦
	11,90	1	013420003

1343

flat chisel with side cutter



L mm	€	🔧	📦
200	30,00	5	013430001

1344

feeler gauges for car body repair shops, pair, 10-bladed, with suction cup

suitable for:
• fitting rear windows
• maintaining position during installation



1344	€	🔧	📦
	35,00	1	013440010

1344A/VW

fixing hook removal tool for Volkswagen handles



L mm	€	🔧	📦
260	15,80	1	013440100

1345

hammer with round, convex face and pein, wooden shaft



1345	€	🔧	📦
	42,00	2	013450010

1351

hammer with round, flat face and ball pein, wooden shaft



1351	€	🔧	📦
	42,50	2	013510010

1353

hammer with round, flat face and point pein, wooden shaft



1353	€	🔧	📦
	44,00	2	013530010

1357Z/45

hammers with flat, round, milled face and square, smooth face, wooden shafts



1357Z/45	€	🔧	📦
	69,50	2	013570045

1359T

hammer with round, flat face and horizontal pein, wooden shaft



1359 T	€	🔧	📦
	41,50	2	013590010

1360G

soft dead-blow rubber hammer, for installing gaskets and delicate parts

The extremely soft faces prevent any parts being worked on from getting damaged, as they absorb impact by getting deformed.



L mm	Ø mm	€	🔧	📦
280	72	70,00	1	013600000

1360/K6

aluminium hammer with flat, round face, interchangeable plastic pins and punch

supplied with:
• 4 plastic pins
• 1 punch, adjustable in 2 different lengths, applicable to hammer



L mm	Ø mm	€	🔧	📦
320	34	80,50	1	013600006

1360/KP3

hammers with ball heads and point peins/punches, made of plastic

Kit contents:
• 1 210 g hammer with head Ø 30 mm
• 1 290 g hammer with head Ø 40 mm
• 1 75 g punch with 5 mm pein



1360/KP3	€	🔧	📦
	77,00	1	013600503

1361/C12

set of Teflon® rods for body repair shops



1361/C12	€	🔧	📦
	121,50	1	013610012

📏 275x160x57 mm

1362

dent reflector
with suction cup

allows even the smallest
bodywork imperfections to be detected



LxH
mm
1362 240 x200 € 75,00 1 013620010

1365/K13

oil pressure pump, 10 t, and bodywork
accessories kit
in trolley

Kit contents:

- oil pressure pump, 10 t, with 1.5-m-long hose, 1/2" coupling
- piston
- wing opening pliers; capacity: 500 kg
- baseplate, 150x90 mm
- L-shaped base, 50x50 mm
- 4-point punch
- round, knurled punch, Ø 50 mm
- wedge-shaped punch, 43 mm
- 240-mm-long extension
- 450-mm-long extension
- 475-mm-long extension
- rubber head
- male-to-male coupling for installing accessories



1365/K13 642,00 1 013650013
≡ 900x420x180 mm

1365P10

oil pressure pump

1.5-m-long hose, 1/2" coupling



1365P10 286,00 1 013650110

1366A

dent puller
with kit of 19 plastic glue tabs

ideal for removing:

- hail dents
- dents caused by doors
- small dents in general



1366A 84,00 1 013660200

1366B

hammer face for plastic
dent pulling glue tabs

hammer face weight: 500 g



L
mm
440 € 46,50 1 013660250

1366KF

kit of 19 plastic glue tabs
for item 1366A



1366KF 30,50 1 013660205

1366/K5

pneumatic dent puller, with 1.1 kg hammer
face

Kit contents:

- 1 suction cup Ø 75 mm
- 1 suction cup Ø 100 mm
- 1 suction cup Ø 125 mm
- 1 hook



1366/K5 220,00 1 013660010
≡ 610x240x90 mm

1366S

wheeled bodywork spotter

- microprocessor for managing welding parameters
- welding power and time adjustment
- adjustment range: 400÷2200 Ah
- single, pulsed, continuous point selector
- welding parameters table
- thermal protection indicator
- quick coupling gun
- voltage: 230 V

CE



1366S 1.520,00 1 013660000

1366S KIT

spotter accessory kit

- 10 slotted washers
- 10 90°slotted washers
- 100 threaded pins, 5x18 mm
- 100 self-threading pins, 5x18 mm
- 100 self-threading pins, 5x25 mm
- washer hook, Ø 8x16x1.5 mm
- electrode for M5-M6 screws
- electrode for slotted washers



1366S KIT 202,00 1 013660001
≡ 250x170x35

1366SL

pulling lever
for repairing dents on metal surfaces

articulated multihook head
for use with crimped wire



L
mm
700 € 176,00 1 013660002

1366ST

crossbar
for repairing dents on metal surfaces

articulated multihook head
for use with crimped wire



L
mm 850 € 559,00 1 013660003

1366S/R1

3-pointed washer mandrel



1366S/R1 € 21,90 1 013660501

1366S/R2

3-pointed washer
for pulling sheets



1366S/R2 € 21,90 1 013660502

Stated prices are for 20 pieces

1366S/R3

electrode for washers
Ø 8x16x1.5 mm



1366S/R3 € 26,50 1 013660503

1366S/R4

washer hook, Ø 8x16x1.5 mm



1366S/R4 € 23,10 1 013660504

1366S/R5

washers Ø 8x16x1.5mm



1366S/R5 € 12,70 1 013660505

Stated prices are for 100 pieces

1366S/R6

electrode for M5-M6 screws



1366S/R6 € 25,50 1 013660506

1366S/R7

100 self-threading pins, 5x18 mm



1366S/R7 € 21,90 1 013660507

1366S/R8

100 self-threading pins, 5x25 mm



1366S/R8 € 30,00 1 013660508

1366S/R9

100 threaded pins, M5 x 18 mm



1366S/R9 € 20,30 1 013660509

1366S/R10

10 slotted washers



1366S/R10 € 14,00 1 013660510

1366S/R11

electrode for slotted washers



1366S/R11 € 71,50 1 013660511

1366S/R12

10 90° slotted washers



1366S/R12 € 28,00 1 013660512

1366S/R13

sheet flattening electrode



1366S/R13 € 51,50 1 013660513

Stated prices are for 5 pieces

1366S/R14

wire spot welding electrode



1366S/R14 € 25,00 1 013660514

1366S/R21

crimped wires for use of
pulling lever and crossbar



1366S/R21 € 17,30 1 013660551

Stated prices are for 10 pieces

1366S/R22

magnetic support
for crimped wire



1366S/R22 € 60,00 1 013660552

1366S/R24

pull ring M4



1366S/R24 € 69,00 1 013660554

Stated prices are for 5 pieces

1366S/R25

pull ring M5



1366S/R25 € 69,00 1 013660555

Stated prices are for 5 pieces

1366S/R26

pull ring M6



1366S/R26 € 69,00 1 013660556

Stated prices are for 5 pieces

1367/S4

set of punches for installing parking sensors

sizes:

23 - 24 - 27 - 28



1367/S4 € 202,00 1 013670104

1367/K10

kit of punches for installing parking sensors

Kit contents:

• sizes: 17 - 18 - 18.2 - 19 - 20 - 22.5 - 24 - 26 - 26.7 - 32 mm



Ø 12 mm

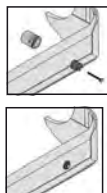

1367/K10 € 170,00 1 013670200

190x130x58 mm

1368

plastic repair kit

• Allows cracked and broken plastic parts to be quickly fixed

Power supply: 220÷240 V with Schuko socket

Heat gun cable length: 3.5 m

Power supply cable length: 1.35 m

2 power adjustments: 35-75 W

Heat gun with brass terminals, 2 staple insertion angles: 0°-90°

Input protection: thermal circuit breaker

Output protection: 10 A fuse

Metal gun pocket

CE



1368 € 397,00 1 013680001

1368G/K400

assortment of 400 clips for item 1368



1368G/K400 € 67,50 1 013680140

1368G/OD

corrugated clips, straight, for item 1368



1368G/OD € 16,90 1 013680100

The prices shown are for 100 pieces

1368G/SD

spiral clips, straight, for item 1368



1368G/SD € 16,90 1 013680110

The prices shown are for 100 pieces

1368G/CV

convex angle clips for item 1368



1368G/CV € 16,90 1 013680120

The prices shown are for 100 pieces

1368G/C2U

concave angle clips for item 1368



1368G/C2U € 16,90 1 013680130

The prices shown are for 100 pieces

1369/C11

assortment of 11 tools



1369/C11 € 760,00 1 013690033

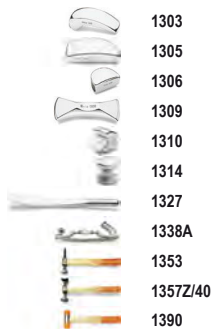

470x340x70 mm - 15,2 kg

1370

engineer's hammers, wooden shaft



HICKORY

UNI 7778 DIN 1041

g	A mm	L mm	L1 mm	€		
100	15	260	82	11,20	5	013700051
200	19	280	95	12,70	5	013700052
300	23	300	105	14,50	5	013700053
400	25	310	112	16,40	5	013700054
500	27	320	118	17,60	5	013700055
600	30	330	122	20,50	5	013700056
800	33	350	130	23,10	4	013700058
1000	36	360	135	27,50	4	013700060
1500	42	380	145	31,50	2	013700065
2000	47	400	155	37,00	1	013700070

Beta

Beta

HAMMER HANDLES

Handles made from **hickory** wood
Hickory is a type of wood with excellent properties, which suit hammer handles perfectly. Its long fibre structure absorbs vibration and makes it extremely resistant to breakage. In the unlikely event that some fibres should break, the risk that the head will suddenly come off is very small anyway.

Wood handles can be replaced when worn.

As wood is a natural material, it should retain its own moisture. Therefore, the hammer should not be stored in an excessively dry place.

Handles made from **fibreglass**
Handles with fibreglass core are both durable and safe; the risk of breakage and injuries is reduced to a minimum.

They are weathertight and resistant to the most common chemicals.



- **Indestructible fibreglass core**

- **Ergonomic polypropylene frame**

- **Nonslip, comfortable elastomer coating**

1370/MR...

spare shafts for item 1370

	€	🔧	📄
1370MR 100 1370/100	5,05	4	013700081
1370MR 200 1370/200	5,60	4	013700082
1370MR 300 1370/300	6,10	4	013700083
1370MR 400 1370/400	6,55	4	013700084
1370MR 500 1370/500	7,20	4	013700085
1370MR 600 1370/600	7,90	4	013700086
1370MR 800 1370/800	8,30	4	013700088
1370MR 1000 1370/1000	8,85	4	013700090
1370MR 1500 1370/1500	10,00	4	013700095
1370MR 2000 1370/2000	11,20	4	013700100

1370T

mechanic's hammers
fibre shaft



🔧	A mm	L mm	L1 mm	€	🔧	📄
200	19	280	95	19,50	5	013700620
300	23	300	105	21,30	5	013700630
500	27	320	118	23,20	5	013700650
800	33	350	130	24,80	4	013700680
1000	36	360	135	31,50	4	013700700
1500	42	365	145	36,50	2	013700750

1370F

riveting hammers, wooden shaft



	A mm	L mm	L1 mm	€	🔧	📄
24	260	77	280	19,60	2	013700424
26	260	80	310	20,80	2	013700426
28	280	86	400	21,90	2	013700428
30	280	92	450	23,10	2	013700430
32	300	100	550	24,30	2	013700432
36	300	104	720	31,50	2	013700436
40	330	110	1065	35,00	2	013700440
42	330	116	1080	36,50	2	013700442
50	380	138	1760	38,50	2	013700450
60	380	160	2585	47,50	2	013700460

1370F/MR...

spare shafts for item 1370F

	€	🔧	📄
1370F/MR 24 1370F/24-26	4,95	2	013700474
1370F/MR 28 1370F/28-30	5,40	2	013700478
1370F/MR 32 1370F/32-36	6,25	2	013700482
1370F/MR 40 1370F/40-42	7,80	2	013700490
1370F/MR 50 1370F/50	8,85	2	013700495
1370F/MR 60 1370F/60	10,70	2	013700496

1370FT

riveting hammers, fibre shafts



A mm	L mm	L1 mm	€	🔧	📄	
28	280	86	530	32,00	1	013700528
30	280	92	625	33,50	1	013700530
32	300	100	750	35,00	1	013700532
36	300	104	930	41,50	1	013700536
40	330	110	1150	44,00	1	013700540
42	330	116	1250	45,00	1	013700542
50	380	138	2100	50,50	1	013700550
60	380	160	2750	54,50	1	013700560

1374F

carpenter's hammers, wooden shaft



A mm	L mm	L1 mm	€	🔧	📄	
16	250	80	180	15,60	2	013740416
20	270	86	250	17,40	2	013740420
22	290	92	335	18,00	2	013740422
26	290	103	425	20,30	2	013740426
28	310	108	510	21,30	2	013740428
30	310	117	580	22,50	2	013740430

1374F/MR...

spare shafts for item 1374F

	€	🔧	📄
1374F/MR 16 1374F/16	4,55	2	013740456
1374F/MR 20 1374F/20	4,65	2	013740460
1374F/MR 22 1374F/22-26	4,75	2	013740462
1374F/MR 28 1374F/28	5,40	2	013740468
1374F/MR 30 1374F/30	5,80	2	013740470

1375

claw hammer, wooden shaft



g	L1 mm	Ø mm	L mm	€	Hand	Code
300	95	25	300	18,00	3	013750000

1375/MR

spare shafts for item 1375



Code	€	Hand	Code
1375/MR	8,20	2	013750003

1375A

claw hammers, plastic shafts



oz	g	L mm	L1 mm	€	Hand	Code
16	450	330	130	26,00	3	013750016
20	570	330	130	27,50	3	013750020

1375B

claw hammers, steel shafts



oz	g	L mm	L1 mm	€	Hand	Code
16	450	330	130	23,90	3	013750026
20	570	330	130	24,40	3	013750030

1376X

claw hammers with square peins, magnets and nail holders wooden shaft



g	A mm	L1 mm	L mm	€	Hand	Code
250	20	125	450	17,10	3	013760125
300	25	130	450	18,20	3	013760130
400	27	132	450	20,00	3	013760140

1376X/MR

spare shaft for item 1376X



Code	€	Hand	Code
1376X/MR	9,65	2	013760161

1376XT

claw hammers with square peins, magnets and nail holders plastic shaft



g	A mm	L1 mm	L mm	€	Hand	Code
250	20	125	500	20,70	3	013760525
300	25	130	500	21,90	3	013760530
400	27	132	500	23,20	3	013760540

1376XT/MR

spare shaft for item 1376XT



Code	€	Hand	Code
1376MR/XT	11,10	2	013760585

1377

ball pein hammers, round heads, for coppersmiths and tinsmiths, wooden shafts



HICKORY

g	L mm	L1 mm	€	Hand	Code
340	330	95	26,00	2	013770134
450	350	102	27,50	2	013770145
570	350	110	31,50	2	013770157
680	360	116	33,00	2	013770168
900	380	120	34,50	2	013770190

1377/MR...

spare shafts for item 1377



Code	€	Hand	Code
1377MR 340 1377/340	5,70	2	013770234
1377MR 450 1377/450	6,55	2	013770245
1377MR 570 1377/570	7,30	2	013770257
1377MR 680 1377/680	7,40	2	013770268
1377MR 900 1377/900	9,20	2	013770290

1377T

ball pein hammers, round hands, for coppersmiths and tinsmiths, fibre shafts



g	L mm	L1 mm	€	Hand	Code
340	330	95	24,20	2	013770534
450	350	102	29,00	2	013770545
570	350	110	32,00	2	013770557
680	360	116	34,50	2	013770568
900	380	120	39,00	2	013770590

1378

joiner's hammers, round heads and peins, wooden shaft



HICKORY

g	L mm	L1 mm	Ø mm	€	Hand	Code
340	330	100	27	23,70	2	013780134
570	350	115	32	31,50	2	013780157

1378/MR...

spare shafts for item 1378



Code	€	Hand	Code
1378MR 340 1378/340	5,40	2	013780234
1378MR 570 1378/570	7,50	2	013780257

1379F

electrician's hammers, wooden shafts



HICKORY

NF E 71.011

A mm	L mm	L1 mm	€	Hand	Code
16	250	126	15,50	2	013790416
18	250	135	16,90	2	013790418
20	260	142	18,00	2	013790420

1379F/MR...

spare shafts for item 1379F



1379F/MR 16 1379F/16-18	€ 4,85	2	013790426
1379F/MR 20 1379F/20	€ 5,40	2	013790430

1380

lump hammers, wooden shafts



HICKORY

UNI 7777 DIN 6475

g	A mm	L mm	L1 mm	€		
800	38	260	90	20,00	2	013800208
1000	40	260	95	21,50	2	013800210
1250	43	260	100	22,70	2	013800212
1500	45	280	110	26,00	2	013800215
2000	50	300	120	34,00	2	013800220

1380/MR...

spare shafts for item 1380



1380MR 800 1380/800-1000-1250	€ 6,35	2	013800238
1380MR 1500 1380/1500	€ 6,80	2	013800245
1380MR 2000 1380/2000	€ 7,70	2	013800250

1380S

mason club hammers with security collars
wooden shafts



g	A mm	L mm	L1 mm	€		
800	36	260	90	21,90	2	013800400
1000	39	260	95	24,20	2	013800405
1250	43	260	100	26,00	2	013800410
1500	45	260	110	29,00	2	013800415

1380S/MR...

spare shafts for item 1380S



1380S/MR 800 1380S/800-1000-1250	€ 6,55	2	013800417
1380S/MR 1500 1380S/1500	€ 7,20	2	013800419

1380T

Mason club hammers,
fibre shafts



g	A mm	L mm	L1 mm	€		
800	35	260	85	30,50	2	013800308
1000	40	260	100	31,00	2	013800310
1250	42	260	110	33,00	2	013800312
1500	45	260	120	35,50	2	013800315
2000	49	295	120	43,00	1	013800320

1381

sledge hammers, Hickory shafts



HICKORY

g	A mm	L mm	L1 mm	€		
3000	55	800	142	81,50	1	013810030
4000	60	900	152	91,00	1	013810040
5000	70	900	162	103,50	1	013810050
8000	80	900	185	178,50	1	013810080

* = ash shaft

1381/MR...

spare shafts for item 1381



1381MR 3-4 1381/3000-4000	€ 40,50	2	013810730
1381MR 5 1381/5000	€ 42,50	2	013810750
1381MR 8 1381/8000	€ 42,50	2	013810780

1381T

sledge hammers,
fibre shafts



g	A mm	L mm	L1 mm	€		
3000	55	900	142	88,50	1	013810330
4000	60	900	152	97,00	1	013810340
5000	70	900	162	110,50	1	013810350
8000	82	920	180	204,50	1	013810380

1385

copper head hammers, wooden shafts



g	A mm	L mm	L1 mm	€		
400	26	260	75	31,00	2	013850404
600	32	270	80	45,00	2	013850406
800	34	280	90	59,00	2	013850408
1000	37	280	100	73,50	2	013850410
1500	43	280	110	107,50	2	013850415
2000	48	300	120	145,00	1	013850420

1385/MR

spare shafts for item 1385



1385MR 400 1385 400	€ 8,85	2	013850464
1385MR 600 1385 600	€ 9,10	2	013850466
1385MR 800 1385 800	€ 9,40	2	013850468
1385MR 1000 1385 1000	€ 10,10	2	013850470
1385MR 1500 1385 1500	€ 11,20	1	013850475
1385MR 2000 1385 2000	€ 11,50	1	013850480

1390

soft face hammers, wooden shafts



UNI 7784

Ø mm	L mm	L1 mm	€		
22	260	70	17,60	5	013900022
28	280	85	21,80	5	013900028
35	310	95	29,50	5	013900035
45	320	107	47,00	4	013900045
60	380	128	80,00	2	013900060

1390/MR...

spare shafts for item 1390



1390MR 22 1390/22	€ 4,35	2	013900222
1390MR 28 1390/28	€ 4,95	2	013900228
1390MR 35 1390/35	€ 5,90	2	013900235
1390MR 45 1390/45	€ 7,20	2	013900245
1390MR 60 1390/60	€ 8,85	2	013900260

1390R

spare faces for item 1390



Ø mm	€	Hand	Icon
22	2,78	4	013900122
28	4,30	4	013900128
35	5,70	4	013900135
45	9,65	4	013900145
60	16,80	4	013900160

1390N

nylon face hammers, wooden shafts

Medium-hard faces: 75 Shore
Oil and wear resistant
Particularly suitable for working metal



UNI 7784

Ø mm	L mm	L1 mm	€	Hand	Icon
22	260	70	17,60	3	013900522
28	280	85	21,80	3	013900528
35	310	95	29,50	3	013900535
45	320	107	47,00	2	013900545
60	380	128	80,00	2	013900560

1390NR

spare nylon faces for item 1390N



Ø mm	€	Hand	Icon
22	2,78	4	013900622
28	4,30	4	013900628
35	5,70	4	013900635
45	9,65	4	013900645
60	16,80	4	013900660

1391

dead-blow hammers, entirely covered with rubber



Ø mm	L mm	L1 mm	€	Hand	Icon
35	280	90	27,00	2	013910135
50	320	105	35,50	2	013910150
55	355	110	42,00	2	013910155
65	380	130	57,00	2	013910165

1391A

dead-blow hammers for tile workers, entirely covered with rubber



g	Ø mm	L mm	L1 mm	€	Hand	Icon
500	45	290	100	25,50	2	013910205
1000	60	300	120	34,00	2	013910210

1392

dead-blow hammers, with interchangeable plastic faces, steel shafts



Ø mm	L mm	L1 mm	€	Hand	Icon
30	300	105	45,50	2	013920030
35	305	115	48,50	2	013920035
40	310	125	56,00	2	013920040
50	325	135	66,00	2	013920050
60	385	155	102,00	2	013920060

1392R

spare faces for item 1392



Ø mm	€	Hand	Icon
30	6,10	4	013920230
35	8,95	4	013920235
40	13,60	4	013920240
50	18,10	4	013920250
60	27,00	4	013920260

1393

hard rubber head hammers



Ø mm	L mm	L1 mm	€	Hand	Icon
50	315	90	12,00	3	013930050
60	340	110	13,60	3	013930060
70	370	130	16,30	2	013930070

VEHICLE REPAIR

Our vehicle repair tools, which are used by the most demanding professionals, are developed and manufactured to meet the world's highest standards, and regularly tested under the most stressful operating conditions.

For over 50 years, we have been proudly working hand in hand with the greatest champions, who help us improve our products non-stop and provide testimony to the highest quality standard.

The vehicle repair tools are found in these sections:

Diagnostics	items 1438 to 1499 items 1758VT to 1760TMC
Engine	items 955 to 989A items 1438 to 1499
Oil and filters	items 1438 to 1499 items 1877 to 1885
Electric system	items 1438 to 1499
Transmission	items 1438 to 1499
Suspension	items 1549 to 1569CP
Brakes	items 1438 to 1499
Wheels	items 955 to 989A
Body work	items 1302 to 1369 items 1763 to 1767A
Other equipment	items 1878 to 3067



1410/M

spring pulling hook wrench



Ø mm	€	🔧	📦
3,5	17,10	2	014100051

1428

pullers for damaged nuts with square drive



mm	□	L mm	Ø mm	€	🔧	📦
8	3/8	36	17	17,10	2	014280008
10	3/8	36	17	17,10	2	014280010
11	3/8	36	17	17,10	2	014280011
12	3/8	36	19	17,10	2	014280012
13	3/8	36	19	17,10	2	014280013
14	3/8	36	19	17,10	2	014280014
15	1/2	38	21	18,20	2	014280015
16	1/2	38	21	18,20	2	014280016
17	1/2	38	21	18,20	2	014280017
18	1/2	38	26	18,20	2	014280018
19	1/2	38	26	18,20	2	014280019
20	1/2	38	26	20,20	2	014280020
21	1/2	38	26	20,20	2	014280021
22	1/2	38	26	21,90	2	014280022
24	1/2	38	26	21,90	2	014280024
27	1/2	38	26	23,00	2	014280027

1428L

socket pullers, long series, for damaged right-hand nuts, with square drive



mm	€	🔧	📦
17	44,00	1	014280217
19	45,00	1	014280219
21	48,00	1	014280221



1428L/B3	€	🔧	📦
17-19-21 mm	137,00	1	014280303



1428/SB11	€	🔧	📦
8-10-11-12-13-14	207,00	1	014280111
15-16-17-18-19 mm			
1428/SB5	€	🔧	📦
20-21-22-24-27 mm	115,00	1	014280115

1429

pullers for damaged screws and stud bolts with square drive



mm	□	L mm	€	🔧	📦
2	3/8	60	11,30	3	014290002
3	3/8	60	11,30	3	014290003
4	3/8	60	11,30	3	014290004
5	3/8	60	12,00	2	014290005
6	3/8	60	12,00	2	014290006
8	1/2	70	13,00	2	014290008
10	1/2	70	13,30	2	014290010



1429/SB7	€	🔧	📦
2-3-4-5-6-8-10 mm	93,50	1	014290107

1430/...

tapered extractors for broken screws and studs made from hardened and tempered steel

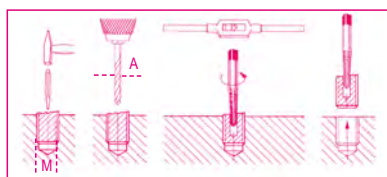

	M	A mm	€	🔧	📦
1430/1	3÷6	2,5	3,20	10	014300006
1430/2	6÷8	3,0	3,55	10	014300008
1430/3	8÷11	4,5	4,30	10	014300011
1430/4	11÷14	6,0	5,60	10	014300014
1430/5	14÷18	8,0	6,35	10	014300018
1430/6	18÷24	11,0	12,40	5	014300024
1430/7	24÷33	14,0	18,60	5	014300033
1430/8	33÷50	21,0	23,70	5	014300050



1430/S5	€	🔧	📦
1430/1-1430/2-1430/3	23,90	1	014300105
1430/4-1430/5			
1430/S6	€	🔧	📦
1430/1-1430/2-1430/3	34,50	1	014300106
1430/4-1430/5-1430/6			
1430/S8	€	🔧	📦
1430/1-1430/2-1430/3	76,50	1	014300108
1430/4-1430/5-1430/6			
1430/7-1430/8			

1431/...

tapered extractors for broken screws and studs

For removing screws and studs that cannot be held firmly, percussion mechanism

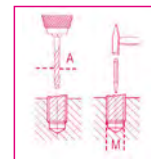

	M	A	L	□	€	🔧	📦
1431/3	3÷6	2,5	59	5	5,70	10	014310051
1431/5	6÷8	5,0	68	5	5,70	10	014310052
1431/6	8÷11	6,0	72	6	6,80	10	014310053
1431/8	11÷14	8,0	77	8	7,40	10	014310054
1431/9	14÷18	9,0	82	9	7,90	10	014310055

1431/C5

tapered extractors for broken screws and studs

Percussion mechanism

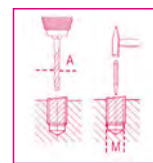

	M	A	€	🔧	📦
1431/C5	6÷18	3÷9	34,00	1	014310005

1433

roller stud extractors

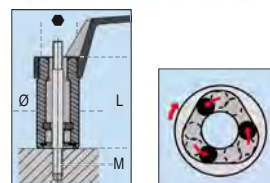

M mm	Ø mm	L mm	□	€	🔧	📦
5	21	60	19 3/8	12,70	2	014330005
6	24	60	21 1/2	12,70	2	014330006
7	24	60	21 1/2	12,70	2	014330007
8	24	60	21 1/2	12,70	2	014330008
9	28	70	21 1/2	15,00	2	014330009
10	28	70	21 1/2	15,00	2	014330010
10,5	28	70	21 1/2	15,00	2	014330021
11	28	70	21 1/2	15,00	2	014330011
12	28	70	21 1/2	15,00	2	014330012
14	36	72	24	23,70	2	014330014
16	36	72	24	23,70	2	014330016

1433/C11

roller stud extractors
with 1/2" female square drives

3/8"
1/2"



1433/C11 € 246,00 1 014330311
M5 - M6 - M7 - M8 - M9 - M10 - M10,5
M11 - M12 - M14 - M16

340x135x56 mm - 3,0 kg

1435

eccentric stud extractor

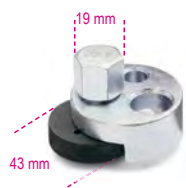

∅ mm € 92,50 1 014350001
4÷20

1435R

spare wheel for item 1435



1435R € 28,50 1 014350010

1435/1

eccentric stud extractor

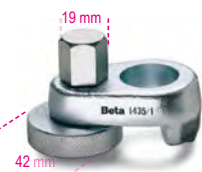

∅ mm € 114,50 1 014350002
19÷26

1435/1R

spare wheel for item 1435/1

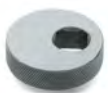

1435/1R € 29,50 1 014350011

1437/C12

assortment of 12 tools for removing air bags



1437/C12 € 92,00 1 014370001

260x160x55 mm - 1,0 kg

1438

universal clutch aligner complete
with 3 expansion mandrels



1438 € 49,50 1 014380001

1438R

spare expansion mandrels
for item 1438



∅ mm € 3,40 5 014380101
14÷18 3,40 5 014380102
18÷21 3,40 5 014380103
22÷25 3,40 5 014380103

1438DCT

tool for removing and installing 6-speed DCTs

for use on Volvo, Ford, Chrysler and Dodge vehicles

3/8"



1438DCT € 142,00 1 014380300

1438EVO

universal clutch aligning kit

Component parts made entirely from metal



1438EVO € 221,00 1 014380011

290x200x60 mm - 2 kg

1438DSG

lever for locking/unlocking DSG dual-clutch
gearbox
from VAG group



1438DSG € 30,00 1 014380200

1438K/DSG-2

tool set for aligning 6- and 7-speed DSG
clutches

for use with 6-speed DSG and manual-shift,
7-speed DSG (series 1 and 2) and S-tronic gearboxes.



1438K/DSG-2 € 556,00 1 014380260

350x370x117 mm - 10 kg

1438K/PWR

removal/installation tool set
for Powershift dual clutch transmission



€ 380,00 1 014380270

440x400x85 mm - 10 kg

1438DCT/S

tool set for aligning Ford dry dual clutches

for clutch alignment
after carrying out jobs like clutch oil seal replacement



€ 289,00 1 014380305

440x400x85 mm - 8 kg

1439/K7

angular screwdriver (90°), long series,
with blades, in case



Case contents:
- Angular screwdriver
- 1 slotted screw head
- 1 1/4" bit head
- Special blade head
- 7 special blades

€ 183,50 1 014390101

500x120x60 mm 825 g

1440/...

piston ring compressors



	Ø mm	L mm	€	1	014400000
1440/0	40÷75	50	27,50	1	014400000
1440/1	57÷125	80	36,00	1	014400010
1440/1A	57÷125	100	41,00	1	014400011
1440/2	90÷175	80	44,00	1	014400020
1440/2A	90÷175	100	45,50	1	014400021
1440/3	90÷175	165	66,50	1	014400030

1445/1 - 1445/2

piston ring expanders



	Ø mm	€	1	014450001
1445/1	50÷100	37,50	1	014450001
1445/2	90÷150	48,00	1	014450002

1450GC

valve spring compressor
with straight and offset jaws



€ 108,00 1 014500005

1452K

valve spring compressor,
with three flanges



€ 143,00 1 014520100

1452PN/K

pneumatic tool for engine valve springs

Thrust pressure: 1400 N



Ø mm	L mm	L1 mm	€	1	014520110
16-19-23	230	185	305,00	1	014520110
25-30-42					

1454P

scraper for removing
packing and sealant residues
particularly recommended for cleaning
heads and flat surfaces to match



L mm	L1 mm	± mm	€	1	014540010
210	32	3,3	40,00	1	014540010

1455SVP

pneumatic valve grinder

• Pressure: 6 bars



€ 348,00 1 014550001

1455SVP/R...

spare parts for item 1455SVP



	€	5	014550501
1455SVP/R1	6,25	5	014550501
1455SVP/R2	6,25	5	014550502
1455SVP/R3	6,25	5	014550503

1457/B4

tool set for releasing
Rilsan hose fittings

Sizes included in set:

- 6x8
- 10x12
- 15x16
- 18x1/2



1457/B4 € 46,50 1 014570024

1458

external butt-ended circlip pliers



DIN 5417

Ø mm 30÷100 € 68,50 2 014580001

1460F

valve seat removing tool



1460F € 58,50 1 014600010

1461/C3B

timing devices for
Fiat/Alfa/Lancia petrol engines

Engines: 1.2-1.4 16V



1461/C3B € 319,00 1 014610032
≡ 280x245x75 mm 1,5 kg

1461/C5G

timing devices for Fiat/Alfa/Lancia/Opel/
Suzuki/Ford
diesel engines

Engines: 1.3 Multijet



1461/C5G € 283,00 1 014610053
≡ 280x245x75 mm 2,6 kg

1461/C6B

timing devices for
Peugeot/Citroën petrol engines

Engines: 1.0-1.1-1.4-1.6-1.6 16v-1.6Gti-1.6 18V-1.8-1.8 16v-1.9-
2.0-2.0 16v-2.0T-2.0 Hpi-2.2 16v



1461/C6B € 427,00 1 014610063
≡ 310x290x120 mm 3,5 kg

1461/C6G

timing devices for
Peugeot/Citroën diesel engines

Engines: 1.4-1.6-2.0D,1.4-1.6TDCI, 1.4-1.6-2.0-2.2Hdi,
1.5-1.9-2.5D



1461/C6G € 563,00 1 014610064
≡ 385x290x100 mm 3,8 kg

1461/C7B

timing devices for
Renault/Nissan petrol engines

Engines: 1.4-1.6-1.8-2.0 16V



1461/C7B € 323,00 1 014610072
≡ 280x245x75 mm 3,2 kg

1461/C8B

timing devices for Ford petrol engines

Engines: 1.25-1.4-1.6-1.6 SCTi-1.6 Ti-VCT-1.6 16V



1461/C8B € 224,00 1 014610083
≡ 240x210x50 mm 1,8 kg

1461/C8G

timing devices for Ford/Mazda diesel engines

Engines: 1.4-1.6-1.8-2.0-2.2 TDCi, 1.6D 8/16V, 1.8D,
1.8D Turbo, 1.8 TCi, 1.8 TDDi, 2.5D, 2.5D Turbo



1461/C8G € 386,00 1 014610084
≡ 280x245x75 mm 2,2 kg

1461/C9B

timing devices for Opel petrol engines

Engines: 1.0 12V, 1.0-1.2-1.4 16V



1461/C9B € 178,50 1 014610092

335x145x60 mm 2 kg

1461/C10G

timing devices for Volkswagen/Audi/Seat and Skoda engines

Engines: 1.2-1.6-2.0 TDI CR (common rail)



1461/C10G € 559,00 1 014610103

310x290x120 mm 2,8 kg

1461/C11A

timing devices for Renault engines

Engines: 2.0 dCi



1461/C11A € 190,00 1 014610111

420x280x60 mm 1,2 kg

1461/C11G

timing devices for Renault engines

Engines: 1.5-1.9-2.2-2.5 DCI



1461/C11G € 463,00 1 014610113

310x290x120 mm 3,8 kg

1461/C12A

timing devices for Fiat engines

Engines: 1.9-2.2 JTS and 1.9 JTD Euro 4



1461/C12A € 337,00 1 014610123

280x245x75 mm 1,8 kg

1461/C12G

timing devices for Fiat/Alfa/Lancia diesel engines

Engines: 1.9 JTD, 1.6-1.9-2.0 Multijet



1461/C12G € 288,00 1 014610124

280x245x75 mm 2 kg

1461/C13A

timing devices for Fiat 0.9 Twinair turbo engines



1461/C13A € 152,00 1 014610133

240x210x50 mm 1,7 kg

1461/C13B

timing devices for Fiat 1.4 Multiair engines



1461/C13B € 233,00 1 014610134

240x210x50 mm 2,8 kg

1461/C17B

timing devices for Volkswagen/Audi/Seat and Skoda petrol engines

Engines: 1.2 TSI



1461/C17B € 129,50 1 014610171



1461/C18B

timing devices for
Volkswagen/Audi/Seat and Skoda petrol
engines

Engines: 1.6-1.8-1.8T, 1.4-1.6-1.8-2.0 16V,
1.4-1.6-2.0 FSI



1461/C18B € 443,00 1 014610182
310x290x120 mm 2,5 kg

1461/C20G

timing devices for
Fiat Iveco/Peugeot/Citroën/Ford diesel
engines

Engines: 2.2-2.3-3.0 Multijet



1461/C20G € 770,00 1 014610221
385x290x100 mm 5,5 kg

1461/C21G

timing devices for Renault diesel engines

Engines: 1.6 dCi



1461/C21G € 433,00 1 014610222
310x290x120 mm 3 kg

1461/C22B

timing devices for Peugeot/Citroën petrol
engines

Engines: 1.0-1.2 VTi



1461/C22B € 397,00 1 014610223
280x245x75 mm 2 kg

1461/C23B

timing devices for Opel petrol engines

Engines: 1.0 - 1.2 - 1.4 ecoflex



1461/C23B € 553,00 1 014610224
280x245x75 mm 2,5 kg

1461/C24B

timing devices for Mini-Peugeot/Citroën petrol
engines

Engines: 1.4 - 1.6 (N12-N14)



1461/C24B € 645,00 1 014610225
280x245x75 mm 2,8 kg

1461/C25G

timing devices for Mini diesel engines

Engines: 1.6 diesel (W16D)



1461/C25G € 144,00 1 014610226
270x120x45 mm 1 kg

1461/C27G

timing devices for Bmw diesel engines

Engines: 1.6-2.0D (N47-N47S)



1461/C27G € 259,00 1 014610228
280x245x75 mm 2 kg

1461/C28B

timing devices for
Volkswagen, Seat and Skoda petrol engines

engines: 1.0 - 1.0 Bluemotion Tech
1.0 Ecofuel/Ecomotive - 1.0 Green Tech



1461/C28B € 461,00 1 014610229
280x245x75 mm 1,7 kg

 **Beta**
Quality Tools

1461/C29B

timing devices for
Ford petrol engines
engines: 1.0 EcoBoost



1461/C29B € 663,00 1 014610209
280x245x75 mm - 2,6 kg

1461/C30G

timing devices for
Volkswagen/Audi/Seat and Skoda diesel
engines
engines: 1.6-2.0 CR TDI
for engines built as from 2012



1461/C30G € 600,00 1 014610231
280x245x75 mm - 2 kg

1461/C31B

timing devices for Volkswagen/Audi/Seat and
Skoda petrol engines

Engines: 1.0-1.2-1.4 TSI/TFSI



1461/C31B € 484,00 1 014610232
270x230x80 mm - 2,1 kg

1461/C32G

timing devices for Opel diesel engines

Engines: 1.6 CDTi (B16)



1461/C32G € 295,00 1 014610233
270x230x80 mm - 1,3 kg

1461/C33B

timing devices for Opel petrol engines

Engines: 1.0 - 1.0 Turbo SIDI Ecoflex



1461/C33B € 96,00 1 014610234

1462CF/C6

set of 6 single-ended bi-hex wrenches
for fuel injector connectors

sizes:
12-14-16-17-18-19 mm



1462CF/C6 € 90,00 1 014620006
260x145x60 mm - 1,2 kg

1462CF

single-ended bi-hex wrenches
for fuel injector connectors



mm	€	1	014620012
12	14,30	1	014620012
14	14,50	1	014620014
16	14,80	1	014620016
17	15,00	1	014620017
19	15,80	1	014620019
18	15,40	1	014620018

1462CF-SN/C6

set of 6 single-ended, articulated hexagon
wrenches for fuel injector connectors

sizes:
12-14-16-17-18-19



1462CF-SN/C6 € 130,50 1 014620026
275x182x64 mm

1462CF-SN

single-ended, articulated hexagon wrenches
for fuel injector connectors



mm	€	1	014620032
12	22,70	1	014620032
14	23,10	1	014620034
16	24,10	1	014620036
17	24,80	1	014620037
18	25,50	1	014620038
19	26,50	1	014620039

1462/KD

tool assortment for removing Denso injectors,
complete with hammer



1462/KD € 790,00 1 014620060
335x210x80 mm - 4,8 kg

1462/KI

assortment of common rail diesel injector pullers

Allows DELPHI-BOSCH-SIEMENS-DENSO injectors to be removed



1462/KI € 2.355,00 1 014620235
530x470x140 mm - 2,0 kg

1462/KMRC

tool assortment for removing injectors from Mercedes 2.1L, 2.2L, 3.0 V6 and Chrysler engines

For Bosch (2.1 and 2.2L) and Delphi (3.0) injectors Injectors can be removed without removing engine. Particularly suitable for following car models: Mercedes Vito, Vario, CLK, Sprinter, Viano, M, GL, C, GLK, E, CLS, S, R, G Classes Chrysler 300 C



1462/KMRC € 670,00 1 014620070
310x300x118 mm - 3,5 kg

1462/KU

universal tool assortment for removing diesel common rail injectors

Complete with pliers and hammer



1462/KU € 704,00 1 014620100
390x290x100 mm - 4,5 kg

1462/MB

hammer face kit for removing injectors

Kit contents:

- 1 4 kg hammer face with 400 mm rod
- 1 articulated adapter, male M10x1.5, female M22x1.5 mm
- 1 adapter, male M22x1.5, female M13x1.4 mm
- 1 adapter, male M14x1.5, female M27x1 mm
- 1 adapter, male M14x1.5, male M25x1 mm
- 1 adapter, male M14x1.5, male M27x1 mm
- 1 adapter, male M14x1.5, female M14x1.5 mm
- 1 adapter, male M14x1.5, male M20x1 mm
- 1 adapter, male M14x1.5, male M17x1 mm



1462/MB € 283,00 1 014620110
500x250x80 mm - 7,2 kg

1462AD/BSC

adapter for removing Bosch common rail injectors

For use with items Beta 960KI and Beta 1462/KU



1462AD/BSC € 204,50 1 014620435

1462AD/SMN

adapter kit for removing Siemens and Denso injectors

For use with item Beta 960KI/1462KI



1462AD/SMN € 306,00 1 014620436

1462/EI

universal vibration tool for injector removal

- Helps to fully remove jammed injectors from their housings, without damaging cylinder heads and without breaking injectors.
- Can be used with any injector removal set, with or without hammer face.
- Tool acts directly on removal tie rod, which is coupled with injector, through vibrations and pulses.
- Control valve allows vibration intensity to be adjusted to type of work to be carried out.



1462/EI € 623,00 1 014620240

1462PIM

injector maintenance plates, pair vice locking sections: Ø 11-12-13-14-16-19-20 mm



1462PIM € 98,50 1 014620502

1463/KIT

valve timing system pulley locking kit



1463/KIT € 380,00 1 014630001
280x140x75 mm - 1,2 kg

1464T

digital pressure and compression tester

SPECIFICATIONS

- 5" touch screen display
- rechargeable polymer lithium battery
- complete with 80 bar sensor (for low pressure) and USB cable



A major advantage of item 1464T is that you can purchase several different additional kits to perform other tests as well, including the high pressure circuit test in common rail engines:

- **1464ADB** for testing AdBlue® system pressure
- **1464VD** for measuring and storing maximum vacuum value
- **1464FAP** for testing diesel particulate filter (DPF) pressure
- **1464APB** for testing high pressure system in FSI petrol engines
- **1464PF** for testing pressure in braking system
- **1464PT** for testing turbo pressure
- **1464TDI** for testing pump pressure in TDI engines
- **1464FG** Set of dummy regulators for testing diesel common rail system
- **1464CBD** Comprehensive adapter set for testing compression in petrol and diesel engines
- **1464IC** Set of dummy injectors and dummy glow plugs to check compression in diesel engines
- **960AD/TP2** for petrol and diesel engine compression, engine oil pressure, common rail low pressure, petrol injection pressure

1464T € 829,00 1 014640050

1464T/SP80

pressure sensor, 80 bars, for items 1464T and 960TP



1464T/SP80 € 284,00 1 014640053

960AD/TP2

set of adaptors for item 960TP in plastic case



960AD/TP2 € 491,00 1 009600051
430x310x50 mm - 3,2 kg

Beta

1464CBD

comprehensive adapter set for testing compression in petrol and diesel engines, with tester 1464T

Makes it possible to connect to engine to test petrol and diesel compression with tester 1464T

Contents:

- 8 dummy spark plugs with non-return valves
- 44 dummy glow plugs with non-return valves
- 1 adjustable universal dummy injector for cars, trucks, marine engines and agricultural machines
- 1 90° adapter, pressure release valve and connecting hose
- space accommodating tester 1464T in case



1464CBD € 676,00 1 014640300
510x410x140 mm - 5,5 kg

1464IC

complete set of dummy injectors and dummy glow plugs for item 1464T

Makes it possible to connect to the engine to check compression in diesel engines with digital tester 1464T.

Contents:

- 22 dummy glow plugs
- 5 dummy injectors
- 1 universal dummy injector kit for cars, trucks, marine engines and agricultural machines



1464IC € 556,00 1 014640350
559x312x50 mm - 4,5 kg

1464IC/RK

universal dummy injector kit for cars, trucks, marine engines and agricultural machines

supplied with item 1464IC



1464IC/RK € 179,50 1 014640377
200x110x30 mm - 885 g

1464AP

set for testing high pressure system in common rail diesel engines, with item 1464T

Complete with:

- high pressure pipe set
- fittings
- 2,000 bar sensor



1464AP € 749,00 1 014640450
430x310x50 mm - 1,8 kg

1464AP T

high-pressure pipe for items 1464AP and 960TAP



1464AP T12X12 € 58,50 1 014640453
1464AP T12X14 € 58,50 1 014640454
1464AP T14X12-M1,0 € 58,50 1 014640455

1464AP T16X12



1464AP T16X12 € 69,00 1 014640456

1464FG

set of dummy regulators
for testing diesel common rail system
(for use with Beta 1464T-1464AP)

Used with the tester and suitable adapters, it makes it possible to determine whether the problem is the high pressure pump or the regulator when there is no pressure in the high pressure circuit in common rail engines.
Recommended for Bosch, Delphi, Denso and Siemens pressure regulators



1464FG € 289,00 1 014640470
≡ 350x250x80 mm - 1,8 kg

1464FG/CP4

dummy regulator for Bosch CP4 pump,
not supplied with item 1464FG



1464FG/CP4 € 42,50 1 014640475

1464APB

set for testing high pressure
system in FSI petrol engines,
for use with item 1464T

comes with 200 bar sensor
and connectors



1464APB € 368,00 1 014640500
≡ 240x210x50 mm - 0,5 kg

1464PB

set of 9 connectors for testing
fuel low pressure
(for use with item 1464T)

Quick connectors to tester 1464T
allow fuel low pressure in diesel and petrol engines to be
quickly checked



1464PB € 511,00 1 014640700
≡ 530x440x120 mm - 3,8 kg

1464ADB

set for testing AdBlue® system pressure
for item 1464T

Supplied with adaptors for use with 80-bar standard sensor
supplied with item
1464T



1464ADB € 85,00 1 014640620
≡ 240x210x50 mm - 0,5 kg

1464FAP

set for testing diesel particulate filter (DPF)
pressure
for item 1464T

Supplied with:
- 500 mbar sensor
- 8 mm adaptor with quick coupling and T fitting
- 3-m-long RJ45 cable



Technical data:
• Pressure test: 0÷500 mbar
• Resolution: 1 mbar

1464FAP € 182,50 1 014640610
≡ 240x210x50 mm - 0,5 kg

1464PT

set for testing
turbo pressure,
for use with item 1464T

comes with sensor
and connecting cable



1464PT € 161,00 1 014640550
≡ 240x210x50 mm - 380 g

1464TDI

set for testing
pump pressure
in TDI engines,
for use with item 1464T

comes with connector



1464TDI € 115,50 1 014640600
≡ 240x210x50 mm - 400 g

1464VD

vacuum testing set
for item 1464T

For measuring and storing maximum vacuum value
Supplied with:
- 800 mbar sensor
- 6 and 8 mm adaptors
- 3-m-long RJ45 cable

Technical data:
• Vacuum test: 0÷800 mbar
• Resolution: 1 mbar
• Maximum value storage



1464VD € 182,50 1 014640570
≡ 240x210x50 mm

1464PF

set for testing
pressure in braking
system,
for use with item 1464T
comes with adapters
and connectors



1464PF € 659,00 1 014640650
400x280x60 mm - 3 kg

1465

engine efficiency tester

Allows endothermic engine compression to be tested within just a few seconds, without requiring connection to engine, taking power from vehicle battery, through a dedicated software



CE



- Step 1: calculating engine rpm
- Step 2: testing battery voltage trend during each revolution
- Step 3: displaying absorbed power and compression calculated through starter operation for each piston
- Step 4: testing battery charge and efficiency

Technical data:

- Operating voltage: 12V DC (vehicle battery)
- Dimensions: 140x75x30 mm
- Clamp cable length: 1300 mm
- Weight: 215 g

1465 € 1.106,00 1 014650010

1466/C5

kit of 5 brake
bleeding wrenches

- kit contents:
- 5 wrenches sizes 7-8-9-10-11 mm
 - 1 drain hose with check valve



1466/C5 € 121,50 1 014660100
260x170x50 mm - 600 g

1466L 11

brake bleeding wrench, 11 mm,
long version



	Ø	L	€		
	mm	mm			
1466L 11	11	60	30,00	1	014660211

1466TLF

brake oil recovery tank
capacity: 1.5 l

Quick coupler for bleeding pipe Ø 5.5 mm



1466TLF € 44,00 1 014660201

1467

brake fluid extractor



Pressure: min 5 bar, max 11.5 bar

	l	€		
1467	1,5	324,00	1	014670001

1467/RK1

spare tube kit for item 1467



1467/RK1 € 24,40 1 014670501

1467/RK2

spare filler for item 1467



1467/RK2 € 93,00 1 014670502

1467LF/2

electric instrument for brake fluid replacement

with "pulsating effect" function



CE

"Pulsating effect"

- Automatically stops when tank is empty, thereby preventing air from being let in
 - Maximum tank volume: 20 l
 - Operating pressure: 0.4+3.5 bar
 - Power supply: 230V
- Supplied with:
- Brake oil recovery tank
 - 1 standard cap E20

1467LF/2 € 1.685,00 1 014670099

1467LF/RC

vessel with recovery tube for item 1467LF



1467LF RC € 102,50 1 014670125

1467TU

plug for brake fluid tanks

- can be adapted to 90% of available tanks
- for use with Beta's item 1467LF



1467TU	€ 63,50	1	014670090
--------	---------	---	-----------

1467T/C6

set of adapter plugs for brake fluid tanks, for use with BETA items 1467LF and 1467LF/2

Set contents:

- 1 plug for Toyota vehicles
- 1 plug for Ford, Hyundai, Mazda, Mitsubishi, Nissan, Subaru vehicles
- 1 plug for Honda vehicles
- 1 plug for Mazda and Suzuki vehicles
- 1 plug for Nissan vehicles
- 1 brake bleeding adapter plug for European vehicles



1467T/C6	€ 257,00	1	014670080
----------	----------	---	-----------

350x240x85 mm - 1,8 kg

1468N

valve depressors for disc removal

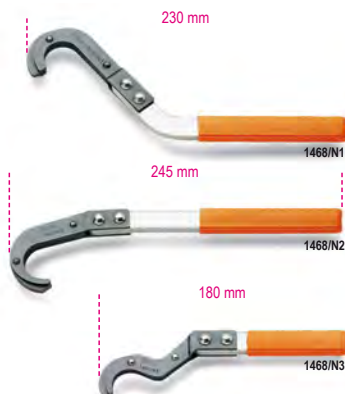

1468N/1	€ 23,30	1	014680011
1468N/2	€ 23,90	1	014680012
1468N/3	€ 24,40	1	014680013



1470

drum brake spring pliers



L mm	€		
210	37,50	1	014700001
330	48,00	1	014700002
540	145,00	1	014700010

1470FT

drum brake shoe spring clamp pliers

40° angled noses

Easy access to awkward spaces



L mm	€		
184	40,00	1	014700000

1470PF

tool for replacing cylinders in drum brakes

jaws remain open, for easy cylinder replacement

38°



A mm	€		
25÷140	73,00	1	014700200

1471

drum brake spring pliers



L mm	€		
330	74,00	1	014710001

1471A

handbrake wire pliers



A max mm	B mm	€		
45	5	89,50	2	014710010

1471GF

mouldable hooks for supporting brake calipers while replacing pads, pair



1471GF	Max kg 5	€ 13,60	1	014710310
--------	----------	---------	---	-----------

1471M/C22

pneumatic tool for pushing back and rotating right and left disc brake pistons with accessories



1471M/C22	€ 289,00	1	014710101
-----------	----------	---	-----------

350x310x85 mm - 3,5 kg

1471M/50

pneumatic tool for pushing back and rotating right and left disc brake pistons with accessories



∅ mm	Kg	Bar	€	
50	150	5÷8	159,00	1 014710069

1471M/P

worn pad and TRW-Mégane caliper adapters



1471M/P € 24,70 1 014710080

1471M/W50

VW Passat handbrake adapter (≥ 2005)

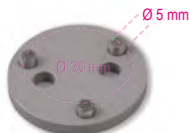

1471M/W50 € 8,65 1 014710079

1471PN/B1

Ford handbrake adapter



1471PN/B1 € 8,65 1 014710081

1471PN/B2

Daily handbrake adapter



1471PN/B2 € 12,10 1 014710082

1471PN/B3

BMW handbrake adapter



1471PN/B3 € 8,65 1 014710083

1471PN/B4

BMW handbrake adapter



1471PN/B4 € 8,65 1 014710084

1471PN/B5

Mini/ BMW handbrake adapter



1471PN/B5 € 7,50 1 014710085

1471CF

pentagon hand sockets for brake caliper nuts



mm 14 € 16,90 1 014710314
19 € 16,90 1 014710319

1471CM

pentagon socket driver for brake caliper screws



mm 10 € 16,90 1 014710360

1471CM/E11

hexagon socket driver, 11 mm, for Mercedes ML brake caliper screws (series 166)



mm 11 € 18,00 1 014710361
L 24 mm L1 75 mm

1471D2

tool for pushing back front disc brake pistons, with closed callipers

Two pairs of plates for working on 2 and 4 piston callipers



mm 10 € 75,00 1 014710301

250x170x60 mm 1,5 kg

1471T/C5

5 slogging wrenches for truck brake calipers

can be used with torque wrenches for tightening operations included sizes:
• female Torx wrenches E18, E20, E24
• ring wrenches M24, M26



1471T/C5 € 239,50 1 014710400

275x220x60 mm - 3,1 kg

1472

hose clamp pliers

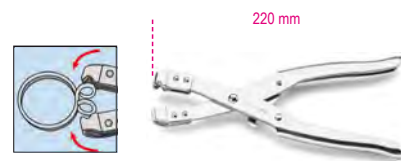

1472 € 42,50 1 014720001

1472AU

automatic hose clamp pliers



mm 18÷53 € 123,50 1 014720100

1472R/AU

spare tips for pliers 1472AU



1472AU/R € 47,00 1 014720101

1472AU/P

automatic hose ring pliers
with extension



∅ mm 18+54 L mm 630 € 108,50 1 014720105

1472AU/RP

spare cable for pliers 1472AU/P



1472AUP/R € 26,50 1 014720106

1472B/RNLT

double head socket, specially designed for
suction hose clamps installed on Renault
group engines

9 mm



1472B/RNLT € 17,10 1 014720250

1472FC

Clic® collar pliers with swivel heads



1472FC € 39,00 1 014720090

1472FC/GE

heavy-duty Clic® collar pliers

particularly suitable for
large-size clippers



L mm 230 € 68,50 1 014720093

1472FC/L

Clic® collar pliers with flexible extension



L 630 mm € 104,50 1 014720095

1472FCL/RP

spare cable for pliers 1472FC/L



1472FCL/RP € 46,00 1 014720096

1472FCA

collar removal pliers
with Visa® type rack



1472FCA € 59,00 1 014720041

1472H

Henn clamp removal tool



1472H L mm 100 € 23,10 1 014720000

1472MT/VW

pair of claws for disconnecting
suction manifolds in VAG cars

Can be used on turbocharged petrol engines 1.0 - 1.2 - 1.4



1472MT/VW € 11,10 1 014720500

1472TM

quick coupler pliers for multijet filters



1472TM € 27,50 1 014720200

1472VW

hose clamp pliers,
with swivel heads
For Volkswagen and Mercedes cars



1472VW € 44,50 1 014720051

1473

OETIKER® collar pliers



1473 275 € 121,50 1 014730001

1473A

slothholder pliers for OETIKER® collars



230 mm



1473A € 92,50 1 014730010

1473Q

OETIKER® collar pliers with drive

For use with:
• torque wrenches
• ratchets
• male drives



250 mm



1473Q € 85,00 1 014730005

1473P

clamp pliers for OETIKER® low-profile collars



210 mm



1473P € 34,50 1 014730020

1473FN

tool for tightening and cutting strap ties made of stainless steel

For use with Panduit® ties and the like



A mm 4,7÷9,5 € 63,50 1 014730501

1473T

steel collar cutting nippers

allows collars to be cut without risking damaging guards, sleeves etc.



A Max mm 14 L mm 220 € 57,50 1 014730582

1474/C4

kit of 4 tools for removing Volkswagen spark plug coils



1474/C4 € 96,00 1 014740100
290x190x50 mm - 1 kg

1474E/VW

expansion puller for ignition coils, Volkswagen group



1474E/VW € 26,50 1 014740120

1474E/VW2

ignition coil puller, for VAG group vehicles for use on engines 1.0 - 1.2 - 1.4 - 2.0



1474E/VW2 € 32,50 1 014740150

1474L

spark-plug pliers, curved long nose, 15°

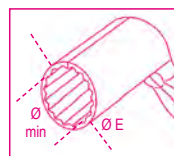

Ø min mm 14 Ø E mm 20 € 77,00 2 014740010

1474DL

spark-plug pliers, long nose, double layer PVC coated handles



1474DL € 37,00 1 014740015

1474G

curved long nose pliers for removing glow plug caps



1474G € 42,00 1 014740200



1475U

combination pliers,
bright chrome-plated,
double layer PVC coated gun handles



1475U € 39,00 1 014750010

1476

adjustable self-locking pliers
for exhaust pipe cutting



Ø min mm 19 Ø max mm 75 L mm 225 € 75,00 1 014760002

1476/RC

spare chain for item 1476



1476/RC € 36,50 1 014760012

1476A

pliers for exhaust pipe cutting



Ø min mm 30 Ø max mm 95 € 95,00 1 014760005

1476A/RC

spare chain for item 1476A



1476A/RC € 81,50 1 014760015

1476C/1

exhaust pipe expanders



1476C/1 € 36,00 1 014760101
Ø 30÷42 mm
L = 131 mm
L1 = 51 mm

1476GT

pliers for removing rubber supports
from exhaust pipes



L mm 280 A Max mm 58 $\frac{A}{L}$ mm 3 € 33,00 1 014760050

1476PSA

exhaust collar pliers
with pin, PSA group
Nose shape and automatic rack locking
make it possible to work
without pulling out pin



L mm 309 A Max mm 60 S mm 12,2 € 40,50 1 014760060

1476T

wrench for removing/installing turbines
on Volkswagen Audi diesel engines



Ø mm 12 € 36,50 1 014760200

1477/C10

bent wrench with 9 bits
for belt tightening nuts

1 bent wrench with bit drive
4 double bi-hex bits: 12x14 - 13x15 - 16x17 - 18x19 mm
5 bits for Torx(R) head screws: E10 - E12 - E14 - E16 - E18



1477/C10 € 156,00 1 014770310
530x110x55 mm

1477D

ring wrenches for belt tightening nuts



Ø mm 13 € 28,00 1 014770113
15 € 28,00 1 014770115
16 € 28,00 1 014770116
17 € 28,00 1 014770117
19 € 28,00 1 014770119

1477D/S5

set of 5 ring wrenches for belt tightening nuts



1477D/S5 € 140,00 1 014770200
13-15-16-17-19 mm
600x200x70 mm - 2,2 kg

1477K/7

kit with bent reversible ratcheting wrench
and bits



- 2 TORX T40-T45 bits
- 1 XZN 10 bit
- 1 hexagon bit, 8 mm
- 3 bi-hex bits, 10-12-13 mm

Ø mm 12 L mm 250 € 136,00 1 014770051

1478

pin removing pliers



1478 € 54,00 1 014780001

1478T

plastic pin removable pliers with swivel head and pressure clips

Head can be rotated 90°



1478T S mm € 42,50 1 014780101

1478/3P

plastic pin removal pliers with 3 release points

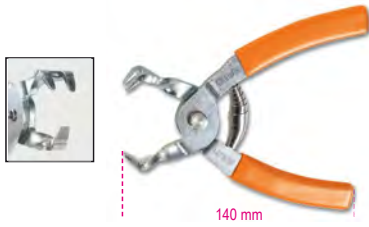

1478/3P € 60,00 1 014780151

1479

trim pin remover

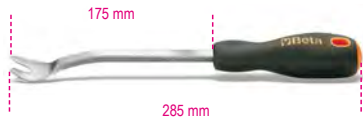

1479 € 23,90 2 014790001

1479/B27

kit of 27 nylon tools for removing pins and working on plastics and seals, hangable



1479/B27 € 75,00 1 014790407

1479LB/C5

kit of 5 metal trim pin removers



1479LB/C5 € 101,50 1 014790150
215x165x50 mm

1479L/S2

multipurpose wrecking bars, pair, made of Teflon®



1479L/S2 € 34,00 1 014790510

1479LV/S3

kit of 3 multipurpose wrecking bars, made of metal

sizes:
1479LV/1: 10x12 mm
1479LV/2: 4.8x9.6 mm
1479LV/3: 2.8x6 mm



1479LV/S3 € 28,50 1 014790100

1479L/K4

4 wrecking bars for jobs on dashboards and delicate parts



1479L/K4 € 32,50 1 014790604

1479ML/B17

kit of 17 multipurpose wrecking bars, made of plastic

particularly recommended for precision jobs



1479ML/B17 € 61,00 1 014790700

1479ML/S3

kit of 3 multipurpose wrecking bars, made of plastic

Particularly recommended for precision jobs



1479ML/S3 € 10,50 1 014790603

1479N/S5

kit of 5 nylon trim pin removers



1479N/S5 € 38,50 1 014790251

Beta

1479RB/1

straight putty knife scraper



1479RB/1 € 26,50 1 014790315

1479RB/2

bent putty knife scraper



1479RB/2 € 26,50 1 014790320

1479RB/3

flat putty knife scraper



1479RB/3 € 30,00 1 014790310

1479U/13

putty knife scrapers



1479U/13 € 24,40 2 014790010

1479U/32

trim pin remover, stainless steel blade



1479U/32 € 28,50 2 014790015

1480

Kit for filling diesel oil filters of cars without electric pumps

• Also for use with tyre inflators

Kit contents:

- GM quick couplings
- Renault, GM, Fiat quick couplings, inside Ø 6 mm
- Renault, GM, Fiat quick couplings, inside Ø 7 mm
- Ford quick couplings
- PSA quick couplings, inside Ø 6 mm
- PSA quick couplings, inside Ø 7 mm
- Ford quick couplings
- 2 cone-shaped adapters for cars without quick couplings



1480 € 362,00 1 014800010

410x320x70 mm

1481/C12

Kit of 6 pairs of hose pliers

Kit contents:

- 2 different pairs of pliers size 1/4"
- 2 different pairs of pliers size 3/8"
- 2 different pairs of pliers size 5/16"
- 3 pairs of rubber caps



1481/C12 € 114,50 1 014810312

370x270x59 mm

1481K/S4

kit of 4 self-locking terminals for line obstruction

sizes:
5/16" - 3/8" - 1/2" and loop



1481K/S4 € 28,50 1 014810400

1481PL/A

plastic hose pliers

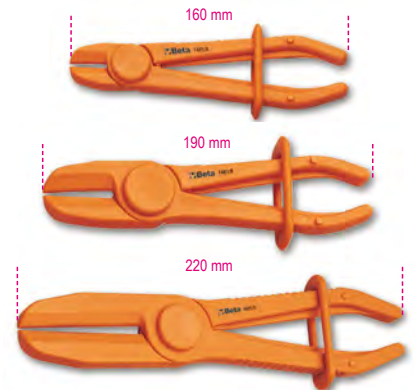

	Ø mm	€		
1481PL/A	8÷15	19,60	3	014810110
1481PL/B	15÷25	21,90	3	014810120
1481PL/C	25÷45	29,50	3	014810130

1481PL/S3

set of 3 plastic hose pliers



1481PL/S3 € 71,00 1 014810200

1481PL-A Ø 8÷15 mm
1481PL-B Ø 15÷25 mm
1481PL-C Ø 25÷45 mm



1481T/C12

set of fuel line plugs

3 pairs of plugs with male/female quick couplers for closing fuel lines



1481T/C12	€ 118,00	1	014810212
275x220x45 mm - 540 g			

1482

adjustable self-locking wrench for tank floating ring nuts



∅ mm	€		
89÷170	106,00	1	014820001
89÷200	111,00	1	014820002

1482A/1

3-leg wrench for floating ring nuts, tank with aluminium ring nut

For operating on aluminium ring nut installed on Fiat, Volkswagen, Opel, Chevrolet, Mercedes and BMW cars since 2011



∅ mm	€		
185	74,00	1	014820005

1482A/3

wrench for tank floating ring nuts, PSA group

So designed as to make it possible to operate on decentralized axis by removing ring nut, without damaging delicate fuel line



∅ mm	€		
157	84,00	1	014820007

1482A/5

wrench for tank floating ring nuts, 22 sectors

for use on plastic ring nuts in VAG group cars



12"	∅ mm	€	
	180	64,50	1 014820015

1482/8 - 1482/10

quick coupler pliers for fuel pipes

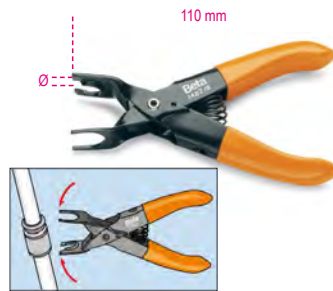

1482/8	∅ mm	€	
1482/10	8	36,50	2 014820008
	10	36,50	2 014820010

1482B

quick coupler pliers for fuel pipes



1482B	€		
	44,50	1	014820021

1482SN

quick coupler swivel pliers for fuel pipes, with articulated jaws



L mm	€		
260	56,00	1	014820110

1482C

wedges (2 pairs) for releasing diesel fuel filter fittings, Fiat, Volkswagen, Jeep, Chrysler and Volvo groups

Quick filter replacement without irreparably damaging fittings



1482C	€		
	58,50	1	014820022

1482D

quick coupler pliers for fuel pipes, with flexible extension



1482D	€		
	80,00	1	014820026

1483K/12

kit for removing valves from air-conditioning system with set of five-star head bits

Kit contents:

- 2 female octagon sockets, ∅ 12 and 15 mm, for high-pressure valves
- 2 male open end sockets, section 2.2 and 3.2 mm, for throttle valves
- 1 set of five-star head bits: PT10, PT15, PT20, PT25, PT27, PT30, PT40



1483K/12	€		
	38,50	1	014830012

120x80x35 mm

1483KV-PT/S7

set of five-star head bits

Included sizes: PT10 - PT15 - PT20 - PT25 - PT27 - PT30 - PT40



1483KV PT/S7	€		
	11,70	1	014830117

1483K/22

kit for separating couplers on air-conditioning, fuel supply and lubrication systems



1483K/22 € 133,00 1 014830022
300x230x55 mm - 1 kg

1484

set of 2 tools for removing and installing stretch belts
Allows stretch belt to be quickly removed and correctly installed, without risking damaging it



1484 € 117,00 1 014840010

1484PSA

tool for installing water pump stretch belt without belt tightener

for use for PSA and Opel group vehicles engines 1.0 - 1.2



1484PSA € 15,30 1 014840012

1485BP

half-moon tool for locking toothed pulleys

can be adjusted through swivel handle, tightens and locks pulley from outside, preventing neighbouring sensors from getting damaged



A Max mm 130 € 209,00 1 014850000

1485BPM

half-moon tool with aluminium jaws for locking multi-groove pulleys

can be adjusted through swivel handle; tightens and locks pulley from outside, preventing neighbouring sensors from getting damaged



A Max mm 180 € 180,50 1 014850002

1485FCA/K2

tools for pre-loading timing belt bearings, pair, FCA group
recommended for 1.2, 1.4 8/16 V and 1.4 Multiair engines

- 1 175-mm-long tool with 13.5-mm-deep push rods
- 1 305-mm-long articulated tool with 13.5-mm-deep push rods



1485FCA/K2 € 96,00 1 014850220

1485FCA/T

timing belt tensioner, long series, with 13.5 mm inserts



L mm 175 P mm 13,3 € 35,00 1 014850210

1485FCA/TS

timing belt tensioner, articulated, with 13.5 mm inserts



L mm 305 P mm 13,5 € 61,00 1 014850215

1485FRD/T

tensioning lever for service belts mounted on Ford engines
can be used to remove alternator pulleys



L mm 450 Q mm 12,80 € 75,00 1 014850310

1485MRC/T

tensioning lever for service belts mounted on Mercedes engines
for use with M133 - M270 engines

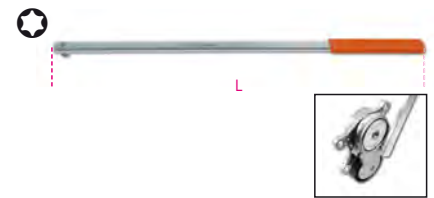

L mm 510 T55 € 30,50 1 014850315

1485VLV/T

tensioning lever for service belts mounted on Volvo engines

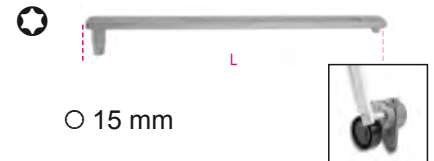

L mm 420 T50-T60 15 € 63,00 1 014850320

1485TC

tensioning lever for service belts, mounted on Ford, PSA, FCA engines



L mm 475 € 45,50 1 014850330

1485/KIT

kit for controlling cam belt tension



1485/KIT € 169,50 1 014850100
230x140x75 mm - 580 g



1485MJ

camshaft locking tool,
for 1.3 16V Multijet engines

2 3-form heads for working on all 1.3 16V Multijet engines
of FCA, Opel, Ford and Suzuki group vehicles



L mm	€	1	014850150
500	117,00		

1485PMTJ

driving shaft pulley release lever for Multijet
engines
so designed as to lock driving shaft
while removing pulley



L mm	€	1	014850190
450	122,50		

1485R

universal tool for rotating camshaft pulleys
made from forged steel
with 2 pairs of tips



Ø mm	Ø1 mm	L mm	€	1	014850025
30=120	10 - 17	500	146,00		

1485R/P10

pairs of inserts



€	1	014850035
15,60		

1485R/P17

pairs of inserts



€	1	014850038
15,60		

1485VAG/K2

tools for pre-loading
timing belt bearings, pair

- 3-position swivel head
- 1 tool with 12.5-mm-deep head
- 1 tool with 21.5-mm-deep head



€	1	014850080
73,00		

1485VAG

tools for pre-loading
timing belt bearings

- 3-position swivel head



L mm	P mm	€	1	014850062
190	12,5	36,00		
1485VAG/21,5	195 21,5	36,50		1 014850071

1486/10

wrench for natural gas cylinder valves

- VW group cars since 2008
- Panda from 2004 to 2012
- Grande Punto from 2005 to 2012
- Ducato since 2010
- new Doblò and Combo
- Cubo and Fiorino



36 mm

€	1	014860110
132,00		

1486/20

wrench for natural gas cylinder valves

- Multipla
- Ducato 1st and 2nd series until 2010
- Berlingo and Ranch
- C3 with iron cylinders
- Punto from 1999 to 2010
- Doblò 1st series
- Daily and Iveco group
- Dr5

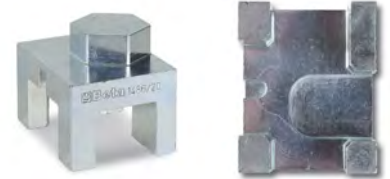

36 mm

€	1	014860120
132,00		

1486/30

wrench for natural gas cylinder valves

- Zafira 2nd series
- Combo 1st series

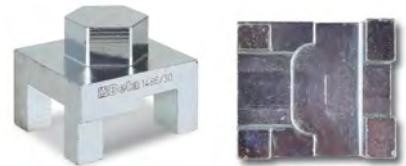

36 mm

€	1	014860130
132,00		

1486/40

wrench for natural gas cylinder valves

- Touran 1st series

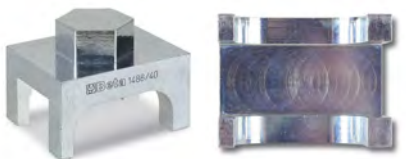

36 mm

€	1	014860140
132,00		

1486/50

wrench for natural gas cylinder valves

- Panda since 2012
- New Ypsilon



36 mm

€	1	014860150
132,00		

1486/60

wrench for natural gas cylinder valves

- C4 Picasso
- BRC systems



∅ 36 mm

1486/60 € 132,00 1 014860160

1486/70

wrenches for natural gas cylinder valves, pair

- C3 with composite cylinders



∅ 36 mm

1486/70 € 272,00 1 014860170

1486/80

wrench for natural gas cylinder valves

- B-Class
- Zafira 3rd series

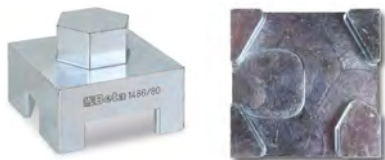

∅ 36 mm

1486/80 € 132,00 1 014860180

1486/90

wrench for natural gas cylinder valves

- Zafira 1st series
- Kangoo 1st series
- Sprinter

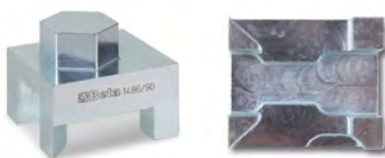

∅ 36 mm

1486/90 € 132,00 1 014860190

1487/K2

2 sockets for radiator drain plugs



17 mm

1487/K2 € 26,00 1 014870100

1488 - 1488L

oil-filter wrench with double chain



	∅ mm	€		
1488	60÷110	87,50	1	014880001
1488L	60÷160	96,00	1	014880050

1488/1

oil-filter wrench with thin double chain



	∅ mm	€		
1488/1	60÷110	101,50	1	014880010

1488R...

spare chain



		€		
1488RC	1488 350	36,00	1	014880101
1488R/L	1488/L 520	58,00	1	014880150
1488RC/1	1488/1	50,00	1	014880110

1489/31T

alternator pulley free wheel wrench



	∅ mm	€		
1489/31T	T50 15 31	36,50	1	014890016

1489/33

alternator pulley free wheel wrench



	€		
1489/33	33	15,60	1 014890010

1489/33P

alternator pulley free wheel wrench, for new Bosch FIAT Grande Punto alternators



	∅ mm	€		
1489/33P	M 10 15 31	46,50	1	014890015

1489/E

alternator pulley free wheel wrench



	∅ mm	€		
1489/E	10 15	31,50	1	014890025

1489R

alternator pulley free wheel wrench

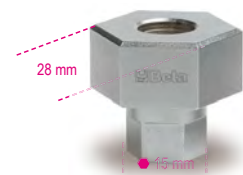

	€		
1489R	15,60	1	014890020

1489/Y

alternator pulley free wheel wrench, for Nippondenso alternators



	∅ mm	€		
1489/Y	32	18,00	1	014890040



1489/C14

assortment of 14 tools for free alternator pulleys



1489/C14 € 281,00 1 014890100

- 867PE 8 mm
- 867PE/L 8 mm
- 867XZN/L M10
- 867TX/L T50
- 867/2 □1/2"
- 920B 10 mm
- 1489/33
- 12 1489/33P M10
- 1489R
- 1489/Y
- 1489/31T T50
- 1489/E 10 mm
- 188 10 mm
- 188 15 mm

420x250x45 mm - 1,9 kg

1490

strap wrenches for oil filters



	Ø max mm	€		
1490/1	160	35,00	1	014900001
1490/2	240	37,50	1	014900002

1490/R1 - 1490/R2

spare fabric straps for item 1490



	Ø mm	€		
1490R/1	160	16,90	1	014900101
1490R/2	240	20,80	1	014900102

1490F

strap wrenches for filters



38" 12" Ø Max mm 200 € 25,50 1 014900201

1491

adjustable oil filter wrench



Ø mm 65÷110 € 45,50 2 014910001

1491R

spare metal band for item 1491



1491R € 8,20 10 014910010

1491A

adjustable oil filter pliers

Precision adjustment through rack



L mm	Ø min - Max mm	€		
345	55 ÷ 140	30,50	1	014910040

1491T

adjustable truck oil filter pliers

Precision adjustment through rack
For use with drier filters



L mm	Ø min - Max mm	€		
500	70 ÷ 200	71,50	1	014910050

1492/1 - 1492/2

adjustable oil filter wrenches



	Ø mm	€		
1492/1	60÷80	43,00	1	014920001
1492/2	80÷110	45,00	1	014920002

1492T

drier filter wrenches



	Ø mm	H mm	€		
1492T 40	125÷145	40	33,00	1	014920540
1492T 75	120÷140	75	57,50	1	014920575

1493B

bi-hex wrenches
for hard-to-reach oil filter cartridges



mm	± mm	€		
24	8	18,50	1	014930524
27	8	19,20	1	014930527
32	8	19,70	1	014930532
36	8	21,00	1	014930536
38	8	21,50	1	014930538

1493B/S5

set of 5 bi-hex wrenches
for hard-to-reach oil filter cartridges

sizes:
24-27-32-36-38 mm



1493B/S5 € 76,00 1 014930599

1493

oil filter wrench

12"



Ø mm	N	€	W	L
65	14	10,50	1	014930200
68	14	10,50	1	014930206
73	14	10,50	1	014930208
74	14	10,50	1	014930209
74	15	10,50	1	014930210
75-77	15	10,50	1	014930212
76	8	10,50	1	014930214
76	14	10,50	1	014930218
76-74	15	11,30	1	014930220
78	15	11,30	1	014930224
80	15	11,60	1	014930226
82-80	15	11,60	1	014930228
86	16	12,30	1	014930230
90	15	12,30	1	014930234
92	10	12,30	1	014930236
93	15	12,30	1	014930238
95	15	12,30	1	014930244
100	15	14,00	1	014930248
106	15	14,60	1	014930250
108	15	14,60	1	014930252
135	18	23,30	1	014930256

1493/PF

Purflux® oil-filter wrenches

12"



Ø mm	N	€	W	L
66	6	10,50	1	014930202
76	12	10,50	1	014930216
76	30	11,30	1	014930222
86	18	12,30	1	014930232
93	36	12,30	1	014930240
93	45	12,30	1	014930242
96	18	12,30	1	014930246
108	18	15,60	1	014930254

1493/C30

set of 28 oil filter wrenches

12"



Sizes included in kit (Ø mm / n°. of sides)

1493:

65/14 - 67/14 - 68/14 - 73/14 - 74/15
76/15 - 75.77/15 - 76/14 - 76/8 - 78/15 - 80/15
82/15 - 86/16 - 90/15 - 92/10 - 93/15 - 95/15
100/15 - 106/15 - 108/15

1493PF (Purflux)

66/6 - 76/12 - 76/30 - 86/18
93/36 - 93/45 - 96/18 - 108/18

- Includes 1 adjustable oil filter wrench
Ø 65=120 mm

1493/C30 € 253,00 1 014930000

530x400x110 mm - 4 kg

1493AL

oil filter wrenches

N= number of sides

38"

12"

Ø



Ø mm	N	•	□	€	W	L
64	14	27	1/2"	15,60	1	014930310
66,5	14	27	1/2"	14,00	1	014930315
74	14	27	1/2"	16,90	1	014930320
79	15	27	3/8"	15,60	1	014930325
84	14	27	3/8"	16,90	1	014930330
87	16	27	1/2"	21,00	1	014930335
92	15	27	3/8"	16,90	1	014930340
94,5	15	27	3/8"	16,90	1	014930345
100,5	15	27	3/8"	16,90	1	014930350

1493AL 4S

oil filter wrenches

for Asian cars

4-hook profile

38"

Ø

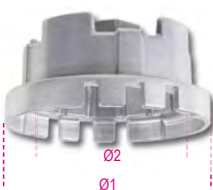

Ø1 mm	Ø2 mm	€	W	L
70	64,5	27	1	014930304
80	64,5	27	1	014930305

1493AL CF

hexagon socket wrenches
for oil filter cartridges

12"

H

Ø



Ø mm	H mm	•	€	W	L
24	34	27	10,10	1	014930424
27	34	27	10,10	1	014930427
30	34	27	10,10	1	014930430
32,5	34	27	10,50	1	014930432
36	34	27	10,50	1	014930436
38	34	27	10,50	1	014930438

1493/C19

set of 18 oil filter wrenches,
particularly suitable for Asian cars

Ø mm N°. of sides

63-64 14
66.5 14
74 14
79 15
84 14
87 16
92 15
94.5 15
100.5 15

64.5 14 hook wrench for Toyota cars
64.5 14 hook wrench for Lexus cars

6 hexagon sockets, sizes 24-27-30-32.5-36-38 mm, for filter cartridges

Kit includes 1 universal adjustable wrench Ø 58+93 mm

12"

38"



1493/C19 € 222,00 1 014930019

490x450x60 mm - 4 kg

1493DSG

wrench for removing/installing
DSG oil filter

Ø

12"



Ø mm	€	W	L
24	35,50	1	014930800



1493FF

wrench for removing/installing plastic seats of Ford Peugeot Citroën oil filters engines: TDCi-HDi

Allows plastic seat to be correctly tightened at 25 Nm by means of a torque wrench



12" 27 mm € 28,50 1 014930127

1493FT

wrench for Ford Transit Diesel oil filters

Can be used for all Transit, Transit Custom and Tourneo Custom versions manufactured since 2012



12" 115 mm € 24,20 1 014930085

1493J

wrench for MultiJet

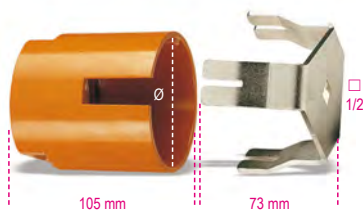

12" 90 mm € 111,00 1 014930080

1493VW

diesel oil filter wrench, for VAG and Volvo cars



12" 82,5 mm € 16,20 1 014930086

1493HK

diesel oil filter wrench for Hyundai Kia, 15-sided



12" 15x € 26,00 1 014930087

1493/C7

self-adjusting oil filter wrench with three arms for right- and left-hand tightening, with interchangeable arms

antislip diamond finish

- 2 sets of arms:
- 1 set with 20 mm working length
- 1 set with 38 mm working length



1493/C7 50±100 mm 16 mm € 107,50 1 014930079
210x150x50 mm

1493H

self-adjusting oil filter wrench with 3 arms, for right and left hand tightening

Knurled jaws

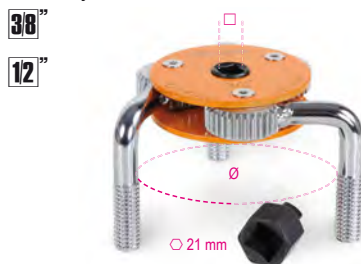

12" 38" 72±127 mm € 26,50 1 014930077

1493/S-U

self-adjusting oil filter wrench with 3 arms, for right and left hand tightening



1493/S 3/8-1/2 80-115 mm € 80,50 1 014930074
1493/U 1/2 105-165 mm € 176,00 1 014930076

1493X

self-locking oil filter wrenches, for left-hand tightening



1493X/1 60±80 mm 2,9 mm € 30,50 1 014930105
1493X/2 80±98 mm 2,9 mm € 30,50 1 014930110

1493Y

self-locking oil filter wrenches, for right- and left-hand tightening, heavy-duty version

item 1493Y/2 can also be used for drier filters



1493Y/1 80±110 mm 7,3 mm € 104,50 1 014930120
1493Y/2 104±145 mm 7,3 mm € 159,00 1 014930122

1493C/ADB

socket for opening AdBlue® caps, for PSA group vehicles



1493C/ADB 17 mm € 15,80 1 014930900

Beta

1493U/ADB

socket for opening AdBlue® drain plugs

38"



1493U/ADB	€ 11,40	1	014930910
-----------	---------	---	-----------

1494T/C5

set of special sockets for plastic oil drain plugs

Set contents:

- 1 socket for VAG group oil drain plugs
- 1 socket for BMW oil drain plugs
- 1 socket for PSA and Ford group oil drain plugs
- 1 socket for Mercedes oil drain plugs
- 1 "T"-handle wrench

38"



1494T/C5	€ 69,00	1	014940350
----------	---------	---	-----------

173x125x50 mm - 360 g

1494BMW

special socket for plastic oil drain plugs, for BMW engines

38"



1494BMW	€ 13,40	1	014940315
---------	---------	---	-----------

1494FPC

special socket for plastic oil drain plugs, for Ford, Peugeot and Citroën engines

38"



1494FPC	€ 15,10	1	014940320
---------	---------	---	-----------

1494VW

special socket for plastic oil drain plugs, Volkswagen engines

Allows plastic plug to be removed and installed from oil sump. Specially designed for Volkswagen cars with TFSI and TDI engines

38"



1494VW	€ 21,00	1	014940305
--------	---------	---	-----------

1494MRC

special socket for plastic oil drain plugs, for Mercedes engines

38"



1494MRC	€ 14,80	1	014940325
---------	---------	---	-----------

1494MAN

special socket for plastic oil drain plugs, for DAF and MAN engines

38"



1494MAN	€ 14,80	1	014940330
---------	---------	---	-----------

1494

square oil drain plug socket

12"



mm	€		
10	8,75	1	014940280

1494E

male hexagon oil drain plug sockets

12"



mm	€		
8	8,75	1	014940208
9	8,75	1	014940209
10	8,75	1	014940210
11	8,75	1	014940211
12	8,75	1	014940212
14	8,75	1	014940214
17	8,75	1	014940217

1494Q

male square oil drain plug sockets

12"



mm	€		
8	8,75	1	014940258
9,5	8,75	1	014940259
12	8,75	1	014940262
13	8,75	1	014940263

1494T

male triangular oil drain plug socket

12"



mm	€		
9,5	8,75	1	014940289

1494XZN

male oil drain plug socket with XZN® profile

12"



M	€		
16	10,50	1	014940296

1494VW/K

engine oil replacement kit, for VAG cars



Kit contents:

- 1 special socket for plastic oil drain plugs
- 6 plastic oil sump plugs

1494VW/K	€ 27,50	1	014940310
----------	---------	---	-----------



1494/C14A

assortment of 14 oil change tools

12"



1494/C14A € 125,50 1 014940150

- 1494E 8-9-10-11-12-14-17
- 1494Q 8-9,5(3/8")-12-13
- 1494 10
- △ 1494T 9,5(3/8")
- 1494XZN M16

380x305x40 mm - 1,7 kg

1494M

tool for hexagon oil drain plugs, magnetic, flexible

Allows plug to be unscrewed without risking getting burnt or dirty



L mm 293 F kg 2,5 Ø mm 19 € 22,50 1 014940401

1495/C6

assortment of tools for repairing oil sump threads



• Damaged thread is removed by screw tap and enlarged by one size

• Allows repairs and avoids replacing oil sump

- Contents:
- 1 screw tap M13x1.25 + 6 screws + 12 washers
 - 1 screw tap M13x1.5 + 6 screws + 12 washers
 - 1 screw tap M15x1.5 + 6 screws + 12 washers
 - 1 screw tap M17x1.5 + 6 screws + 12 washers
 - 1 screw tap M20x1.5 + 6 screws + 12 washers
 - 1 screw tap M22x1.5 + 6 screws + 12 washers

1495/C6 € 271,00 1 014950500

420x185x60 mm - 2,1 kg

1495M

screw tap for oil drain plug threads



M	€	1	014950553
13x1,25	16,30	1	014950553
13x1,50	13,40	1	014950563
15x1,50	14,60	1	014950565
17x1,50	16,30	1	014950567
20x1,50	18,00	1	014950570
22x1,50	23,20	1	014950572

1495T

kit with 6 oil drain plugs and washers



M	€	1	014950503
13x1,25	19,00	1	014950503
13x1,50	19,00	1	014950513
15x1,50	19,00	1	014950515
17x1,50	21,00	1	014950517
20x1,50	23,70	1	014950520
22x1,50	31,00	1	014950522

1496/C

oil plug wrench



8 x 10 mm € 20,80 3 014960010

1497D

relay removal pliers, straight pattern



A min+Max mm 15÷50 € 31,50 1 014970150

1497P

relay removal pliers, bent pattern, 60°



A min+Max mm 15÷50 € 32,50 1 014970160

1497TE

pliers for disconnecting electrical connectors

the extremely thin noses allow the clips to be released without damaging the connectors



L mm 215 A Max mm 63 Ø mm 4 € 22,70 1 014970180

1497/C23

assortment of 23 tools for releasing electrical connectors



1497/C23 € 213,00 1 014970200

440x250x70 mm - 1,7 kg



1497/C94

assortment of 94 car testing connectors for use with main diagnostic tools

- 2 t-taps
- 2 potentiometers
- 2 warning lights
- 2 SRS connectors
- 2 alligator clips
- 2 acicular probes
- 2 prods
- 2 dual banana connectors
- 4 single banana connectors
- 24 flat male terminals 0.6+6 mm
- 12 round male terminals 1.6+3.9 mm
- 24 flat female terminals 0.6+6 mm
- 12 round female terminals 1.6+3.9 mm



1497/C94 € 375,00 1 014970300
430x390x100 mm - 3 kg

1497RC

t-taps, pair

- cable section: 1.5+3.5 mm
- voltage: 0+330V
- max. current: 5A



1497RC € 71,00 1 014970351

1497KB/S3

3 tool kit for removing Knorr and Bremse electrical connectors

- 1 tool for bayonet connectors
- 1 single head tool for 2-pole connectors
- 1 double head tool for 4- or 6- and 12-pole connectors



1497KB/S3 € 78,00 1 014970050

1497/S3

set of 3 cables for electrical signal detection

- 1 straight pc.
- 1 45° pc.
- 1 90° pc.



1497/S3 € 17,60 1 014970400

1498

voltage tester

CE

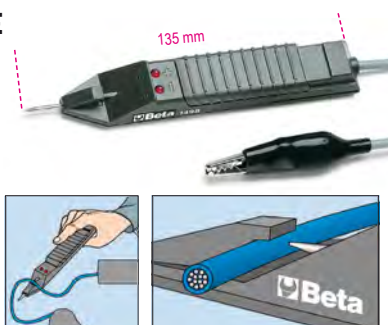

3÷48V € 46,50 2 014980100

1498MN/12

multipurpose portable starter

- Motor vehicle starting with 12-volt battery (diesel and petrol engines up to 2,000 cc)
- Charging of tablets, mobile phones and electronic devices in general
- Multi-use LED torch



Standard Accessories:

- Lithium-cobalt battery
- Starting cables with insulated clamps and device protecting against polarity reversal and short circuits
- USB outlet for charging electronic devices
- Digital display and battery charge indicator
- USB cable with charge adapters
- Mains and car power supplier

Technical Data:

- Pickup current: 600A
- Battery type: LiCoO2
- Starting output: 12 volts

1498MN/12 € 343,00 1 014980000

1498MN/12-C

booster cable with clamps for item 1498MN/12



1498MN/12-C € 56,00 1 014980005

1498MN/12-R

mains power supplies for mini starter LT/12-R



1498MN/12-R € 41,50 1 014980003

1498MN/12-P

car socket power supply for mini starters LT/12-P



1498MN/12-P € 24,90 1 014980004

1498MN/12-U

USB cables with universal U adapters



1498MN/12-U € 18,20 1 014980009



1498LT/12

portable high-performance starter,
ultralightweight



CE



Technical Data:

- Operating voltage: 12 V
- Continuous amperage: 800 A
- Maximum pickup amperage: 2000 A
- Peak amperage: 4000 A
- Cable length: 500 mm
- Battery type: 4-cell LifePo4
- Memory saving function: YES
- Dimensions: 260 x 135 x 72 mm
- Net weight: 2.5 kg
- Complete with charging power supply 12 V 1.3A

1498LT/12 € 800,00 1 014980012

1498LT/12-SF

wall fixing bracket for starter 1498LT/12



1498LT/12-SF € 133,00 1 014980013

1498LT/12-R7

mains power supply for starter 1498LT/12



1498LT/12-R7 € 57,50 1 014980657

1498LT/12-24

portable high-performance starter,
12-24 V, ultralightweight,

suitable for use on cars, commercial vehicles
and trucks



CE



The microprocessor provides total protection against:

- polarity reversal
 - short circuits
 - incorrect voltage
 - overloads
 - underdischarge
 - overcharge
 - overtemperature
- TECHNICAL DATA
- operating voltage: 12/24V
 - continuous amperage: 2000/1000 A
 - maximum starting amperage: 5000/2500 A
 - peak amperage: 10000/5000 A
 - clamp amperage: 1000 A
 - cable length: 160 cm
 - cable section: 25mm²
 - automatic power supply: 4 Amp
 - memory saving function
 - dimensions: 350x240x140 mm
 - weight: 5 kg

1498LT/12-24 € 1.585,00 1 014980014

1498/12

Portable car starter, 12V



CE



TECHNICAL DATA:

- Pickup current: 2200A
- Shoulder strap included
- Sealed lead acid battery, solid electrolyte (AGM) type

1498/12 € 664,00 1 014980480

13 kg

1498/24

portable car and commercial vehicle starter,
12-24V



CE



Technical Data:

- Pickup current: 4200A (12V) - 2100A (24V)
- Shoulder strap included
- Sealed lead acid battery, solid electrolyte (AGM) type
- Weight: 17 kg

1498/24 € 1.340,00 1 014980490

1498B12/R02

12V spare battery
for starters 12-24V



1498B12-R02 € 289,00 1 014980502

1498/12-24 R20

mains power supply for starters items 1498/12
and 1498/24



1498/12-24 R20 € 69,00 1 014980520

 Beta

 Beta

1498/2A

electronic motorcycle battery charger, 12V

allows charging of all Pb Wet, Agm, Gel, Mf and Vrla battery types and LiFePo4 lithium batteries



- Two different types of charge, for lithium and lead acid batteries respectively
- Automatic multi-stage charge cycle
- Reverse polarity and short-circuit protection
- IP65 degree of protection
- Complete with cable with clamps and cable with eyelets
- Power supply voltage: 220-240V

TECHNICAL DATA

- Charging current: 1A
- Charging capacity: 2Ah-40Ah
- Frequency: 50-60 Hz
- Battery voltage: 12V
- Dimensions: 180x80x40 mm
- Weight: 0.5 kg

1498/2A € 122,00 1 014980102

1498/4A

Electronic car/motorcycle battery charger, 6-12 V



- Protected against polarity reversal and short circuits
- Automatic 6 V or 12 V selection
- Automatic battery type selection
- Digital backlit display
- Pull-back fixing hook

TECHNICAL DATA

- Power supply voltage: 220V-240V
- Frequency: 50-60 Hz
- Rated current (min-max): 1-4 Amp
- Battery voltage: 6V/12V
- Battery capacity: 4Ah-80Ah
- Charging time: 12 hours
- Degree of protection: IP65

1498/4A € 149,00 1 014980104

1498SA/2A-4A

cable with cigarette lighter plug for items 1498/2A and 1498/4A



1498SA/2A-4A € 31,00 1 014980120

1498/8A

Electronic car / commercial vehicle battery charger, 12 V



Features:

- Slow and quick charge (2A-8A)
- Flat battery recovery function
- Power supply function 13.8V-5A
- Protected against polarity reversal and short circuits
- Manual battery type selection
- Digital backlit display
- Pull-back fixing hook

Technical data:

- Power supply voltage: 220V - 240V
- Frequency: 50-60 Hz
- Rated current (min-max): 2-8 Amp
- Battery voltage: 12V
- Battery capacity: 5Ah-160Ah
- Memory saving feature: 13.8V - 5A
- Degree of protection: IP65

1498/8A € 210,00 1 014980108

1498/4A-8A CO

eyelet cable for items 1498/4A and 8A



1498/4A-8A-CO € 15,00 1 014980114

1498/4A-8A CP

cable with clamps for items 1498/4A and 8A



1498/4A-8A-CP € 19,30 1 014980118

1498/2A-8A-PR

extension for item 1498/2A/4A/8A



1498/2A-8A-PR € 36,00 1 014980119

1498/16A

electronic multipurpose battery charger, 12-24V



- Backlit graphic display
- Max. charging current: 16A, continuous
- Charging and charge maintenance
- Protected against polarity reversal and short circuits
- 9 charging steps
- Floating system
- Show room function (13.8V - 12A)
- Supply function (14V - 12A)
- Memory saving function (13.8V - 12A)
- Battery recovery function
- Clamp holder
- Reclining hook fastening
- Supplied accessories: cable with clamp, cable with eyelets

Technical data:

- Power supply: 220-240V
- Power: 240W
- Charging current: 4-16A
- Battery types: Agm - Wet - Lithium (LiFePo4)
- Charging capacity: 5-360Ah
- Maintenance capacity: 5-550Ah
- Output voltage: 12-24V
- Minimum battery voltage: 0.8V
- Degree of protection: IP20

1498/16A € 442,00 1 014980126



1498/120A

electronic multipurpose
battery charger, 12V

Allows batteries to be charged
and powers motor vehicles
while reprogramming and self-diagnosing



- maximum continuous charging current: 120A
- charging and maintenance with CPU microprocessor
- battery recovery function
- reprogramming and power supply for ECU
- protected against polarity reversal, short circuits, incorrect voltage and overload

TECHNICAL DATA

Power supply: 90-260V
Power: 1500W
Charging current: 10-120A
Battery type: Agm - Wet - Lithium (LifePo4)
Charging capacity: 10-1200Ah
Maintenance capacity: 5-3600Ah
Output voltage: 12 Volt
Cable length, with clamps: 2700 mm
Dimensions: 310 x 150 x 350 mm
Weight: 8.5 kg

1498/120A € 2.740,00 1 014980142

1498/40A

multipurpose battery charger / starter, 12-24V
wheeled

Since no internal battery is available, the start function (max. 350A)
does not replace that of a specific starter type 1498LT/12 (2000A).



- 3 programmed charging cycles and 1 manual cycle
- electronic adjusting potentiometer
- specific WET-SPIRAL/GEL-AGM charging cycles
- electronic control and protection system
- 10-stage charging process
- battery desulfurization and recovery function
- supply function
- dual voltage, 12-24V
- also suitable for Start&Stop batteries
- professional rubber-insulated brass clamps

TECHNICAL DATA

Power supply: 230V
Output voltage: 12-24V
Charging current: 1-40A
Starting current: 350A max cc
Charging capacity: 4-450Ah

1498/40A € 1.113,00 1 014980140
330x250x792

1498SM

memory saver, 12 V

prevents data stored by computer on board cars
from getting lost during maintenance jobs
or battery replacement.



Technical specifications:

- self-supplied
- internal battery Pb 5 Ah
- 12 volts
- professional connection with OBD socket

1498SM € 238,00 1 014980020

1498SM-C

OBd II car memory saver connectors, 12V, for
item 1498SM/C



1498SM-C € 26,00 1 014980021

1498SM-CP

car memory saver connectors, 12V clamp, for
item 1498SM/CP



1498SM-CP € 23,90 1 014980022

1498SM-A

memory saver power supplies for item
1498SM/A



1498SM-A € 26,50 1 014980023

1498TB/12-24

digital battery tester, 12V,
and starting/charging system analyzer, 12-24V

- allows the following to be tested: battery, alternator (smart and normal) and starter, diode ripple and chassis test
- fitted with software for printing test from PC
- backlit display
- compact, shockproof frame
- 10 language software
- complete with input for connecting a removable mini printer (optional accessory, Beta 1498ST/TB)



Technical Data:

- Applications: 12V battery test - Alternator charge test, 12-24V - Starter test
- Operating range: 100-2000 CCA
- Reference standards: CCA, SAE, DIN, EN, IEC, JIS
- Supported batteries: PB, WET, GEL, AGM, AGM FLAT, EFB
- Voltmeter: 9V-36V
- Cable length: 1600 mm
- Languages: Italian, English, French, German, Spanish, Polish, Romanian, Dutch, Swedish and Finnish
- Accessories included: USB cable and software

1498TB/12-24 € 632,00 1 014980401



1498ST/TB

mini thermal printer
for tester item 1498TB/12

- Mini printer can be directly connected to tester
- Allows test results to be printed



CE

1498ST/TB € 226,00 1 014980410

1498ST/TB ROT

paper refill
for printer 1498ST/TB



1498ST/TB ROT € 10,90 2 014980411

1498PC

voltage stabilizer, 12-24 V

Protects control units
in welding and starting processes



1498PC € 94,50 1 014980801

Beta

1498TC

digital glow plug tester

Quick, accurate glow plug testing

- Suitable for all types of glow plugs, 4.4-5-7-8.5-10-11 Volts
- Digital backlight display
- Suitable for steel and ceramic glow plugs
- Short circuit and polarity reversal protection
- Turns off automatically when not in use
- With buzzer
- With SMD LED torch
- Compact, shockproof frame



CE

- Measurement range: 0.00÷25.0Ω
- Tolerance: ± 2%
- Resolution: 0.01
- Led Display: 1.8"
- Operating temperature: 0°C÷50°C
- Power supply: 1 9V battery (not included)

1498TC € 191,50 1 014980450

1499

sonoscope probe



1499 € 95,00 1 014990001

1500/...

two-leg universal pullers

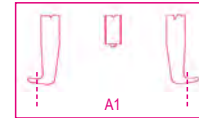

	L mm	€		
1500/1	100	79,00	1	015000301
1500/2	100	83,00	1	015000302
1500/3	150	137,50	1	015000303
1500/4	150	189,50	1	015000304
1500/5	205	344,00	1	015000305
1500/6	205	403,00	1	015000306
1500/7	205	604,00	1	015000307
1500/8	230	966,00	1	015000308

	A min÷Max mm	A1 min÷Max mm
1500/1	25÷80	70÷130
1500/2	25÷130	80÷180
1500/3	50÷160	105÷220
1500/4	60÷200	120÷270
1500/5	80÷250	160÷330
1500/6	80÷350	160÷420
1500/7	110÷520	195÷600
1500/8	170÷640	260÷715



1500/SP5 € 894,00 1 015000325
1500/1-1500/2-1500/3
1500/4-1500/5
1500/SPV € 77,00 1 015000001

1500G/...

legs, pair, standard series,
for items 1500 and 1580/8I



	mm	iii 1500	€		
1500G/1	35	/1-2	51,00	1	015000311
1500G/3	35	/3-4	75,50	1	015000313
1500G/5	35	/5-6-7	153,00	1	015000315
1500G/8	50	/8	188,00	1	015000317
		1580/8I			



1500N/...

universal pullers with 2 sliding legs

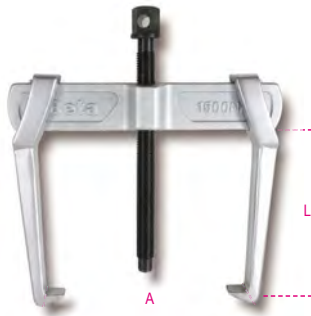

	A min+Max mm	L mm	€	🔧	📦
1500N/0	18+65	70	71,00	1	015000600
1500N/1	23+70	100	74,50	1	015000601
1500N/2	23+100	100	80,00	1	015000602
1500N/3	35+140	150	133,50	1	015000603
1500N/4	35+190	150	143,50	1	015000604
1500N/5	43+250	205	276,00	1	015000605
1500N/6	43+320	205	299,00	1	015000606



1500N/SP6	778,00	1	015000626
1500N/0-1500N/1-1500N/2-1500N/3			
1500N/4-1500N/5			
1500N/SPV	94,00	1	015000006

1500N/G...

loose legs for pullers 1500N



	± mm	fit 1500N	€	🔧	📦
1500N/G0	10	/0	23,50	2	015000650
1500N/G1-2	12	/1-2	25,00	2	015000651
1500N/G3-4	17	/3-4	44,50	2	015000653
1500N/G5-6	23	/5-6	86,00	2	015000655

1501/1-2-3

thin leg pullers

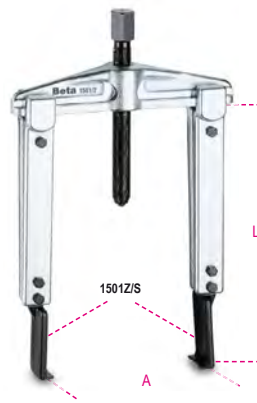

	L mm	€	🔧	📦
1501/1	100	178,50	1	015010101
1501/2	200	189,50	1	015010102
1501/3	250	198,50	1	015010103

	A min+Max mm	€	🔧	📦
1501/1	25+130			
1501/2	25+130			
1501/3	25+130			

1501G/1-2-3

legs for item 1501



	L mm	€	🔧	📦
1501G/1	100	98,50	1	015010111
1501G/2	200	114,50	1	015010112
1501G/3	250	124,50	1	015010113

1501Z/S - P - R

leg ends for item 1501G



	± mm	D mm	€	🔧	📦
1501Z/S	2,0	27	35,50	2	015010211
1501Z/P	3,6	27	36,00	2	015010212
1501Z/R	3,6	14	40,50	2	015010213

1502/...

two-leg universal pullers
with quick leg adjustment and closure

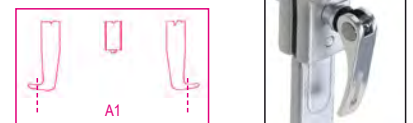
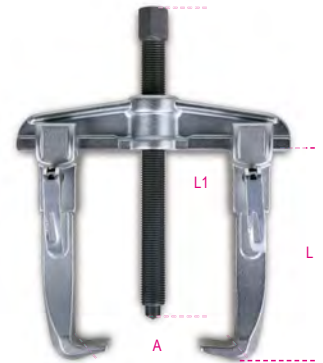

	L mm	L1 mm	€	🔧	📦
1502/0	100	166	117,00	1	015020000
1502/1	100	166	127,50	1	015020001
1502/2	150	247	202,50	1	015020002
1502/3	150	247	224,00	1	015020003
1502/4	200	321	385,00	1	015020004

	A min+Max mm	A1 min+Max mm
1502/0	40+90	80+130
1502/1	50+130	90+170
1502/2	65+150	115+210
1502/3	65+190	125+260
1502/4	70+235	170+335

1505V

windshield and rear window wiper
arm remover

Removable perforated brass tip
for arm removal, with built-in washer jet



	A Max mm	L mm	€	🔧	📦
1505V	43	37	41,50	1	015050001

1505/C5

windshield wiper removal kit

1 two-leg puller, Ø 25÷40 mm
4 half-moon tools, Ø 25 mm, Ø 30 mm, Ø 35 mm, Ø 41 mm



mm 12 € 138,50 1 015050300

320x150x60 mm - 1,2 kg

1506

two-leg self-locking puller



	A min+Max mm	L mm	L1 mm	€		
1506	10÷50	80	40	43,00	1	015060001

1508/1 - 1508/2

two-leg pullers, light series

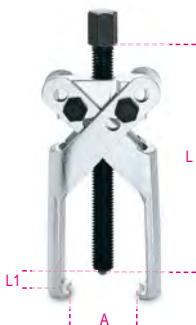

	L mm	€		
1508/1	105	142,00	1	015080001
1508/2	130	169,00	1	015080002

	A min+Max mm	L1 mm
1508/1	6÷100	85
1508/2	10÷140	120



1511/1-2-3

external pullers with two reversible legs

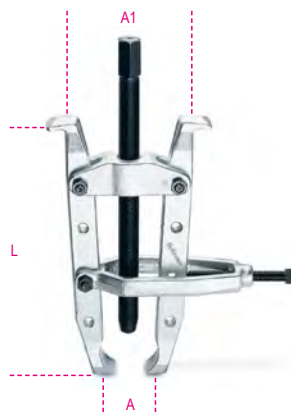

	L mm	€		
1511/1	235	240,50	1	015110001
1511/2	330	301,00	1	015110002
1511/3	405	374,00	1	015110003

	A min+Max mm	A1 min+Max mm
1511/1	20÷100	65÷95
1511/2	40÷150	103÷190
1511/3	40÷150	103÷175

1515/1-2-3

pullers with two floating legs



	L mm	€		
1515/1	85	31,50	1	015150101
1515/2	85	33,50	1	015150102
1515/3	105	50,00	1	015150103

	A Max mm	L1 mm
1515/1	60	105
1515/2	70	105
1515/3	90	105

1516/1-2-3

pullers with three floating legs



	L mm	€		
1516/1	85	45,50	1	015160001
1516/2	85	48,50	1	015160002
1516/3	105	69,00	1	015160003

	A Max mm	L1 mm
1516/1	60	85
1516/2	70	85
1516/3	90	105

1517

three-leg self-locking pullers

- For major pulling loads.
- Self-locking effect.



	L mm	L1 mm	Ø mm	€		
1517/90	182	60	22	247,50	1	015170000
1517/150	242	115	22	253,00	1	015170010
1517/200	307	150	22	292,00	1	015170020
1517/260	395	180	30	339,00	1	015170030

	mm	A mm	kg	N
1517/90	19	18÷90	6000	59000
1517/150	19	25÷150	6000	59000
1517/200	19	40÷200	6000	59000
1517/260	27	50÷260	8000	78500



1517C TWO/THREE-LEG SELF-LOCKING PULLERS FOR EXTERNAL USE

Beta's puller 1517C relies on a leg self-locking mechanism triggered by the spring on the crosspiece. This feature makes it easy to position and lock the puller on the part to remove. After the puller has been fixed in place, the legs can be locked by means of the ring nut.

The peculiar crosspiece has 4 seats which allow the 1517C puller to be used with both 2 legs – for easier, quicker jobs – and 3 legs – for increased firmness.

The shear pin on the screw head breaks when the maximum permissible torque is exceeded, thereby protecting the puller from overloads.



1517C/...

combination two/three-leg self-locking pullers

- for 2- or 3-leg use
- self-locking effect



	L mm	L1 mm	€		
1517C0	145	250	209,00	1	015170500
1517C1	200	300	257,00	1	015170501
1517C2	270	300	319,00	1	015170502

	A mm	● mm
1517C0	12÷140	18
1517C1	20÷180	18
1517C2	30÷280	18

1518/...

three-leg pullers



	L mm	€		
1518/1	105	76,50	1	015180001
1518/2	135	98,00	1	015180002
1518/3	235	173,50	1	015180003
1518/4	270	258,00	1	015180004
1518/5	270	303,00	1	015180005
1518/6	270	317,00	1	015180006

	A min÷Max mm	L1 mm
1518/1	24÷100	105
1518/2	32÷160	150
1518/3	40÷220	220
1518/4	80÷250	240
1518/5	80÷300	350
1518/6	80÷350	400

1518U/...

three-leg universal pullers

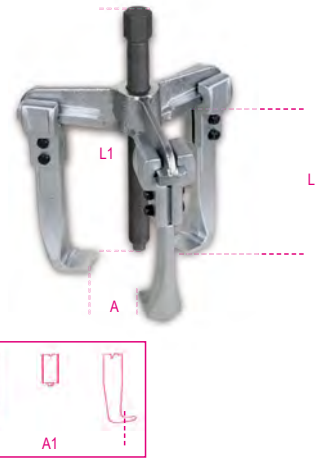

	L mm	L1 mm	€		
1518U/0	100	166	144,50	1	015180500
1518U/1	100	166	155,00	1	015180501
1518U/2	150	247	234,50	1	015180502
1518U/3	150	247	245,50	1	015180503
1518U/4	200	321	354,00	1	015180504

	A min÷Max mm	A1 min÷Max mm	● mm
1518U/0	40÷90	80÷130	17
1518U/1	50÷130	90÷170	17
1518U/2	65÷150	115÷210	22
1518U/3	65÷190	125÷260	22
1518U/4	70÷235	170÷335	27

1519/...

three-leg universal pullers
with quick leg adjustment and closure

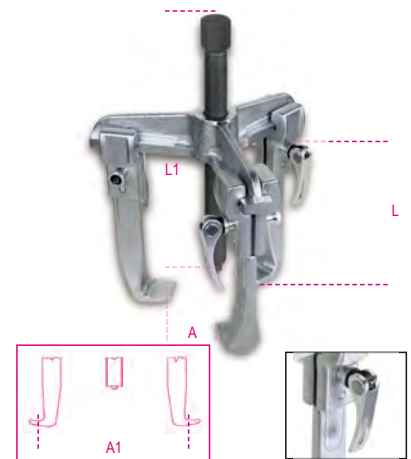

	L mm	L1 mm	€		
1519/0	100	166	166,00	1	015190000
1519/1	100	166	176,50	1	015190001
1519/2	150	247	252,00	1	015190002
1519/3	150	247	268,00	1	015190003

	A min÷Max mm	A1 min÷Max mm	● mm
1519/0	40÷90	80÷130	17
1519/1	50÷130	90÷170	17
1519/2	65÷150	115÷210	22
1519/3	65÷190	125÷260	22

Beta

1520/1 - 1520/2

pullers with two reversible legs



	L mm	€		
1520/1	135	73,00	1	015200101
1520/2	235	124,50	1	015200102

	A Max mm	L1 mm
1520/1	110	85
1520/2	160	140

1521/1 - 1521/2

pullers with three reversible legs



	L mm	€		
1521/1	135	94,00	1	015210101
1521/2	235	165,50	1	015210102

	A Max mm	L1 mm
1521/1	110	90
1521/2	160	140

1528

self-locking puller
for brake discs



∅ 19 mm

	A min+Max mm	€		
	170÷380	167,00	1	015280000

≡ 480x240x60 mm - 4,8 kg

1529

multi-step cone pulley puller

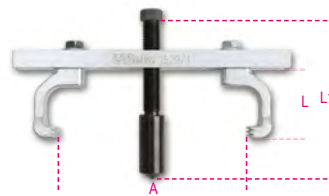

	A min+Max mm	L min+Max mm	L1 min+Max mm	€		
	24÷240	60÷95	90÷135	246,00	1	015290000

≡ 260x210x60 mm - 2,6 kg

1529/C7

pulley puller

Kit contents:

- 2 legs with two 4.7-mm-thick feet
- 2 legs with one 4.3-mm-thick foot
- 1 leg with two 2.3-mm-thick feet
- 1 leg with one 2.3-mm-thick foot

The pair of legs can be made up according to one's operating requirements



	L mm	L1 mm	A min+Max mm	€		
1529/C7	50	72,5	53÷114	143,00	1	015290100

≡ 285x155x50 mm - 2 kg

1529PI

universal injection pump pulley puller

- Allows fuel injection pump pulley to be quickly and accurately removed.
- Particularly suitable for Fiat, Ford, Volkswagen, Citroën and Peugeot vehicles.

Includes 3 pairs of screws for tightening puller to pulley:

M6 x 1.0 x 49 mm

M7 x 1.0 x 75 mm

M8 x 1.25 x 76 mm



1529PI	102,50	1	015290051
--------	--------	---	-----------

1529/PG

high-pressure diesel oil pump puller,
for VAG group vehicles

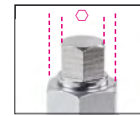

	∅ mm	€		
	15-24	63,00	1	015290010

1530/C5

wheel hub and bearing pulling kit,
3, 4, 5 holes

Kit contents:

- 1 universal flange (96÷138 mm)
- 1 hydraulic screw (12 t)
- 1 hammer face (2.8 kg), required for hubs without central fixing bolts



1530/C5	516,00	1	015300300
---------	--------	---	-----------

≡ 760x320x120 mm - 11,5 kg

1530/C16

hammer face kit with spacing studs,
for pulling wheel hubs and bearings
3, 4, 5 holes

Ideal for hubs with projecting centre rings

Kit contents:

- 1 universal flange (90÷130 mm)
- 1 hammer face (5 kg)
- 4 M12 coupling studs
- 4 M14 coupling studs



1530/C16	635,00	1	015300316
----------	--------	---	-----------

≡ 760x310x100 mm - 13,5 kg

1531/C7

removal kit for hub wheel bearing inner rings

included sizes:

- 1 pliers Ø 40÷45 mm
- 1 pliers Ø 45÷51 mm
- 1 pliers Ø 50÷55 mm
- 1 pliers Ø 55÷61 mm



1531/C7 € 698,00 1 015310107

390x315x96 mm - 4,3 kg

1532

packing and oil seal removal tool



1532 € 16,20 2 015320001

1533/...

pullers for separators 1534



	L mm	€		
1533/2	150	105,50	1	015330002
1533/3	210	200,50	1	015330003
1533/4	315	318,00	1	015330004
1533/5A	305	385,00	1	015330006

	A min÷Max mm	L1 mm
1533/2	45÷140	110
1533/3	55÷205	175
1533/4	90÷260	175
1533/5A	100÷360	235

1533PR/1 - 2 - 3

extensions for pullers 1533



	€		
1533PR/1	23,10	1	015330011
1533/2			
1533PR/2	24,70	1	015330012
1533/3			
1533PR/3	26,00	1	015330013
1533/4-5			
1533PR/5A	26,00	1	015330016
1533/5A			

1534/...

separators

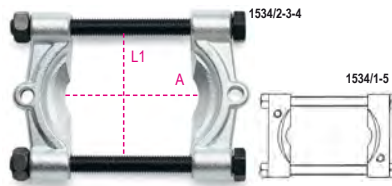

		€		
1534/1	1533/2	92,00	1	015340001
1534/2	1533/2	108,50	1	015340002
1534/3	1533/3	180,50	1	015340003
1534/4	1533/4	303,00	1	015340004
1534/5A	1533/5A	624,00	1	015340006

	A min÷Max mm	L1 mm
1534/1	5÷60	63
1534/2	12÷75	75
1534/3	22÷115	118
1534/4	25÷155	154
1534/5A	30÷220	180

1535/C...

puller kits



	€		
1535/C1	299,00	1	015350001

260x180x40 mm - 2,5 kg

	€		
1535/C2	315,00	1	015350002

	1533/2
	1533PR/1
	1534/1

260x180x40 mm - 2,8 kg

	€		
1535/C3	510,00	1	015350003

	1533/3
	1533PR/2
	1534/3

380x280x55 mm - 8,0 kg

	€		
1535/C4	790,00	1	015350004

	1533/4
	1533PR/3
	1534/4

420x380x65 mm - 14,8 kg

	€		
1535/C5A	1.205,00	1	015350006

	1533/5
	1533PR/3
	1534/5

530x510x85 mm - 27,2 kg

1539

sheet sliding hammer



1539 € 160,50 1 015390001

1540

sliding hammer

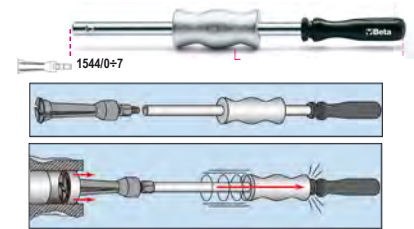

	L mm	M	1544 0÷7	€		
1540	390	M10	0÷7	90,00	1	015400001





1542/1 - 1542/2

two-leg pullers for extractors



	A	1544	€		
	min+Max	mm			
1542/1	35÷75	0÷7	77,00	1	015420001
1542/2	60÷130	9C-10C	116,50	1	015420002

	L	L1
	mm	mm
1542/1	140	140
1542/2	175	160

1544/...

internal extractors

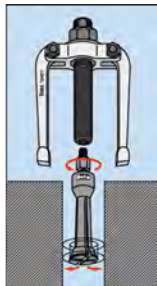

	C	mm	€		
1544/0	0,25	M10	68,50	1	015440100
A= 5÷7					
1544/A	0,80	M10	71,00	1	015440105
A= 7÷9					
1544/1	0,80	M10	73,00	1	015440110
A= 9÷12					
1544/2	1,15	M10	75,00	1	015440120
A= 13÷17					
1544/2B	1,00	M10	76,00	1	015440121
A= 14÷19					
1544/3	1,70	M10	78,00	1	015440130
A= 16÷21					
1544/4	1,65	M10	86,50	1	015440140
A= 20÷25					
1544/5	2,00	M10	93,00	1	015440150
A= 25÷30					
1544/6	3,00	M10	116,50	1	015440160
A= 30÷37					
1544/7	3,80	M10	132,50	1	015440170
A= 38÷45					
1544/9C	2,60	G 3/8"	191,50	1	015440189
A= 40÷75					
1544/10C	7,30	G 3/8"	265,00	1	015440199
A= 70÷115					

1545/C5M

puller 1542/1 with 5 extractors 1544



1545/C5M	€		
	518,00	1	015450011

1542/1	● 24 mm
1544/1	9÷12 mm
1544/2	13÷17 mm
1544/3	16÷21 mm
1544/4	20÷25 mm
1544/5	25÷30 mm

265x180x45 mm - 2,4 kg

1547/C6

dummy ball bearing extractors



1547/C6	€		
	271,00	1	015470006

420x185x60 mm - 3 kg

1547KP

set of 3 pairs of dummy ball terminals



	Ø	mm	€		
1547KP/1	9-11-12,5		42,50	1	015470106
1547KP/2	5-6-8		28,00	1	015470206

1547P

hexagonal extensions



	L	mm	1547/1	€		
1547P/1	205			9,10	1	015470101
1547P/2	102		1547/2	5,80	1	015470201

1547PC/2

round extensions, short series



	L	mm	1547/2	€		
1547PC/2	42			4,65	1	015470203

1547PL/2

round extensions, long series



	L	mm	1547/2	€		
1547PL/2	106			5,25	1	015470203

1549

kit for removing and installing double effect shock absorbers with gas return

allows stem to be kept straightened while springs are being installed



1549	€		
	368,00	1	015490001

310x270x110 mm - 3 kg



1550U

pneumatic shock absorber removal tool for cars, SUVs and commercial vehicles

CE

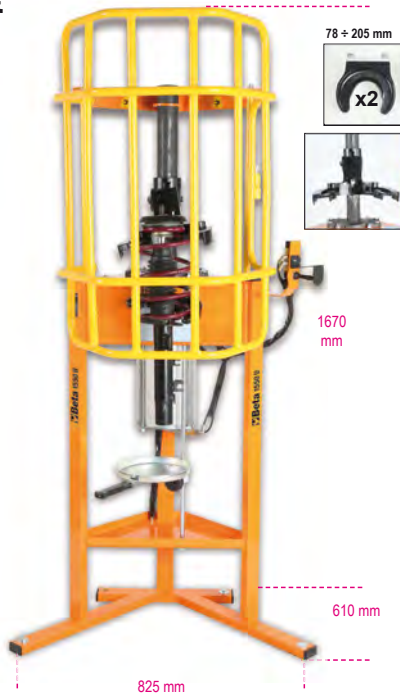

Features

- Maximum thrust: 2 tons (10 bars) - 1.6 tons (8 bars) - 1.2 tons (6 bars)
- Spring compression stroke: 335 mm
- Upper universal hold system that allows all left/right-hand spring diameters to be compressed with one upper adaptable plate
- Active safety system on spring: safety hook and 3 locking valves allow spring to be properly positioned/seated, maintaining such position throughout compression
- If spring is not positioned properly, system will stop machine.
- Protective "Full Body" Grille: provides maximum safety and working area coverage
- Control Lever operation: increased accuracy and sensitivity during compression stage
- Working position: working height on rear fork raised up to 875 mm
- Supplied with 2 lower forks for diameters 78-205 mm

1550U € 2.820,00 1 015500010

1550U/CGS-R

lowered upper jaws, pair, for item 1550U



1550U CGS-R € 539,00 1 015500035

1550U/MRC-ABE

special forks for item 1550U, specially designed for Mercedes A-B-E Class cars



1550U/MRC-ABE € 556,00 1 015500031

1550U/MRC-C

special forks for item 1550U, specially designed for Mercedes C class cars



1550U/MRC-C € 489,00 1 015500032

1550U/S...

lower fork for item 1550U



	∅ mm	€	1	015500014
1550U/S 130	78÷130 mm	353,00	1	015500014
1550U/S 182	105÷182 mm	353,00	1	015500015
1550U/S 205	125÷205 mm	353,00	1	015500016

1550U/SS187

left-hand fork for item 1550U

Particularly suitable for left-hand springs, e.g. Nissan Qashqai and Renault Koleos



1550U/SS 187 € 353,00 1 015500018

1550U/M

vice for shock absorber removal tool item 1550U

Allows shock absorber stem to be locked



1550U/M € 335,00 1 015500021

1551/C20

kit for removing shock absorber heads

Kit contents:

- 7 hexagon sockets, sizes: 16 - 17 - 18 - 19 - 21 - 22 - 24
- 1 socket extension, length: 120 mm
- 3 slotted female bits, sizes: 8x5 - 8x6 - 11x8
- 1 female hexagon bit, size: 10 mm
- 1 male XZN(R) bit, size: M10
- 1 male Torx(R) bit, size: T50
- 4 male hexagon bits, sizes: 5- 6 - 7 - 8
- 1 bit holder extension, length: 95 mm
- 1 bit holder extension, length: 190 mm



∅ 8 - 21 mm

1551/C20 € 148,00 1 015510020

320x245x71 mm - 2,6 kg

1552/C9

kit for spreading shock absorber, wishbone and steering wheel joints apart

working with single or double retractor head also makes it possible to work on double joints, e.g. from VAG group



∅ 13 mm

1552/C9 € 117,00 1 015520020

195x140x40 mm - 1,0 kg



1555/Q

compressor for MacPherson and equivalent shock absorber springs

Maximum thrust: 1500 kg

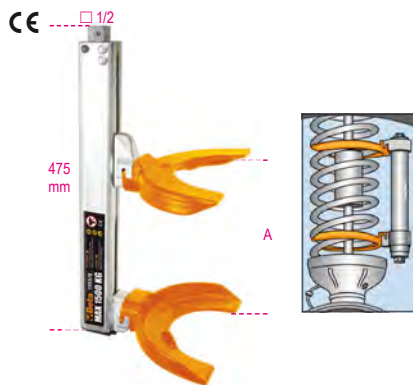

A	Ø	€	1	015550006
min+Max mm	min+Max mm			
65÷354	80÷195	766,00		

1555/QS

compressor for MacPherson and equivalent shock absorber springs



A	Ø	€	1	015550005
min+Max mm	min+Max mm			
70÷300	80÷200	943,00		

1555S/BMW-RNT

fork for BMW E39, E46 and Renault Mégane II shock absorbers, for items 1555Q and 1555/QS



1555S/BMW-RNT	€	1	015550303
	296,00		

1555C

telescopic compressor for shock absorber springs with 4 forks and torsion bar



A	Ø	N	t	€	1	015550202
min+Max mm	min+Max mm					
80÷225	90÷160	25000	8,5	909,00		

1556/1A

compressor for shock absorber springs

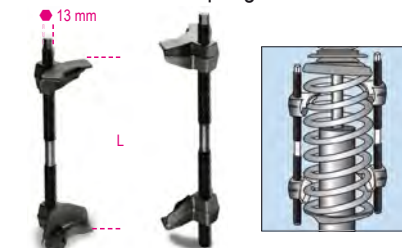

min L	Max	€	1	015560101
mm	mm			
65÷320		221,00		

1556/2A

compressor for shock absorber springs

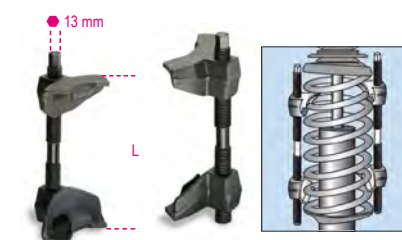

min L	Max	€	1	015560102
mm	mm			
65÷200		218,00		

1557

impact sockets for truck leaf springs



L	L1	€	1	015570137
mm	mm			
37	28	82,00		
46	34	84,00		
56	34	91,00		

1557V

impact sockets for Volvo leaf springs



mm	€	1	015570299
27	43,00		

1557/S3

set of 3 sockets for shock absorber nuts

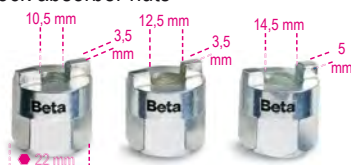

1557/S3	€	1	015570010
	64,00		

1558/C4

internal and external snap ring tool, screw-operated

square drive allows a high force to be applied in both operating conditions

Supplied tips:
Ø 2.5-3-3.5 mm



1558/C4	5,5 ÷ 77	5,5 ÷ 77	€	1	015580100
			156,00		

330x220x50 mm - 900 g

1558P

snap ring tips, pair, for item 1558



Ø	mm	€	1	015580125
2,5		6,80		
3,0		6,80		
3,5		6,80		

1558/C13

internal and external snap ring tool, screw-operated

square drive allows a high force to be applied in both operating conditions

supplied tips:

- straight: Ø 2.5 - 3 - 3.5 - 3.8 mm
- 45°: Ø 2.5 - 3 - 3.5 - 3.8 mm
- 90°: Ø 2.5 - 3 - 3.5 - 3.8 mm



1558/C13	5,5 ÷ 77	5,5 ÷ 77	€	1	015580200
			209,00		

330x220x45 mm - 1,6 kg

1559

ball joint puller, light series



	A Max mm	Ø mm	€		
1559/22	50	18÷22	81,50	1	015590001
1559/36	90	36	375,00	1	015590036
1559/45	115	45	562,00	1	015590045

1559V/8T

hydraulic screw for ball joint pullers 1559/36 and 1559/45



Nm	t	€		
80000	8	283,00	1	015590145

1560/2

ball joint pullers, professional type



	A min÷Max mm	Ø mm	€		
1560/2	60÷85	20	174,50	1	015600002

1560A

ball joint puller



	€		
1560A	234,00	1	015600601

1561/...

ball joint pullers



	L mm	A mm	Ø mm	€		
1561/1	39	36,6	18	63,50	1	015610001
1561/2	47	45,7	25	83,00	1	015610002
1561/3	63	62	30	120,50	1	015610003
1561/4	75	63	40	153,00	1	015610004

1562D

ball joint puller

Supplied with 2 screws for pulling suspension and steering joints



A max mm	Ø mm	● mm	L mm	€		
50	39	26	155	318,00	1	015620239

1563/C4

set of 4 ball joint removal sockets

for use with air hammer
set contents:

- 1 socket M12x1.25 mm
- 1 socket M12x1.5 mm
- 1 socket M14x1.5 mm
- 1 socket M16x1.5 mm



22/24 mm

	€		
1563/C4	45,50	1	015630010

1565/1-2-3

fork separators for ball joints



	Ø mm	L1 mm	€		
1565/1	18	65	72,50	1	015650001
1565/2	23	65	81,50	1	015650002
1565/3	30	88	85,00	1	015650003

1566N

tool for removing/installing steering arms



Ø x L mm	○ mm	□ mm	€		
28÷35 x 400	27	127	115,50	1	015660005
35÷45 x 190	27	-	115,50	1	015660008
35÷45 x 400	27	127	129,50	1	015660010

1566/G01

homokinetic joint puller

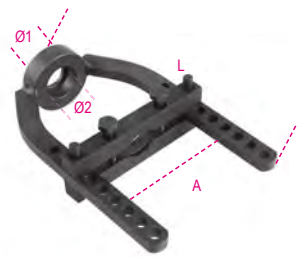

L mm	A mm	Ø1 mm	Ø2 mm	€		
250	115	29	36	137,00	1	015660052

1566P

ribbed axle shaft
circlip pliers

Pliers compress circlip, making it easier to fix axle shaft into homokinetic joint



L mm	A Max mm	€		
280	36	62,50	1	015660091

1567

lever for removing wishbone heads
and shock absorbers from pillar

Can be used by one operator



A mm	B min÷Max mm	€		
1060	100÷300	315,00	1	015670001

1568

pneumatic assembly tool
for silicone axle shaft boots

8 spreader arms
maximum arm spreading: 145 mm

CE



L mm	L1 mm	€		
420	195	225,00	1	015680001

1569/A

assortment of tools for removing and installing rear axle silent blocks, driving shaft oil seals and wheel bearings

- Bushings can be used both on vehicle and on hydraulic press
- Kit contents:
4 threaded bars: M10-M12-M14-M16
4 washers
bushings for diameters ranging from 44 mm to 82 mm



1569/A € 966,00 1 015690011

530x415x115 mm

1569/B

assortment of tools for removing and installing silent blocks, oil seals and wheel bearings

diameter: 14÷32 mm



1569/B € 756,00 1 015690015

1569/F

tool assortment for removing and inserting Fiat Panda, Fiat 500 and Ford Ka silentblocks



1569/F € 415,00 1 015690021

1569CP

striking tools for installing conical bearings and oil seals

Quick adjustment



	Ø min+Max mm	L mm	€		
1569CP/50	9,5÷50	130	123,50	1	015690750
1569CP/90	18÷90	145	153,00	1	015690790

1570/3

hydraulic presses for pullers



t	L mm	L1 mm	• mm	€		
30	243	36	19	226,00	1	015700003

1580/8I

two-leg hydraulic puller

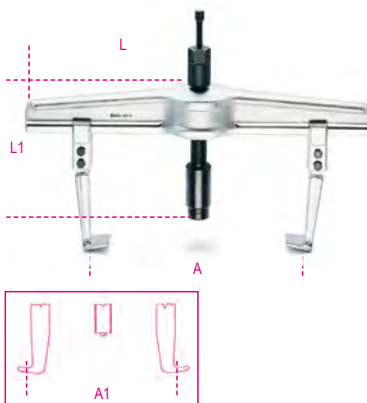

1580/8I € 1.455,00 1 015800008

	A min+Max mm	L mm	L1 mm	A1 min+Max mm	N Max
1580/8I	170÷640	715	280	260÷715	180000

1580GL

loose legs, long series, for pullers item 1580/8I



	L mm	€		
1580GL/8A	300	164,50	1	015800227
1580GL/8B	400	182,50	1	015800228
1580GL/8C	500	233,00	1	015800229

1585/5I - 6I - 7I

three-leg pullers for hydraulic use

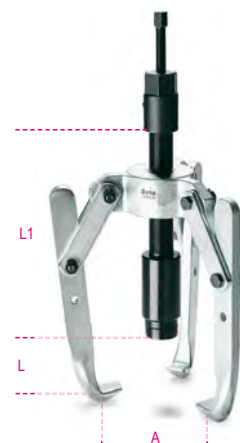

	€		
1585/5I	1.010,00	1	015850005
1585/6I	1.062,00	1	015850006
1585/7I	1.091,00	1	015850007

	A min+Max mm	L1 mm	L mm	N Max
1585/5I	50÷350	135	280	150000
1585/6I	50÷350	235	280	150000
1585/7I	50÷350	335	280	150000

1585GI/5 - 6 - 7

legs for hydraulic puller
1585/I-1585/6I-1585/7I

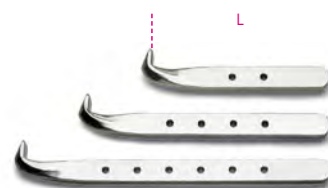

	L mm	€		
1585GI/5	135	92,00	1	015850205
1585GI/6	235	108,50	1	015850206
1585GI/7	335	132,00	1	015850207

1589VI

hydraulic screw for pullers
1580/8I and 1585/5I - 1585/6I - 1585/7I



1589VI € 595,00 1 015890001

1589PI/50 - 100 - 150

extension sockets for hydraulic screw



	L mm	L1 mm	€		
1589PI/50	50	70	54,00	1	015890005
1589PI/100	100	120	59,50	1	015890010
1589PI/150	150	170	65,00	1	015890015

1590 standard clamps



A max mm	L1 mm	€	🔧	📄
60	55	24,70	2	015900305
80	65	32,00	2	015900307
100	65	40,00	2	015900310
120	85	45,50	2	015900312
150	95	66,00	2	015900315

1591 screw clamps

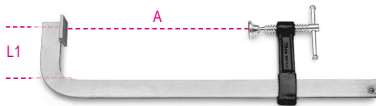

A ~	A max mm	L1 mm	€	🔧	📄
200	200	80	26,00	2	015910020
300	310	85	32,50	2	015910030
400	410	85	34,50	2	015910040
500	500	95	46,50	2	015910050
600	600	95	47,50	2	015910060
800	800	95	57,50	2	015910080
1000	1000	110	72,50	2	015910100

1593 screw clamps

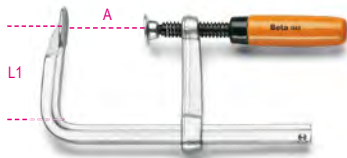

A ~	A max mm	L1 mm	€	🔧	📄
160	170	80	31,50	2	015930016
200	240	100	47,50	2	015930020
300	320	145	66,50	2	015930030

1594 lever bar clamps

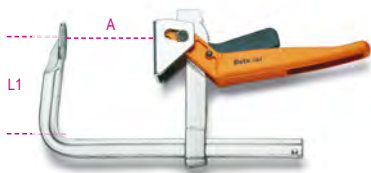

A ~	A max mm	L1 mm	€	🔧	📄
200	240	145	103,50	1	015940020
250	290	145	107,50	1	015940025
300	340	145	115,50	1	015940030
400	430	150	120,50	1	015940040
500	530	150	126,50	1	015940050
600	630	150	133,00	1	015940060

1595 screw clamps

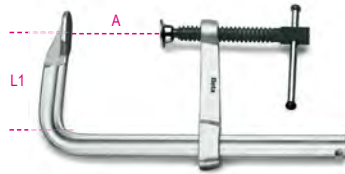

A ~	A max mm	L1 mm	€	🔧	📄
200	230	100	49,50	2	015950020
250	270	120	54,00	2	015950025
300	330	120	68,50	2	015950030
400	420	120	77,00	2	015950040
500	520	125	83,50	2	015950050
600	620	125	88,50	2	015950060
800	820	125	105,00	1	015950080
1000	1030	125	116,50	1	015950100

1599F parallel bench vices

with hardened top and slides



L1 mm	BxH mm	Ø mm	A MAX mm	€	🔧	📄
100	92x46	11	125	310,00	1	015990100
125	108x54	13	150	395,00	1	015990125
150	125x62	13	200	556,00	1	015990150
175	140x70	15	220	758,00	1	015990175

1599P parallel bench vices

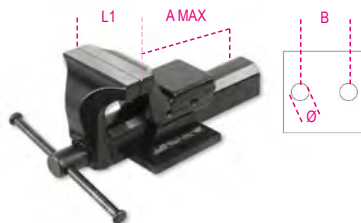

L1 mm	B mm	Ø mm	A MAX mm	€	🔧	📄
100	92	11	111	272,00	1	015990000
125	108	13	130	327,00	1	015990025
150	130	15	170	455,00	1	015990050

1599B revolving bases for vices item 1599P



• 1599B	1599P	€	🔧	📄
100	100	113,50	1	015990810
125	125	129,00	1	015990812
150	150	160,00	1	015990815

1599T parallel drill vices

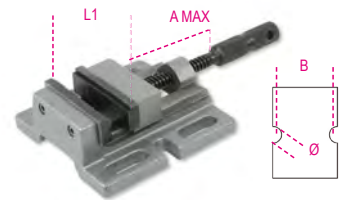

L1 mm	B mm	Ø mm	A MAX mm	€	🔧	📄
80	111	11	65	153,50	1	015990480
100	120	13	87	190,50	1	015990500

1599G pairs of aluminium jaw covers

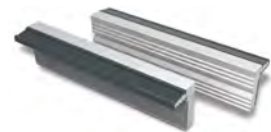

A mm	€	🔧	📄
100	50,00	1	015990910
125	52,00	1	015990912
150	56,50	1	015990915
180	63,00	1	015990917

1600Q 8 four-way wrench for control panel operators

square 5 / 6 / 7-8 mm
triangle 7 / 9 mm
flaps 3-5 mm
hexagon 1/4"
slotted head 1.0x7 mm + cross head PH2



L mm	€	🔧	📄
76	27,50	1	016000008

1600Q 10 eight-way wrench with articulated joint, for control panel operators

square 5 / 6-7 / 8-9 mm
triangle 5-6-7 / 8-9 / 10 mm
flaps 3-5 mm
hexagon 1/4"
male drive 1/4"



L mm	€	🔧	📄
125	35,00	1	016000010

CRIMPING PLIERS FOR TERMINALS AND TERMINALS

		Terminals	Die cavity	Range (mm ²)	Use
1601/PC					For telephone and data transmission terminals 4P/6P/8P
1602				0,75-6	For insulated terminals, light series
1602A				0-6	For insulated terminals, standard model
1603				1,25-5,5	For non-insulated terminals, light series
1603A				0-8	For non-insulated closed terminals, standard model
1603B				0-8	For non-insulated open terminals, standard model
1606/2				0,14-10	Heavy-duty, for cylindrical terminals
1606A				0,5-6 6-16	For cylindrical terminals
1606T				0,1-10	For cylindrical terminals, 4-sided crimping
1607				6,48 5,41 1,69	Heavy-duty, for BNC coaxial wires RG 58, RG 59, RG 62, RG 71
1608				0,5-6	For insulated terminals, with pressure regulator
1608A				0,75-6	Heavy-duty, for insulated terminals
1609				0,5-2,5	For non-insulated terminals
1609A				0,5-6	Heavy-duty, for non-insulated terminals
1609B				10-120	For non-insulated terminals



1601/PC

ratchet crimping pliers for telephone terminals and data transmission

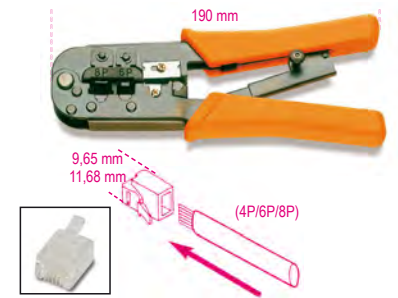

RJ11-RJ12-RJ45

€ 59,50

2 016010011

1602

crimping pliers for insulated terminals, light series

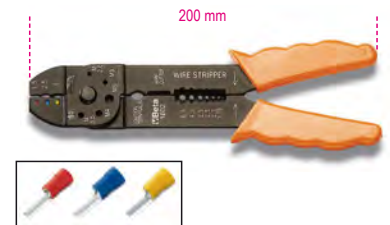

mm²
0,75+6

€ 14,80

5 016020001

1602/C9

crimping pliers, light series, with assortment of 450 terminals



1602/C9

€ 127,50

1 016020045

1602

BM00180 R/6,3
BM00280 B/6,3
BM00380 G/6,3
BM00191 R/6,3
BM00291 B/6,3
BM00392 G/6,3
BM00160 R/1,6
BM00260 B/2,3
BM00360 G/3,6

n.
1
50
50
50
50
50
50
50
50
50

420x350x35 mm - 1,5 kg

1602A

crimping pliers for insulated terminals, standard model

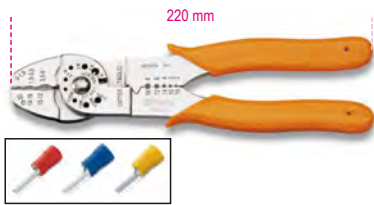

$\frac{mm^2}{0-6}$ € 54,00 2 016020005

1603

crimping pliers for non-insulated terminals, light series

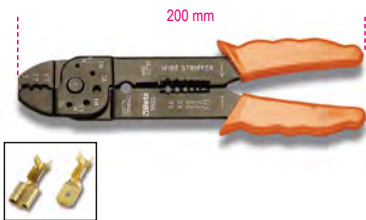

$\frac{mm^2}{1,25-5,5}$ € 14,80 5 016030001

1603A

crimping pliers for non-insulated closed terminals, standard model

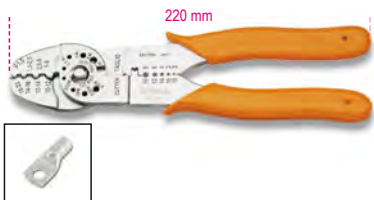

$\frac{mm^2}{0-8}$ € 54,00 2 016030005

1603B

crimping pliers for non-insulated open terminals, standard model

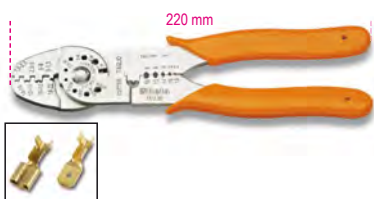

$\frac{mm^2}{0-8}$ € 55,50 2 016030010



1606/2

heavy duty crimping pliers for cylindrical terminals



$\frac{mm^2}{0,14-10}$ L mm 175 A mm 65 B mm 20 € 324,00 1 016060002

1606A

crimping pliers for tubular terminals



$\frac{mm^2}{1606A6}{0,5-6}$ € 86,50 1 016060010
 $\frac{mm^2}{1606A16}{6-16}$ € 86,50 1 016060016

1606A/C9

crimping pliers for tubular terminals with assortment of 450 terminals, 0,5-6 mm²



1606A/C9 € 142,50 1 016060045

Code	Terminal	n.
1606A6		1
BM00601	W/0,5	50
BM00604	N/1,5	100
BM00506	B/2,5	100
BM00508	G/4	100
BM00610	Y/6	100

420x350x35 mm - 2,5 kg



Beta

1606T

crimping pliers for tubular terminals, 4-sided crimping

reduced lever stress



$\frac{mm^2}{0,1-10}$ L mm 173 A mm 61 B mm 13 € 289,00 1 016060005

1607

heavy duty crimping pliers for BNC coaxial wires RG 58, RG 59, RG 62, RG 71



1607 L mm 220 A mm 73 B mm 19 € 284,00 1 016070001

1608

crimping pliers for insulated terminals, with pressure regulator



$\frac{mm^2}{0,5-6}$ € 111,00 1 016080001

1608/C9

pliers
with assortment of 450 terminals



1608/C9 € 223,50 1 016080045

	n.
1608	1
BM00180 R/6,3	50
BM00280 B/6,3	50
BM00380 G/6,3	50
BM00191 R/6,3	50
BM00291 B/6,3	50
BM00392 G/6,3	50
BM00160 R/1,6	50
BM00260 B/2,3	50
BM00360 G/3,6	50

420x350x35 mm - 2 kg

1608A

heavy duty crimping pliers
for insulated terminals



mm²
0,75÷6 € 225,00 1 016080005

1609

crimping pliers for non-insulated
terminals, professional model
fast performance



mm²
0,5÷2,5 € 111,00 1 016090001

1609A

heavy duty crimping pliers
for non-insulated terminals



mm²
0,5÷6 € 437,00 1 016090005

1609B

crimping pliers for noninsulated terminals

punch crimps,
10 mm² ÷ 120 mm²



L
mm mm²
600 10÷120 € 296,00 1 016090101

1609C/C5

oil-pressure crimping pliers
with 5 pairs of dies

hexagonal crimps,
25 mm² ÷ 240 mm²



mm²
50÷240 € 1.895,00 1 016090210

500x300x110 mm - 4 kg

1609M

dies for item 1609C

hexagonal crimps



	mm ²	€		
1609M/16	10-16	67,00	1	016090221
1609M/35	25-35	67,00	1	016090223
1609M/70	50-70	67,00	1	016090225
1609M/120	95-120	67,00	1	016090227
1609M/150	150	67,00	1	016090229
1609M/185	185	67,00	1	016090231
1609M/240	240	67,00	1	016090233

1639S

nylon wire puller

with interchangeable heads



L
m m
10 4 € 19,50 1 016390010

1640K

oil-pressure punching machine with 4 punches

round punches
22.5-25.5-32.5-55.5 mm



€ 1.650,00 1 016400001

470x400x100 mm

1640

sheet metal punch press



€ 1.067,00 1 016400100

1640A

adapter for item 1640



€ 11,90 1 016400080



1640P

threaded pin for item 1640



	∅ mm	€		
1640P/9	9,5	35,50	1	016400088
1640P/19	19	41,00	1	016400089

1640Q

square punches for item 1640



	mm	€		
1640Q 45	45x45	709,00	1	016400065

1640T

round punches for item 1640

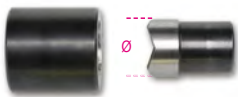

	∅ mm	€		
1640T 22,5	22,5	67,50	1	016400022
1640T 25,5	25,5	88,50	1	016400025
1640T 32,5	32,5	106,50	1	016400032
1640T 55,5	55,5	136,00	1	016400055

CERTIFICATION SERVICE FOR MEASURING INSTRUMENTS

Certification of measuring instruments is essential in the sectors or fields of application where precise, unambiguous, recognizable measurements are required.

Certification involves issuing an Accredia certificate:

On request, Beta Utensili S.p.A. provides the certification service for Sliding Gauges, Digital Verniers, Dial Indicators, Micrometers and Feeler Gauges. To receive this service, please contact your dealer.



1650

sliding gauge
reading to 0.05 mm

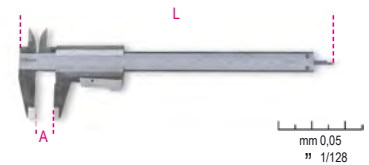

UNI EN ISO 13385-1DIN 862

A max mm	L mm	€		
150	235	59,00	1	016500001
200	290	77,50	1	016500002

1650FD

sliding gauge for brake discs
reading to 0.1 mm

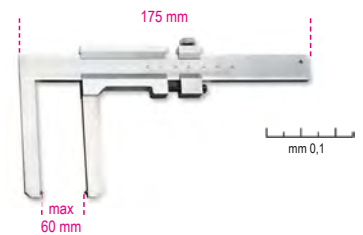

	€		
1650FD	203,00	1	016500050

1650FT

sliding gauge for brake drums
made from stainless steel
reading to 0.05 mm

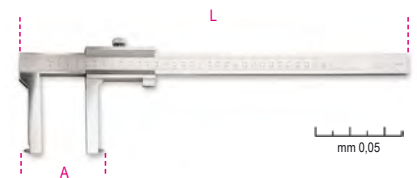

	A max mm	L mm	€		
1650FT/1	350	438	380,00	1	016500060
1650FT/2	500	550	664,00	1	016500070

1651DGT

digital vernier
reading to 0.01 mm

- Reading to 0.01 mm
- Screw slider locking
- mm/inch conversion



UNI EN ISO 13385-1DIN 862CE

A Max mm	L mm	€		
150	225	121,50	1	016510111
200	285	143,00	1	016510112

Beta

1651DGT/IP

digital vernier,
reading to 0.01 mm, degree of protection IP67

Total protection against dust and liquids; it also works when it is completely immersed.

CE



UNI EN ISO 13385-1 DIN 862CE

1651DGT/IP € 288,00 1 016510611

270x115x35 mm - 450 g

1652

analogue vernier,
analogue reading to 0.02 mm



UNI EN ISO 13385-1DIN 862

1652 € 123,00 1 016520016

1654

workshop verniers,
reading to 0.02 mm



UNI EN ISO 13385-1DIN 862

A max mm	L mm	€	1	016540020
200	330	269,00	1	016540020
300	410	365,00	1	016540030

1654DGT

digital vernier,
reading to 0.01 mm
reading to 0.0005"

CE

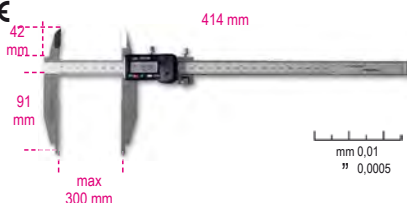

UNI EN ISO 13385-1DIN 862CE

1654DGT € 616,00 1 016540111

1656

depth gauge, reading to 0.02 mm



UNI EN ISO 13385-2DIN 862

A max mm	L mm	€	1	016560020
200	260	127,50	1	016560020
300	360	187,50	1	016560030

1657DGT/2

digital depth gauge
reading to 0.01 mm
reading to 0,0005"

CE



UNI EN ISO 13385-2DIN 862CE

A max mm	L mm	€	1	016570002
200	270	237,50	1	016570002

1658/...

outside micrometers,
reading to 0.01 mm



DIN 863/II

A mm	€	1	016580025
1658/25 0÷25	73,50	1	016580025
1658/50 25÷50	79,50	1	016580050
1658/75 50÷75	90,00	1	016580075
1658/100 75÷100	98,50	1	016580100

Beta

1658/C4

assortment of 4 micrometers
item 1658



DIN 863

1658/C4 € 295,00 1 016580001

1658/25 0÷25 mm

1658/50 25÷50 mm

1658/75 50÷75 mm

1658/100 75÷100 mm

365x245x35 mm - 2,5 kg

1658DGT

outside micrometers,
reading to 0.001 mm

CE



DIN 863CE

A mm	€	1	016580325
1658DGT25 0÷25	332,00	1	016580325
1658DGT50 25÷50	379,00	1	016580350

1658SP/1

base for micrometer



1658SP/1 € 51,00 1 016580910

Beta

1659

thickness gauge with dial indicator, reading to 0.01 mm

C=dial field



C	mm	€	Weight	Code
1659	0÷10	188,50	1	016590001

1662/1 - 1662/2

dial indicator, reading to 0.01 mm

C=dial field



DIN	C	mm	€	Weight	Code
DIN 878	1662/1	0÷5	86,00	1	016620001
	1662/2	0÷10	105,50	1	016620010

1662DGT/A

digital dial indicator, reading to 0.01 mm

C = Dial field



C	mm	€	Weight	Code
1662DGT/A	0-12,5	262,00	1	016620311

1662AN

adjustable stylus dial indicator, reading to 0.01 mm

C=Dial field



DIN	C	mm	€	Weight	Code
DIN 2270	1662AN	0÷0,8	204,50	1	016620200

1662SP0

magnetic base



Code	€	Weight	Code
1662SP0	73,00	1	016620800

1662SP2

magnetic base, rotating



Code	€	Weight	Code
1662SP2	132,00	1	016620910

1666

precision squares made from stainless steel ground and lapped



DIN	L	L1	mm	mm	€	Weight	Code
DIN 875/0	100	70	59,50	1	016660210		
	150	100	86,00	1	016660215		
	200	130	103,50	1	016660220		
	250	165	134,00	1	016660225		
	300	200	168,50	1	016660230		

1666A

flanged precision squares made from stainless steel ground and lapped



DIN	L	L1	mm	mm	€	Weight	Code
DIN 875/0	100	70	87,00	1	016660110		
	150	100	118,00	1	016660115		
	200	130	166,00	1	016660120		
	250	170	206,50	1	016660125		
	300	200	262,00	1	016660130		

1668

squares made from normalized, ground steel



DIN	L	L1	mm	mm	€	Weight	Code
DIN 875/2	100	70	26,50	2	016680210		
	150	100	35,50	2	016680215		
	200	130	45,50	2	016680220		
	250	165	66,00	1	016680225		
	300	174	81,50	1	016680230		

1668A

flanged precision squares made from normalised, ground steel



DIN	L	L1	mm	mm	€	Weight	Code
DIN 875/2	100	70	31,50	2	016680110		
	150	100	48,00	2	016680115		
	200	130	61,00	2	016680120		
	250	165	88,00	1	016680125		
	300	176	105,50	1	016680130		

1670

squares
made from ground steel



L mm	L1 mm	€	🔧	📦
100	70	16,40	3	016700010
150	100	17,00	3	016700015
200	130	19,20	3	016700020
250	160	21,00	3	016700025
300	175	23,30	3	016700030
400	230	35,00	2	016700040
500	280	38,50	2	016700050
600	330	41,00	2	016700060
800	420	55,50	1	016700080
1000	500	66,00	1	016700099

1670A

flanged precision squares
made from ground steel



L mm	L1 mm	€	🔧	📦
100	70	21,50	3	016700110
150	100	23,30	3	016700115
200	130	25,50	3	016700120
250	165	30,50	3	016700125
300	175	36,00	3	016700130
400	230	46,50	2	016700140
500	280	62,50	2	016700150
600	330	70,00	2	016700160
800	420	83,50	1	016700180
1000	500	103,50	1	016700199

1672

mitre square, adjustable sliding blade,
base and blade made from steel

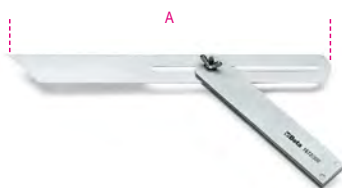

A mm	€	🔧	📦
300	50,00	2	016720030

1672A

mitre square, adjustable,
sliding blade, aluminium base,
blades made from chrome-plated steel

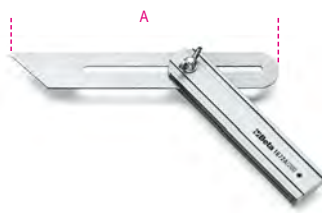

A mm	€	🔧	📦
200	26,00	3	016720120
300	28,50	3	016720130

1674A

carpenter's squares blades
made from stainless steel,
with aluminium bases, double metric scale



L mm	L1 mm	€	🔧	📦
300	169	24,70	2	016740130
400	214	31,00	2	016740140

1676

protractors made from stainless steel

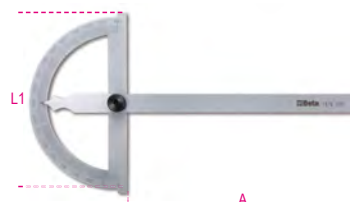

A mm	A mm	L1 mm	G mm	€	🔧	📦
120	120	80	1°	39,00	2	016760012
150	165	120	1°	45,00	2	016760015
200	210	150	1°	54,00	2	016760020
300	310	200	1°	73,00	1	016760030

1678/C3

bevel protractor
made from stainless steel



L Max mm	D mm	€	🔧	📦
300	70	277,00	1	016780030

1679

universal gauge with contact-roll,
made from stainless steel,
reading to 0.1 mm

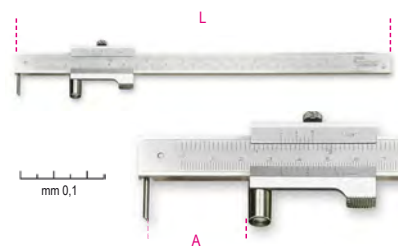

L mm	A Max mm	€	🔧	📦
235	200	84,00	1	016790020

1679/PR

spare tip for universal gauge 1679



1679/PR	€	🔧	📦
	13,50	1	016790021

1680

trammels, hardened steel body
and tips

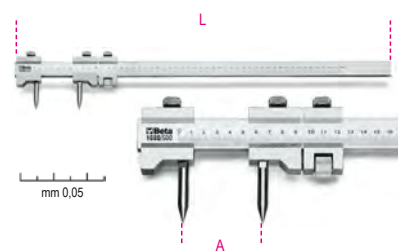

L mm	A Max mm	€	🔧	📦
660	500	277,00	1	016800050

1680A

inside callipers

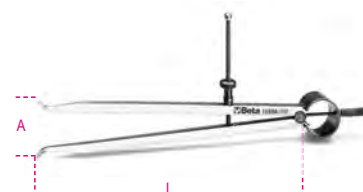

L mm	A Max mm	€	🔧	📦
150	144	18,10	2	016800115
200	200	22,20	2	016800120
250	245	27,50	1	016800125
300	300	31,50	1	016800130



1680B

outside callipers



L mm	A Max mm	€	📦	🚚
150	155	18,10	2	016800215
200	190	22,20	2	016800220
250	235	27,50	1	016800225
300	280	31,50	1	016800230

1680C

precision dividers,
hardened steel straight tips



L mm	A Max mm	€	📦	🚚
150	138	18,10	2	016800315
200	190	22,20	2	016800320
250	235	27,50	1	016800325
300	280	31,50	1	016800330

1682

flexible graduated rules
made from stainless steel



L mm	H mm	±	€	📦	🚚
150	13	0,5	2,89	5	016820015
200	13	0,5	3,15	5	016820020
250	13	0,5	3,90	5	016820025
300	13	0,5	4,85	5	016820030
500	13	0,5	10,90	2	016820050
1000	13	0,5	28,50	2	016820100

1683

semi-rigid graduated rules
made from stainless steel

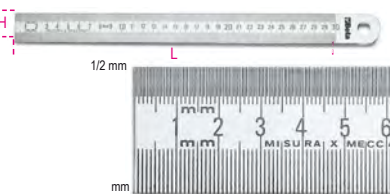

L mm	H mm	±	€	📦	🚚
300	30	1	8,55	5	016830030
500	30	1	14,40	2	016830050
1000	30	1	36,00	2	016830100
1500	30	1	80,50	1	016830150

1685/C7

assortment of 7 measuring and marking tools



1685/C7	€	📦	🚚
	284,00	1	016850110

	1650	160 mm
	1658/25	0+25 mm
	1670	100 mm
	1680C	150 mm
	1682	150 mm
	1688BC	165 mm
	1688BC/R	

320x210x37 mm - 1,2 kg

1687A

engineer's precision scribe,
tip bent at 90°, with handle

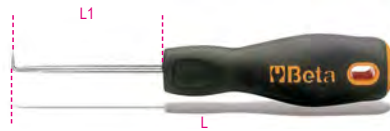

1687A	L mm	L1 mm	€	📦	🚚
	153	80	6,10	1	016870120

1687AC

engineer's precision scribe,
short tip bent at 90°, with handle



1687AC	L mm	L1 mm	€	📦	🚚
	153	80	6,10	1	016870125

1687D

engineer's precision scribe,
straight tip, with handle



1687D	L mm	L1 mm	€	📦	🚚
	153	80	6,10	1	016870110

1687U

engineer's precision scribe,
hook tip, with handle



1687U	L mm	L1 mm	€	📦	🚚
	153	80	6,10	1	016870115

1687/S4

set of 4 engineer's precision scribes,
with handles



1687/S4	€	📦	🚚
1687A-1687AC 1687D-1687U	24,40	1	016870150

1688

engineer's scribe
made from hardened steel



1688	L mm	Ø mm	€	📦	🚚
	250	2	8,05	5	016880020

1688A

engineer's scribe
made from hardened steel



1688A	L mm	Ø mm	€	📦	🚚
	200	4	14,60	5	016880120

1688PC

engineer's scribe
made of chrome-plated, hardened steel



1688PC	L mm	Ø mm	€	📦	🚚
	150	1	35,00	1	016880300

1688PC/R

spare tip for item 1688PC



1688PC/R	€	📦	🚚
	10,10	1	016880310

1688M

carpenter's pencil



	L mm	€	50	016880880
1688M	180	1,05		

1690F

folding ruler made of fibreglass
precision class III



	L m	S mm	€	5	016900220
1690F/2	2	17	11,40		

1690L

folding ruler made of birch
precision class III



	L m	S mm	€	5	016900200
1690L/2	2	17	12,50		

1691BM

measuring tapes
shock-resistant bimaterial ABS casings,
steel tapes,
precision class: II

CE



	L m	S mm	€	1	016910205
1691BM/5	5	25	15,00		
1691BM/8	8	32	22,50		
1691BM/10	10	32	27,50		

1692

measuring tapes,
shock-resistant bi-material ABS casings,
steel tapes,
precision class II

CE



	L m	S mm	€	5	016920052
1692/2	2	16	7,30		
1692/3	3	16	9,10		
1692/5	5	19	12,90		
1692/8	8	25	18,70		

1693

laser distance meter,
20 m

MEASUREMENTS:

- single distance measurement
- continuous measurement or minimal measurement

Auto off feature

Battery life: up to 4,000 measurements



CE
IP54

Technical Data:

- Measurement range: 0.05 ÷ 20m (0.2ft÷ 66ft)
- Scale selection: m, in, ft
- Measurement accuracy: ±1.5 mm (± 0.06 in)
- Laser class: 2
- Battery life: AAA 2 x 1.5V

	H mm	L mm	S mm	€	1	016930020
1693 20	100	36	23	115,50		

1693M

laser distance meter, multipurpose,
80 m

MEASUREMENTS:

- single distance measurement
- continuous measurement or minimal measurement

FUNCTIONS:

- addition/subtraction
- area measurement
- volume measurement
- indirect measurement (Pythagorean measurement)
- tilt measurement

Auto off feature

Soft cloth case (included)

Battery life: up to 4,000 measurements



CE
IP54

Technical data:

- Measurement range: 0.05 ÷ 80 m (0.2 in ÷ 229ft)
- Scale selection: m, in, ft
- Measurement accuracy: ±1.5 mm (± 0.06 in)
- Laser class: 2
- Max. storage: 99 units
- Batteries: AAA 2 x 1.5V

	H mm	L mm	S mm	€	1	016930080
1693M 80	115	48	29	195,50		

1694/L

measuring tapes shock-resistant
ABS casings, PVC-coated fibreglass tapes,
precision class III

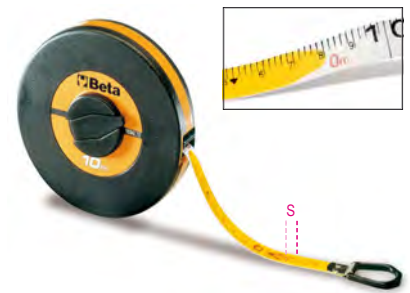

	L m	S mm	€	1	016940110
1694L10	10	13	12,10		
1694L20	20	13	15,00		

1694A/L

measuring tapes with handles,
shock-resistant ABS casings,
PVC-coated fibreglass tapes,
precision class III



	L m	S mm	€	1	016940230
1694A/L30	30	13	30,00		
1694A/L50	50	13	39,00		

1694B/L

measuring tape with handle,
aluminium casing, varnished steel tape,
precision class II



	L m	S mm	€	1	016940350
1694B/L50	50	12,5	60,00		

Beta

1695XS

pocket spirit level with magnetic V-shaped base
made from profiled aluminium
2 unbreakable vials
accuracy: 1mm/m



L mm	H mm	S mm	€	🔧	📦
70	48,5	20	12,30	5	016950250

1696

spirit levels made from anodized profile aluminium, with 2 unbreakable vials,
accuracy: 1 mm/m



L mm	H mm	S mm	€	🔧	📦
200	50	19	20,70	2	016960002
400	50	19	23,90	2	016960004
500	50	19	26,00	2	016960005
600	50	19	28,00	2	016960006
800	50	19	35,00	2	016960008
1000	50	19	38,50	2	016960010

1696A

spirit levels made from die-cast aluminium, with 1 ground base and 2 unbreakable vials, accuracy: 1 mm/m



L mm	H mm	S mm	€	🔧	📦
300	43	23	29,50	2	016960103
400	43	23	31,50	2	016960104
500	43	23	34,50	2	016960105
600	43	23	37,00	2	016960106
800	43	23	60,00	2	016960108
1000	43	23	75,50	1	016960110

1696B

spirit levels with magnetic bases
made from anodized profiled aluminium,
2 unbreakable vials accuracy: 1 mm/m



L mm	H mm	S mm	€	🔧	📦
200	49	22	32,00	2	016960202
300	49	22	33,50	2	016960203
400	49	22	35,50	2	016960204
500	49	22	43,00	2	016960205
600	49	22	45,00	2	016960206

1696D

spirit levels made of die-cast aluminium with handles,
4 ground bases and 3 unbreakable vials,
accuracy: 1 mm/m



L mm	H mm	S mm	€	🔧	📦
300	47	25	28,00	2	016960353
400	47	25	31,50	2	016960354
500	47	25	34,50	2	016960355
600	47	25	38,50	2	016960356

1696S

levelling staffs made from aluminium, with 2 unbreakable vials



L mm	H mm	S mm	€	🔧	📦
1500	90	25	98,50	1	016960415
2000	90	25	117,00	1	016960420
2500	90	25	146,00	1	016960425
3000	90	25	165,50	1	016960430

1697

cross laser level,
30 metres, green beam,
with magnetic base and wall-mount bracket,
in case

TECHNICAL SPECIFICATIONS:

- self-levelling cross
- self-levelling function can be switched off for manual use
- laser diode 515 Nm, class 2
- working range: 30 m
- accuracy: ± 1 mm at 5 m
- self-levelling range: $3^\circ \pm 0.5^\circ$

- body made of ABS and nonslip rubber
- 1/4" female drive
- 2xAA batteries
- battery life: 4 hours

BASE:

- 1 magnetic base for individual and combined use, 1/4" male drive
- 1 adjustable tightening bracket for several wood and metal profiles (for use in combination with magnetic base)
- quick horizontal and vertical alignment at a 90° angle

CE



H mm	L mm	S mm	€	🔧	📦
82	57	89,5	244,00	1	016970030

320x230x90 mm

IP55

1699L

precision surface level made from die-cast iron with ground prismatic base, 2 unbreakable vials,
accuracy: 0.05 mm/m



DIN 877

1699L	L mm	A mm	€	🔧	📦
	200	49	295,00	1	016990002

1699L/1

precision surface level made from die-cast iron with ground prismatic base, 2 unbreakable vials,
accuracy: 0.02 mm/m



DIN 877

1699L/1	L mm	A mm	€	🔧	📦
	200	49	314,00	1	016990005

1699Q

precision square levels made from die-cast iron with 2 prismatic bases and 2 ground flat bases, 2 unbreakable vials,
accuracy: 0.05 mm/m



DIN 877

L mm	A mm	€	🔧	📦
150	40	418,00	1	016990015
200	48	523,00	1	016990020

1700N

masonry points



L mm	S mm	€	🔧	📦
250	16	15,20	5	017000005
300	16	16,50	5	017000006

1700N/PM
masonry points
with hand guards



L mm	S mm	€	🔧	📦
250	16	20,50	2	017000105
300	16	23,70	2	017000106

1701N
masonry chisels



L mm	A mm	S mm	€	🔧	📦
250	23	16	16,40	5	017010001
300	23	16	17,60	5	017010003

1701N/PM
masonry chisels
with hand guards



L mm	A mm	S mm	€	🔧	📦
250	23	16	21,20	2	017010101
300	23	16	23,70	2	017010103

1701PMR
hand guards for items 1700N and 1701N



D mm	L mm	€	🔧	📦
16	115	9,85	1	017010206

1701NE/...
electrician's chisels



	SxL mm	€	🔧	📦
1701NE3	10x200	10,10	5	017010406
1701NE4	10x250	10,70	5	017010409

1702N
extra-wide chisels



A mm	SxH mm	€	🔧	📦
50	13x23	21,40	2	017020005
70	13x23	21,90	2	017020007

1702N/PM
extra-wide chisels
with hand guards



A mm	SxH mm	€	🔧	📦
50	13x23	26,00	2	017020105
70	13x23	28,50	2	017020107



We recommend frequent cooling of the tool while regrinding it.

1702PMR
hand guard for item 1702N



L mm	€	🔧	📦
115	7,60	1	017020200

1704
carpenter's wrenching bars



L mm	6 mm	mm	mm	€	🔧	📦
500	16	35	28	27,50	2	017040050
600	16	34	26	31,00	2	017040060
800	18	38	29	44,00	2	017040080

1704A
crow bars with open and pointed edges

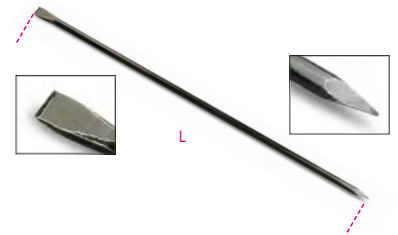

L mm	6 mm	mm	€	🔧	📦
1500	25	45	76,50	1	017040110
2000	28	55	109,00	1	017040120

1704C
crow bars with closed and pointed edges



L mm	8 mm	min-MAX mm	mm	€	🔧	📦
1200	21-31	39	94,00	1	017040210	
1400	31-37	42	112,50	1	017040212	
1600	25-37	42	139,50	1	017040215	

1705
chalk line reel made from aluminium



L m	€	🔧	📦
1705 30	18,40	4	017050001

1705PT
chalk powder



g	€	🔧	📦
250	11,80	5	017050025

1706DGT

digital depth gauge for tyre threads



1706DGT € 35,00 1 017060011

1707

screw pitch gauge

For ISO 60° metric and Whitworth 55° threads



P (ISO) 0,25÷6 W 62÷4x1" € 16,50 5 017070001

1707A/1 - 2 - 3

radius gauges, concave and convex steel blades



	R mm	L mm	n	€		
1707A/1	1,0÷7,0	70	34	25,50	2	017070007
1707A/2	7,5÷15	85	32	27,50	2	017070015
1707A/3	15,5÷25	85	30	27,50	2	017070025

1708/8 - 13 - 20

metric feeler gauges



	S	€		
1708/8	S = 0,05÷0,50 mm	6,25	5	017080008
1708/13	S = 0,05÷1,00 mm	7,05	5	017080013
1708/20	S = 0,05÷1,00 mm	11,40	5	017080020

1709/10 - 1709/18

nut splitters



	L mm	A max mm	€		
1709/10	90	17 (M10)	50,00	1	017090010
1709/18	108	25 (M16)	55,50	1	017090018

1710

hydraulic nut splitters



C min mm	C max mm	€		
7 (M4)	22 (M14)	229,00	1	017100001

1712E/1 - 2 - 3

flexible magnetic pick up tools

F = magnetic power



	L mm	D mm	F kg	€		
1712E/1	420	7,5	0,5	29,50	2	017120011
1712E/2	530	15	1,8	37,00	2	017120012
1712E/3	532	19	3,0	46,00	2	017120013

1712TF

telescopic magnet with flexible head

• With washer jet cleaner
F = magnetic force



L mm	D mm	F kg	€		
150÷590	11	1	19,60	1	017120600

1713M

flexible pick up tools

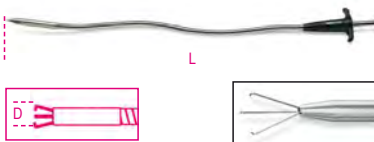

L mm	D mm	€		
500	7	41,00	2	017130011
1000	7	72,50	1	017130015

1714

inspection mirror made from plastic



	L mm	D mm	€		
1714	155	25	3,60	5	017140001

1715

telescopic joint inspection mirror
chrome-plated metal body



	L mm	D mm	€		
1715	180÷540	30	31,00	1	017150001

1715FL/A

square flexible inspection mirror



	L mm	A mm	B mm	€		
1715FL/A	600	53	90	36,50	1	017150110

1715R/FL

kit of 2 inspection mirrors for items 1715FL/A and 1715FL/B

	€		
1715R/FL	7,80	1	017150151

1715FL/B

rectangular flexible inspection mirror
with light

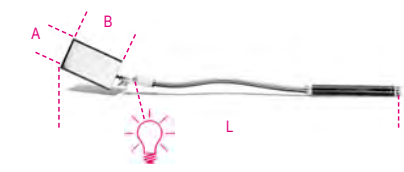

	L mm	A mm	B mm	€		
1715FL/B	553	53	90	44,50	1	017150115

1715B/R5L

kit of 5 spare light bulbs for item 1715FL/B

	€		
1715B/R5L	6,35	1	017150152

1716A

angled bit for general use



	L mm	L1 mm	D mm	€		
1716A	240	125	6	10,60	3	017160040

1716P

packing scraper



	L mm	L1 mm	D mm	€		
1716P	250	125	6	13,00	3	017160020

1716Q

square bit reamer



	L mm	L1 mm	Ø mm	€	🔧	📦
1716Q	215	100	6	9,10	5	017160010

1716R

round bit reamer



	L mm	L1 mm	Ø mm	€	🔧	📦
1716R	215	100	6	9,10	5	017160001

1716U

hook bit for general use



	L mm	L1 mm	Ø mm	€	🔧	📦
1716U	195	80	6	10,60	3	017160025

1717A

scrapers, two cutting edges



	L mm	L1 mm	L2 mm	€	🔧	📦
150	70	260	20,10	2	017170015	
200	75	310	21,40	2	017170020	
250	100	360	23,70	2	017170025	

1717B

scrapers, three cutting edges



	L mm	L1 mm	L2 mm	€	🔧	📦
150	75	260	17,30	2	017170115	
200	85	310	20,20	2	017170120	
250	100	360	22,50	2	017170125	

1717C

flat scrapers, varnished



	L mm	S mm	L1 mm	€	🔧	📦
150	18	270	17,10	2	017170215	
200	20	320	19,20	2	017170220	
250	25	370	21,50	2	017170225	

1717D

flat scraper, front cut



	L mm	S mm	L1 mm	€	🔧	📦
1717D 150	150	23	240	23,30	2	017170320

1717T

triangular blade scrapers, complete with 2 blades



	L mm	€	🔧	📦
1717T	310	10,90	1	017170610

1717T RT

spare triangular blades



	L mm	€	🔧	📦
1717T RT	65	2,27	1	017170660

1717T RS

spare shaped blades



	€	🔧	📦
1717T RS	2,27	1	017170661

1717V

paint scrapers, blades can be used on several sides



	L mm	A mm	€	🔧	📦
1717V 38	200	38	7,40	1	017170703
1717V 65	285	65	15,70	1	017170706

1717V R

spare blades for item 1717V



	L mm	€	🔧	📦
1717V R38	38	2,27	1	017170753
1717V R65	65	3,25	1	017170756

CUTS OF ENGINEER'S FILES

Rough

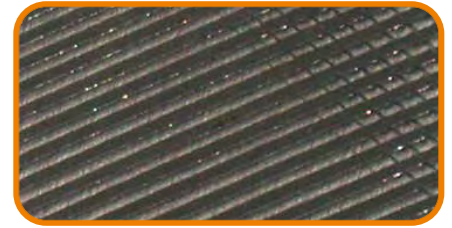

Second-cut

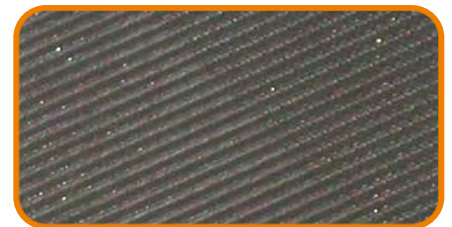

Smooth



1718D...Q

rough square files, without handles



	L mm	L "	€	🔧	📦
1718D6/Q	150	6	8,65	5	017180121
1718D8/Q	200	8	10,40	5	017180131
1718D10/Q	250	10	14,00	5	017180141

1718A...Q

second-cut square files, without handles



	L mm	L "	€	🔧	📦
1718A6/Q	150	6	8,85	5	017180021
1718A8/Q	200	8	10,70	5	017180031
1718A10/Q	250	10	14,70	5	017180041

1718D...T

rough triangular files, without handles



	L mm	L "	€	🔧	📦
1718D6/T	150	6	10,50	5	017180123
1718D8/T	200	8	13,30	5	017180133
1718D10/T	250	10	17,50	5	017180143

1718A...T

second-cut triangular files, without handles

	L mm	L "	€	5	017180023
1718A6/T	150	6	10,70	5	017180023
1718A8/T	200	8	13,60	5	017180033
1718A10/T	250	10	18,40	5	017180043

1718D...P

rough flat files, without handles

	L mm	L "	€	5	017180125
1718D6/P	150	6	8,20	5	017180125
1718D8/P	200	8	9,65	5	017180135
1718D10/P	250	10	12,90	5	017180145

1718A...P

second-cut flat files, without handles

	L mm	L "	€	5	017180025
1718A6/P	150	6	8,65	5	017180025
1718A8/P	200	8	10,00	5	017180035
1718A10/P	250	10	14,00	5	017180045

1718D...M

rough half-round files, without handles

	L mm	L "	€	5	017180127
1718D6/M	150	6	11,50	5	017180127
1718D8/M	200	8	14,10	5	017180137
1718D10/M	250	10	18,40	5	017180147

1718A...M

rough half-round files, without handles

	L mm	L "	€	5	017180027
1718A6/M	150	6	11,70	5	017180027
1718A8/M	200	8	14,50	5	017180037
1718A10/M	250	10	19,30	5	017180047

1718D...R

rough round files, without handles

	L mm	L "	€	5	017180129
1718D6/R	150	6	8,20	5	017180129
1718D8/R	200	8	9,65	5	017180139
1718D10/R	250	10	12,70	5	017180149

1718A...R

second-cut round files, without handles

	L mm	L "	€	5	017180029
1718A6/R	150	6	8,65	5	017180029
1718A8/R	200	8	10,00	5	017180039
1718A10/R	250	10	13,40	5	017180049

1718D...S5

set of 5 rough files, without handles



	L mm	L "	€	1	017180130
1718D6/S5	150	6	47,00	1	017180130
1718D8/S5	200	8	57,00	1	017180140
1718D10/S5	250	10	75,50	1	017180150

1718A...S5

set of 5 second-cut files, without handles



	L mm	L "	€	1	017180030
1718A6/S5	150	6	48,50	1	017180030
1718A8/S5	200	8	59,00	1	017180040
1718A10/S5	250	10	80,00	1	017180050

1719BMD...Q

rough square files, with handles

	L mm	L "	€	5	017190191
1719BMD6/Q	150	6	11,90	5	017190191
1719BMD8/Q	200	8	13,10	5	017190221
1719BMD10/Q	250	10	18,00	5	017190241
1719BMD12/Q	300	12	23,30	3	017190325

1719BMA...Q

second-cut square files, with handles

	L mm	L "	€	5	017190021
1719BMA6/Q	150	6	12,00	5	017190021
1719BMA8/Q	200	8	14,30	5	017190052
1719BMA10/Q	250	10	18,70	5	017190071
1719BMA12/Q	300	12	27,50	3	017190311

1719BMX...Q

smooth square files, with handles

	L mm	L "	€	5	017190022
1719BMX6/Q	150	6	12,80	5	017190022
1719BMX8/Q	200	8	16,50	5	017190053
1719BMX10/Q	250	10	22,30	5	017190072

1719BMD...T

rough triangular files, with handles

	L mm	L "	€	5	017190193
1719BMD6/T	150	6	14,10	5	017190193
1719BMD8/T	200	8	16,20	5	017190223
1719BMD10/T	250	10	21,80	5	017190243
1719BMD12/T	300	12	31,00	3	017190326

1719BMA...T

second-cut triangular files, with handles

	L mm	L "	€	5	017190023
1719BMA6/T	150	6	14,10	5	017190023
1719BMA8/T	200	8	17,50	5	017190054
1719BMA10/T	250	10	22,70	5	017190073
1719BMA12/T	300	12	32,50	3	017190313

1719BMX...T

smooth triangular files, with handles

	L mm	L "	€	5	017190024
1719BMX6/T	150	6	16,80	5	017190024
1719BMX8/T	200	8	21,80	5	017190055
1719BMX10/T	250	10	28,00	5	017190074

1719BMD...P

rough flat files, with handles

	L mm	L "	€	5	017190195
1719BMD6/P	150	6	11,90	5	017190195
1719BMD8/P	200	8	12,50	5	017190225
1719BMD10/P	250	10	17,60	5	017190245
1719BMD12/P	300	12	22,90	3	017190327

1719BMA...P

second-cut flat files, with handles



	L mm	L''	€	📦	💻
1719BMA6/P	150	6	12,50	5	017190025
1719BMA8/P	200	8	14,10	5	017190056
1719BMA10/P	250	10	18,30	5	017190075
1719BMA12/P	300	12	26,00	3	017190315

1719BMX...P

smooth flat files, with handles



	L mm	L''	€	📦	💻
1719BMX6/P	150	6	12,80	5	017190026
1719BMX8/P	200	8	16,80	5	017190057
1719BMX10/P	250	10	21,80	5	017190076

1719BMD...M

rough half-round files, with handles



	L mm	L''	€	📦	💻
1719BMD6/M	150	6	15,50	5	017190197
1719BMD8/M	200	8	16,80	5	017190227
1719BMD10/M	250	10	22,50	5	017190247
1719BMD12/M	300	12	31,50	3	017190328

1719BMA...M

second-cut half-round files, with handles



	L mm	L''	€	📦	💻
1719BMA6/M	150	6	16,20	5	017190027
1719BMA8/M	200	8	18,90	5	017190058
1719BMA10/M	250	10	24,20	5	017190077
1719BMA12/M	300	12	35,00	3	017190317

1719BMX...M

smooth half-round files, with handles



	L mm	L''	€	📦	💻
1719BMX6/M	150	6	17,20	5	017190028
1719BMX8/M	200	8	21,30	5	017190059
1719BMX10/M	250	10	29,50	5	017190078

1719BMD...R

rough round files, with handles



	L mm	L''	€	📦	💻
1719BMD6/R	150	6	11,90	5	017190199
1719BMD8/R	200	8	12,30	5	017190229
1719BMD10/R	250	10	17,10	5	017190249
1719BMD12/R	300	12	22,60	3	017190329

1719BMA...R

second-cut round files, with handles



	L mm	L''	€	📦	💻
1719BMA6/R	150	6	12,60	5	017190029
1719BMA8/R	200	8	13,90	5	017190060
1719BMA10/R	250	10	17,80	5	017190079
1719BMA12/R	300	12	23,80	3	017190319

1719BMX...R

smooth round files, with handles



	L mm	L''	€	📦	💻
1719BMX6/R	150	6	14,50	5	017190031
1719BMX8/R	200	8	16,20	5	017190061
1719BMX10/R	250	10	21,80	5	017190081

1719BMA...B5

set of 5 second-cut files, with handles, in wallet



	L mm	L''	€	📦	💻
1719BMA8/B5	200	8	78,50	1	017190297
1719BMA10/B5	250	10	101,50	1	017190298

1719BMD...B5

set of 5 rough files, with handles, in wallet



	L mm	L''	€	📦	💻
1719BMD8/B5	200	8	71,00	1	017190303
1719BMD10/B5	250	10	97,00	1	017190305

1719BMD...S5

set of 5 rough files, with handles

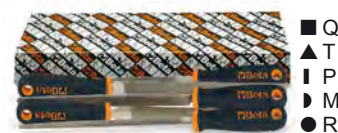

	L mm	L''	€	📦	💻
1719BMD6/S5	150	6	65,50	1	017190200
1719BMD8/S5	200	8	71,00	1	017190230
1719BMD10/S5	250	10	97,00	1	017190250
1719BMD12/S5	300	12	131,50	1	017190363

1719BMA...S5

set of 5 second-cut files, with handles



	L mm	L''	€	📦	💻
1719BMA6/S5	150	6	67,50	1	017190030
1719BMA8/S5	200	8	78,50	1	017190070
1719BMA10/S5	250	10	101,50	1	017190080
1719BMA12/S5	300	12	145,00	1	017190361

1719BMX...S5

set of 5 smooth files, with handles



	L mm	L''	€	📦	💻
1719BMX6/S5	150	6	74,00	1	017190032
1719BMX8/S5	200	8	92,50	1	017190069
1719BMX10/S5	250	10	123,50	1	017190082

1719BMB/P

universal cut flat files, plastic handles



	L mm	L''	€	📦	💻
1719BMB/P250	250	10	28,00	5	017190152
1719BMB/P300	300	12	33,00	5	017190153



1719BMC

half-round and flat files,
plastic handles

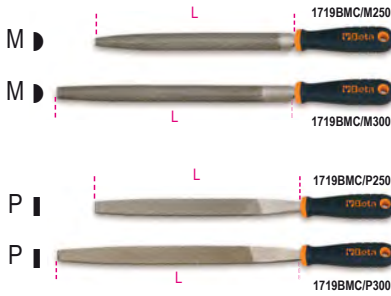

UNI 5569 - UNI 5568

	L mm	L "	€	📦	🏠
1719BMC/M 250	250	10	18,70	6	017190252
1719BMC/M 300	300	12	23,20	4	017190253
1719BMC/P 250	250	10	14,80	6	017190262
1719BMC/P 300	300	12	18,30	4	017190263

1719BM/RR

round rasp,
plastic handle



	L mm	L "	€	📦	🏠
1719BM/RR	200	8	15,40	5	017190351

1719BM/RL

flat rasp file,
plastic handle



	L mm	L "	€	📦	🏠
1719BM/RL	200	8	14,80	5	017190360

1719BMR

handles for files



	L mm	A mm	€	📦	🏠
1719BMR/0	95	25	3,40	10	017190950
1719BMR/0B	110	29	3,40	10	017190955
1719BMR/1	110	29	3,40	10	017190951
1719BMR/1B	110	29	3,40	10	017190953
1719BMR/2	123	31	3,40	10	017190952
1719BMR/2B	123	31	3,40	10	017190954

	mm	"	📦	🏠
1719BMR/0	100/150	4/6	▲ D	
1719BMR/0B	100/150	4/6	■ D	
1719BMR/1	150/200	6/8	▲ D	
1719BMR/1B	150/200	6/8	■ D	
1719BMR/2	250/300	10/12	▲ D	
1719BMR/2B	250/300	10/12	■ D	

1720/...

second cut needle files,
shaft Ø 3 mm

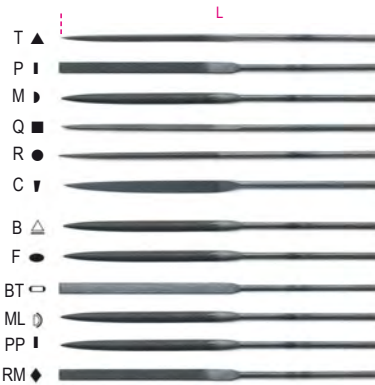

UNI 5569 UNI 5670

	L mm	€	📦	🏠
1720T	160	6,80	5	017200004
1720P	160	6,80	5	017200006
1720M	160	6,80	5	017200008
1720Q	160	6,80	5	017200009
1720R	160	6,80	5	017200010
1720C	160	6,80	5	017200012
1720B	160	6,80	5	017200005
1720ML	160	6,80	5	017200007
1720BT	160	6,80	5	017200011
1720F	160	6,80	5	017200013
1720PP	160	6,80	5	017200014
1720RM	160	6,80	5	017200015



	€	📦	🏠
1720/S3	20,40	1	017200000

1720/B

set of 6 needle files in plastic wallet



	€	📦	🏠
1720/B6	43,00	1	017200002
1720/B12	81,50	1	017200003

1720D/...

diamond needle files
grit D126



	L mm	€	📦	🏠
1720D/T	160	44,50	2	017200104
1720D/P	160	44,50	2	017200106
1720D/M	160	44,50	2	017200108
1720D/Q	160	44,50	2	017200109
1720D/R	160	44,50	2	017200110
1720D/C	160	44,50	2	017200112



	€	📦	🏠
1720D/B6	269,00	1	017200120

1721/B6

set of 6 files for ignition contacts
in plastic wallet



	€	📦	🏠
1721/B6	22,70	1	017210010

1723

spring puller



	L mm	€	📦	🏠
1723	210	14,70	5	017230001

1725

hacksaw frame



	L mm	L1 mm	€	📦	🏠
1725	420	300	20,30	4	017250001

1725CR

mini hacksaw frame



	L mm	L1 mm	€	📦	🏠
1725CR	250	150	11,00	5	017250010

1726

hacksaw frame, blade attachment
system in the handle



	L mm	L1 mm	€	📦	🏠
1726	440	300	27,00	4	017260001

1726BM

hacksaw frame with quick release blade attachment system

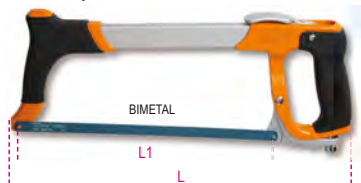

1726BM	L mm	L1 mm	€		
	400	300	44,00	1	017260050

1727

hacksaw frame, heavy series

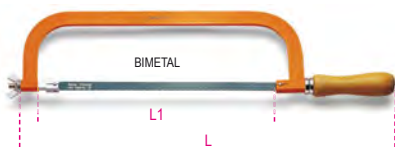

1727	L mm	L1 mm	€		
	515	300	18,60	4	017270001

1727BM

hacksaw frame, one hand grip



1727BM	L mm	L1 mm	€		
	315	300	22,50	5	017270020

1728...

blades for hacksaw frames



24x1"



1728LA	€		
1725CR			
1725MQ			
1728BM	3,35	100	017280010
1725-1726			
1727-1727M			
1728CO	4,55	50	017280030
1725-1726			
1727-1727M			

1729

fixed frame hacksaw

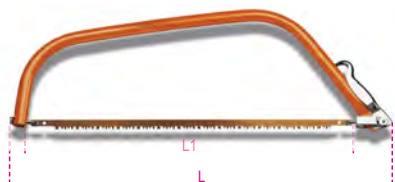

1729	L mm	L1 mm	€		
	710	610	22,20	5	017290001

1729LR

spare blade for item 1729



1729LR	€		
	5,70	10	017290010

1729CG

plasterboard saw



1729CG	L mm	L1 mm	€		
	310	160	22,20	2	017290200

1729DM 450

wood rip saw

medium tooting, 12 teeth/inch



1729DM 450	L mm	L1 mm	€		
	450	400	25,50	4	017290450

1730

universal spatulas, with stainless steel blades and handles



S mm	L mm	L1 mm	€		
38	210	85	5,60	2	017300038
63	220	95	6,70	2	017300063
75	220	95	7,30	2	017300075
100	220	95	8,40	2	017300100

1730M

mixer spatulas, with stainless steel blades and handles



L1 mm	L mm	S mm	€		
150	245	27	7,80	2	017300215
200	330	28	14,70	2	017300220
250	365	36	18,10	2	017300225

1730V 38

glazier's spatula, knife blade made from stainless steel



S mm	L mm	L1 mm	€		
38	225	100	5,60	2	017300338

1736A

file brush
stainless steel wires,
wire Ø: 0.5 mm



1736A	L mm	€		
	240	10,30	10	017360010

1737

brush, corrugated brass wires,
wire Ø: 0.2 mm



1737	L mm	€		
	145	4,95	10	017370001

1737NX

brake shoe cleaning brush, brassed steel wires,
wire Ø: 0.3 mm



1737NX	L mm	€		
	270	5,90	5	017370010

1737AC

steel wire brush,
5 rows,
wire Ø: 0.3 mm



1737AC	L mm	€		
	275	5,60	5	017370020

1737B

pairs of vehicle battery lug and post cleaner steel brushes, steel wire
wire Ø: 0.3 mm



1737B € 13,90 1 017370050

1738

bristle brush



1738 L mm 210 H mm 30 € 8,05 10 017380001

1739B

lazy tongs riveter, supplied with 5 interchangeable nozzles



max 830 mm

Ø mm	3,2	4	4,8	5	6	6,4
Aluminium	•	•	•	•	•	•
Stainless steel	•	•	•	•		

1739B € 118,00 1 017390151

1740A

heavy duty riveting pliers supplied with 5 interchangeable nozzles



525 mm

Ø mm	3,2	4	4,8	5	6	6,4
Aluminium	•	•	•	•	•	•
Stainless steel	•	•	•	•		

1740A € 107,50 1 017400101



1740B

compact heavy-duty riveting pliers, supplied with 5 interchangeable nozzles



L

Ø mm	2,4	3	3,2	3,2	4,8
Aluminium	•	•	•	•	•
Steel	•	•	•	•	•
Stainless steel	•	•	•	•	•

1740B 280 L mm 280 € 69,50 1 017400280

Ø mm	2,4	3,2	4,0	4,8	6,4
Aluminium	•	•	•	•	•
Steel	•	•	•	•	•
Stainless steel	•	•	•	•	•

1740B 330 L mm 330 € 80,50 1 017400330

1741B

riveting pliers supplied with 4 interchangeable nozzles



250 mm

Ø mm	2,4	3,2	4	4,8	5
Aluminium	•	•	•	•	•
Steel	•	•	•	•	•
Stainless steel	•	•	•		

1741B € 36,50 1 017410000

1741B/C5

riveting pliers item 1741B with assortment of 700 aluminium rivets



1741B/C5 € 113,00 1 017410025

	Ø mm	L mm	n.
1741RV2,9K	3,0	6	200
1741RV3,2K	3,2	8	200
1741RV3,8K	4,0	10	100
1741RV4K	4,0	12	100
1741RV4,8K	4,8	12	100

415x155x60 mm - 3,1 Kg

1741BP

riveting pliers supplied with 4 interchangeable nozzles



260 mm

Ø mm	2,4	3,2	4	4,8	5
Aluminium	•	•	•	•	•
Steel	•	•	•	•	•
Stainless steel	•	•	•	•	•

1741BP € 56,00 1 017410350

1741U

ultra compact riveting pliers with adjustable force
with 4 interchangeable nozzles
3 legs: enhanced rivet hold



200 mm

Ø mm	2,4	3	3,2	4	4,8
Aluminium	•	•	•	•	•
Steel	•	•	•	•	•
Stainless steel	•	•	•	•	•

1741U € 44,00 1 017410450



1741RV...K

aluminium rivets

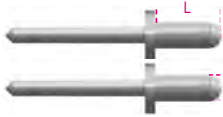

1741RV 2,9K	€ 17,60	1	017410191
ØxL = 3x6 mm			
1741RV 3,2K	€ 18,20	1	017410192
ØxL = 3,2x8 mm			
1741RV 3,8K	€ 22,70	1	017410193
ØxL = 4x10 mm			
1741RV 4K	€ 24,90	1	017410194
ØxL = 4x12 mm			
1741RV 4,8K	€ 31,00	1	017410195
ØxL = 4,8x12 mm			

The prices shown are for 500 pieces

1742

riveting pliers for threaded rivets, with 4 interchangeable mandrels (1x M3;M4;M5;M6)



1742	€ 122,00	1	017420001
------	----------	---	-----------

M	Ø mm	L mm
3	5	11
4	6	11
5	7	13
6	9	17

1742KR

spare mandrels for item 1742



M3	€ 46,00	1	017420043
M4	€ 46,00	1	017420044
M5	€ 46,00	1	017420045
M6	€ 46,00	1	017420046

1742R-AL/M...

aluminium threaded rivets for items 1742-1742A-1946KF



1742R-AL M3	€ 4,35	1	017420023
ØxL = 5x10 mm			
M = 3			
1742R-AL M4	€ 4,45	1	017420024
ØxL = 6x12 mm			
M = 4			
1742R-AL M5	€ 4,75	1	017420025
ØxL = 7x13 mm			
M = 5			
1742R-AL M6	€ 5,80	1	017420026
ØxL = 9x15 mm			
M = 6			

The prices shown are for 20 pieces

1742R-A/M...

steel threaded rivets for items 1742-1742A-1946KF



1742R-A M3	€ 4,55	1	017420013
ØxL = 5x11 mm			
M = 3			
1742R-A M4	€ 4,65	1	017420014
ØxL = 6x11 mm			
M = 4			
1742R-A M5	€ 4,95	1	017420015
ØxL = 7x13 mm			
M = 5			
1742R-A M6	€ 5,90	1	017420016
ØxL = 9x17 mm			
M = 6			
1742R-A M8	€ 5,60	1	017420018
ØxL = 11x17 mm			
M = 8			
1742R-A M10	€ 6,70	1	017420020
ØxL = 13x24 mm			
M = 10			

The prices shown are for 20 pieces
• The prices shown are for 10 pieces

1742/C4

riveting pliers item 1742 with assortment of 400 threaded steel inserts



1742/C4	€ 271,00	1	017420005
---------	----------	---	-----------

	M	Ø mm	n.
1742R-A/M3	3	5	100
1742R-A/M4	4	6	100
1742R-A/M5	5	7	100
1742R-A/M6	6	9	100

415x155x60 mm - 2,9 kg

1742A

heavy duty riveting pliers for threaded inserts, with 4 interchangeable mandrels



1742A	€ 449,00	1	017420100
-------	----------	---	-----------

M	Ø mm	L mm
5	7	13
6	9	17
8	11	17
10	13	24

1742A/KR

spare pins for item 1742A

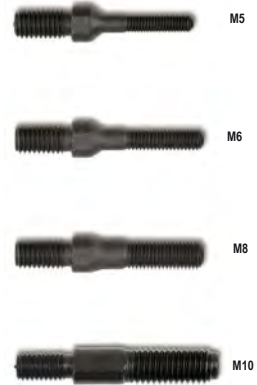

1742A/KR M5	M5	€ 31,50	1	017420143
1742A/KR M6	M6	€ 31,50	1	017420144
1742A/KR M8	M8	€ 31,50	1	017420145
1742A/KR M10	M10	€ 31,50	1	017420146

1742A/C

riveting pliers item 1742A with assortment of 60 threaded steel inserts



1742A/C	€ 487,00	1	017420105
---------	----------	---	-----------

	M	Ø mm	n.
1742R-A/M5	5	7	20
1742R-A/M6	6	9	20
1742R-A/M8	8	11	10
1742R-A/M10	10	13	10

536x310x80 mm - 2,1 kg

1743

fitting tool for nylon ties

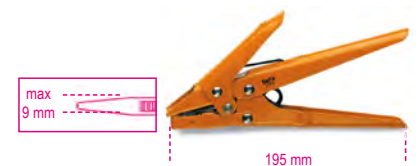

1743	€ 51,50	1	017430001
------	---------	---	-----------

1743T

cable tie cutting tool

• Also suitable for cutting small cables (3x1.5mm²; 1x17mm²)



1743T	€ 30,50	1	017430100
-------	---------	---	-----------

1749

bonding gun varnished metal sheet



	L min mm	€		
1749	340	12,90	2	017490001

1749A

bonding gun, professional model aluminium tube



	L min mm	€		
1749A	360	40,50	1	017490010

1749A/RB

spare spouts for item 1749A

	€		
1749A/RB	0,93	2	017490051

1749A/RT

front screw plugs for item 1749A

	€		
1749A/RT	2,05	1	017490052

1749AC

high thrust gun for chemical binders



	L min mm	€		
1749AC	360	36,00	1	017490005

1750

lever operated grease guns

Can be used with cartridges 1750CG or loose grease



1 g, 550 bar Max

1750CG	cc	L mm	€		
400	500	380	40,00	1	017500500
600	750	450	47,00	1	017500750

1750R/1 - 1750R/2

spare flexible hose made from nylon



	L mm	€		
1750R/1	310	6,35	2	017500030
1750R/2	410	7,05	2	017500040

1750RC

curved rigid hose



	L mm	M mm	€		
1750RC	150	10x1	5,25	2	017500050

1750RT

4-jaw grease fitting "Hydraulic" type



	M mm	€		
1750RT	10x1	4,65	5	017500110

1750RP/1 - 1750RP/2

heads for flat nozzles



	Ø mm	M mm	€		
1750RP/1	16	10x1	11,50	2	017500115
1750RP/2	22	10x1	26,00	2	017500120

1750CG

grease cartridges for item 1750



	cc	€		
400	400	14,10	18	017500140
600	600	17,60	18	017500160

1750KG10

lever-operated grease gun, 10 kg, with high-pressure hose, 2 m

complete with swivel fitting, to avoid choking hose die-cast aluminium pump body with check valve

3 different pressure levels available:

- 4 g at 275 bar
- 7 g at 206 bar
- 9 g at 137 bar



	€		
1750KG10	180,50	1	017500100

1750TA

high-pressure, self-locking 6-pin grease nozzle

Once positioned, it remains on axis and connected to nipple; it does not have to be held like common nozzles

Easy to disconnect, even when with pressurized nozzle

Thread M10x1: suitable for all types of grease guns: electric, pneumatic, manual etc.

Deformation-free up to 550 bar



	€		
1750TA	42,50	1	017500111

1750TLA

high-pressure, self-locking 6-pin grease nozzle, long version

Once positioned, it remains on axis and connected to nipple

Easy to disconnect, even with pressurized nozzle

Thread M10x1: suitable for all types of grease guns: electric, pneumatic, manual etc.

Deformation-free up to 550 bar



	€		
1750TLA	56,50	1	017500112

1750M

mini grease gun

- With micro nozzle
- Particularly suitable for pneumatic tools



	cc	D mm	L mm	€	🔧	📄
1750M	100	43	145	21,00	1	017500025

1750M3

mini grease gun, with 3 nozzles

- fitted with three interchangeable nozzles: 0.7 - 1.0 - 1.4 mm
- particularly suitable for lubricating pneumatic tools
- can be used with loose grease



	cc	Ø mm	L mm	€	🔧	📄
1750M3	85	42	160	28,00	1	017500003

1751

metal pressure oil cans flexible spout



	cc	D mm	L mm	€	🔧	📄
200	62	140	15,10	4	017510002	
300	75	140	16,40	4	017510003	
500	85	140	17,10	4	017510005	
750	100	140	18,70	2	017510007	
1000	100	140	20,30	2	017510011	

1751R

spare spout for item 1751



	cc	€	🔧	📄
200÷1000		4,55	5	017510010

1752

plastic pressure cans rigid spouts



	cc	D mm	L mm	€	🔧	📄
200	67	140	9,85	4	017520002	
300	77	140	10,60	4	017520003	
500	95	140	11,10	4	017520005	
700	95	140	11,80	2	017520007	

1752R

spare spout for item 1752



	cc	€	🔧	📄
200÷700		4,00	5	017520020

1753

plastic pressure oil cans flexible spouts



	cc	D mm	L mm	€	🔧	📄
200	65	190	10,00	4	017530002	
300	80	190	10,30	4	017530003	
500	95	190	10,60	4	017530005	
700	95	190	11,60	2	017530007	

1753R

spare spout for item 1753



	cc	€	🔧	📄
200÷700		4,10	5	017530020

1754

plastic pressure oil cans flexible plastic spouts



	cc	D mm	L mm	€	🔧	📄
150	60	130	8,95	5	017540015	
250	65	130	10,10	5	017540025	

1755

plastic oil bottles retractable spouts



	cc	L mm	A mm	€	🔧	📄
30	160	30	6,55	5	017550003	
80	170	47	7,30	5	017550008	
150	230	58	8,20	5	017550015	

1756

pen oiler



	cc	L mm	€	🔧	📄
5		140	21,30	2	017560001

1756B

pen oiler

- Operating temperature: -10°C - +60 °C

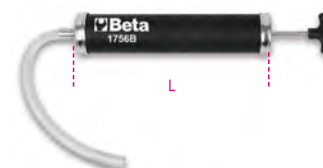

	cc	L mm	€	🔧	📄
500		280	20,70	2	017560220

1756C

suction gun, 200 ml,
made of polypropylene

- Also suitable for braking system fluid
- Double EPDM gasket
- Operating temperature: +0 - +50 °C
- NOT suitable for fuel



1756C € 32,50 1 017560502

1756D

suction gun, 1500 ml,
made of polypropylene

- Double NBR gasket
- Operating temperature: +0 - +50 °C
- NOT suitable for fuel

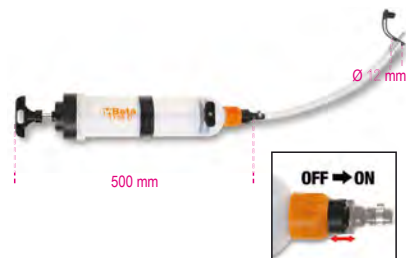

1756D € 74,00 1 017560515

1756G

diesel oil gun
capacity: 1.5 l

- Can be used to:
- fill diesel oil filters
 - fill Cerina tank



- Kit contents:**
- 2 pipes with female quick couplings for connecting diesel oil pipes
 - 2 male quick couplings, made of metal
 - 1 cone-shaped adapter for rubber pipes

1756G € 113,50 1 017560615

1756C-20R

O-rings (pair) for suction guns 1756C

1756C-20R € 4,20 1 017560503

1756D-20R

O-rings (pair) for suction guns 1756D

1756D-20R € 6,95 1 017560516

1757

battery fillers



cc	D mm	€		
250	60	3,35	4	017570002
500	75	4,00	4	017570004
1000	90	5,50	2	017570006

1757A

battery filler



1757A € 41,00 1 017570020

1758

self-adapting funnel

particularly useful for cars
with no depth in
inlet plugs



1758 € 51,00 1 017580020

1758ADB-D

non-return funnel for AdBlue®,
with straight coupling



1758 ADB-D € 33,00 1 017580050

1758ADB-45°

non-return funnel for AdBlue®,
with 45° coupling



1758 ADB-45° € 35,50 1 017580060

1758A

non-return funnel
with quick coupling, Ø 38 mm
For Volkswagen group cars



1758A € 78,00 1 017580010

1758B

non-return funnel
with quick couplings
Particularly suitable
for VAG cars



1758B € 34,50 1 017580030

1758B-RNT

non-return quick coupling
for funnel item 1758B
for Renault 1.5 dCi engine



1758B-RNT € 24,40 1 017580035

1758B/K5

kit of non-return quick coupling adapters, for funnel 1758B

Kit contents:

- 1 adapter for 1.5 dCi Renault, Dacia, Nissan engines
- 1 adapter for 1.5/1.6 dCi Renault, Dacia, Nissan engines
- 1 adapter for 3.0 BMW diesel engines
- 1 adapter for 1.5/2.0 petrol engines, VAG group
- 1 connecting adapter for funnel, with tap



1758B/K5	€ 97,00	1	017580040
----------	---------	---	-----------

1758LG

formable, rubber-covered aluminium foil, for canalizing liquids



L mm	H mm	€	1	017580006
365	168	44,00		

1758M

funnel



1758M	L mm	€	1	017580000
	350	12,80		

1758R

liquid containers

Convenient, removable, flexible spout



1758R 1	lt	€	1	017580201
1758R 2	2	9,65	1	017580202
1758R 3	3	17,00	1	017580203
1758R 5	5	20,80	1	017580205

1758VT

cylinder head testing kit

Quickly indicates whether expansion tank contains any carbon dioxide.



1758VT	€ 165,50	1	017580100
--------	----------	---	-----------

290x190x50 mm - 1 kg

1758VT/L

contrast liquid for testing cylinder heads



1758VT/L	€ 47,00	1	017580101
----------	---------	---	-----------

1759

optical analyzer for coolant, battery, windscreen and AdBlue® fluids
Supplied in a hard case

Automatic temperature compensation
Battery acid: measurement range:
1.1±1.3 kg/l
Propylene coolant: -25 °C ± -50 °C
Ethylene coolant: -25 °C ± -50 °C
Windscreen fluid: -25 °C ± -40 °C
AdBlue: Urea percent measurement: 30% ± 45%



1759	€ 153,00	1	017590251
------	----------	---	-----------

1759A

antifreeze densimeter, glass body



1759A	L mm	€	1	017590001
	340	64,50		

1759B

acid densimeter, glass body



1759B	L mm	€	1	017590005
	280	42,50		

1759HD/3

cooling system seal testing and circuit filling tools

- Make it possible to check circuit (pipes, joints, pumps, radiators) for leaks under pressure and quickly fill circuit, avoiding air bubble formation



1759HD/3	€ 539,00	1	017590063
----------	----------	---	-----------

600x500x140 mm - 6,5 kg

1759HD/RR

cooling system filling tool



1759HD/RR € 165,50 1 017590064

450x310x110 mm - 2,2 kg

1759HD/TRUCK

truck cooling system testing and sealing tool



1759HD/TRUCK € 375,00 1 017590065

440x330x100 mm - 3 kg

1759TT

kit of 4 pairs of turbo circuit testing caps, for use with tyre inflators



1759TT € 198,50 1 017590300

400x160x100 mm - 1,8 kg

CERTIFICATION SERVICE FOR ELECTRONIC INSTRUMENTS

Certification of such electronic measuring instruments as Multimeters, Amperometric Clamps, **Tachometers** and **Thermometers** is essential in the sectors or fields of application where precise, unambiguous, recognizable measurements are required.

For infrared thermometers, a 4-point calibration report (minimum, maximum and two intermediate points) with ENAC traceability is issued.

On request, Beta Utensili S.p.A. provides the certification service. To receive this service, please contact your dealer.

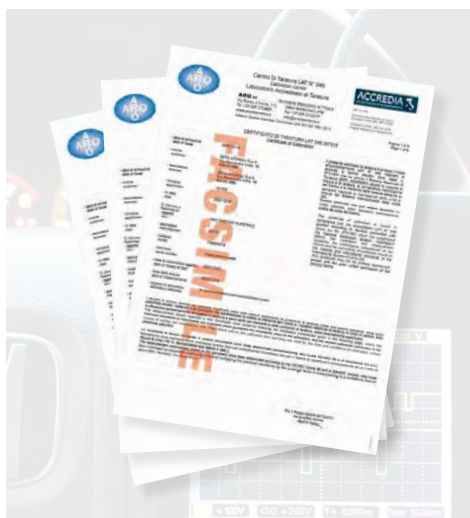

1760DGT

digital automotive multimeter



CE

195 mm



92 mm

Technical Data:

- **RPM (tachometer):**
For 2 and 4 cylinder engines
RPM4 600 - 4000 RPM
RPM4 600 - 12000 RPM (x10 RPM)
RPM2/DIS 300 - 4000 RPM
RPM2/DIS 300 - 6000 RPM (x10 RPM)
- **Dwell angle:** 4-8 CYL
- **DC voltage:** 400mV-4/40/400/1000V
- **AC voltage:** 4/40/400/700V
- **DC current:** 40/400mA-4/20A
- **AC current:** 40/400mA-4/20A
- **Resistance:** 400Ω-4/40/400kΩ-4/40MΩ
- **Capacity:** 40/400nF-4/40/100μF
- **Frequency:** 5/50/500Hz-50/500-10MHz
- **Duty cycle:** 0.1 % - 99.9%
- **Pulse amplitude:** 1 - 10ms
- **Diode test:** Test current 0.3mA
- **Continuity:** <150Ω - Test current <0.3mA
- **Display:** High-contrast, backlit 4-digit LCD
- **Overvoltage:** Category II 1000V
- **Auto power off:** 30 minutes
- **Power supply:** 1 9V battery (included)
- **Inductive clamp (included)**
- **2 tips (included)**
- **Soft cloth case (included)**
- **Operating manual**

1760DGT € 252,00 1 017600005



1760DGT/2

digital automotive multimeter, portable, with 2-channel oscilloscope and waveform generator



Kit Contents:

- Multimeter tips
- 2 BNC crocodile clips for oscilloscope
- Tip probe for oscilloscope (1X and 10X)
- Battery charger
- Nylon sheath

Technical data:

- Display: 2.8" colour TFT
- Resolution: 320 x 240 pixels
- Power supply: 100V-240V AC, 50Hz-60Hz; DC INPUT 5V DC-2A
- Battery: 2 x 2600 mAh
- Dimensions: 199 x 98 x 40 mm
- Weight: 624g

Multimeter Specifications:

- Test: Voltage, Current, Resistance, Capacity, Diodes and On-Off
- Max. voltage: 600V DC
- Max. current: 10A DC
- Max. resistance: 40MOHM
- Max. capacity: 100uF

Oscilloscope Specifications:

- Horizontal
- Bandwidth: 40MHz
- Sampling frequency range: 250MSa/s (single channel) - 125MSa/s (double channel)
- SEC/DIV range: 5ns/div ÷ 500s/div 1,2,5 sequence

Vertical

- VOLTS/DIV range: 10mV/div÷10V/divat BNC input
- Selectable analogue, bandwidth limit, typical: 20MHz
- Low frequency response (-3db): ≤10Hz a BNC
- DC Gain Accuracy: ± 3% for Normal or Medium acquisition mode, 10V/div ÷ 10 mV/div

Trigger

- Type: Edge
- Mode: Auto, Normal, Single
- Slope: Rising, Falling, Rising, & Falling
- Source: CH1, CH2

Input

- Coupling: DC, AC or GND
- Supported probe attenuation factors: 1X, 10X, 100X, 1000X

Arbitrary waveform generator

- Waveform frequency: Sine (1Hz÷25MHz), Square (1Hz÷10MHz), Ramp (1Hz÷1MHz), EXP (1Hz÷5MHz)
- Width: 2.5Vpp (50Ω) - 5Vpp (high impedance)
- Output impedance: 50Ω

Multimeter specifications:

- Test: Voltage, Current, Resistance, Capacity, Diodes and On-Off
- Max. voltage: 600V DC
- Max. current: 10A DC
- Max. resistance: 40MOHM
- Max. capacity: 100uF

1760DGT/2 € 704,00 1 017600008

1760B

digital multimeter



SPECIFICATIONS

- DC voltage: 200 mV-2/20/200/1000V
- AC voltage: 2-20/200/700V
- DC current: 2/20/200 mA-20 A
- AC current: 2/200 mA- 20 A
- Resistance: 200Ω - 2/20/200 kΩ - 2/20 MΩ
- Capacity: 2/20/200 nF - 2/200 μF
- Temperature: -20° + 1000°C/ -4 °F ~ +2000°F
- Frequency: 20kHz
- Power supply: 1 9V battery (included)

1760B € 163,50 1 017600012

1760/OHM

multimeter/megohmmeter for high voltage insulation testing. TRUE RMS indicator



- | | | |
|-------------------------|----------------------|--------------------|
| Measuring range | Base accuracy | |
| AC/DC voltage: | 50mV - 1000V | ±0.06% - ±0.1% rdg |
| AC/DC current: | 0.01μA - 10A | ±0.5% - ±1% rdg |
| Resistance: | 0.01Ω - 50MΩ | ±0.2% - ±2% rdg |
| Meg OHM: | 0.01 - 5000MΩ | ±4% rdg. max |
| Capacity: | 5nF - 10mF | ±1.5% - ±3% rdg |
| Frequency: | 50Hz - 100 MHz | ±0.02% - ±0.1% rdg |
| Temperature: | -50 °C - +1350 °C | ±0.5% rdg |
| Diode test: | 3V dc | |
| Continuity test: | <30 Ω | |

1760/OHM € 772,00 1 017600025

1760/RMS

industrial digital multimeter accurate and sturdy, in a 6-mm co-moulded shell, with antislip, shockproof outer rubber part



Technical Features:

- Measuring range Base accuracy
- AC/DC voltage 110mV - 600V ±0.8% - ±2% rdg
- AC/DC current 110μA - 10A ±1.5% - ±2% rdg
- Resistance 110Ω - 40MΩ ±1.2% - ±2.5% rdg
- Capacity 11nF - 40mF ±5% - ±10% rdg (up to 11mF)
- Frequency 1100Hz - 110 MHz ±1.2% - ±1.5% rdg
- Temperature -32°C - +1000°C ±3% - ±5% rdg
- Diode test, 3V DC ±10% rdg
- Continuity test <30 Ω -

1760/RMS € 279,00 1 017600020

1760PA/80

AC/DC amperometric clamp, 80A

Designed to measure low current leakage or absorption values on vehicles



- Range: 1mA-80A AC/DC
- Torch function with white LED
- Backlit LCD display
- Zero setting function
- Hold function
- Auto power off
- Power supply: 2 1.5V AAA-type batteries

1760PA/80 € 210,00 1 017600002



1760PA/AC

amperometric clamp and digital multi-meter

A: AC
V: AC/DC



SPECIFICATIONS

DC voltage 400 mV - 4/40/400/600 V
AC voltage 400 mV - 4/40/400/600 V
AC current 40/400/1000 A
Resistance 400Ω - 4/40/400 kΩ - 4/40 MΩ
Frequency 5/50/500 Hz - 5/50/500 kHz - 5/10 MHz
Capacity 40/400 nF - 4/40/100 μF
Temperature -20 °C ÷ 1000 °C / -4 °F ÷ 1832 °F
Power supply: 1 9V battery (included)

1760PA/AC	L mm	€	1	017600050
	190	171,00		

1760PA/AC-DC

amperometric clamp and digital multimeter

A: AC/DC
V: AC/DC



A: AC/DC
V: AC/DC

Specifications:

• DC voltage: 0.1mV ÷ 600V
• AC voltage: 0.1mV ÷ 600V
• AC current: 0.01A ÷ 1000A
• DC current: 0.01A ÷ 1000A
• Resistance: 0.1Ω ÷ 40MΩ
• Capacity: 0.001nF ÷ 40 μF
• Frequency: 0.001kHz ÷ 4kHz
• Temperature: -40°C ÷ 1000 °C
-40°F ÷ 1832°F

1760PA/AC-DC	€	1	017600000
	312,00		

1760DGT-R3

spare leads for digital multimeters and amperometric clamps



1760DGT-R3	€	1	017600603
	21,80		

1760/RSE

signal detector

Allows power supply of parts to be tested, including common rail electro-injectors, petrol/LPG electro-injectors, piezoelectric injectors, flow regulating solenoid valves, EGR solenoid valves and coils



Performing **diagnosis of individual parts of electric system** only requires probe to be brought near part being tested. In systems with electromechanical/electronic parts controlled by a control unit, this tool makes it possible to check whether:

- Control unit is being supplied with power and is performing its control function
- Cables connecting control unit to part is efficient
- Part being tested has not being disconnected
- Part has not short-circuited
- Part is operating electronically

1760/RSE	€	1	017600170
	437,00		

1760/TC2

combination contact/non-contact digital tachometer



TECHNICAL DATA

- For measuring:
 - non-contact rotational speed (rpm)
 - contact rotational (rpm)
 - and linear surface speed (m/min or ft/min).
- 5-digit LCD display.
- Scale:
 - non-contact speed 2.5÷99,999 rpm
 - contact speed 0.5÷19,999 rpm
 - linear surface speed 0.05÷1,999.9 m/min.
- Frequency: 0.8 sec.
- Power supply: 4 1.5V batteries, AA size, or 6V power supply unit (not included).
- Supplied with the following:
 - adaptor for contact tip measurement;
 - male (contact) rubber tip (2 pcs.);
 - female (contact) rubber tip (1 pcs.);
 - linear measurement tape (1 pcs.);
 - reflecting tapes;
 - instruction manual;
 - plastic case.

1760/TC2	L mm	H mm	€	1	017600161
	230	74	218,00		

1760R/TC2

set of reflecting tapes for item 1760/TC2



1760R/TC2	€	1	017600561
	19,30		

1760K

non-contact AC voltage detector with LED mini-torch

Testing range: 200-1000Vac 50/60Hz
CAT III-1000V
Requires 2 AAA batteries (included)



1760K	€	1	017600140
	35,00		

1760PT

combination voltage and continuity tester,
12-690V AC/DC

Functions:

- continuity
- phase rotation
- mains testing
- LED torch

CE



IP64
CATIV
- 600V ;
CATIII -
1000V

1760PT € 140,00 1 017600150

1760/IR500

digital infrared thermometer with dual laser
aiming system

not suitable for measuring body temperature

CE



Technical Data:

- Temperature range: -50 + 500 °C (-22 + +932 °F)
- Display resolution: 0.1 °C (0.1 °F)
- Emissivity: 0.1 + 1 adjustable
- Accuracy: -50 °C + +20 °C (+/- 3 °C); 20 + 500 °C (+/-2% or 2 °C)
- Optical resolution (D:S): 12:1
- Auto power off: ca. 10 seconds
- Operating temperature: 0 °C + 50 °C
- Storage temperature: -20 °C + 60 °C
- Power supply: 1 9V battery

1760/IR500 € 150,00 1 017600350

1760/IR1000

digital infrared thermometer with dual laser
aiming system

not suitable for measuring body temperature

CE



TECHNICAL DATA

Temperature range: -50 °C + +1000 °C (-58 °F + +1832 °F)
 Display resolution: 0.1 °C (0.1 °F)
 Emissivity: 0.1 + 1 adjustable
 Accuracy: -50 °C + 20 °C (+/- 3.5 °C); 20 °C + 300 °C (+/-1% or 1 °C); 300 °C + 1000 °C (+/-1.5%)
 Optical resolution (D:S): 20:1
 Operating temperature: 0 °C + 50 °C
 Storage temperature: -10 °C + 60 °C
 Power supply: 2 1.5V (AAA type batteries)

1760/IR1000 € 248,50 1 017600400

1760/IR1600

digital infrared thermometer
with laser aiming system

not suitable for measuring body temperature

CE



TECHNICAL DATA

Range: da -50 °C to +1600 °C / -58 °F to +2912 °F
 Scale selection: °C/°F
 Accuracy: ±1.5% or ±2 °C to 20 °C
 Laser power: <1mW
 Response: 1sec
 Emissivity: 0.10-1.0 adjustable
 Distance ratio: (D:S) 50:1
 Operating temperature: 0 °C + 50 °C / 32 °F + 122 °F
 Operating humidity: 10% to 90% RH
 Backlit LCD display
 Data storage function
 Auto power off
 Power supply: 1 9V battery (included)
 Hard case with aluminium tripod
 Operating manual

1760/IR1600 mm 200 mm 115 € 693,00 1 017600461

1760TMC

infrared thermal camera

compact thermal camera for contactless
temperature measurement, suitable for
applications in building, mechanical, electric
installation and heating industries

LCD TFT display, 2", 240x320
 sensor, 32x32 pixels
 acquisition frequency 7Hz
 thermal sensitivity <347mK
 automatic acquisition of hot and cold spots
 camera for acquisition of images in BMP format (max. 100 images)
 adjustable emissivity
 power supply: 3 alkaline AAA batteries
 USB interface
 IP54
 temperature range: -20 °C + +600 °C
 infrared band: 6.5+14µm
 visible/infrared image fusion: 0.5; 1; 2m
 alarm function, selecting acceptable maximum and minimum
 temperatures

CE



1760TMC 600 € 790,00 1 017600710

1761

wire twisting pliers
with automatic return



L mm 255 € 61,00 1 017610101

1761RS/1

reversible wire twisting pliers
with automatic return



L mm 220 € 109,00 1 017610130



1762
revolving punch pliers



∅ mm 2-2,5-3
3,5-4-4,5
L mm 210
€ 28,50
2 017620001

1763
car upholstery clip pliers



1763 170 mm
€ 34,00
1 017630001

1763G/S500
500 car upholstery clips



1763G/S500 € 63,50
1 017630105

1765/C24
cases with 24 tools
for pulling out car radios



1765/C24 € 183,00
1 017650001

1766
double suction lifter



∅ max kg 50
L mm 380
120 mm
€ 114,50
2 017660001

1766A
single suction cup



∅ max kg 30
€ 29,00
2 017660005

1766/8
assortment of 8 tools
for car glass windows



1766/8 € 426,00
1 017660100

1766ER
window trim removal tool
with handle

Allows window trims to be easily removed,
with no risk of damage



1766ER € 20,80
1 017660501

1766ER/VW
low-profile window trim removal tool

particularly suitable for VAG group window trims
with reduced grip space

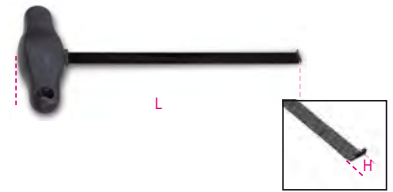

L mm 215
H mm 4
€ 14,80
1 017660510

1766L
lever for glass windows



1766L 75 mm 340 mm
€ 47,50
1 017660015

1766LI
lever for inserting car glass window cutting
cable
sharp edges for cutting bonds



1766LI 290 mm
€ 16,90
1 017660016

1766I
handle for steel cable item 1766G

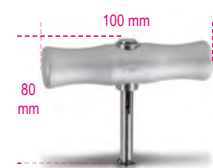

1766I 100 mm 80 mm
€ 46,00
2 017660020

1766G
steel cable for car windows

Square section



50 m 0,7 mm
€ 41,50
1 017660025

1766T

steel cable for glass windows

triangular section

0.7 mm



50 m € 47,50 1 017660026

1767A

telescopic rod

- designed to support bonnets and tailgates with decompressed pistons.
- can be used to keep pedals from moving.



L mm 640 ÷ 1090 € 65,00 1 017670000

1767B

pedal and steering wheel locking kit

the trigger adjustment mechanism ensures accurate settings when keeping the vehicle accelerated



1767B € 138,50 1 017670100

490x285x95 mm - 2,4 kg

1767PMC

magnetic tool holder, round



Ø 150 mm



1767PMC € 20,30 1 017670020

1767PMR

magnetic tool holder, rectangular

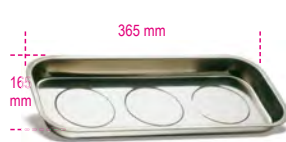

1767PMR € 41,50 1 017670010

1768

aluminium footboard

surface coated with non-slip material
maximum carrying capacity: 200 kg



L mm 960 L1 mm 300 H mm 475 € 178,50 1 017680010

1770

extra flat utility knife, 9 mm snap-off blade



1770 L mm 140 A mm 9 € 15,70 10 017700001

1770A

utility knife 9 mm with automatic blade locking mechanism, 3 blades



1770A L mm 135 A mm 9 € 5,90 10 017700025

1770RL

9 mm snap-off blades 10 pieces
for utility knives 1770, 1770BM and 1770A



1770RL € 5,25 5 017700010

1770BM

utility knife, 9 mm, 6 blades



1770BM L mm 140 A mm 9 € 12,10 10 017700050

1771

utility knife, 18 mm, supplied with 3 blades



1771 L mm 170 A mm 18 € 8,95 10 017710000

1771BM

utility knife, 18 mm, 6 spare blades



1771BM L mm 170 A mm 18 € 19,50 10 017710050

1771HD

utility knife, 18 mm, supplied with 6 blades

- automatic blade change
- screw blade locking system



1771HD L mm 190 A mm 18 € 21,90 5 017710100

1771RL

18 mm snap-off spare blades (10 pieces)
for utility knives 1771, 1771BM, 1771HD



1771RL L mm 190 A mm 18 € 7,50 5 017710010

1772M

safety utility knife with retractable blade, supplied with 3 blades

- blade retracts through an automatic spring mechanism
- die-cast alloy body
- staple remover built into handle



1772M	L mm	A mm	€	5	017720040
	170	18	17,80		

1772R

utility knife with retractable trapezoidal blade, supplied with 5 blades



1772R	L mm	A mm	€	5	017720006
	125	18	16,50		

1772H

safety utility knife with retractable blade, supplied with 2 blades



1772H	L mm	A mm	€	5	017720029
	170	18	17,30		

1772RL/2

10 long trapezoidal spare blades, in box, for utility knives, 1772H, 1772M, 1772R, 1774, 1777BMT, 1777T

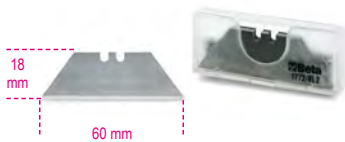

1772RL/2	€	5	017720017
	4,20		

1773A

utility knife, 25 mm



1773A	L mm	A mm	€	10	017730000
	180	25	17,30		

1773RL

25 mm blades (10 pieces) for utility knife 1773A



1773RL	€	5	017730015
	16,90		

1774

multi-function scraper with blade guard



1774	L mm	L1 mm	€	5	017740001
	155	60	4,00		

1774A

multifunction scraper, bi-material handle



1774A	L mm	A mm	€	1	017740011
	300	40	12,40		

1774A/RL

10 blades for scrapers 1774A and 1774S

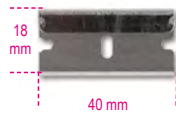

1774A/RL	€	1	017740511
	5,90		

1774S

sticker removal scrapers



1774S	A mm	L mm	€	1	017740021
	40	100	6,70		

1777BM

foldaway knife with wire stripping notch, stainless steel blade



1777BM	L mm	L1 mm	A mm	€	5	017770100
	190	80	16	11,30		

1777T

foldaway knife with trapezoidal blade, aluminium handle, 5 spare blades



1777T	L mm	A mm	L1 mm	€	5	017770030
	160	19	65	24,70		

1777BMT

foldaway knife with trapezoidal blade
4 adjustable blade depths
4; 9.5; 15.5; 21.5 mm
supplied with 3 blades

NOT AVAILABLE IN THE UK, IRELAND AND USA



1777BMT	L mm	L1 mm	A mm	€	5	017770050
	170	80	19	26,50		

1778AN

foldaway knife, stainless steel blade, lightweight anodized aluminium handle
• in case



1778AN	L mm	A mm	L1 mm	€	5	017780065
	204	26	84	30,50		

1778AX

foldaway knife, stainless steel serrated blade, aluminium handle, serration pattern for easier opening
• in case



1778AX	L mm	A mm	L1 mm	€	5	017780026
	189	26	80	33,50		

1778CM

camouflage foldaway knife,
hardened steel blade,
in case



	L mm	A mm	L1 mm	€	🔪	📦
1778CM	195	24	80	31,50	5	017780099

1778D

foldaway knife,
stainless steel blade and handle,
in case



	L mm	A mm	L1 mm	€	🔪	📦
1778D	180	22	78	32,50	5	017780060

1778M7

foldaway knife,
stainless steel mini blade,
handle with fibreglass inserts
• in case



	L mm	A mm	L1 mm	€	🔪	📦
1778M7	163	24	68	27,00	5	017780015

1778P

foldaway knife,
stainless steel and aluminium blade and
handle,
with push button opening mechanism
• in case



	L mm	A mm	L1 mm	€	🔪	📦
1778P	193	29	72	36,00	5	017780088

1778SCL

foldaway knife with soft carbon look finish,
hardened steel blade,
in case



	L mm	A mm	L1 mm	€	🔪	📦
1778SCL	180	22	78	29,50	5	017780089

1778SOS

car service knife
with window breaking hammer
and seat belt cutter features
in case



	L mm	A mm	L1 mm	€	🔪	📦
1778SOS	205	25	85	31,50	5	017780080

1778U

foldaway knife,
hardened steel blade
• in case



	L mm	A mm	L1 mm	€	🔪	📦
1778U	195	24	80	30,50	5	017780070

1778V18

foldaway knife,
aluminium handle
• in case



	L mm	A mm	L1 mm	€	🔪	📦
1778V18	195	25	85	29,50	5	017780018

1778X

knives for nautical maintenance, stainless
steel blades, aluminium handles
in case



	L mm	L1 mm	A mm	€	🔪	📦
1778X	185	85	25	28,50	2	017780050

1781

slim, long blade scissors



	L mm	€	🔪	📦
1781	132	17,40	2	017810001

1783

light duty scissors



L mm	€	🔪	📦
215	14,50	5	017830021
240	16,20	5	017830024

1784

heavy duty scissors



L mm	€	🔪	📦
175	20,80	2	017840017
200	28,00	2	017840020
250	36,50	2	017840025
300	50,00	2	017840030

1800/100

lifting airbags (max. lifting force: 100 kg)

- lifting/levelling
- locking doors



A mm	B mm	S mm	€	Icon	Icon	Code
160	150	2+55	55,50			3 018000000

1808

dual rating soldering iron with steel tips
1824R8



W	V	€	Icon	Icon	Code
20/130	230	71,00			1 018080001

1812 150

instant heat soldering iron



W	V	€	Icon	Icon	Code
150	230	101,50			1 018120015

1814M

soldering irons
with steel tips



W	V	€	Icon	Icon	Code
25	230	57,00			1 018140225
30	230	60,50			1 018140230
40	230	65,50			1 018140240

1820

soldering irons

CE



Model	Power	Length	€	Icon	Icon	Code
1820 30	30W	L = 210mm	42,50			1 018200003
1820 60	60W	L = 220mm	48,00			1 018200006
1820 80	80W	L = 260mm	68,50			1 018200008

1822

high-performance soldering irons

CE



Model	Power	Length	€	Icon	Icon	Code
1822 120	120W	LxA = 250x125 mm	104,50			1 018220012
1822 180	180W	LxA = 250x125mm	110,00			1 018220018
1822 320	320W	LxA = 250x140mm	137,00			1 018220032

1823 60

digital soldering station
supplied with soldering iron

- Temperature range: 160 °C ÷ 480 °C with ±1% accuracy.
- Memory mode designed to save the temperature selected when switching off the station.
- 3 quick selection keys (200-300-400 °C).

CE



W	€	Icon	Icon	Code
60	404,00			1 018230060

1823R/60

spare soldering iron for item 1823 60

CE



Model	Power	€	Icon	Icon	Code
1823R 60	60W	79,50			1 018230066

1824R

spare tips for soldering irons

Model	€	Icon	Icon	Code
1824R 08 1808	30,00			1 018240100
1824R 12 1812/150	4,10			1 018240301
1824R 14-M25 1814M/25	4,10			1 018240152
1824R 14-M30 1814M/30	4,10			1 018240153
1824R 14-M40 1814M/40	4,10			1 018240154
1824R 20 1820/30	5,40			1 018240302
1824R 60 1820/60	5,40			1 018240303
1824R 80 1820/80	7,80			1 018240304
1824R 120-180 1822/120 -/180	63,50			1 018240305
1824R 320 1822/320	80,50			1 018240307
1824R ST-60 1823-60	11,10			1 018240308

1825B

soldering tin wire with antioxidant

- 1 mm²; 250 g
- Sn 99.3%; Cu 0.7%



Model	€	Icon	Icon	Code
1825B	59,50			1 018250251

1827

gas soldering iron, adjustable



Model	€	Icon	Icon	Code
1827	127,50			1 018270001

1827PC

spare conical tips for item 1827



Model	€	Icon	Icon	Code
1827PC 1,6	26,50			1 018270501
1827PC 3,2	26,50			1 018270502

1827PCL

spare knife tips for item 1827



Model	€	Icon	Icon	Code
1827PCL 2,4	26,50			1 018270503

1827PFL

spare naked flame tips for item 1827



1827PFL	€ 26,50	1	018270504
---------	---------	---	-----------

1827/K

gas soldering iron with 7 accessories in case with soft polyethylene foam base



CE

Features:

- Power: 30 watts to 125 watts
- Tip temperature can be adjusted between 250 °C and 500 °C
- Gas flow regulator
- Warm-up time: 15 seconds
- Tank contains gas for 120 minutes' non-stop operation
- Clear tank for monitoring gas level
- Can be refilled with butane gas

1827/K	€ 197,50	1	018270100
--------	----------	---	-----------

1827F

butane gas soldering iron

35 g tank

- three interchangeable nozzles: 550 °C; 1000 °C; 1300 °C
- supplied with a stand in hard case



1827F	€ 140,50	1	018270200
-------	----------	---	-----------

1830T

dissoldering pipe with antistatic plastic (PTFE) nozzle



L mm 190	€ 15,00	5	018300021
----------------	---------	---	-----------

LIGHTING

The lighting family comprises a wide range of products designed to satisfy all users' requirements, ranging from inspecting small pipes to lighting large working areas.

FLASHLIGHTS

The new captivating design, the technical improvements and the large choice of sizes allow the most suitable flashlight to be selected on the basis of such criteria as brightness, battery life and performance.

LAMPS AND SPOTLIGHTS

Based on improved LED technology, longer battery life, shorter charging time, painstaking attention to materials and ongoing search for innovative solutions, Beta's work lamps mean an outstanding combination of design, functionality and performance.

A comprehensive range designed to allow professionals to work at their best, in any sector and under any condition.



CRI - Color Rendering Index
CCT - Correlated Color Temperature

SPOTLIGHTS							
ITEM	LUMEN	BATTERY	RECHARGEABLE TIME	LIFE	IP/IK	CCT	CRI
1837C/2100	500/1000/2100	Li-Ion 11.1V; 4400mAh	4.0h	9 - 2.5 h	IP65 - IK07	6500K	80+
1837C/4300	1100/2100/4300	Li-Ion 11.1V; 5200mAh	4.0h	6 - 1.5 h	IP65 - IK07	6500K	80+
1837M	500/1000/2000	Li-Ion 11.1 V, 5200mAh	3.5h	2 - 8 h	IP65 - IK07	2700-3500-4500-5500-6500K	96+
1838FLASH	360/720	Li-Ion 7.4 V; 4000 mAh	4.0h	4 - 8 h	IP65	6300K	-

LAMPS							
ITEM	LUMEN	BATTERY	RECHARGEABLE TIME	LIFE	IP/IK	CCT	CRI
1838/11LED	320	Li-Ion 3.7V; 4200mAh	4.0h	4 h	IP65	6500K	80+
1838AM	60 - 700 120 (spot)	Li-Ion 3.7V; 2600mAh	4.0h - USB-C	2.5 - 16h 10h (spot)	IP54 - IK07	6500K	80+ 70+
1838COB	100/200 75 (spot)	Li-Ion 3.7V; 1600mAh	3.0h	3-6h 4h (spot)	IP65	6000K	80+
1838P	80/50	Li-Ion 3.7V; 700mAh	2.5h	4h	IP20	6000K	80+
1838S	150/350/700 200 (spot)	Li-Ion 3.7 V, 2600mAh	4.0h - USB-C	2 - 7.5h 5h (spot)	IP65 - IK07	6500K	80+
1838SLIM	100/200 180 (back) 80 (spot)	Li-Ion 3.7 V, 700mAh	2.5h - USB-C	2 - 4 h 2 h (back) 3 h (spot)	IP54 - IK07	6500K	80
1838UV	75/150	Li-Ion 3.7V; 1600mAh	3.0h	3h	IP20	6000K	80
1838SL	345	CAVO	-	-	-	-	-

HEADLAMPS							
ITEM	LUMEN	BATTERY	RECHARGEABLE TIME	LIFE	IP/IK	CCT	CRI
1836A	65/120	3xAAA	-	7-14h	IP54 - IK07	6000K	80
1836B	125 - 250	Li-Ion 3.8V; 1600mAh	3.0h	5h	IP65 - IK07	6000K	80+

FLASH LIGHTS							
ITEM	LUMEN	BATTERY	RECHARGEABLE TIME	LIFE	IP/IK	LIGHTING RANGE	
1833XS/1	100	1xAAA	-	5h	IP66	85m	
1833XS/2	200	2xAAA	-	10h	IP66	112m	
1833S	500	2xAA	-	10h	IP66	140m	
1833M	700	3xAAA	-	7.5h	IP66	170m	
1833L	1100	3xAA	-	8.5h	IP66	330m	
1833L/USB	1200	Li-Ion 3.7 V, 2600mAh	3.0h - USB-C	3.0h	IP66	230m	
1833XL	1500	3xD	-	22h	IP66	290m	
1834RR	130	Li-Ion 3.7 V, 550mAh	2.0h	1h	IP30	-	
1837F	500	3xAA	-	14.5h	IP66	125m	
1837F/USB	600	Li-Ion 3.7 V, 2900mAh	4.0h - USB-C	10h	IP66	280m	

1833L/USB

rechargeable high-brightness LED torch,
made of sturdy anodized aluminium,
up to 1,200 lumens

- adjustable focus
- 3 brightness settings
- battery life: 3.0h
- IP66
- lighting range: 230 m
- flat battery indicator (<15%)
- charging via USB-C port
- charger not included



L mm 240 € 107,50 1 018330054

1833RB-L/USB

spare battery for item 1833L/USB

1833RB-L/USB € 49,50 1 018330975

1833KS/1

LED inspection torch,
made of sturdy anodized aluminium

- 100 lumens
- adjustable focus
- battery: 1xAAA (not included)
- IP66
- battery life: 5.0h
- lighting range: 85 m



L mm 92 € 18,70 3 018330000

1833KS/2

LED inspection torch,
made of sturdy anodized aluminium

- 200 lumens
- adjustable focus
- batteries: 2xAAA (not included)
- IP66
- battery life: 10.0h
- lighting range: 112 m



L mm 133 € 20,50 3 018330001

1833S

high-brightness LED torch,
made of sturdy anodized aluminium,
up to 500 lumens

- adjustable focus
- 2 brightness settings
- batteries: 2xAA (not included)
- battery life: 10.0h
- IP66
- lighting range: 140 m



L mm 150 € 35,50 1 018330002

1833M

high-brightness LED torch,
made of sturdy anodized aluminium,
up to 700 lumens

- adjustable focus
- 2 brightness settings
- batteries: 3xAAA (not included)
- flat battery indicator (<15%)
- battery life: 7.5h
- IP66
- lighting range: 170 m



L mm 162 € 44,50 1 018330003

1833L

high-brightness LED torch,
made of sturdy anodized aluminium,
up to 1,100 lumens

- adjustable focus
- 2 brightness settings
- batteries: 3xAA (not included)
- flat battery indicator (<15%)
- battery life: 8.5h
- IP66
- lighting range: 330m



L mm 196 € 73,50 1 018330004

1833XL

high-brightness LED torch,
made of sturdy anodized aluminium,
up to 1,500 lumens

- adjustable focus
- 2 brightness settings
- batteries: 3xD (not included)
- flat battery indicator (<15%)
- battery life: 22.0h
- IP66
- lighting range: 290 m



L mm 300 € 92,00 1 018330005

1834RR

LED torch,
rechargeable in cigarette lighter socket

Adjustable focus
Rechargeable in cigarette lighter socket, 10-28V DC
IP30
130 lumens



1834RR € 48,50 1 018340520

1836A

LED headlamp, dual brightness, with
contactless ON/OFF sensor

- 120/65 lumens
- IP54
- Batteries: 3xAAA included



1836A € 49,00 1 018360050

1836B

rechargeable LED headlamp, dual brightness,
with ON/OFF sensor

- Contactless ON/OFF sensor
- 250 lumens
- Life: 3-6 h
- IP65



1836B € 120,50 1 018360200

1837F

magnetic, articulated lamp with high-brightness LEDs, made of sturdy anodized aluminium, up to 500 lumens

- adjustable focus
- 2 brightness settings
- batteries: 3xAA (not included)
- battery life: 14.5 h
- charge indicator
- IP66



L mm 460 € 79,00 1 018370050

1837F/USB

rechargeable, magnetic, articulated lamp with high-brightness LEDs, made of sturdy anodized aluminium, up to 600 lumens

- adjustable focus
- 2 brightness settings
- battery life: 10.0 h
- USB-C charging
- IP66



L mm 460 € 117,00 1 018370060

1837RB-F/USB

spare battery for item 1837F/USB

1837RB-F/USB € 35,00 1 018370960

1837C

rechargeable LED spotlight for building yards

- 3 brightness settings
- battery charger: input: 100-240V AC - 50/60Hz; output: 15V 1.5A
- charging time: 4 hours
- 3-LED charge indicator
- can rotate up to 180°
- IP65
- IK07



LxHxI mm	Lm	h	€	1	018370210
220x225x70	2100	2.5	174,50	1	018370210
	1000	5.0			
	500	9.0			
266x236.6x59	4300	1.5	256,00	1	018370430
	2100	3.0			
	1100	6.0			

IP65
IK07

1837M

rechargeable LED COLOUR MATCH spotlight, for visual colour control, high colour rendering index (CRI 96+), up to 2,000 lumens

- 3 brightness settings: 500/1,000/2,000 lumens
- CRI (colour rendering index): 96+
- CCT (correlated colour temperature): 2700K/ 3500K/ 4500K/ 5500K/ 6500K
- battery charger: input: 100-240V AC - 50/60Hz; output: 15V 1.5A
- quick release charge connector
- charging time: 3.5 hours
- battery life: 8/4/2 h
- charge indicator
- button and LED colour temperature indicator
- button and LED brightness indicator
- can rotate up to 180°
- IP65
- IK07



IP65
IK07

LxHxI mm	Lm	h	€	1	018370450
220x225x70	500	8.0	272,00	1	018370450
	1000	4.0			
	2000	2.0			

1837S

telescoping tripod for worklight

- made of metal
- adjustable height: 70-155 cm
- compatible with items 1837C and 1838FLASH



h cm 70-170 € 56,50 1 018370500

1838FLASH

rechargeable, ultracompact spotlight, designed to offer the best possible solution for each use

ABUNDANT READY LIGHTING: with a maximum lighting capacity of 720 lumens, and running on both battery and cable, it is always ready to use.

CAN BE PLACED ANYWHERE:

- on flat surfaces: with rubber feet on three sides or 1/4" drive for stands (camera-like standard)
- on metal structures: with unscrewable magnet or hook that can be rotated 360 degrees.

COMPACT: no more than 85x100x155 mm in size, it can be easily replaced in tool bag and used in small areas.

STURDY: designed to withstand extremely severe mechanical stress. Guaranteed durability.



IP65

1838FLASH € 310,00 1 018380300

1838RB/FLASH

spare battery for item 1838/FLASH

1838RB/FLASH € 67,50 1 018380930

1838/11LED

rechargeable inspection lamp with ultra-high brightness LEDs, lithium polymer battery

- Compact body made of antislip rubber
- Easy-to-replace front glass
- Swinging hook
- With charging station, 110-230Vac
- 320 lumens
- With multidirectional head LED



1838/11LED € 153,00 1 018380111

1838RA/10-11LED

spare power supplies for items 1838/10LED and 1838/11LED

1838RA/10-11LED € 32,50 1 018380903

1838RB/10LED

spare battery for items 1838/10LED and 1838/11LED

1838RB/10LED € 51,50 1 018380902

1838RR/11LED

charging bases for item 1838/11LED

1838RR/11LED € 34,00 1 018380914

1838RV/11LED

spare scratch-proof glass for lamp 1838/11LED



1838RV/11LED € 4,65 2 018380905

1838AM

rechargeable LED inspection lamp, with double light emission, articulated, can be rotated 180°, with swivel magnetic base and hook

- double light emission: front: LED COB, 60-700 lumens, can be adjusted with potentiometer
- spot (head): LED SMD, 120 lumens, ON-OFF switch
- rechargeable 3.6V 2600mAh Li-ion battery
- with USB-C port
- supplied with 100-240V / 50-60Hz charger
- charging time: 4h
- battery life: front: 2.5-16h spot (head): 10h
- 3-LED battery level indicator

- articulated, can be rotated 180° (± 90° compared to axis)
- magnetic base (with neodymium magnet), can be rotated 90°
- swivel base hook

- IP54
- IK07



L I S L1
mm mm mm mm
1838AM 405 40 45 175 € 100,00 1 018380400

1838COB

portable rechargeable LED inspection lamp

- with hanging hook and antislip, shockproof body
- lithium polymer battery
- Swinging hook
- Magnetic base can be rotated 180 degrees
- With charger 100-240Vac / 50-60Hz
- 100/200 lumens; SPOT 75 lumens
- Operating range: 6h / 3h; SPOT 4h
- charging time: 3 hours
- IP65

CE
IP65



1838COB € 86,50 1 018380010

1838P

rechargeable inspection pen light, with double light emission: lamp and torch

- Compact body made of non-slip rubber
- 50/80 lumens
- Pocket hook
- Magnetic base can be rotated 180 degrees
- Complete with USB/jack charging cable, 3.5mm
- Life: 2.5 hours
- IP20

CE
IP65



1838P € 74,50 1 018380005

1838SL

ultra-thin inspection lamp with ultra-high brightness LEDs.

For jobs in small areas

- power supply: 12V, with lighter socket and battery terminals
- 2.5-m-long cable
- thickness: 6mm
- 345 lumens

CE



1838SL € 66,00 1 018380101

1838SLIM

rechargeable, articulated slim 3-LED inspection lamp

- triple light emission
- front: 100/200 lumens/ back: 180 lumens/ spot (head): 80 lumens
- magnetic base
- charging time: 2.5h
- battery life: 2-4h/ spot 3h

CE
IP54



L I S
mm mm mm
1838SLIM 307 17 29 € 67,50 1 018380221

Beta

1838S

rechargeable, articulated LED inspection lamp

- can be rotated 180°
- dual light emission, front and spot (head)
- 700 lumens / spot 200 lumens
- nonslip rubber body
- double swinging hook
- magnets on base and back for increased adjustability
- complete with charger (100-240V / 50-60Hz)
- charging time: 4h
- battery life: 2-7,5 h
- dual light emission
- front: 150/300/700 lumens/ spot (head): 200 lumens



	L	I	S	€		
	mm	mm	mm			
1838S	260	52	38	80,00	1	018380122

1838UV

rechargeable UV and white light inspection lamp
ideal for detecting leaks

- Compact body made of antislip rubber
- With charger 100-240Vac / 50-60Hz
- 150 lumens / UV



	€		
1838UV	146,00	1	018380150

1838E

rechargeable under bonnet LED lamp

- triple light emission: 500/1000/2000 lumens
- can be rotated 360°
- length range: 116 ± 188 cm
- aluminium body
- nonslip rubber hooks
- USB-C charge
- 2 charging modes:
charge via lamp USB port
charge via internal battery USB port
- supplied with battery charger
input: 100-240V ~ 50/60Hz
output: DC 5V - 2000 mA



IP20
IK07

L min	L max	I	€		
mm	mm	mm			
1170	1880	150	171,00	1	018380270

1838E-BT

rechargeable battery with USB-C port for
under bonnet lamp item 1838E

- Li-Ion 3,6V
- DC 5V - 2000 mA

CE

	€		
1838E-BT	48,00	1	018380271

1839/R1

transformer with USB output, spare part
for items 1833L/USB, 1836B, 1837F/USB,
1838COB, 1838P, 1838S, 1838SLIM, 1838UV,
1838AM, 1838E

	€		
1839/R1	22,20	1	018390501

1839/R2

USB/jack cable 3.5 mm, spare part for items
1836B; 1838P; 1838COB; 1838UV

	€		
1839/R2	8,55	1	018390502

1839/R4

USB/USB-C cable, spare part for items
1833L/USB, 1833F/USB, 1838SLIM, 1838S,
1838AM, 1838E

	€		
1839/R4	7,50	1	018390504

1840BM

230V inspection lamp,
base type: E27

- Bulb not included



IP20

	V	W	L	€		
		mm	mm			
1840BM	230	60	420	65,00	1	018400101

1842LED/BM

lamp with ultra-high brightness LEDs, 100-
240 Vac

- 10-m-long cable
- compact body made of antislip rubber
- easy-to-replace front glass
- swinging hook
- 340 lumens
- with multi-directional head LED light



	L	€		
	mm			
1842LED/BM	230	126,50	1	018420301

1842LED/ABM

lamp with ultra-high brightness LEDs, 12-24V
AC/DC

- 10-m-long cable
- compact body made of antislip rubber
- easy-to-replace front glass
- swinging hook
- 320 lumens
- with multi-directional head LED light



	L	€		
	mm			
1842LED/ABM	230	119,50	1	018420311

Beta

REELS



Beta's new, varied, comprehensive range of reels has been designed and developed with a view to satisfying all professionals' requirements.

- The range of cable reels comprises numerous lengths and types of cables, versions with LED lamps and with SCHUKO sockets and plugs.
- The range of hose reels comprises hoses 8 mm and 10 mm in diameter.

High-resistance spring ensuring remarkable durability and unparalleled smoothness. Drums made of thick polypropylene, for unique shock resistance. Rack device causing automatic cable rewind to stop, easy to disable, to allow continuous pulling. Each reel is fitted with a 180° swivel wall-mount bracket and an additional bracket for quick connection to, and disconnection from, the wall-mount support.

CABLE REELS

A wide range comprising no less than 18 versions, designed to satisfy any working requirements, including the most demanding users'. Lengths ranging from 10 m to 30 m, and sections from 2x1.0 mm² to 5Gx1.5mm², with H05VV-F and H07RN-F cable types. All the cable reels – up to a cable section of 3Gx2.5mm² - are supplied with thermal protection switches, which are triggered in case of overloading of the electric circuit.



HOSE REELS



326

A selected range, with lengths ranging from 10 m to 15 m, 8 mm and 10 mm in diameter, for use with pneumatic tools. Since our products are leak-proof, they can also be used with water.

Item		Conductors	Section	Cable type	Length	Thermal protection	Accessory
1842 15-H05/LED	018420821	2x	1,0 mm ²	H05VV-F	15+1 m	YES	LED lamp
1843 15-H05	018430215	2x	1,5 mm ²	H05VV-F	15+1 m	YES	
1844 10-H05	018440310	3G	1,5 mm ²	H05VV-F	10+1 m	YES	-
1844 15-H05	018440315			H05VV-F	15+1 m	YES	-
1844 15-H07	018440317			H07RN-F	14+1 m	YES	-
1844 30-H05	018440330			H05VV-F	30+2 m	YES	-
1844 15-H05/SCK	018440316	3G	1,5 mm ²	H05VV-F	15+1 m	YES	SCHUKO
1844 15-H07/SCK	018440318			H07RN-F	14+1 m	YES	SCHUKO
1845 12-H05	018450365	3G	2,5 mm ²	H05VV-F	12+1 m	YES	
1845 15-H07	018450367			H07RN-F	15+1 m	YES	
1845 25-H07	018450377			H07RN-F	25+1,5 m	YES	
1846 10-H05	018460405	4G	1,5 mm ²	H05VV-F	10+1 m	NO	
1846 10-H07	018460407			H07RN-F	10+1 m	NO	
1846 15-H05	018460415			H05VV-F	15+1 m	NO	
1847 10-H05	018470420	4G	2,5 mm ²	H05VV-F	10+1 m	NO	
1847 15-H07	018470427			H07RN-F	15+1 m	NO	
1848 10-H05	018480510	5G	1,5 mm ²	H05VV-F	10+1 m	NO	
1848 15-H07	018480517			H07RN-F	15+1 m	NO	

1842

automatic cable reel with LED inspection lamp, 100-240Vac

- with 230/12V safety transformer
- H05VV-F 2x1.0 mm² cable
- coiled cable length: 15 m
- 1.5 m incoming cable with SCHUKO type socket
- length of cable out of drum: 1 m
- rack mechanism can be disabled to keep cable pulled
- supplied with a 180° swivel bracket and an additional quick connection bracket

CE

IP42
IP65



1842 15-H05/LED	H05VV-F	15+1	€ 317,00	1	018420821
-----------------	---------	------	----------	---	-----------

1846R-LED/BM

spare LED lamps

12-24V - AC-DC



1846LED/BM R	€ 87,00	1	018460331
--------------	---------	---	-----------

1843

automatic cable reel, with 2x1.5 mm² cable

- H05VV-F 2x1,5 mm² cable
- with thermal protection switch
- coiled cable length: 15 m
- cable length out of drum: 1 m
- supplied without incoming cable
- rack mechanism can be disabled to keep cable pulled
- max. power (rolled up): 1300W (230V-20°C)
- max. power (unrolled): 2300W (230V-20°C)
- supplied with a 180° swivel bracket and an additional quick connection bracket

CE

IP42



1843 15-H05	H05VV-F	15+1	€ 212,00	1	018430215
-------------	---------	------	----------	---	-----------

1844

automatic cable reel, with 3Gx1.5 mm² cable

- 3Gx1.5 mm² cable
- with thermal protection switch
- cable length out of drum: 1 m (except for 1844 30-H05, 2 m)
- supplied without incoming cable
- rack mechanism can be disabled to keep cable pulled
- max. power (rolled up): 1500W (230V-20°C)
- max. power (unrolled): 2500W (230V-20°C)
- supplied with a 180° swivel bracket and an additional quick connection bracket

CE

IP42



L
m

€

1

018440310

1844 10-H05	H05VV-F	10+1	212,00	1	018440310
1844 15-H05	H05VV-F	15+1	188,50	1	018440315
1844 15-H07	H07RN-F	14+1	213,00	1	018440317
1844 30-H05	H05VV-F	30+2	397,00	1	018440330

1844SCK

automatic cable reel, with 3Gx1.5 mm² cable and SCHUKO type socket

- 3Gx1.5 mm² cable
- with thermal protection switch
- length of cable out of drum: 1 m
- supplied with 1.5 m incoming cable and SCHUKO type socket
- rack mechanism can be disabled to keep cable pulled
- max. power (rolled up): 1500W (230V-20°C)
- max. power (unrolled): 2500W (230V-20°C)
- supplied with a 180° swivel bracket and an additional quick connection bracket

CE

IP42



L=15 m



L
m

€

1

018440316

1844 15-H05/SCK	H05VV-F	15+1	221,50	1	018440316
1844 15-H07/SCK	H07RN-F	14+1	228,50	1	018440318

Beta

1845

automatic cable reel, with 3Gx2.5 mm² cable

- 3Gx2.5 mm² cable
- with thermal protection switch
- cable length out of drum: 1 m (except for 1845 25-H07RN-F, 1.5 m)
- supplied without incoming cable
- rack mechanism can be disabled to keep cable pulled
- max. power (rolled up): 2000W (230V-20°C)
- max. power (unrolled): 3000W (230V-20°C)
- supplied with a 180° swivel bracket and an additional quick connection bracket

CE

IP42



L
m

€

1

018450365

1845 12-H05	H05VV-F	12+1	427,00	1	018450365
1845 15-H07	H07RN-F	15+1	427,00	1	018450367
1845 25-H07	H07RN-F	25+1.5	538,00	1	018450377

1846

automatic cable reel, with 4Gx1.5 mm² cable

- 4Gx1.5 mm² cable
- without thermal protection switch
- cable length out of drum: 1 m
- supplied without incoming cable
- rack mechanism can be disabled to keep cable pulled
- max. power (rolled up): 1400W (230V-20°C)
- max. power (unrolled): 1900W (230V-20°C)
- supplied with a 180° swivel bracket and an additional quick connection bracket

CE

IP42



L
m

€

1

018460405

1846 10-H05	H05VV-F	10+1	229,50	1	018460405
1846 10-H07	H07RN-F	10+1	237,50	1	018460407
1846 15-H05	H05VV-F	15+1	237,50	1	018460415

1847

automatic cable reel, with 4Gx2.5 mm² cable

- 4Gx2.5 mm² cable
- without thermal protection switch
- length of cable out of drum: 1 m
- supplied without incoming cable
- rack mechanism can be disabled to keep cable pulled
- max. power (rolled up): 2000W (230V-20°C)
- max. power (unrolled): 2700W (230V-20°C)
- supplied with a 180° swivel bracket and an additional quick connection bracket

CE

IP42



L
m

€

1

018470420

1847 10-H05	H05VV-F	10+1	247,00	1	018470420
1847 15-H07	H07RN-F	15+1	459,00	1	018470427

1848

automatic cable reel, with 5Gx1.5 mm² cable

- 5Gx1.5 mm² cable
- without thermal protection switch
- length of cable out of drum: 1 m
- supplied without incoming cable
- rack mechanism can be disabled to keep cable pulled
- max. power (rolled up): 1400W (230V-20°C)
- max. power (unrolled): 1900W (230V-20°C)
- supplied with a 180° swivel bracket and an additional quick connection bracket

CE

IP42



L
m

€

1

018480510

1848 10-H05	H05VV-F	10+1	256,00	1	018480510
1848 15-H07	H07RN-F	15+1	490,00	1	018480517

1850D

3-speed heat gun

- Pos. I 250 l/min 50 °C
- Pos. II 250 l/min 400 °C
- Pos. III 500 l/min 550 °C

CE

1800W
50-550 °C



220/240V

L
mm

H
mm

€

1

018500018

1850D	255	210	118,00	1	018500018
-------	-----	-----	--------	---	-----------

Beta

1850E

adjustable electronic heat gun

- Pos. I 250-500 l/min 50 °C
- Pos. II 250-500 l/min 50-650 °C

- digital display
- temperature and flow rate adjustment buttons
- 4 preset programmes and other customizable programmes

- Prog 1 150 °C ca. 400 l/min
- Prog 2 200 °C ca. 400 l/min
- Prog 3 300 °C ca. 450 l/min
- Prog 4 400 °C ca. 500 l/min



Model	L mm	H mm	Price (€)	Weight (kg)	Code
1850E	255	210	247,50	1	018500020

1851VK

hot glue gun with 12 thermofusibile glue sticks in case



Model	Price (€)	Weight (kg)	Code
1851VK	49,00	1	018510058

320x250x50 mm

1851VK-12C

12 thermofusibile glue sticks Ø 11 mm



Model	Price (€)	Weight (kg)	Code
1851VK-12C	12,50	1	018510062

1851VK-12V

12 thermofusibile glue sticks for painted surfaces Ø 11 mm



Model	Price (€)	Weight (kg)	Code
1851VK-12V	12,50	1	018510072

1852R1750

portable induction heater



Heats and loosens bolts, hubs and bearings without using flames. Allows any type of ferromagnetic metal to be heated.

Standard equipment:

- Two front attachable coils, Ø 19 and 26 mm, for loosening nuts
- One flat coil for heating surfaces
- One flexible coil, 800 mm long
- Supplied in plastic case

Technical data:

- Input voltage: 230V AC, 50/60 Hz
- Input current: max. 7,5A
- Power: max. 1.75 kW

Optional Equipment:

- Coils are also available in other sizes

Benefits:

- Time saving: quick, extremely accurate heating
- Fire safety: does not produce flames, maximum operator safety
- Functional: can be used with one hand, and coils can be easily interchanged

Fields of Application:

- Automotive industry
- Industrial maintenance
- Aviation industry
- Naval industry
- Petrochemical industry

Model	Price (€)	Weight (kg)	Code
1852R1750	1.395,00	4,5	018520175

1852S-CNT

contact coil



Model	Price (€)	Weight (kg)	Code
1852S-CNT	104,50	1	018520520

1852S-CC

spoon coil



Model	Price (€)	Weight (kg)	Code
1852S-CC	84,00	1	018520521

1852S-KR/CNT

kit of spare parts for contact coil



Model	Price (€)	Weight (kg)	Code
1852S-KR/CNT	45,50	1	018520522

1852S-L

side attachable coils



Model	Ø mm	M	L mm	Price (€)	Weight (kg)	Code
1852S-L 19	19	M6	220	42,50	1	018520501
1852S-L 20	20	M8	220	42,50	1	018520502
1852S-L 23	23	M10	220	42,50	1	018520503
1852S-L 26	26	M12	220	42,50	1	018520504
1852S-L 32	32	M16	220	42,50	1	018520505
1852S-L 38	38	M20	220	48,50	1	018520506
1852S-L 45	45	M22	220	53,50	1	018520507

1852S-F

front attachable coil



Model	Ø mm	M	L mm	Price (€)	Weight (kg)	Code
1852S-F 19	19	M6	220	42,50	1	018520508
1852S-F 20	20	M8	220	42,50	1	018520509
1852S-F 23	23	M10	220	42,50	1	018520510
1852S-F 26	26	M12	220	42,50	1	018520511
1852S-F 32	32	M16	220	42,50	1	018520512
1852S-F 38	38	M20	220	48,50	1	018520513
1852S-F 45	45	M22	220	52,00	1	018520514

1852S-FLESS

flexible coil



Model	Price (€)	Weight (kg)	Code
1852S-FL 750	31,50	1	018520519
1852S-FL 800	79,00	1	018520515
1852S-FL1000	101,50	1	018520517
1852S-FL1500	120,50	1	018520518

1852 S-PIATTE

flat coil



Model	Price (€)	Weight (kg)	Code
1852S-PIATTE	48,50	1	018520516

Beta
Quality Tools

1860 160A

DC inverter welding machine for MMA and TIG electrode steel welding.

Compact and easy to carry

Arc force, hotstart, anti-sticking and thermostatic protection features

Adjustment current: 5÷160A
Power supply: 1x230V

Use factor (40 °C) :
30% - 160 A
60% - 1030 A
100% - 110 A
Delayed fuse: 25 A
Protection: IP23S
Usable electrodes: Ø 1.5 - 4mm rutilic, basic, stainless steel, cast iron etc.
Supplied with 25mm² cables



1860 160A	€ 851,00	1	018600006
-----------	----------	---	-----------

1860RC

spare cables for inverter welding machines item 1860

electrode holder cable length: 2.5m
earth cable length: 1.8m



1860RC/140A	€ 78,00	1	018600604
1860RC/160A	€ 99,50	1	018600606

1860EI

magnetic square, 90°, for interior and exterior angles

Ideal for locking tubular or flat parts, 18 kg magnetic force, with bevels for 30° and 60° angles, with hexagon hole making it easier to separate magnet from metal



1860EI	€ 32,50	1	018600290
--------	---------	---	-----------

1860RG

adjustable magnetic square, 30°÷270°

Ideal for locking tubular or flat parts, 15 kg magnetic force, supplied with an offset hexagon key wrench for locking angle adjustment mechanism, supplied with a pin for locking angle adjustment mechanism at 30°-45°-90°/270°-180° with hexagon hole making it easier to separate magnet from metal



1860RG	€ 52,00	1	018600255
--------	---------	---	-----------

1860SQ

magnetic square, 45°/90°

ideal for locking tubular or flat parts
25 kg magnetic force
no battery required, ON/OFF effect obtained by tilting interior magnets
easier chip removal with magnets in OFF position

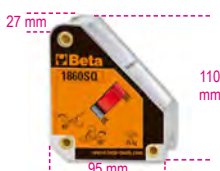

1860SQ	€ 78,50	1	018600210
--------	---------	---	-----------

7041LCD/4S

auto-darkening LCD mask, for electrode welding; MIG/MAG; TIG and plasma.
4 sensors with TRUE COLOR filter
solar cell power supply and lithium batteries for outstanding LCD filter life

- Viewing area: 98x80 mm
- Darkening shade range: 5÷8.5/ 9-13, internally adjustable
- UV/IR protection: DIN16
- Light to dark time: 1/25000 s
- Dark to light time: 0.1-2.0s
- Adjustable darkening sensitivity and delay
- Auto on/off
- Grinding feature
- Low battery indicator
- Ergonomic design, lightweight, well-balanced
- With adjustable ring nut



7041LCD/4S	€ 256,00	1	070410001
------------	----------	---	-----------

7041LCD/4S-VE

scratch-proof lens protector for item 7041LCD/4S

7041LCD/4S-VE	€ 6,25	2	070410101
---------------	--------	---	-----------

7041LCD/4S-VI

inside lens for item 7041LCD/4S

7041LCD/4S-VI	€ 3,15	2	070410102
---------------	--------	---	-----------

7042LCD

Auto-darkening LCD mask, for electrode welding; MIG/MAG; TIG and plasma.
Solar cells power supply and lithium batteries for outstanding LCD filter life

- Viewing area: 98x43 mm
- Darkening shade: DIN 9-13, externally adjustable
- UV/IR protection
- Light to dark time: 1/25000 s
- Dark to light time: 0.25-1s
- Adjustable darkening sensitivity and delay
- Auto on/off
- Grinding feature
- Optimized shape to make it easier to breathe with pulled-down screen



7042LCD	€ 180,00	1	070420001
---------	----------	---	-----------

7042LCD/RV

scratch-proof lens protector for item 7042LCD, 7043

7042LCD/RV	€ 2,84	2	070420101
------------	--------	---	-----------

7042LCD/RV-INT

inside lens for item 7042LCD, 7043

7042LCD/RV-INT	€ 2,49	2	070420102
----------------	--------	---	-----------

7043

auto-darkening LCD mask, for electrode welding, MIG/MAG, TIG and plasma, solar cell power supply

- viewing area: 92x43 mm
- darkening shade: DIN 9-13, externally adjustable
- UV/IR protection
- light to dark time: 1/1000 s
- dark to light time: 0.1-1.0 s
- adjustable darkening delay
- auto on/off
- grinding feature
- optimized shape to make it easier to breathe with pulled-down screen



CE

7043 € 104,50 1 070430001

1870

solid and fluid vacuum cleaner, 20 l

- single-stage by-pass motor
- voltage: 230/240 V
- frequency: 50/60 Hz
- max. power: 1200 W
- airflow rate: 58 l/sec.
- max. suction power: 190 mbar
- max. drum capacity: 20 l, made of antistatic PP
- acoustic emissions: <70 dB(A)
- cable length: 5 m
- trolley for accessories
- STANDARD ACCESSORIES, Ø 36 mm
- 1 corrugated hose with ergonomic handle
- 2 hard extension tubes
- 1 multiuse brush for floors and fluids
- 1 flat nozzle
- FILTERING SYSTEMS
- 1 surface filter cartridge 1900 cm² - 12 µm nom.
- 1 anti-foam filter PPI 45/PPI 30

CE



IPX4

1870 € 211,00 1 018700020

1870I

solid and fluid vacuum cleaner, 20 l, stainless steel drum

- single-stage by-pass motor
- voltage: 230/240 V
- frequency: 50/60 Hz
- max. power: 1200 W
- airflow rate: 58 l/sec.
- max. suction pressure: 190 mbar
- max. drum capacity: 20 l, made of stainless steel
- acoustic emissions: <70 dB(A)
- cable length: 5 m
- STANDARD ACCESSORIES Ø 36 mm
- 1 corrugated hose with ergonomic handle and vent
- 2 hard extension tubes
- 1 multiuse brush for floors and fluids
- 1 flat nozzle
- 1 paper bag
- FILTERING SYSTEMS
- 1 surface air filter cartridge 1900 cm² - 12 µm nom.
- 1 anti-foam filter PPI 45/PPI 30

CE



IPX4

1870I € 234,50 1 018700220



1872L

solid and fluid vacuum cleaner, 35 l

"L" class certified

- two-stage by-pass motor
- voltage: 230/240 V • frequency: 50/60 Hz
- max. power: 1100 W
- airflow rate: 55 l/sec.
- max. suction power: 220 mbar
- max. drum capacity: 35 l, made of antistatic PE-HD
- acoustic emissions: <68 dB(A)
- cable length: 6 m
- STANDARD ACCESSORIES, Ø 36 mm
- 1 corrugated hose with ergonomic handle
- 2 plastic extension tubes
- 1 combined brush frame
- 1 section with fluid collection hoses
- 1 flat nozzle
- FILTERING SYSTEMS
- 1 disposable fabric bag; filtration class: "L"
- 1 filter cartridge; IFA class: "L"
- 1 anti-foam filter PPI 45/PPI 30
- 2 post-filters made of PP-laminated PET

CE



IPX4

1872L € 460,00 1 018720135

1873

solid and vacuum cleaner, 30 l, stainless steel drum

- two-stage by-pass motor
- voltage: 230/240 V • frequency: 50/60 Hz
- max. power: 1100 W • airflow rate: 55l/sec.
- max. suction pressure: 220 mbar
- max. drum capacity: 30 l, made of stainless steel
- acoustic emissions: <61 dB(A)
- cable length: 6 m • trolley for accessories
- STANDARD ACCESSORIES, Ø 45 mm
- 1 corrugated hose with ergonomic handle
- 2 stainless steel extension tubes
- 1 industrial brush frame • 1 industrial section for carpets
- 1 industrial section with fluid collection hoses
- 1 flat nozzle
- FILTERING SYSTEMS
- 1 filter paper bag
- 1 surface filter cartridge 1900 cm², 12 µm nom.
- 1 anti-foam filter PPI 45/PPI 30

CE



1873 30 € 613,00 1 018730030

1874

solid and fluid vacuum cleaner, 50 l, stainless steel drum

- two-stage by-pass motor
 - voltage: 230/240 V • frequency: 50/60 Hz
 - max. power: 1350 W • airflow rate: 55 l/sec.
 - max. suction pressure: 240 mbar
 - max. drum capacity: 50 l, made of stainless steel
 - acoustic emissions: <63 dB(A)
 - cable length: 6 m
 - trolley for accessories
- STANDARD ACCESSORIES, Ø 45 mm
- 1 corrugated hose with ergonomic handle
 - 2 stainless steel extension tubes
 - 1 industrial brush frame
 - 1 industrial section for carpets
 - 1 industrial section with fluid collection hoses
 - 1 flat nozzle
- FILTERING SYSTEMS
- 1 filter bag
 - 1 surface filter cartridge 5200 cm², 12 µm nom.
 - 1 anti-foam filter PPI 45/PPI 30

CE



1874 50 € 774,00 1 018740050

1870-20/5S

5 horizontal paper bags for item 1870



1870 20/5S € 49,50 1 018700021

1870-72 /FC

cartridge filter 1900 cm² 12 - µm nom. for items 1870 - 1872 - 1873



1870-72 /FC € 42,50 1 018700026

1870-72/FL

fluid vacuum cleaning filter for items 1870 - 1872 - 1873 - 1874



1870 72/FL € 15,60 1 018700027

1872L 35/FC

cartridge filter, "L" class, for item 1872L 35



1872L 35/FC € 51,50 1 018720144

1872L 35/5S

5 disposable fabric bags, "L" class



1872L 35/5S € 78,00 1 018720136

1873-30/5S

5 vertical paper bags for item 1873



1873 30/5S € 49,50 1 018730031

1874-50/5S

5 vertical bags for item 1874



1874 50/5S € 62,50 1 018740051

1874-50/FC

cartridge filter 5200 cm² - 12 µm nom. for item 1874



1874 50/FC € 51,00 1 018740056

1877

exhausted oil drain unit, wheeled, with 90 l tank

- level indicator
- big diameter pan with breakwater grate; capacity: 12 l
- pneumatic tank emptying through 1.8 m pipe
- tool tray

CE



1877 € 664,00 1 018770008

1877A

exhausted oil drain unit / vacuum cleaner, wheeled, with 90 l tank and pre-chamber

- level indicator
- big diameter pan with breakwater grate; capacity: 12 l
- transparent pre-chamber: capacity 9.5 l
- 1.8 m suction pipe
- pneumatic tank emptying through 1.8 m pipe
- tool tray

Standard accessories:

- 1 hard probe, Ø 5x700 mm
- 1 flexible probe, Ø 5x700 mm
- 1 hard probe, Ø 6x600 mm
- 1 flexible probe, Ø 6x700 mm
- 1 flexible probe, Ø 7x700 mm
- 1 flexible probe, Ø 8x700 mm
- adapters for VW, BMW, CITROËN

CE



1877A € 1.172,00 1 018770080

VEHICLE REPAIR

Our vehicle repair tools, which are used by the most demanding professionals, are developed and manufactured to meet the world's highest standards, and regularly tested under the most stressful operating conditions.

For over 50 years, we have been proudly working hand in hand with the greatest champions, who help us improve our products non-stop and provide testimony to the highest quality standard.

The vehicle repair tools are found in these sections:

Diagnostics	items 1438 to 1499 items 1758VT to 1760TMC
Engine	items 955 to 989A items 1438 to 1499
Oil and filters	items 1438 to 1499 items 1877 to 1885
Electric system	items 1438 to 1499
Transmission	items 1438 to 1499
Suspension	items 1549 to 1569CP
Brakes	items 1438 to 1499
Wheels	items 955 to 989A
Body work	items 1302 to 1369 items 1763 to 1767A
Other equipment	items 1878 to 3067



1878 2

fluid collection tank

- maximum capacity: 2 l
- particularly suitable for changing oil in scooters



1878 2	2	H mm 85	€ 13,60	1	018780002
--------	---	---------------	------------	---	-----------

1878 3

oil collection tank,
for truck hubs

With oil drip catcher



1878 3	3		€ 20,50	1	018780003
--------	---	--	------------	---	-----------

1878 4

fluid collection tank,
portable

- suitable for motorcycles
- maximum capacity: 4 l
- reduced splashing



1878 4	4	H mm 100	€ 28,50	1	018780004
--------	---	----------------	------------	---	-----------

1878 8

fluid collection tank

- height suitable for motorcycles
- maximum capacity: 8 l



1878 8	8	H mm 110	€ 15,30	1	018780008
--------	---	----------------	------------	---	-----------

1878 11

fluid collection tank

- Maximum capacity: 11 l
- Fluid drain plug
- Interior wall for preventing fluid leakage during transportation



1878 11	11		€ 34,50	1	018780011
---------	----	--	------------	---	-----------

1878 30

fluid collection tank

- Maximum capacity: 30 l
- Splashproof grate
- Fitted with 4 pivoting wheels

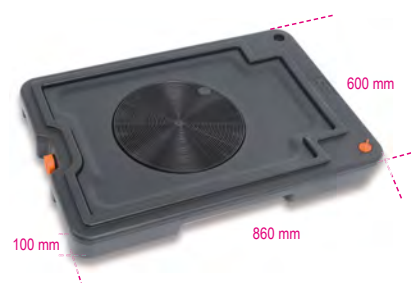

1878 30	30		€ 133,00	1	018780030
---------	----	--	-------------	---	-----------

1879

9.5 l manual/pneumatic operation fluid
extractor



1879			€ 286,00	1	018790001
------	--	--	-------------	---	-----------

1879 6

manual operation fluid extractor,
6 l



1879 6			€ 209,00	1	018790006
--------	--	--	-------------	---	-----------

1879R/K4

kit of 4 spare tubes for fluid extractor 1879



1879R/K4 € 55,50 1 018790504

1879/FUEL

manual operation fluid extractor,
6 l
for use with hydrocarbons



1879/FUEL 6 € 124,50 1 018790010

1880

manual barrel pump



1880 gr 240 € 54,00 1 018800001

1880ADB

rotary AdBlue® pump

- 5 litres supplied every twenty turns
- drum extensions up to 1.20 m
- 1 fine-pitch drum coupling, fine pitch
- 1 coarse-pitch drum coupling



1880ADB € 125,50 1 018800101

1881

pneumatic barrel pump, ratio 3:1



1881 l/min 14 € 460,00 1 018810001

1882

oil gun with flexible end and automatic drip catcher

- 1/2"
- Maximum delivery rate: 65 l/min
- Maximum operating pressure: 100 bar
- Lockable delivery lever



1882 € 138,50 1 018820010

1883

digital litre counter for oil

- 1/2"
- Shockproof rubber coating
- Battery: 1 CR2 (included)
- Max. delivery rate: 0÷35 l/min (0÷9 gal/min)
- Max. pressure: 50 bar (750 psi)
- Viscosity: 8÷5000 mPas
- Tolerance: ±0.5%

CE



1883 € 210,00 1 018830035

1883NC

male-male nipple, 1/2,
for items 1882 and 1883



1883NC € 13,00 1 018830135

1884

oil filler tool
for manual and automatic gearboxes and
differentials

Complete with 12 adaptors for direct connection



1884 € 454,00 1 018840010

AT-101	FORD
AT-102	UNIVERSAL (Bmw, Honda, Nissan...)
AT-103	VW-AUDI
AT-104	VW-AUDI-PORSCHE
AT-105	VW-AUDI-MINI COOPER
AT-106	MERCEDES
AT-107	DSG
AT-108	VW-AUDI CVT
AT-109	VOLVO
AT-110	TOYOTA-LEXUS
AT-111	SKODA
AT-112	VW Passat/Tiguan <2007

1884/C12

case of adaptors for item 1884



1884/C12 € 168,00 1 018840100



1884N/C8

set of 8 adapters for item 1884

set contents:

- 1 adapter for Infiniti, 7-speed, M8x1.0
- 1 adapter for Honda, Hyundai, Kia 5x8x200 mm
- 1 adapter for Skoda M18x1.5
- 1 adapter for Mini M14x1.5
- 1 adapter for Nissan M10x1.5
- 1 adapter for Nissan Juke M12x1.25
- 1 adapter for GM M12x1.75
- 1 adapter for VAG group vehicles, 7-gear



1884N/C8 € 110,00 1 018840200

200x145x40 mm - 400 g

1889

steel handling and storage base for 2 200-l barrels

- Completely hot painted with epoxy powder
- Easy to carry with a fork lift truck or a transpallet
- Support cannot be placed under any part

CE



1889 € 756,00 1 018890200

1889CF

universal barrel opening wrench

- 1 female hexagon Ø 38 mm
- 1 4-sector profile Ø 42 mm
- 1 blade 17x7 mm



L mm 270 € 32,00 1 018890010

1885

automatic gearbox maintenance station

Allows entire washing cycle to be safely performed in all automatic transmissions, through a simple, guided procedure. Avoids damage from wear of oil in automatic gearbox, thereby easily and quickly preventing typical malfunctions, including: excessive gearbox noise, jammed gears, abruptly engaged gears, long gear shifting time.



CE



Functional specifications:

- Automatic operation
- Step-by-step guided procedure with integrated database
- Balancing quantity of injected oil with same quantity of exhausted oil, thereby making sure that system always contains proper quantity of oil
- Flow meter for visual inspection of oil quantity
- Printing records of each operation

Automatic specifications:

- Injecting solvent (optional)
- Washing gearbox system
- Emptying oil out of sump
- Emptying oil out of converter
- Injecting oil into converter

Technical specifications:

- Power supply: 220 V 50 Hz
- Backlit oil viewers with 2 white light LEDs
- 2 electronic balances
- Electronic balances, resolution +/- 10 g
- Electronic card with backlit graphic display

1885 € 8.040,00 1 018850010



Beta

1885/C1

automatic transmission fittings kit for item 1885

Kit contents:

- 1885/C1-R1 Land Rover Freelander transmission fittings
- 1885/C1-R2 DP0 transmission fitting
- 1885/C1-R3 ZF 9HP transmission fitting
- 1885/C1-R4 ZF 9HP transmission dipstick
- 1885/C1-R5 Mercedes transmission dipstick
- 1885/C1-R6 AISIN TG82 transmission fittings
- 1885/C1-R7 AISIN TG81 transmission fittings
- 1885/C1-R8 Renault-Nissan transmission fittings



1885/C1 € 692,00 1 018850110

1885/C1-R1

Land Rover Freelander transmission fittings for item 1885

Ic01430



1885/C1-R1 € 60,00 1 018850111

1885/C1-R2

DP0 transmission fitting for item 1885

Ic0990



1885/C1-R2 € 104,50 1 018850112

1885/C1-R3

ZF 9HP transmission fitting for item 1885

Ic0992



1885/C1-R3 € 116,50 1 018850113

1885/C1-R4

ZF 9HP transmission dipstick for item 1885

Ic0192



1885/C1-R4 € 65,00 1 018850114

1885/C1-R5

Mercedes transmission dipstick for item 1885

K-A-M



1885/C1-R5 € 107,50 1 018850115

1885/C1-R6

AISIN TG82 transmission fittings for item 1885

Ic01820



1885/C1-R6 € 115,50 1 018850116

1885/C1-R7

AISIN TG81 transmission fittings for item 1885

Ic0150



1885/C1-R7 € 115,50 1 018850117

1885/C1-R8

Renault-Nissan transmission fittings for item 1885

Ic02150



1885/C1-R8 € 115,50 1 018850118

1885/C2

automatic transmission fittings kit for item 1885

Kit contents:

- 1885/C2-R1 Audi 8HP transmission fittings
- 1885/C2-R2 ZF 9HP transmission fittings without exchanger
- 1885/C2-R3 Audi 0KC transmission fitting
- 1885/C2-R4 AG4-ZF 4HP transmission fittings
- 1885/C2-R5 FIAT transmission fittings
- 1885/C2-R6 Audi Q5-Q7 transmission fittings
- 1885/C2-R7 Audi 0B5 transmission fitting



1885/C2 € 563,00 1 018850120

1885/C2-R1

Audi 8HP transmission fittings for item 1885

Ic0993



1885/C2-R1 € 113,00 1 018850121

1885/C2-R2

ZF 9HP transmission fittings without exchanger for item 1885

Ic0860



1885/C2-R2 € 74,00 1 018850122

1885/C2-R3

Audi 0KC transmission fitting for item 1885

Ic02020



1885/C2-R3 € 115,50 1 018850123

1885/C2-R4

AG4-ZF 4HP transmission fittings for item 1885

Ic0750



1885/C2-R4 € 99,50 1 018850124

1885/C2-R5

FIAT transmission fittings for item 1885

Ic0061



1885/C2-R5 € 44,00 1 018850125

1885/C2-R6

Audi Q5-Q7 transmission fittings for item 1885

Ic0680



1885/C2-R6 € 107,50 1 018850126

1885/C2-R7

Audi 0B5 transmission fitting for item 1885

Ic01720



1885/C2-R7 € 65,00 1 018850127

1885/C3

automatic transmission fittings kit for item 1885

Kit contents:

- 1885/C3-R1 Mercedes DSG transmission fitting
- 1885/C3-R2 POWERSHIFT transmission fitting
- 1885/C3-R3 Toyota IQ transmission fittings
- 1885/C3-R4 Mazda transmission fittings
- 1885/C3-R5 Renault Laguna-Esp transmission fittings
- 1885/C3-R6 Nissan Juke transmission fittings
- 1885/C3-R7 AISIN TF71 FV transmission fittings
- 1885/C3-R8 AISIN TF71 FP transmission fittings
- 1885/C3-R9 AISIN TF71 FO transmission fittings
- 1885/C3-R10 AISIN TF71 FS transmission fittings



1885/C3 € 993,00 1 018850130

1885/C3-R1

Ic0191



1885/C3-R1 € 115,50 1 018850131

1885/C3-R2

POWERSHIFT transmission fitting for item 1885

Ic0190



1885/C3-R2 € 115,50 1 018850132

1885/C3-R3

Toyota IQ transmission fittings for item 1885

Ic0991



1885/C3-R3 € 115,50 1 018850133

1885/C3-R4

Mazda transmission fittings for item 1885

Ic02130



1885/C3-R4 € 115,50 1 018850134

1885/C3-R5

Renault Laguna-Esp transmission fittings for item 1885

Ic02150



1885/C3-R5 € 115,50 1 018850135

1885/C3-R6

Nissan Juke transmission fittings for item 1885

Ic02140



1885/C3-R6 € 115,50 1 018850136

1885/C3-R7

AISIN TF71 FV transmission fittings for item 1885

Ic01420



1885/C3-R7 € 115,50 1 018850137

1885/C3-R8

AISIN TF71 FP transmission fittings for item 1885

Ic001420/1



1885/C3-R8 € 115,50 1 018850138

1885/C3-R9

AISIN TF71 FO transmission fittings for item 1885

Ic001420/2



1885/C3-R9 € 115,50 1 018850139

1885/C3-R10

AISIN TF71 FS transmission fittings for item 1885

Ic001420/3



1885/C3-R10 € 115,50 1 018850140

1893/134A

automatic charging station for R134a gas air conditioners

Fully automatic model, complete with car/lorry database with gas quantities, compressor oil quantities and types, self-diagnosis software for routine maintenance jobs. Database can be updated via software. Machine can be operated in both manual mode (provided it is controlled by a human operator step by step) and in fully automatic mode (without requiring a human operator).



R134A (250 ml)

FUNCTIONAL SPECIFICATIONS

Automatic operation
Car/lorry database with gas quantities and compressor oil quantities and types
Automatic gas recovery from pipe
Compensation of recharged quantity of gas in pipes
Automatic discharge of noncondensable gases
Automatic reporting of defects and required maintenance jobs
Gauges, ø 80 mm
Digital vacuummeter

TECHNICAL SPECIFICATIONS

Gas tank: 15 kg
Vacuum pump: 75 l/min
Electronic balance: 50 kg
Electronic card with backlit display
Recovery rate: 500 rpm
Power supply: 220 V

1893/134A € 5.850,00 1 018930001

1893/1234YF

automatic charging station for R1234yf gas air conditioners

Fully automatic model, complete with car/lorry database with gas quantities, compressor oil quantities and types, self-diagnosis software for routine maintenance jobs. Database can be updated via software. Machine can be operated in both manual mode (provided it is controlled by a human operator step by step) and in fully automatic mode (without requiring a human operator).



1234YF (250 ml)

FUNCTIONAL SPECIFICATIONS

Automatic operation
Car/lorry database with gas quantities and compressor oil quantities and types
Automatic gas recovery from pipe
Compensation of recharged quantity of gas in pipes
Automatic discharge of noncondensable gases
Automatic reporting of defects and required maintenance jobs
Gauges, ø 80 mm
Digital vacuummeter

TECHNICAL SPECIFICATIONS

Gas tank: 15 kg
Vacuum pump: 75 l/min
Electronic balance: 50 kg
Electronic card with backlit display
Recovery rate: 500 rpm
Power supply: 220 V

1893/1234YF € 6.040,00 1 018930012

1893TR/134A

R134a gas tracer



1893TR/134A ml 250 € 41,00 1 018930901

1893TR/1234YF

R1234yf gas tracer



1893TR/1234YF ml 250 € 46,50 1 018930902

Beta

1893TR/CI

hybrid compressor tracer



1893TR/CI	ml 250	€ 48,50	1	018930903
-----------	-----------	------------	---	-----------

1895G

control generator for (petrol and LPG) electro-injectors and solenoid valves

Makes it possible to autonomously test efficiency of such parts as:

- EGR solenoid valves
- electro-injectors of petrol and LPG engines
- solenoid valves for variable-geometry turbine adjustment
- compressors for new-generation air conditioners



Benefits:

- Makes it possible to understand whether part is working mechanically
- Combined with ultrasonic cleaning tanks, it allows more efficient cleaning of parts, electronically controlling part during washing phase
- Essential for air conditioner testing, to check whether compressor and its control valve are efficient

Specifications

Petrol and LPG injector control:

- Number of outlets: 4
- Test duration: 1-60 s
- Operating time: 5-10 ms
- Impulse frequency range: 1-10 Hz

PWM device control:

- Number of outlets: 1
- Test duration: 1-60 min
- Automatic or manual
- Duty cycle adjustment: 10%-85%
- Signal frequency regulation: 120-250 Hz

1895G	€ 1.745,00	1	018950800
-------	---------------	---	-----------

1895/S

adjustable support for ultrasonic cleaning tanks 1895

Allows injectors to be correctly placed during washing in ultrasonic cleaning tank

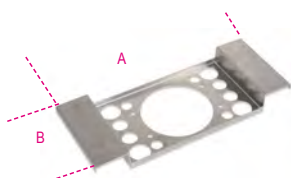

1895/S	A mm 340	B mm 140	€ 103,50	1	018950501
--------	-------------	-------------	-------------	---	-----------

1895 6

ultrasonic cleaning tank,
6 l

with special degas function



Features:

- Ultrasonic cleaning relies on fluid heating to effectively clean spare parts and metal pieces in general (injectors, carburetors, valves etc.)
- Digital display for temperature and cleaning time selection
- Two cleaning modes: "soft" and "normal"
- For normal cleaning, just use water at a temperature of 50/60 °C
- For more accurate cleaning, add non-foaming detergent specific for ultrasonic tanks
- Using the degas mode speeds up air release throughout the tank, thereby improving ultrasonic cleaning efficiency

Technical Data

- Tank capacity: 6 l
- Drain tap
- Power: 150 W
- Heating power: 300 W
- Temperature range: 0+80 °C
- Cleaning time range: 0-99 minutes
- Frequency: 40 kHz
- Power supply: 220/230V
- Overall dimensions: 330x180x310 mm
- Tank dimensions: 300x155x150 mm
- Basket dimensions: 250x105x100 mm
- Maximum capacity: 5.5 kg

1895 6	Max 5,5	€ 673,00	1	018950060
--------	------------	-------------	---	-----------

1895 13

ultrasonic cleaning tank,
13 l

with special degas function



Features:

- Ultrasonic cleaning relies on fluid heating to effectively clean spare parts and metal pieces in general (injectors, carburetors, valves etc.)
- Digital display for temperature and cleaning time selection
- Two cleaning modes: "soft" and "normal"
- For normal cleaning, just use water at a temperature of 50/60 °C
- For more accurate cleaning, add non-foaming detergent specific for ultrasonic tanks
- Using the degas mode speeds up air release throughout the tank, thereby improving ultrasonic cleaning efficiency

Technical Data:

- Tank capacity: 13 l
- Drain tap
- Power: 300 W
- Heating power: 400 W
- Temperature range: 0+80 °C
- Cleaning time range: 0-99 minutes
- Frequency: 40 kHz
- Power supply: 220/230V
- Overall dimensions: 350x325x320 mm
- Tank dimensions: 325x235x145 mm
- Basket dimensions: 257x185x100 mm
- Maximum capacity: 12 kg

1895 13	Max 12	€ 1.044,00	1	018950130
---------	-----------	---------------	---	-----------

1895 27

ultrasonic cleaning tank,
27 l

with special degas function



Features:

- Ultrasonic cleaning relies on fluid heating to effectively clean spare parts and metal pieces in general (carburetors, valves etc.)
- Digital display for temperature and cleaning time selection
- Two cleaning modes: "soft" and "normal"
- For normal cleaning, just use water at a temperature of 50/60 °C
- For more accurate cleaning, add non-foaming detergent solutions specific for ultrasonic tanks
- Using the degas mode speeds up air release throughout the tank, thereby improving ultrasonic cleaning efficiency

Technical Data:

- Tank capacity: 27 l
- Drain tap
- Power: 500 W
- Heating power: 500 W
- Temperature range: 0+80 °C
- Cleaning time range: 0-99 minutes
- Frequency: 40 kHz
- Power supply: 220/230V
- Dimensions: 530x330x380 mm

1895 27	Max 25	€ 1.455,00	1	018950270
---------	-----------	---------------	---	-----------

1895/RC

rack for ultrasonic tanks 1895



	L mm	L1 mm	A mm	€		
1895/RC6	250	105	100	43,00	1	018950506
1895/RC13	257	185	100	67,50	1	018950513
1895/RC27	450	250	150	113,50	1	018950527



1897

professional bench sander

Particularly recommended for surface finishing jobs on several materials (metal, plastic, glass, ceramic, wood etc.). The cabin is made from properly reinforced sheet steel which results in unparalleled sturdiness and firmness.

The cabin is equipped with the following:

- loading door with magnet closure
- perforated sheet metal top
- standard connection for vacuum cleaners, \varnothing 36 mm
- protective polycarbonate viewing window, 6 mm
- LED lamp
- pneumatic circuit (compressed air inlet)
- sanding gun with trigger operation



CE

TECHNICAL DATA

Useful dimensions of cabin: 600x520x320 mm

Overall dimensions: 660x530x500 mm

Weight: 38 kg

Worktop: perforated sheet metal

Lighting: LED

Air consumption: 340 l/min at 7 atm

Power supply: 220 V - 50 Hz

1897 € 3.240,00 1 018970066

1897/CRB

corundum for sander 1897 in 25 kg bag



1897/CRB € 162,50 1 018970101

1897/G

garnet for sander 1897 in 25 kg bag



1897/G € 130,50 1 018970104

1897/MV

glass microspheres for sander 1897 in 25 kg bag



1897/MV € 214,50 1 018970103

1898/K40

Eco friendly, heated manual cleaning tank

- Using the bio-active liquid included, oil and residue can be effectively removed from mechanical parts without the need for aggressive chemicals
- The bio-active liquid converts the oil and other residue into carbon dioxide and water which can be re-used again and again
- no need for specialist waste collection and disposal
- suitable for both metal and plastic parts



CE

Equipment:

- Long bristle brush and connecting pipe
- Right-hand and left-hand operation function
- Perforated stainless steel grid
- Wheels with brakes
- Card with display operating temperature and low level alert

Accessories Included:

- 2 20 l cans of environmentally friendly liquid detergent and 2 packs of bacteria
- 2 packs of bio-active liquid

Technical data:

- Max. pump capacity: 10 li/min
- Tank capacity: 40 l
- Operating temperature: +5 °C ÷ +40°C
- Dimensions: 900 x 1000 x 750 mm
- Weight: 50 kg (when empty)

Attention:

Countries where product 1898/K40 is allowed to be distributed: Austria, Belgium, France, Hungary, Italy, Netherlands, Poland, Portugal, Spain, United Kingdom.

1898/K40 € 4.300,00 1 018980004

ATTENTION

Countries where product 1898/K40 is allowed to be distributed: Austria, Belgium, France (from 2021), Hungary, Italy, Netherlands, Poland, Portugal, Spain, United Kingdom.

1898/B

bottle of bacteria, 400 ml, for part cleaning tank 1898/K40



1898/B € 88,50 1 018980904

CAUTION: Countries where item 1898/B is allowed to be distributed: Austria, Belgium, France, Italy, Netherlands, Portugal, United Kingdom, Spain, Hungary

1898/D

tank of environmentally friendly detergent liquid, 20 l, for part cleaning tank 1898/K40



1898/D € 176,00 1 018980920

CAUTION:

Countries where item 1898/B is allowed to be distributed: Austria, Belgium, France, Italy, Netherlands, Portugal, United Kingdom, Spain, Hungary

1899A

DPF/FAP® system cleaning machine

Special detergents can be used to periodically clean and restore DPF and FAP® systems damaged by soot and ash deposits.



CE

Supplied with:

- 1 2-m-long feed pipe
- 1 quick coupler + hose nozzle for differential sensor hoses
- 1 niple M18x1.5 with hose nozzle for direct connection to lambda probe
- 1 extension hose
- 1 DPF/FAP® spray nozzle
- 1 magnetic pipe support
- 1 DPF/FAP® pipe with adjustment cable gland plus niple M14/16/18 mm for connecting lambda probes

Technical specifications:

- operating voltage: 12 V
- power supply cord length: 3.9 m
- tank capacity: 1 l

1899A € 1.173,00 1 018990010



2250-O

heavy duty swivel creeper seat with tray



2250-O	€ 101,00	1	022500011
--------	----------	---	-----------

2251-O

heavy duty swivel creeper seat with drawers



2251-O	€ 174,50	1	022510011
--------	----------	---	-----------

2252

seat with castors

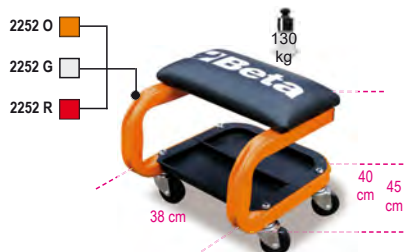

2252-O	€ 169,50	1	022520001
2252-G	€ 169,50	1	022520002
2252-R	€ 169,50	1	022520003

2252KR4

spare seat castors 2252



2252KR4	€ 57,50	1	022520900
---------	---------	---	-----------

2258-O

heavy duty creeper with tool chest



2258-O	€ 176,00	1	022580011
--------	----------	---	-----------

2254A

car covers, for outdoor use, water-repellent and UV-resistant

These covers are ideal for protecting damaged vehicles while waiting to be repaired

Technical specifications

- exterior finish with UV protection treatment
- soft, nonscratch interior finish
- 6 adjustment strings for making cover fit close to car
- 2 front door zips to allow access to vehicle without having to remove cover
- mirror seats
- reflecting



3 versions:

- size M recommended for compact cars
- size L recommended for saloon cars and station wagons
- size XL recommended for SUVs

	LxPxH mm	€	1	
/M	4400x1450 x1300	143,50	1	022540002
/L	5300x1450x1150	160,50	1	022540000
/XL	4700x1450x1580	147,00	1	022540001

2254C

suction cup protector for vehicles' bodies

Made of plastic-coated fabric, with 4 suction cups on top side



2254C	L1 mm 1150	L2 mm 650	€ 46,50	1	022540200
-------	---------------	--------------	---------	---	-----------

2254F

car front protector

Allows front part of vehicle to be protected, while leaving openings for headlights and radiator



- Waterproof
- Resistant to oil and grease
- Strap fixing
- Material: 98% polyamide/nylon, 2% polyurethane

2254F	€ 80,00	1	022540150
-------	---------	---	-----------

2254K

reusable seat, steering wheel and gear knob protector

Suits most car seats, steering wheels and gear knobs



2254K	€ 27,50	1	022540101
-------	---------	---	-----------

2254SM

creeper mat, made of EVA

Double finish:

- 1 side in soft EVA
- 1 side in hard carbon look for improved slip performance



2254SM	€ 63,50	1	022540033
--------	---------	---	-----------



2254T

knéeing pad

made from non-slip EVA foam



2254T € 28,00 1 022540047

3000M/LT

creeper

• PVC lining with upholstered foamed rubber designed for remarkable comfort

ADJUSTABLE HEAD-REST BY PROGRESSIVE AIR SPRING

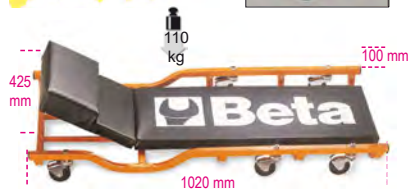

3000M/LT € 162,50 1 030000220
7,3 kg

3000M/RLS

spare creeper castors



3000M/RLS € 11,80 1 030000206

3002

creeper and seat

• Steel frame
• PVC lining with upholstery
• Easily convertible into a creeper or a seat



NOT AVAILABLE IN THE USA, CANADA AND MEXICO

3002 € 107,50 1 030020001

3002/RLS

6 spare wheels for creeper 3002



3002/RLS € 28,00 1 030020501

3003

creeper

made of shockproof plastic

• Wheel Ø: 76 mm



3003 € 84,00 1 030030001

3003/RLS

6 spare wheels for creeper 3003



3003/RLS € 44,00 1 030030501

3003C

creeper made of shockproof plastic

Complete with:
- head and lumbar region with carbon look finish
- upper metal plates for fixing magnetic accessories
- 6 rubber castors, 79 mm in diameter
- Max. capacity: 120 kg
- Weight: 5.5 kg



3003C € 226,00 1 030030100

3003C/RLS

6 spare wheels for creeper 3003C



3003C/RLS € 91,00 1 030030600

3003PRO

creeper made of shockproof plastic

Complete with:
- ergonomic head cushion
- soft back protector
- 2 178 mm double bearing castors for trouble-free use on uneven surfaces and pipes/cables
- 1 castor
- double height adjustment from the ground: 38 or 76 mm
- 2 portable LED lamps (250 lumens) with fixing magnets
- load capacity: 200 kg
- weight: 7.7 kg



C max kg 200 H min mm 170 H Max mm 230 H1 mm 230 € 318,00 1 030030150

3003PRO/SP

wall-mounted plastic support for creeper 3003PRO

can be mounted to walls, bridge jacks, chests of drawers or other equipment, thereby allowing creeper to be fixed through a quick system with safety closure.

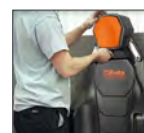

3003PRO/SP € 85,00 1 030030151

3003PRO/PM

magnetic tool holder, round, for creeper item 3003PRO

can be applied to wheel rims of creeper to retain small items during jobs



3003PRO/PM € 9,10 1 030030152

3003PRO/RCR

spare rear wheels for creeper 3003PRO, pair



3003PRO/RCR € 67,50 1 030030650

3003PRO/RRG

spare front castor for creeper 3003PRO



3003PRO/RRG € 21,00 1 030030651

3003PRO/RT

LED inspection lamp with spare magnets for creeper 3003PRO

- 250 lumens
- Batteries: 4xAAA (not included)



3003PRO/RT € 15,30 1 030030652

3006

jack and positioner for tractor and excavator wheels

- max. capacity: 1,500 kg
- min. wheel diameter: 1,000 mm
- max. wheel diameter: 2,200 mm
- max. wheel thickness: 800 mm

CE



3006 € 1.675,00 1 030060000

3006 R/RGF

spare castor with brake for wheel jack and positioner 3006



3006 R/RGF € 64,50 1 030060501

3006 R/RG

spare castor for wheel jack and positioner 3006



3006 R/RG € 56,00 1 030060502

3007

underbody trolley for vehicles without forecarriage / rear axle

- Allows vehicles without forecarriage or rear axle to be easily handled while working
- 4 pivoting wheels, including 2 with brakes, suitable for use in painting furnaces
 - 2 sliding supports to fit all chassis
 - max. capacity: 800 kg

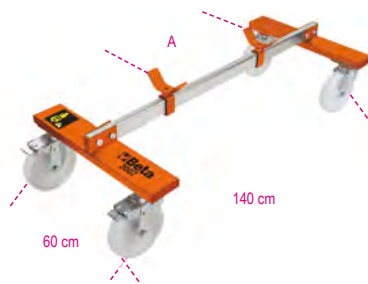

3007 € 566,00 1 030070001

3007 R/RGF

spare castor with brake for vehicle underbody trolley 3007



3007 R/RGF € 96,00 1 030070501

3007 R/RG

spare castor for vehicle underbody 3007



3007 R/RG € 84,00 1 030070502

3008

jack and positioner for single and twin truck wheels

- max. capacity: 700 kg
- min. height: 140 mm
- max. height: 660 mm
- distance between rollers: 470÷740 mm
- hydraulic overloading safety device
- front pivoting wheels

CE



3008 € 2.900,00 1 030080100

3009

wheel lifter

- Maximum lifting capacity: 550 kg
4 pivoting rollers
Roller width: 200 mm
For wheels up to 240 mm in width



3009 € 403,00 1 030090001

3009R/GR4

4-wheel groups for trolleys 3009 R/GR4



3009R/GR4 € 164,50 1 030090501

3010/T...

jack stands, pair



C max	H min	H max	H1	L	L1
kg	mm	mm	mm	mm	mm
2000	280	425	245	185	165

3010T 2 € 95,00 1 030100002

C max	H min	H max	H1	L	L1
kg	mm	mm	mm	mm	mm
3000	285	430	250	180	195

3010T 3 € 112,50 1 030100003

C max	H min	H max	H1	L	L1
kg	mm	mm	mm	mm	mm
6000	400	580	340	245	280

3010T 6 € 163,50 1 030100006

C max	H min	H max	H1	L	L1
kg	mm	mm	mm	mm	mm
10000	471	735	420	330	290

3010T 10 € 282,00 1 030100010

3011/T

hydraulic bottle jacks



C max	H min	H Max	L
kg	mm	mm	mm
3500	170	366	86

3011T 3,5 € 95,00 1 030110035

C max	H min	H Max	L
kg	mm	mm	mm
5000	203	467	118

3011T 5 € 106,50 1 030110050

C max	H min	H Max	L
kg	mm	mm	mm
10000	220	484	114

3011T 10 € 159,00 1 030110100

C max	H min	H Max	L
kg	mm	mm	mm
15000	230	497	113

3011T 15 € 195,50 1 030110150

C max	H min	H Max	L
kg	mm	mm	mm
20.000	245	521	115

3011T 20 € 280,00 1 030110200

3010H

heavy-duty jack stands



C Max	H min	H Max	L	L1
kg	mm	mm	mm	mm
15,000	450	750	300	300

3010H 750 € 305,00 1 030100150

C Max	H min	H Max	L	L1
kg	mm	mm	mm	mm
15,000	650	1100	300	300

3010H 1100 € 382,00 1 030100165

3010V

heavy-duty jack stands,
screw adjustable



C Max	H min	H Max	L	L1
kg	mm	mm	mm	mm
20,000	470	680	300	300

3010V 680 € 444,00 1 030100200

C Max	H min	H Max	L	L1
kg	mm	mm	mm	mm
20,000	680	1170	300	300

3010V 1170 € 564,00 1 030100220

3012

engine brackets



L	C max	€	1	030120010
mm	kg			
1500	500	290,00	1	030120010
1800	400	393,00	1	030120018

3012C

lower engine bracket

ideal for cars and commercial vehicles



3012C € 766,00 1 030120255

3012I

lower engine bracket

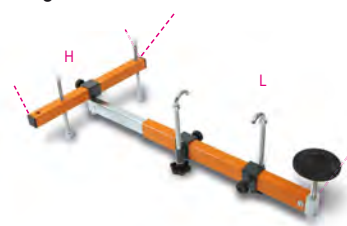

L	H	€	1	030120250
mm	mm			
630±960	190	679,00	1	030120250

3014

engine stand



3014 € 365,00 1 030140010

3014R/GR5

5 spare wheels for engine stand 3014



3014R/GR5 € 91,50 1 030140501

3014 SAR

folding engine stand

- Easy to fold up, for significantly increased compactness
 - Allows 360° rotation of engine or gear
 - Provides unparalleled safety and stability during jobs
- Maximum capacity: 450 kg



3014SAR € 1.335,00 1 030140360

3014SAR/RR

4 spare wheels for engine stand 3014SAR



3014SAR/RR € 146,50 1 030140370

3014SAR/1

fluid collection tank
for item 3014 SAR

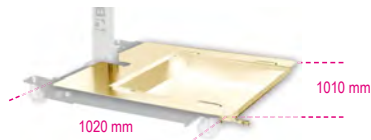

3014SAR/1	392,00	1	030140361
1020x1010x11 mm			

3014SAR/2

clamp for fixing transmission gear on stand
item 3014 SAR

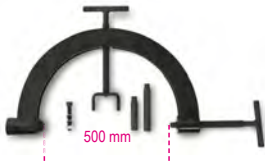

3014SAR/2	378,00	1	030140362
-----------	--------	---	-----------

3023

pit and under bridge jack
with screw adjustment
maximum carrying capacity: 400 kg



3023	201,50	1	030230050
H min-Max mm 1350=2030, Ø mm 300			

3025

folding hydraulic crane with dual effect pump

Maximum capacity: 1 t

CE



3025	3025	1.815,00	1	030250001
------	------	----------	---	-----------

3025/RF

2 spare fixed wheels for hydraulic crane 3025



3025/RF	232,00	1	030250901
---------	--------	---	-----------

3025/RG

2 spare swivel wheels for hydraulic crane 3025



3025/RG	340,00	1	030250902
---------	--------	---	-----------

3025/PF

barrel handling pliers

Maximum capacity: 300 kg

CE



3025/PF	A mm 550+640, B mm 70	289,00	1	030250011
---------	-----------------------	--------	---	-----------

3026 0,3

hydraulic pit and under bridge jack

CE



3026 0,3	664,00	1	030260003
----------	--------	---	-----------

3026/R0,3

4 spare swivel wheels for hydraulic jack 3026 0,3



3026/R 0,3	168,00	1	030260903
------------	--------	---	-----------

3026 0,5

hydraulic pit and under bridge jack

Maximum capacity: 500 kg

CE



3026 0,5	790,00	1	030260005
----------	--------	---	-----------

3026/R0,5

4 spare swivel wheels for hydraulic jack 3026 0,5



3026/R 0,5	247,00	1	030260905
------------	--------	---	-----------

3026 1,0

hydraulic pit and under bridge jack

Maximum capacity: 1 t

CE



3026 1,0	953,00	1	030260010
----------	--------	---	-----------

3026/R 1,0

4 spare swivel wheels for hydraulic jack item 3026 1,0



3026/R 1,0 € 300,00 1 030260910

3026/S

swivel transmission gear support with reduction bushes for jacks item 3026

Maximum capacity: 500 kg



3026/S € 556,00 1 030260501

3026/SP

universal transmission support

Allows one operator to disassemble and reassemble any transmissions of cars, commercial vehicles and off-rovers quickly and safely.



3026/SP € 647,00 1 030260505

3026/SA

wheel hub support for pit jacks

- for use for maintenance jobs relating to hubs, and during shock absorber replacement jobs
- can be adapted to hydraulic pit jacks items 3026 0,3 and 3026 0,5



3026/SA 30,4 mm € 135,00 1 030260510

3026/SAM

shock absorber support for pit jacks

- for use for supporting shock absorber when suspension arm is removed
- shock absorber bracket, max. diameter 80 mm, plus adapter for max. diameters 60 mm
- can be adapted to hydraulic pit jacks items 3026 0.3 and 3026 0.5



3026/SAM € 174,50 1 030260515

3027 10

hydraulic bench press with moving piston

Maximum capacity: 10 t

CE



3027 10 € 1.600,00 1 030270010

90 kg

3027 20

hydraulic press with moving piston 20 t

Maximum capacity: 20 t

CE



3027 20 € 2.220,00 1 030270020

3027 30

hydraulic press with moving piston and hoist

Maximum capacity: 30 t

CE



3027 30 € 3.870,00 1 030270030

3027 50

hydraulic press with moving piston and hoist

Maximum capacity: 50 t

CE



3027 50 € 5.290,00 1 030270050



3027 100

motorized electro-hydraulic press with moving piston

technical specifications:

- maximum capacity: 100 t
- power supply: 380 V (three-phase)
- frequency: 50 Hz
- electric motor power: 1.5 kW
- double speed control unit
- operated by a lever distributor
- pallet lifting by means of chains

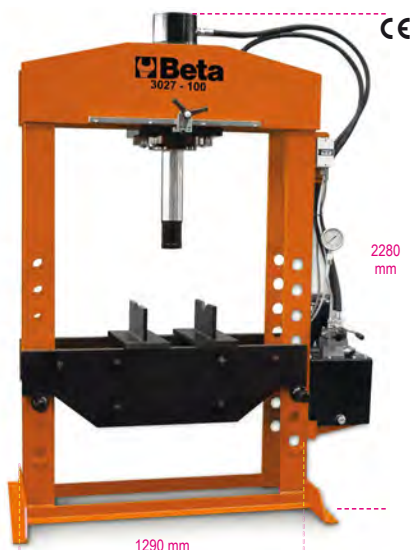

- For transportation safety reasons, the press is sold without oil (Eni OSO 46 - ESSO NUTO 46 or equivalent oils).
- Power supply cord is not included.

3027 100 € 13.830,00 1 030270100

3027/KP

set of pin punches and plate for press item 3027



		€		
3027/KP10	3027 10	358,00	1	030270510
3027/KP20	3027 20	477,00	1	030270520
3027/KP30	3027 30	477,00	1	030270530
3027/KP50	3027 50	562,00	1	030270550
3027/KP100	3027 100	1.008,00	1	030270551

3027/KPP50

pedal control for hydraulic press item 3027 20-30-50



3027/KPP50 € 237,00 1 030270555

3027/PR

press supporting tool for removal/insertion of hubs, bearings and silent blocks

Universal system which allows user to mount/dismount hubs, bearings and silent blocks into/from their housings by operating under a press, through a supporting base and its accessories. Tool can adapt to irregular geometric shapes of hubs/king pins on which operator must work.



Technical Data:

- Working range: min. 130 mm - max. 186 mm
- Dimensions: 300 x 300 mm
- Weight: 13 kg
- Max. load-bearing capacity: 20 t

3027/PR € 594,00 1 030270400

3029/2T

lowered hydraulic jack, 2 t, with 4 wheels

- Quick approach pedal
- Steel frame and nylon wheels
- Minimum height: 75 mm

CE



3029/2T € 392,00 1 030290020

3029L/2T

long, lowered jack, 2 t

Makes it possible to work on vehicles with reduced height from the ground and internal lifting point

- Controlled descent speed
- Quick approach pedal
- Nylon wheels

CE



3029L/2T € 454,00 1 030290120

3029/2T-L/RP

spare 85-mm rubber plate for items 3029/2T and 3029L/2T



3029/2T-L/RP € 15,30 1 030290502

3029/2T-L/R6

spare rear wheel for items 3029/2T and 3029L/2T



3029/2T-L/R6 € 50,00 1 030290506

3029/2T-L/R5

spare front wheel for jacks item 3029/2T and item 3029L/2T



3029/2T-L/R5 € 46,00 1 030290505

3030/2T

lowered car jack, 2 t with 6 wheels

- dual front tilting wheels made of plastic material (PTFE)
- car jack can be easily handled on uneven, irregular floors
- maximum capacity: 2 tons

CE



3030/2T € 761,00 1 030300020

43 kg

3030/2T-R5

front wheel with pin for jack 3030 2T



3030 2T/R5 € 26,50 1 030300505

3030/2T-R6

spare rear wheel for item 3030/2T



3030 2T/R6 € 41,50 1 030300506

3030/2TRP

spare 85-mm rubber plate for item 3030/2T



3030/2TRP € 5,40 5 030300501

3030H/2T

high-lift hydraulic jack, 2 t, with 6 wheels

makes it possible to work on vehicles that are high from the ground and have a long shock absorber travel • controlled descent speed

- quick approach pedal
- nylon wheels

CE



H min-Max mm	L mm	L1 mm	€	1	030300220
85-780	1010	300	637,00	1	030300220

3033/3T

hydraulic jack, 3t long version

- For use on commercial vehicles
- Maximum capacity: 3 t
- Polyamide wheels

CE



3033/3T € 987,00 1 030330030

3033E/3T

hydraulic jack, 3 t

- controlled descent speed
- nylon wheels

CE



H min-Max mm	L mm	L1 mm	€	1	030330130
95-515	700	370	373,00	1	030330130

3033S 3T/R2

spare front wheel for jack 3033E/3T



3033S 3T/R2 € 43,00 1 030330532

3035

tyre trolley

- 2 castors Ø 260 mm
- 2 castors Ø 125 mm
- Maximum carrying capacity: 200 kg
- Forks can be adjusted in 2 positions: first position: maximum opening 880 mm second position: maximum opening 980 mm
- Can be used as a top by locking position horizontally



3035 € 917,00 1 030350100

3036

wheel handling base

Non-marking rubber castors



3036 € 108,50 1 030360063

3061/2T

air hydraulic jack, 2 tons - 2 stages

CE



Fitted with:

- high-resistance three-layer diaphragm and internal telescopic guide
- end-of-stroke stop and overloading safety valve
- can also be used on auto lifts

TECHNICAL DATA

capacity: 2 t
weight: 14 kg
power supply pressure: 8-10 bar
height: min.132 - max. 326 mm

3061/2T € 852,00 1 030610020

3061/2T-P50

50-mm extension for item 3061/2T



3061/2T P50 € 72,50 1 030610021

3061/2T-P100

100-mm extension for item 3061/2T



3061/2T P100 € 97,00 1 030610022

3065/20-10T

air hydraulic jack, 20-10 t,
with case

Portable and lightweight, ideal for road assistance operations

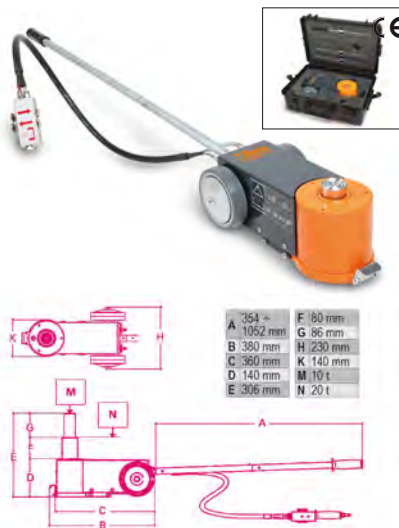

- Supplied with two extensions, 75 and 60 mm long

TECHNICAL DATA

capacity: 20-10 t
weight: 23 kg
power supply pressure: 8-10 bar
air consumption: 400 nl/min

3065/20-10T € 2.510,00 1 030650100

3065/40-20T

air hydraulic jack, 40/20 tons

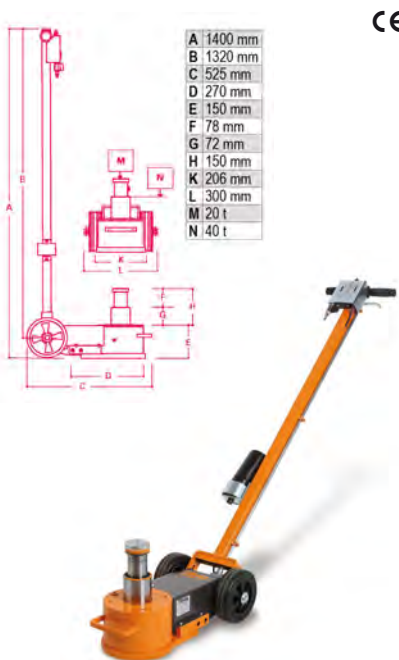

- suitable for use on heavy vehicles
- functional and easy to handle, for transportation on mobile repair shops as well
- automatic piston return
- two descent valves with under load speed control

TECHNICAL DATA

capacity: 40/20 tons
weight: 39 kg
power supply pressure: 8-10 bar
air consumption: 400 l/min

3065/40 20T € 2.860,00 1 030650200

3067/60-15T

air hydraulic jack, 60-30-15 t

With a minimum height of no more than 120 mm,
it is particularly suitable for use on buses, coaches and public
means of transport

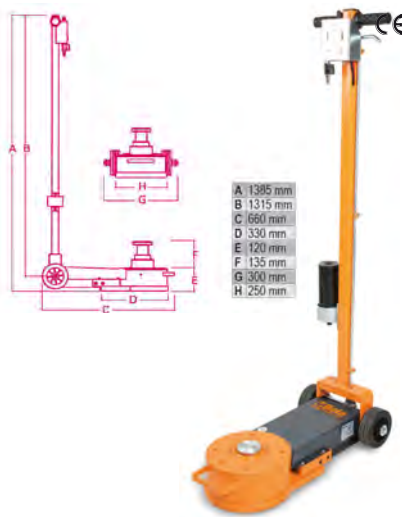

- Automatic piston return
- Two descent valves with under load speed control
- supplied with two extensions, 70 and 120 mm long

TECHNICAL DATA

capacity: 60-30-15 t
weight: 56 kg
power supply pressure: 8-10 bar
air consumption: 600 l/min

3067/60-30-15T € 4.170,00 1 030670120

3067/70-13T

air hydraulic jack, 70-43-23-13 t

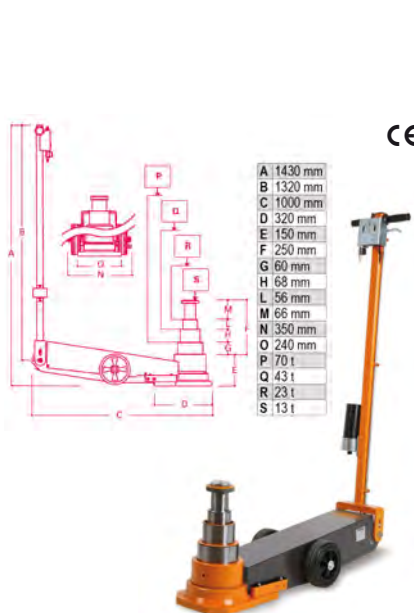

- Long version, suitable for use on lorries, articulated vehicles, buses and coaches, and agricultural machines
- automatic piston return
- two descent valves with under load speed control

TECHNICAL DATA

capacity: 70-43-23-13 tons
weight: 74 kg
power supply pressure: 8-10 bar
air consumption: 600 l/min

3067/70 13T € 5.260,00 1 030670130

Beta



MOTORCYCLE TOOLS

Beta's products are synonymous with unparalleled quality and reliability, as the result of eighty years of experience and tradition.

Our products are regularly updated, their quality being highly appreciated by the engineers and mechanics of the best racing teams in the Road Racing World Championship Grand Prix, Superbike World Championship, Motocross World Championship and World Enduro Championship.



3040C

rear motorcycle stand, adjustable

- Matt black lacquer
- 4 thermoplastic rubber wheels
- Includes V-shaped sliders, pair
- Includes L-shaped sliders, pair



3040C € 74,00 1 030400002

3040C/S1

V-shaped sliders, pair, for item 3040C



3040C/S1 € 11,60 1 030400503

3040C/S2

rubber L-shaped sliders, pair, for item 3040C



3040C/S2 € 16,90 1 030400504

3041C

front motorcycle stand, adjustable

- Matt black lacquer
- 4 thermoplastic rubber wheels
- Includes roller sliders, pair
- Includes cone-shaped sliders, pair



3041C € 69,00 1 030410002

3041C/12

roller sliders, pair, for item 3041C



3041C/12 € 16,30 1 030410512

3041C/16

cone-shaped sliders, for item 3041C



3041C/16 € 11,10 1 030410516

3042C

front stand for motorcycle steering pin

- Matt black lacquer
- 4 thermoplastic rubber wheels
- Includes 8-pin kit Ø 13 - 15 - 15.5 - 17 - 19 - 20 - 21 - 27



3042C € 124,50 1 030420002

3043C

motorcycle stand with left single arm

- Matt black lacquer
- 4 thermoplastic rubber wheels
- Optional pin



3043C € 91,00 1 030430002

3043C/ 41÷47

pin for item 3043C



	Ø mm	€		
3043C/41 Ducati	21,5 ÷ 25,5	20,80	1	030430551
3043C/42 KTM - Triumph	27,5	20,80	1	030430552
3043C/43 MV	42,5	22,50	1	030430553
3043C/44 Ducati	40,5	22,50	1	030430554
3043C/45 Honda	28,5	20,80	1	030430555
3043C/47 BMW	53,5	26,50	1	030430557

3047C

pedal stand for cross/enduro motorcycles



3047C € 57,50 1 030470002

3048C

Steel racing cross stand

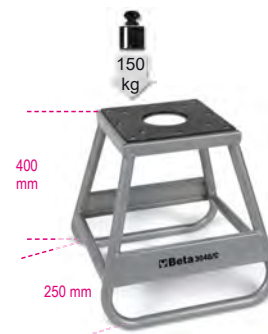

3048C € 57,50 1 030480002

3050/CC

chock cradle centre stand for Custom, Enduro, Cross, Scooter motorcycles includes adjustable support kit



3050/CC € 148,00 1 030500012

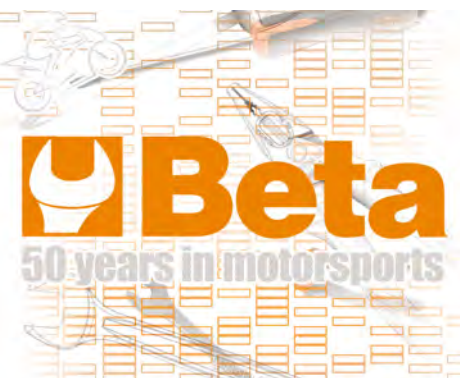

3050/600

electro-hydraulic motorcycle jack,
600 kg



CE

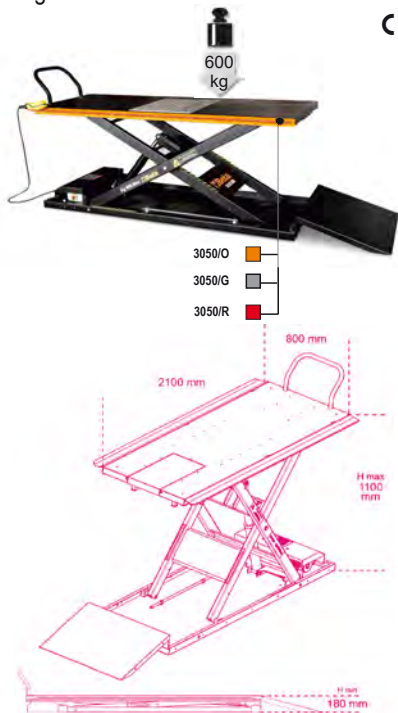

Technical specifications:

- Electrical, mechanical and hydraulic safety devices
- Capacity: 600 kg
- Integrated electro-hydraulic unit: 230V - 50 Hz
- Hydraulic pump
- Controlled downward speed
- Safety fuses for protection in case of cable cuts
- Control push button panel
- CE-certified, TÜV-approved

	L	L	H min	H Max	€		
	mm	mm	mm	mm			
3050/O	975	2100	185	1110	4.990,00	1	030500201
3050/G	975	2100	185	1110	4.990,00	1	030500202
3050/R	975	2100	185	1110	4.990,00	1	030500203

3050/KA

widening kit for jack item 3050/600

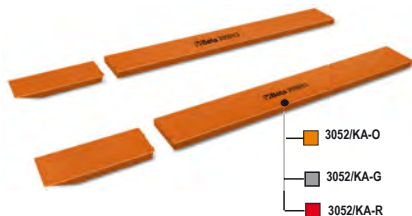

	A	B	€		
	mm	mm			
3050/KA-O	107,5	2100	1.000,00	1	030500221
3050/KA-G	107,5	2100	1.000,00	1	030500222
3050/KA-R	107,5	2100	1.000,00	1	030500223

3050/MS

wheel clamp for jack item 3050/600



allows motorcycle front wheel to be locked to bridge



3050/MS	€ 568,00	1	030500032
---------	----------	---	-----------

3050/MV

mechanical screw wheel clamp
for jack 3050/600



3050/MV	€ 948,00	1	030500034
---------	----------	---	-----------

3050/LA

non-slip sheet metal top
for jack item 3050/600

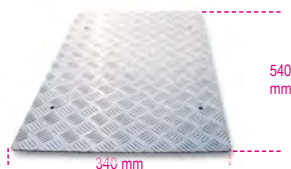

3050/LA	€ 102,50	1	030500062
---------	----------	---	-----------

9562T1

garage mat, 100X80 cm



particularly suitable for use under motorcycle tyre levers
BETA 3071 and 3071B
• easy to clean, anti-skid rubber coated bottom

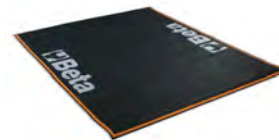

9562T1	€ 80,00	1	095620150
--------	---------	---	-----------

9562T3

garage mat, 300x160 cm



- particularly suitable for use under motorcycle jacks

- protects floor from oil and petrol leaks, environmentally friendly
- easy to clean, anti-skid, rubber-coated bottom



9562T3	€ 317,00	1	095620300
--------	----------	---	-----------

3054

moving base for central stand or motorcycle
rear wheel
with extension for side stand



3054	€ 246,50	1	030540000
------	----------	---	-----------

3055M

automatic van clamp



Allows motorcycle front wheel
to be fixed



3055M	€ 94,50	1	030550002
-------	---------	---	-----------

Beta

3057

aluminium ramp for loading/unloading motorcycles

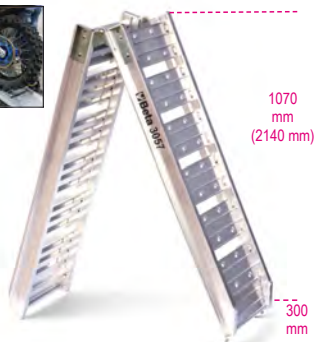

3057	€ 200,50	1	030570001
------	----------	---	-----------

3070B

manual static balancer



- Allows wheel balancing both in the workshop and on racing tracks
- Equipped with rolling bearings, rabbet level and adjustable feet for unparalleled precision
- Comes with 2 hub cones

3070B	€ 120,00	1	030700100
-------	----------	---	-----------

3070B/...

balancing rod for balancer 3070B



	Ø1	Ø2	€		
3070B/10	30	10	21,40	1	030700101
3070B/12	30	12	25,50	1	030700102
3070B/14	40	14	31,00	1	030700103

3070BE/K

electronic hand-spin wheel balancer, portable



balancing system with hand-spin microprocessor (without motor), for balancing iron or alloy car and motorcycle wheels



CE



Features:

- Compact and easy to carry, for use in garages, trucks or track pits
- Can be mounted to a workbench or a wall
- Software includes all unbalance correction programmes, reading of positions with adhesive weights (ALUS), weights hidden behind spokes (SPLIT) and unbalance optimization
- Can be used with swivel support BETA 3070BE/S (optional)

Accessories supplied with wheel balancer:

- Flexible graduated ruler
- Ring nut with handwheel and 3 cones Ø 45 ÷ 110 mm

Technical data:

- Power supply: 115-230V AC o 12-24V DC
- Max. absorbed power: 0.15 kW
- Balancing speed: 100 rpm
- Measurement uncertainty: 1 g
- Rim width: 1.5" ÷ 20" (40 ÷ 510 mm)
- Max. weight wheel: 75 kg

3070BE/K	€ 3.020,00	1	030700250
----------	------------	---	-----------

3070BE/S

swivel support for portable electronic wheel balancer item 3070BE



allows wheel balancer to be fixed to a wall or a workbench, thereby resulting in reduced installation space



	L	L1	€		
	mm	mm			
3070BE/S	514	280	1.101,00	1	030700201

3070BE/F

universal motorcycle flange, Ø 40 mm, for item 3070BE



for use on wheels with central through-holes, Ø 15 ÷ 35 mm, and on flanged wheels with truing up to Ø 68 mm



3070BE/F	€ 1.500,00	1	030700202
----------	------------	---	-----------

3070BE/B

kit of 8 motorcycle wheel truing sockets for item 3070BE



Designed to work on following diameters:
28 - 25 - 22 - 20 - 19.05 - 17 - 16 - 15



3070BE/B	€ 1.675,00	1	030700203
----------	------------	---	-----------

3071A

manual tyre lever for cross and enduro motorcycles



Allows easy and quick tyre removal in racing fields; based on sturdy, wide frame made of galvanized steel, it provides firmness during tyre removal. Can be installed on BETA 3071RS bracket, for increased convenience

Features:

- Ergonomic rubber handle, for easy, safe lever hold
- With rubber retainer for locking rod during transportation
- Can be used to install cross and enduro tyres, 17" ÷ 21".

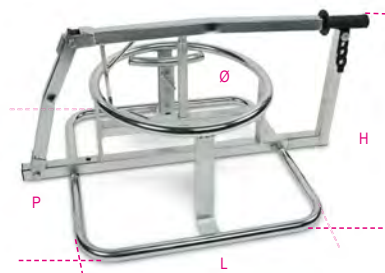

	L	H	P	Ø	€		
	mm	mm	mm	mm			
3071A	570	400	850	440	464,00	1	030710000

3071B

manual tyre lever for mini bikes and mini dirt bikes

Allows easy and quick tyre removal in racing fields; based on sturdy, wide frame made of galvanized steel, it provides firmness during tyre removal. Can be installed on BETA 3071RS bracket, for increased convenience

Features:

- Ergonomic rubber handle, for easy, safe lever hold
- Can be used to install most mini bike and mini dirty bike tyres.

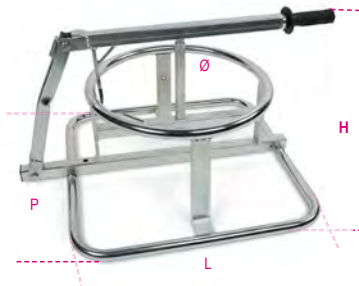

L	H	P	Ø	€	1	030710010
mm	mm	mm	mm			
3071B	570	330	650	433,00		

3071RS

bracket for BETA 3071A and 3071B tyre levers

Used to elevate BETA 3071A and 3071B tyre levers, making tyre removal easier; frame made from galvanized steel, with square base for increased firmness.

- With 4 fixing hooks

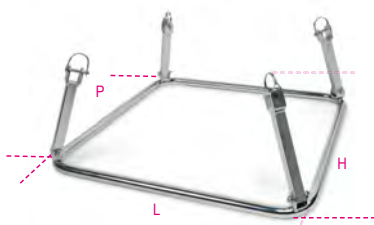

L	H	P	€	1	030710020	
mm	mm	mm				
3071RS	670	275	670	202,00		

962C

tyre levers, pair, for cross and enduro motorcycles, mini bikes and mini dirty bikes for use in combination with BETA 3071A and 3071B



L	A	€	1	009620020	
mm	mm				
962C	420	30	107,00		

3072N

workbench rear motorcycle shock absorber dismantler, manual

Allows totally safe motorcycle rear shock absorber dismantling; based on its adjustable arms, it suits most rear shock absorbers; alternatively, it can be used with the supplied plate.

- optional locking rings

Features

- Suitable for use on most motorcycle rear shock absorbers
- Vertically adjustable in 8 positions
- 3 adjustable arms with vertically adjustable retainers
- shock absorber locking plate
- with pantograph jack
- with rubber feet
- with shock absorber lock pin

Technical data

Jack extension: max. 130 mm
 Arm extension: max. 55 mm
 Retainer extension: max. 18 mm
 Thrust: max. 1 t

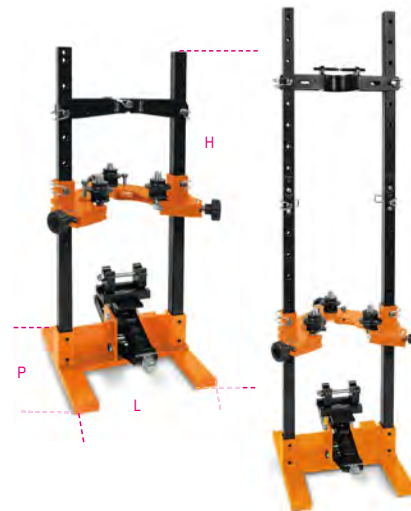

L	H	P	€	1	030720010	
mm	mm	mm				
3072N	390	785	390	1.049,00		

3073

universal fork oil seal driver fitting tool

for fork tube diameters 35 ÷ 48 mm



3073	€	1	030730001
	79,50		

3075A

hexagon socket for wheel hub nuts

12"



Ø	Ø	L	€	1	030750028
mm	mm	mm			
3075A	28	38	30	26,00	
3075A	30	40	30	28,00	

3075B

bi-hex socket for wheel hub nuts

12"



mm	Ø	L	€	1	030750155
mm	mm	mm			
3075B	55	70,7	25	66,50	

3075MV

bi-hex socket for MV AGUSTA wheel hub nuts

12"

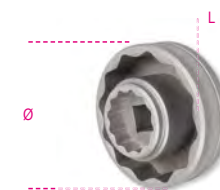

mm	Ø	L	€	1	030750156
mm	mm	mm			
3075MV	56	70,7	30	75,00	

3075/CM

multiple hexagon socket for wheel pins



3075/CM	€	1	030750212
12-14-17-19-22-24 mm	37,00		

3075/K10

set with a universal wrench with interchangeable head and 10 bits, for tightening wheel spokes

Sizes: 5.2 - 5.4 - 5.6 - 5.8 - 6.0 - 6.2 - 6.4 - 6.6 - 6.8 - 7.0



3075/K10	€	1	030750410
	50,00		

3079/21

cable oiler

Allows proper lubrication of clutch cables and gas control, for increased sheath smoothness and cable duration.



3079/21	€	1	030790021
	7,60		

3080/C15

chain opening and riveting kit



ø 3-4-5 mm and Regina kit



3080/C15	€ 330,00	1	030800015
420x185x60 mm			

3080R/CS3

kit with 3 spare pin punches for chain tool 3080/C15



ø 3-4-5 mm



3080R/CS3	€ 51,50	1	030800503
-----------	---------	---	-----------

3081

portable chain tool



Sturdy and foldable, easily fitting into enduro tool bags. Suitable for chain sizes 415, 420, 428, 520, 525, 530, 532



3081	€ 41,50	1	030810010
------	---------	---	-----------

3085

tool for retracting brake pistons



Suitable for motorcycle and scooter brake callipers



3085	€ 92,00	1	030850010
------	---------	---	-----------

3091

flywheel pullers with internal thread



	M	€	1	030910010
3091/10	24x1,5	19,30	1	030910010
3091/20	26x1,0	20,30	1	030910020
3091/30	28x1,0	20,50	1	030910030
3091/40	30x1,0	27,50	1	030910040
3091/45	30x1,5	27,50	1	030910045
3091/50	32x1,5	30,00	1	030910050
3091/60	33x1,5	31,50	1	030910060
3091/70	35x1,0	44,50	1	030910070
3091/75	35x1,5	44,50	1	030910075
3091/80	38x1,5	48,00	1	030910080

3092

flywheel pullers with external thread



	M	€	1	030920010
3092/10	18x1,5	10,30	1	030920010
3092/20	19x1,0	11,90	1	030920020
3092/30	27x1,25/20x1	12,50	1	030920030
3092/35	22-26x1,5	12,50	1	030920035
3092/40	25x1,5/22x1	12,50	1	030920040
3092/50	26-28x1,0	12,50	1	030920050
3092/60	28x1,5	12,30	1	030920060

3093/E

tool for locking flywheel, clutch bell and pulleys



3093/E	€ 34,00	1	030930100
--------	---------	---	-----------

3093/U

multiple flywheel puller



3093/U	€ 33,00	1	030930050
M10x1.25R			
M14x1.5R			
M16x1.5R			
M18x1.5R			
M24x1.0R			
M27x1.0L			

3094PA

OFFROAD motorcycle breakdown service panel



Metal frame; legs can be folded into frame; recommended for tool arrangement in racing fields available in 3 colours:

- 3094PA-O Orange
- 3094PA-G Grey
- 3094PA-R Red

Optional accessories:

- paper roll holder 3200 PR
- magnetic universal bottle holder 2499PF/M



	L mm	H mm	H1 mm	€	1	030940101
3094PA-O	750	1555	900	483,00	1	030940101
3094PA-G	750	1555	900	483,00	1	030940102
3094PA-R	750	1555	900	483,00	1	030940103

3099E

outdoor motorcycle cover, water and dust resistant



protects paint from scratches, dust and sunlight



Size "M" recommended for sports and naked motorcycles and mid-size scooters

Size "L" recommended for maxi enduro and crossover motorcycles

	€	1	030990102
3099E/M	77,00	1	030990102
3099E/L	95,00	1	030990103

3099T

indoor motorcycle cover, made from stretch fabric



protects paint from scratches, dust and sunlight



Size "M" recommended for sports and naked motorcycles and mid-size scooters

Size "L" recommended for maxi enduro and crossover motorcycles

Size "XL" recommended for super touring motorcycles

	€	1	030990202
3099T/M	67,00	1	030990202
3099T/L	82,00	1	030990203
3099T/XL	99,50	1	030990204

BICYCLE TOOLS



We partner UAE Team Emirates, which is led by the General Manager, Giuseppe Saronni, and competes at UCI World Tour level



Partnership 2021

3912TP



TOP workshop workbench for bicycle maintenance

- With support for central movement, with safety pin
- Tool drawer with ball bearing slides (490x365x90 mm)
- Built-in wheel truing stand
- Innovative thru-axle locking system



3912TP	€ 1.375,00	1	039120050
--------	------------	---	-----------

3912PP



PRO workshop workbench for bicycle maintenance

- With support for central movement, with safety pin
- Built-in wheel truing stand
- Innovative thru-axle locking system



3912PP	€ 750,00	1	039120150
--------	----------	---	-----------

3916TP/A



adapter socket for thru-axle forks

For workbenches 3912TP and 3912PP



L mm	Ø mm	Ø1 mm	€		
39	30	5	18,40	1	039120052

3912TP/C

universal adapter socket for thru-axle forks, hexagon socket tightening



For workbenches 3912TP and 3912PP



L mm	Ø mm	€		
29	30	18,40	1	039120054

3912TP/FOX

adapter sockets for FOX® forks



For workbenches 3912TP and 3912PP



L mm	€		
38	18,40	1	039120058

3912TP/QRE

adapter pin for forks without thru-axes



For workbenches 3912TP and 3912PP



L mm	€		
108	30,50	1	039120064

3912TP/ROAD

adapter socket for road forks



For workbenches 3912TP and 3912PP



L mm	Ø mm	€		
33	35	20,40	1	039120060

3912TP/RS

adapter socket for ROCKSHOX® thru-axle forks



For workbenches 3912TP and 3912PP



L mm	Ø mm	€		
35	30	18,40	1	039120056

3912TP/ST

adapter socket for SUNTOUR forks



For workbenches 3912TP and 3912PP



L mm	Ø mm	Ø1 mm	€		
31	30	18	20,40	1	039120062

3916MMP

workshop single-sided clamp for bicycle maintenance



- Clamp can be rotated 360°, with floating jaws and micrometric adjustment
- Carrying capacity: 25 kg
- Plastic tool tray



3916MMP	€		
	713,00	1	039160150

3921

derailleur hanger alignment gauge

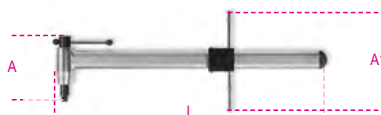

L mm	A mm	A1 mm	€		
440	115	165	96,00	1	039210010

3923

blade guide tool for cutting airfoil shaped seatposts up to 80 mm and tubes 1" ÷ 1.1/2"

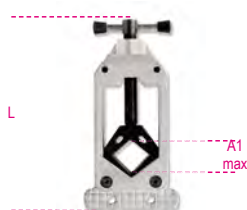

L mm	A1 max mm	Ø max mm	€		
160	80	45	45,50	1	039230010

3927

handlebar clamp



3927	L mm	€		
	365	27,50	1	039270010

3932U

professional chain tool compatible with chains from 5 to 11 speeds



L mm	L1 mm	€		
164	115	50,50	1	039320011

3935

chain wear indicator



L mm	€		
120	8,55	1	039350010

3937

missing link pliers



L mm	€		
170	22,20	1	039370010

3948

crank extractor



Ø mm	L mm	Ø mm	• mm	€		
14	79	20	15	17,10	1	039480015



3952

simple cone wrench



mm	L mm	€	1	039520013
13	205	22,20	2	039520013
14	205	22,20	2	039520014
15	205	22,20	2	039520015
16	205	22,20	2	039520016
17	205	22,20	2	039520017
18	205	22,20	2	039520018
19	205	22,20	2	039520019
20	205	22,70	1	039520020
21	205	22,70	1	039520021
22	205	22,70	1	039520022
24	205	23,30	1	039520024



€	1	039520207
155,50	1	039520207
247,00	1	039520211

3953

pedal wrench



mm	L mm	€	1	039530015
15	401	34,50	1	039530015

3955

open end wrenches for universal headsets



mm	L mm	€	1	039550108
30x32	292	32,00	1	039550108
32x36	319	35,50	1	039550114

39613.2

spoke wrench, black, 3.2 mm



mm	€	1	039610032
3,2	12,50	1	039610032

39613.3

spoke wrench, green, 3.3 mm



mm	€	1	039610033
3,3	12,50	1	039610033

39613.5

spoke wrench, red, 3.5 mm



mm	€	1	039610035
3,5	12,50	1	039610035

3961U

professional spoke wrench, 3.2 - 4.0 mm



mm	€	1	039610100
3,2 - 4,0	20,50	1	039610100

3962SH

double spoke wrench for Shimano



L mm	A1 mm	A2 mm	€	1	039620010
132	4,3	4,4	15,80	1	039620010

3962MV

double spoke wrench for Mavic



L mm	A1 mm	A2 mm	€	1	039620020
135	4,3	8,4	16,50	1	039620020

3963P

special wrench for flat spokes



L mm	€	1	039630010
129	7,50	1	039630010

3964

special nipple driver



L mm	L1 mm	€	1	039640010
170	89	18,60	1	039640010

3965

wheel alignment gauge, ø 20" ÷ 29"



L mm	€	1	039650010
680	91,00	1	039650010

3965C

professional wheel truing stand



- For ø 20" ÷ 29"
- Through axle hub adapter, 10 ÷ 20mm

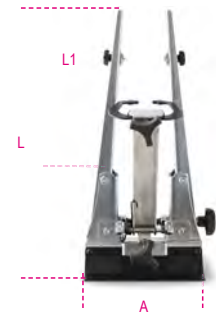

L mm	L1 mm	A mm	€	1	039650110
500	380	285	367,00	1	039650110

3967

sprocket removal wrench with chain whip



- Caters for up to 11 speed cassettes
- 2PVC handle
- Also suitable for fixed wheels



L mm	€	1	039670010
289	50,00	1	039670010

3969

tyre lever



L mm	A mm	€	1	039690010
200	15,6	9,10	1	039690010

3969K3

kit with 3 tyre levers, made of plastic



L mm	€	1	039690130
113	5,05	1	039690130

3971

wrench for Shimano plastic bolts



- Suitable for Shimano Hollowtech II cranksets



N°	mm	€	1	039710010
8	8	11,10		

3972

bottom bracket removal wrench



- Suitable for Shimano® Hollowtech II, Campagnolo® Ultra-torque, FSA®, SRAM®



L	€	1	039720010
mm 252	21,50		

3973PF

Press-Fit bearing removal tool



- Suitable for inside Ø 24 mm and 30 mm



L	€	1	039730001
mm 240	28,50		

3973/1

16-notch bottom bracket removal socket



- Suitable for Shimano® XTR BB93, Dura-Ace® BB900

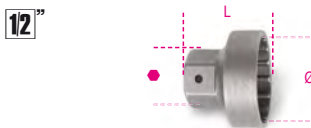

Ø	mm	mm	L	mm	€	1	039730010
39	24	34		18,50			

3973/2

16-notch bottom bracket removal socket



- Suitable for Shimano® BBR60 (Ultegra® 11 speeds)

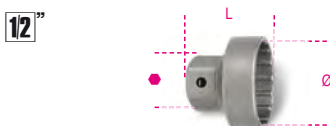

Ø	mm	mm	L	mm	€	1	039730020
41	24	35		18,50			

3973/3

16-notch bottom bracket removal socket



- Suitable for Shimano® Hollowtech II, Campagnolo® Ultra-torque, FSA®, SRAM®

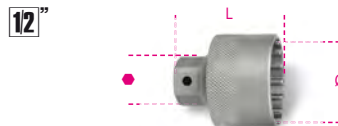

Ø int.	mm	mm	L	mm	€	1	039730030
46	24	53,5		18,50			

3973/4

20-notch bottom bracket removal socket with central pin, nickel-plated



- Suitable for Shimano and ISIS



Ø	mm	L	mm	mm	€	1	039730040
31,5	55	24		11,60			

3975

bearing cup press



- For headset cup assembly, compatible with headset cups 1", 1.1/8", 1.1/4", 1.1/2" and 2"



L	mm	Ø	mm	€	1	039750010
360	16x1		244,00			

3984/1

BMX freewheel removal wrench, 2 grafts

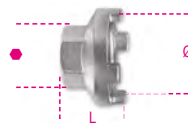

Ø	mm	L	mm	mm	€	1	039840010
35	25,5	24		13,60			

3984/2

Shimano freewheel removal wrench



Ø	mm	L	mm	mm	€	1	039840020
22,8	26	24		8,55			

3984/3

Shimano freewheel removal wrench, cassette with guide pin

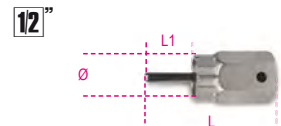

Ø	mm	L	mm	L1	mm	€	1	039840030
23,5	65	25		14,80				

3984/4

Campagnolo freewheel removal wrench, with guide pin



Ø	mm	L	mm	L1	mm	mm	€	1	039840040
23	51	13	24	19,30					

3984/5

freewheel removal wrench, 2 grafts



Ø	mm	L	mm	mm	€	1	039840050
18,5	38	21		13,60			

3984/6

freewheel removal wrench, 4 grafts

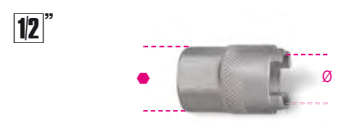

Ø	mm	L	mm	mm	€	1	039840060
19,5	36	21		13,60			

3991

lever for pushing back disc brake pads



L	mm	A	mm	α	°	€	1	039910010
222	36	7°		32,50				

3992

disc brake straightener



L	mm	A1	mm	€	1	039920010
234	4	55	2,2	24,40		

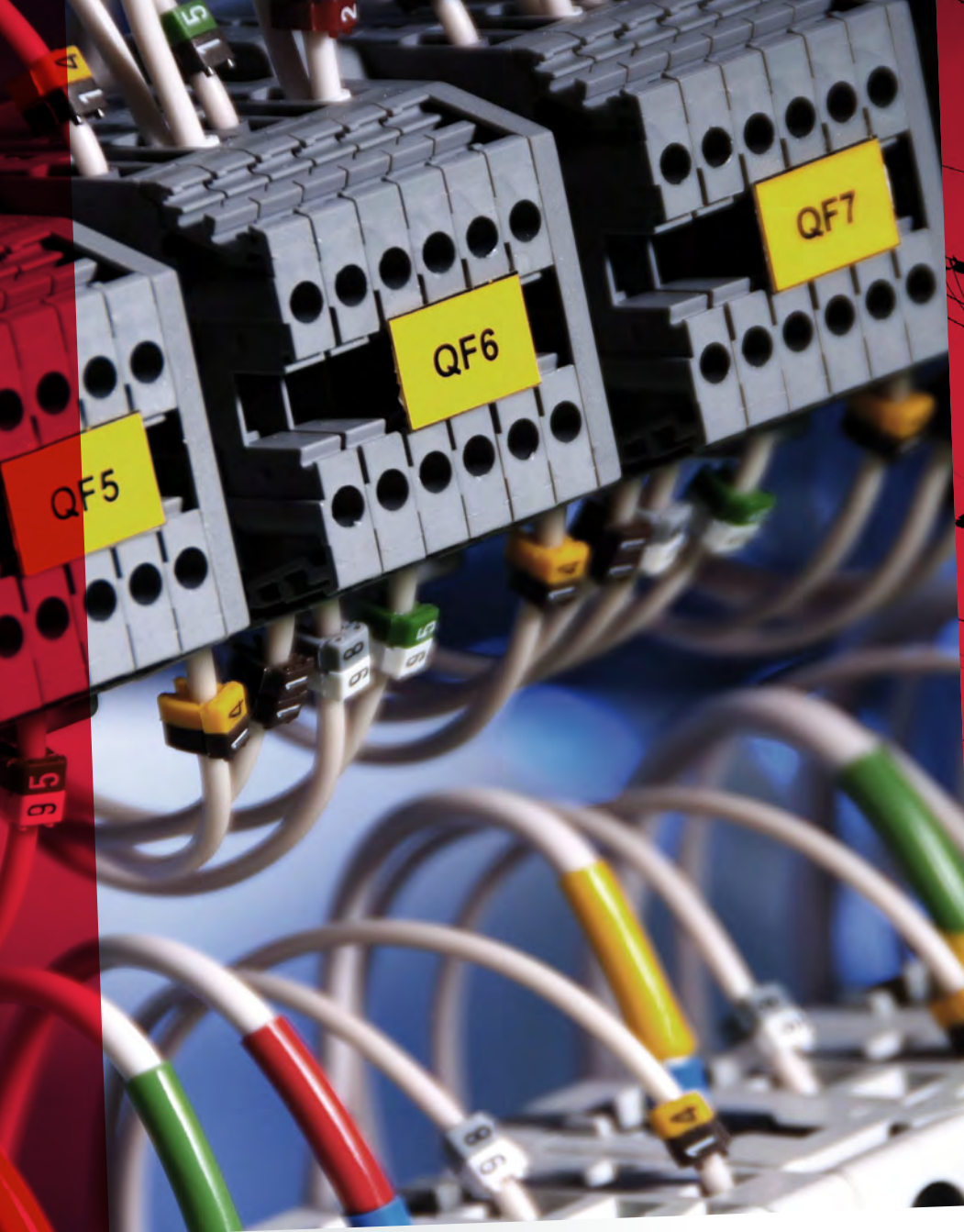

INSULATED TOOLS

Beta Utensili's insulated tools are meant to guarantee installation and electrical maintenance men's safety. All of the insulated tools make it possible to work on systems up to 1000V on alternating current and up to 1500V on direct current.

To provide the highest quality and performance standards and verify fitness and compliance with EN 60900, each tool is subjected to the following stringent tests: handle resistance to slipping and flame propagation, and high voltage test (10000V). For assortments and thermoformed trays, see relevant sections.

All of Beta's insulated tools are built in accordance with the specifications of EN60900 and are approved by the best European certification institutions



Istituto Italiano del Marchio di Qualità - I



Verband der Elektrotechnik
Elektronik Informationstechnik - D

1000 V

SAFETY TESTS: tested at 10,000 V to work on 1,000 V electrical installations.

Beta's high-insulation tools are tested piece by piece at 10 kV, with a view to providing unparalleled quality for working instruments which are required to ensure ultra-high safety standards: they make it possible to work at voltages up to 1,000 V a.c. (1,500 V d.c.).



SAFETY STANDARDS:

Although extremely stringent tests are performed during production, before using a tool, the operator must always check the insulating handle for tears, modifications or damage. Keeping the dielectric properties unchanged in time is closely connected with the mechanical, chemical or thermal stress the tool may be subjected to. In case the insulator should get damaged, the tool cannot be considered safe for use in live installations. Always wear protective goggles and insulated gloves.

TESTS PERFORMED DURING PRODUCTION



100% visual test:

All the surface finishes of the tools must be free from externally visible defects

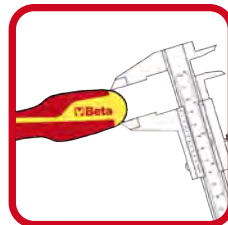

Dimensional test:

All the dimensions of the tools must comply with the design specifications.



Crash test:

After 2 hours at -25°C , the tool is hit three times (by such a specific weight as provided for by the standard); the insulating handle must not show any signs of damage.

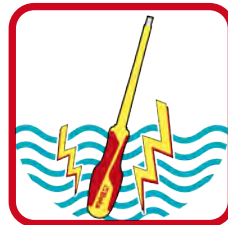

Electrical insulation test:

Following immersion in water for 24 hours, the tool is subjected to a voltage of 10 kV for 3 minutes. Current dissipation must not exceed such values as provided for by the standard.



Penetration test:

A weight of 2 kg is applied to the tool handle at $+70^{\circ}\text{C}$ for two hours. Later a voltage of 5 kV is applied to the area that is subjected to mechanical pressure for 3 minutes. No signs of current passing through must be shown.

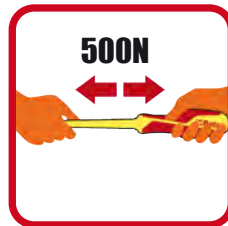

500N

Adhesion test:

after 168 hours at $+70^{\circ}\text{C}$, the tool is subjected to a load of 500 N to check that the handle does not slip off.

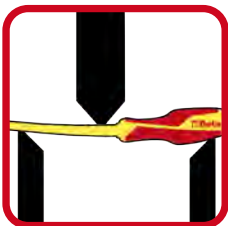

Mechanical test:

The tools must satisfy such mechanical performance requirements as provided for in the relevant ISO standards



Marking indelibility test:

Following the friction test with isopropyl alcohol, markings must remain legible.



Flame propagation test:

A flame is directed towards the tool for 10 seconds; during the next 20 seconds, the flame must not exceed a height of 120 mm.



52MQ

single open end wrenches



EN 60900
1000 V

EN 60900

mm	L mm	€	UN	ISO
6	90	30,00	1	000520106
7	96	30,00	1	000520107
8	100	30,00	1	000520108
9	108	30,00	1	000520109
10	110	30,00	1	000520110
11	120	30,00	1	000520111
12	132	32,00	1	000520112
13	140	34,00	1	000520113
14	146	35,00	1	000520114
15	166	36,00	1	000520115
16	156	39,00	1	000520116
17	168	39,00	1	000520117
18	170	40,50	1	000520118
19	176	40,50	1	000520119
21	190	44,50	1	000520121
22	200	44,50	1	000520122
24	225	47,50	1	000520124
27	210	62,50	1	000520127
30	240	65,50	1	000520130
32	240	66,50	1	000520132

89MQ

single ring wrenches



EN 60900
1000 V

EN 60900

mm	L mm	€	UN	ISO
6	150	38,50	1	000890106
7	155	38,50	1	000890107
8	155	38,50	1	000890108
9	160	38,50	1	000890109
10	170	38,50	1	000890110
11	180	38,50	1	000890111
12	190	42,50	1	000890112
13	195	45,00	1	000890113
14	200	47,50	1	000890114
15	210	48,50	1	000890115
16	216	52,00	1	000890116
17	218	52,00	1	000890117
18	236	55,50	1	000890118
19	240	55,50	1	000890119
21	250	63,50	1	000890121
22	255	63,50	1	000890122
24	280	71,50	1	000890124
27	300	76,00	1	000890127
30	320	89,50	1	000890130
32	340	91,00	1	000890132

110MQ

adjustable wrench with scale



EN 60900
1000 V

EN 60900

L mm	A max	€	UN	ISO
200	28	77,00	1	001100520
250	30	89,50	1	001100525
300	30	130,50	1	001100530

606MQ/50

click-type torque wrench with reversible ratchet



EN 60900
UNI EN 26789
ISO 6789

Nm	Kgfm	lbf.ft	A mm	L mm	g
5÷50	0,5÷5	4÷40	90	375	1130

606MQ/50	749,00	1	006060705
----------	--------	---	-----------

850MQ

magnetic bit holder, insulated, with bimaterial handle



IMQ CSV
EN 60900

L mm	L1 mm	D mm	€	UN	ISO
233	125	12,5	22,70	1	008500910

910MQ/B

bi-hex sockets



EN 60900

mm	L mm	Ø1 mm	Ø mm	€	UN	ISO
6	45	14	24	28,00	1	009100616
7	45	15	24	28,00	1	009100617
8	45	16	24	28,00	1	009100618
9	45	17	24	28,00	1	009100619
10	45	19	24	28,00	1	009100620
11	45	20	24	28,00	1	009100621
12	45	24	24	28,00	1	009100622
13	45	24	24	28,00	1	009100623
14	45	25	24	28,00	1	009100624
15	45	27	24	29,50	1	009100625
16	45	27,5	24	29,50	1	009100626
17	45	30	24	30,00	1	009100627
18	45	31	24	30,00	1	009100628
19	45	32	24	30,00	1	009100629

910MQ/PE

socket drivers for hexagon screws



EN 60900

mm	Ø mm	L mm	€	UN	ISO
4	24	100	31,50	1	009100604
5	24,5	100	31,50	1	009100605
6	25,0	100	31,50	1	009100606
8	25,0	100	31,50	1	009100608
10	25,5	100	32,50	1	009100610

910MQ/TX

socket drivers for Torx(R) head screws



EN 60900

mm	Ø mm	L mm	L1 mm	€	UN	ISO
15	23	116	61	40,00	1	009100641
20	24,5	116	65	40,00	1	009100642
25	24,5	116	65	40,00	1	009100643
27	24,5	116	65	40,00	1	009100644
30	24,5	116	65	41,00	1	009100645
40	24,5	116	65	41,50	1	009100646

910MQ/XZN

socket drivers with XZN® profile



EN 60900

mm	Ø mm	L mm	L1 mm	€	UN	ISO
M8	24	106	57	37,00	1	009100658
M10	24	106	57	38,50	1	009100660

910MQ/PT

preset extensions with 3/8" female drive



EN 60900

Nm	L mm	L1 mm	€	UN	ISO
12	80	35,5	210,00	1	009100801

910MQ/21

3/8" drive extension



EN 60900

L mm	Ø mm	€	UN	ISO
140	13,4	51,00	1	009100804

910MQ/22

3/8" drive extension



EN 60900

L mm	Ø mm	€	UN	ISO
265	13,4	55,50	1	009100805

910MQ/T

3/8" drive, T-handle



EN 60900

L mm	L1 mm	€	Wrench	Accessories
200	165	60,50	1	009100807

910MQ/55

3/8" drive reversible ratchet



EN 60900

L mm	D mm	A mm	€	Wrench	Accessories
203	41	67	172,50	1	009100808

910MQ/C16

8 bi-hex sockets, 4 hexagon socket drivers and 4 accessories



EN 60900

910MQ/C16	€	Wrench	Accessories
	750,00	1	009100917

	910MQ/B	8 - 10 - 11 - 12 - 13 - 14 - 17 - 19 mm
	910MQ/PE	4 - 5 - 6 - 8 mm
	910MQ/21	125 mm
	910MQ/22	250 mm
	910MQ/T	
	910MQ/55	

914MQ/A

hexagon hand sockets, 3/8" female drive, made from special polyamide-based technopolymers
Specially designed for batteries of hybrid and electric cars

For use with torque wrench



EN 60900

Wrench	Ø mm	L mm	Ø1 mm	€	Wrench	Accessories
8	17,5	45	20	14,30	2	009140008
10	20,5	45	20	14,30	2	009140010
13	24	45	20	14,30	2	009140013
17	30	45	22	14,30	2	009140017



EN 60900

914MQ-A/S4	€	Wrench	Accessories
8-10-13-17 mm	57,00	1	009140054

920MQ/A

hexagon sockets



EN 60900

Wrench	Ø mm	L mm	Ø1 mm	€	Wrench	Accessories
8	21,5	57	27,5	28,00	1	009200238
9	21,5	57	27,5	28,00	1	009200239
10	21,5	57	27,5	28,00	1	009200240
11	21,5	57	27,5	28,00	1	009200241
12	23,0	57	27,5	28,00	1	009200242
13	23,0	57	27,5	28,00	1	009200243
14	23,0	57	27,5	29,00	1	009200244
16	23,0	57	27,5	29,50	1	009200246
17	30,0	57	27,5	29,50	1	009200247
18	32,0	57	27,5	30,00	1	009200248
19	32,2	57	27,5	30,00	1	009200249
20	32,0	57	27,5	34,00	1	009200250
21	34,0	57	27,5	34,00	1	009200251
22	36,0	57	27,5	34,00	1	009200252
24	39,0	57	27,5	35,00	1	009200254
27	42,0	57	27,5	35,50	1	009200257
30	44,0	57	27,5	36,50	1	009200260
32	48,0	57	27,5	37,50	1	009200262

920MQ/PE

socket drivers for hexagon screws



EN 60900

Wrench	Ø mm	L mm	L1 mm	€	Wrench	Accessories
*4	28,5	94,50	10,5	47,00	1	009200264
*5	28,5	94,5	10,5	47,00	1	009200265
*6	28,5	94,5	10,5	47,00	1	009200266
*8	28,5	94,5	10,5	47,00	1	009200268
10	28,5	94,5	10,5	49,00	1	009200267
12	28,5	94,5	10,5	49,00	1	009200269

920MQ/21

1/2" square drive extension bar



EN 60900

L mm	Ø mm	€	Wrench	Accessories
135	28	54,00	1	009200804

920MQ/22

1/2" square drive extension bar



EN 60900

L mm	Ø mm	€	Wrench	Accessories
264	30	61,50	1	009200805

920MQ/T

1/2" square drive, T-handle



EN 60900

L mm	L1 mm	€	Wrench	Accessories
200	163	65,00	1	009200807

920MQ/55A

1/2" square drive reversible ratchet with socket locking system

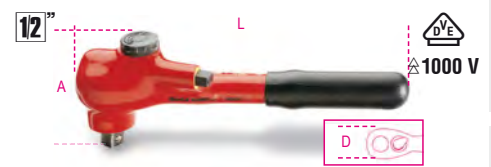

EN 60900

L mm	D mm	A mm	€	Wrench	Accessories
240	50	89	230,00	1	009200809

920MQ/C16

9 hexagon sockets,
3 socket drivers for hexagon screws
and 4 accessories

12"



1000 V

EN 60900

920MQ/C16 € 878,00 1 009200917

- 920MQ/A 8 - 10 - 12 - 13 - 14 - 17 - 19 - 22 - 24 mm
- 920MQ/PE 5 - 6 - 8 mm
- 920MQ/21 135 mm
- 920MQ/22 264 mm
- 920MQ/55A
- 920MQ/T

420x280x60 mm - 5,2 kg

943MQ

hexagon nut spinners with handles



1000 V

EN 60900

mm	L mm	L1 mm	D mm	€		
5,5	233	125	12,2	18,00	1	009430235
6	233	125	12,5	18,00	1	009430236
7	240	125	14,3	19,00	1	009430237
8	240	125	15,3	19,60	1	009430238
10	252	125	17,3	20,30	1	009430240
13	252	125	21,3	22,20	1	009430243

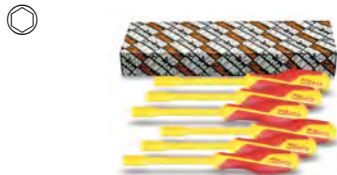

943MQ/S6 € 117,00 1 009430250
5,5-6-7-8-10-13 mm

951MQ

T-handle wrenches with hexagon
male ends

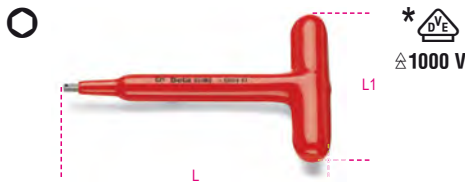

1000 V

EN 60900

mm	L mm	L1 mm	€		
3	120	105	45,00	1	009510703
* 4	165	105	46,00	1	009510704
* 5	170	105	46,00	1	009510705
* 6	168	105	46,00	1	009510706
* 8	165	105	47,00	1	009510708
10	200	105	49,00	1	009510710

993MQ

bent knurled point spring tweezers



1000 V

EN 60900

L mm 147 € 37,50 1 009930040

994MQ

straight knurled point spring tweezers



1000 V

EN 60900

L mm 145 € 36,50 1 009940040

1010MQ

long round nose pliers



1000 V

EN 60900

L mm 160 L1 mm 51,5 € 45,50 1 010100096

1048MQ

slip joint pliers, boxed joint

• Chrome-plated finish



1000 V

EN60900

L mm 250 A max mm 48 L1 mm 39 € 67,00 1 010480315

1082MQ

diagonal cutting nippers



1000 V

EN 60900

L mm 140 L1 mm 20 1,6 € 45,00 1 010820094
L mm 160 L1 mm 22 1,6 € 47,00 1 010820096

1084MQ

heavy duty diagonal cutting nippers



1000 V

EN 60900

L mm 200 L1 mm 26 2,0 € 59,50 1 010840100

1088MQ

end cutting nippers



1000 V

EN 60900

L mm 160 L1 mm 7 1,6 € 56,00 1 010880096

2115P L-MQ32

long round nose pliers



2115PL-MQ32 € 339

1128MQ

electrician's scissors,
stainless steel blades,
with microteeth



1000 V

IEC60900

L mm 145 L1 mm 45 € 46,50 1 011280101

1132MQ

cable cutter with insulated handles
for copper and aluminium cables



1000 V

EN 60900

L mm 230 18 € 86,00 1 011320193

1142MQ

wire stripping pliers



EN 60900

L mm	mm ²	€	🛒	📄
160	0,5÷6	50,00	1	011420096

1150MQ

combination pliers, bright chrome-plated



EN 60900

L mm	L1 mm	mm	€	🛒	📄
160	37	1,6	43,00	1	011500096
180	39	1,8	46,50	1	011500098
200	43	2,0	49,00	1	011500100
220	46	2,0	53,50	1	011500102

1162MQ

extra long flat nose pliers



EN 60900

L mm	L1 mm	mm	€	🛒	📄
160	56	1,6	46,00	1	011620096
200	76	1,6	49,00	1	011620100

1164MQ

extra-long bent flat nose pliers



L mm	L1 mm	mm	€	🛒	📄
160	54	1,6	48,00	1	011640096
200	76	1,6	51,00	1	011640100

1166MQ

extra long needle nose pliers



EN 60900

L mm	L1 mm	mm	€	🛒	📄
160	56	1,6	46,00	1	011660096
200	76	1,6	49,00	1	011660100

1168MQ

extra long bent needle nose pliers



EN 60900

L mm	L1 mm	mm	€	🛒	📄
160	50	1,6	48,00	1	011680096
200	70	1,6	51,00	1	011680100

1272MQF

screwdrivers for cross head Phillips® screws

Slim

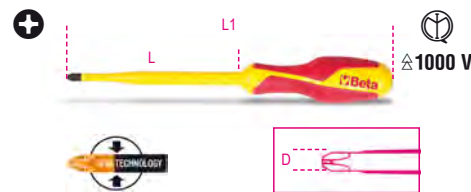

EN60900

PHxDxL mm	L1 mm	€	🛒	📄
1x4,5x80	187	13,50	3	012720609
2x6x100	218	15,30	3	012720618

1272MQ

screwdrivers for cross head Phillips® screws



EN 60900

PHxDxL mm	L1 mm	€	🛒	📄
0x3x60	160	9,10	3	012720703
1x4,5x80	187	11,10	3	012720709
2x6x100	218	12,80	3	012720718
3x8x150	276	16,50	2	012720724
4x10x200	326	19,60	2	012720727



1272MQ/S5	€	🛒	📄
PH0x3x60-PH1x4,5x80 PH2x6x100-PH3x8x150 PH4x10x200 mm	69,00	1	012720751



1273MQF/D...

set of 6 slim screwdrivers



1273MQF/D4	€	🛒	📄
1272MQF 1x4,5x80-2x6x100 mm 1274MQF 0,6x3,5x100-1x5,5x125 mm	54,00	1	012730604

1273MQF/D6	€	🛒	📄
1272MQF 1x4,5x80-2x6x100 mm 1274MQF 0,6x3,5x100-1x4,5x100-1x5,5x125-1,2x6,5x150 mm	83,00	1	012730606

1273MQ/D6

set of 6 screwdrivers



1273MQ/D6	€	🛒	📄
1274MQ 0,5x3x100-0,8x4x100 1,0x5,5x125 mm 1272MQ PH0x3x60-PH1x4,5x80 PH2x6x100 mm	65,00	1	012730851

1274MQF

screwdrivers for headless slotted screws

Slim

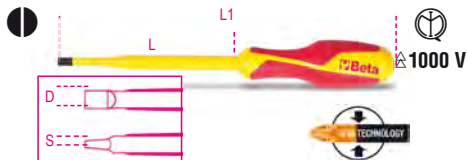

EN60900

SxDxL mm	L1 mm	€	🛒	📄
0.6x3.5x100	200	11,60	3	012740603
1x4.5x100	205	12,90	3	012740606
1x5.5x125	232	13,60	3	012740609
1.2x6.5x150	268	16,30	3	012740612

1274MQ

screwdrivers for headless slotted screws

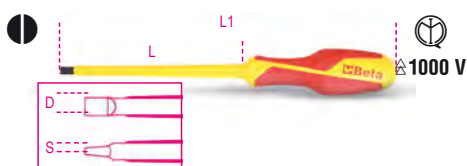

EN 60900

SxDxL mm	L1 mm	€	🛒	📄
0,4x2,5x75	175	8,85	3	012740700
0,5x3x100	200	9,30	3	012740703
0,8x4x100	207	10,90	3	012740706
1x5,5x125	232	11,70	3	012740709
1,2x6,5x150	268	14,10	3	012740712
1,2x8x175	301	16,50	2	012740715
1,6x10x200	326	19,50	2	012740718



1274MQ/S6 € 82,00 1 012740751
 0,5x3x100-0,8x4x100
 1x5,5x125-1,2x6,5x150
 1,2x8x175-1,6x10x200 mm

1275MQ/C

screwdrivers for combined cross head PH + slotted head screws

slim



EN60900

PH1+LPP € 12,50 2 012750409
 PH2+LPP € 14,10 2 012750418

1276MQ/C

screwdrivers for combined cross head PZ + slotted head screws

slim



EN 60900

PZ1+LPP € 12,50 2 012760409
 PZ2+LPP € 14,10 2 012760418

1279MQ/F

screwdrivers for cross head Pozidriv®-Supadriv® screws

slim



EN60900

pz	L mm	L1 mm	€	QTY	Code
1	80	187	12,50	3	012790409
2	100	218	14,10	3	012790418

1279MQ

screwdrivers for cross head Pozidriv®-Supadriv® screws



EN 60900

PZ	L mm	L1 mm	€	QTY	Code
0	60	160	9,40	3	012790703
1	80	187	11,30	3	012790709
2	100	218	13,00	3	012790718
3	150	276	17,10	2	012790724



1279MQ/S4 € 51,00 1 012790751
 PZ 0-1-2-3

1725MQ

mini-hacksaw frame



EN 60900

1725MQ L mm 260 H mm 85 € 86,00 1 017250030

1777MQ/C

cable stripping knife, insulated

• for multicore cables



EN 60900

1777MQ/C L mm 190 € 35,00 1 017770026

1777MQ/U

cable stripping knife, insulated



EN 60900

1777MQ/U L mm 190 € 31,50 1 017770011

1777RL/U

4 spare blades for utility knife 1777MQ/U



1777RL/U € 25,00 1 017770021

1995MQ/T

insulating mat

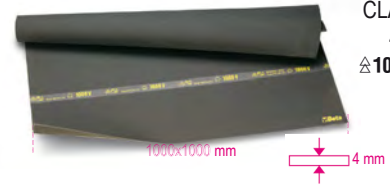

CLASS 4
 ⚡ 1000 V

VDE 0303
 EN 60243

LxSxH mm
1995MQ/T 1000x1000 € 289,00 1 019950030

1995MQ/G1 - G2

insulating gloves in latex



⚡ 1000 V

EN 60903

	Gr.	L mm	€	QTY	Code
1995MQ/G1	9	410	115,50	1	019950010
1995MQ/G2	10	410	115,50	1	019950013

1996MQ/T

insulating cloth

500x500mm

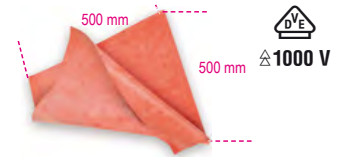

⚡ 1000 V

DIN EN 61112

S mm 0,5 € 87,50 1 019960005

1996MQ/GM

composite insulating gloves

EN60903
 EN388

⚡ 1000 V



EN 60903
 EN 61482

	Gr.	L mm	€	QTY	Code
1996MQ/GM 9	9	410	148,00	1	019960109
1996MQ/GM 10	10	410	148,00	1	019960110

1996SVG

pneumatic tester for insulated gloves

mandatory testing in accordance with EN90603



1996SVG € 338,00 1 019960133



TETHERED TOOLS

Beta H-SAFE

The H-SAFE tool range by Beta comprises over 200 coded items, for which a holding system has been individually designed to withstand extremely severe mechanical stress, as synonymous with unparalleled safety.

Operating comfort is also crucial: tools with a double active part, including combination wrench item 42, are tied with a cable which runs along the entire body of the tool; whereas twisting tools, including screwdrivers, are tied with freely rotating rings preventing the string from getting twisted.



The H-SAFE holding system has been designed, tested and manufactured in Beta's factories. With the H-SAFE system by Beta, tools are always within reach, comfortably and safely.

35HS

flat chisels, ribbed type

with H-SAFE tethered system



L mm	A mm	€	U	PC
200	23,0	36,50	1	000354004
250	28,5	46,00	1	000354005

42HS

combination wrenches, open and offset ring ends

with H-SAFE tethered system



DIN 3113 UNI-ISO 7738

mm	L mm	€	U	PC
6x6	95	18,90	1	000424506
7x7	105	19,20	1	000424507
8x8	116	19,40	1	000424508
9x9	127	20,00	1	000424509
10x10	137	20,20	1	000424510
11x11	148	20,70	1	000424511
12x12	158	20,90	1	000424512
13x13	169	21,20	1	000424513
14x14	180	22,10	1	000424514
15x15	190	22,50	1	000424515
16x16	201	23,00	1	000424516
17x17	212	24,20	1	000424517
18x18	222	24,80	1	000424518
19x19	233	25,50	1	000424519
20x20	243	26,00	1	000424520
21x21	254	27,50	1	000424521
22x22	264	28,00	1	000424522
23x23	275	29,50	1	000424523
24x24	285	31,00	1	000424524
25x25	296	31,00	1	000424525
26x26	307	32,00	1	000424526
27x27	317	34,50	1	000424527
28x28	328	35,00	1	000424528
29x29	338	38,00	1	000424529
30x30	349	39,50	1	000424530
32x32	370	44,00	1	000424532
34x34	391	71,50	1	000424534
36x36	412	78,50	1	000424536

42HS/AS

combination wrenches, open and offset ring ends

with H-SAFE tethered system



mm	L mm	€	U	PC
1/4x1/4	95	20,50	1	000424106
5/16x5/16	116	20,70	1	000424108
3/8x3/8	137	21,80	1	000424110
7/16x7/16	148	22,60	1	000424111
1/2x1/2	169	22,70	1	000424113
9/16x9/16	180	23,10	1	000424114
5/8x5/8	201	24,90	1	000424116
11/16x11/16	212	26,00	1	000424117
3/4x3/4	233	27,50	1	000424119
13/16x13/16	254	30,50	1	000424121
7/8x7/8	264	31,00	1	000424122

mm	L mm	€	U	PC
15/16x15/16	285	34,50	1	000424124
1x1	296	35,50	1	000424125
1.1/16x1.1/16	317	38,50	1	000424127
1.1/8x1.1/8	338	41,00	1	000424129
1.1/4x1.1/4	370	48,50	1	000424132
1.5/16x1.5/16	391	74,00	1	000424133

55HS

double open end wrenches

with H-SAFE tethered system



UNI-ISO 10102 DIN 3110

mm	L mm	€	U	PC
• 6x7	120	15,20	1	000554012
• 8x9	140	15,50	1	000554021
• 10x11	155	15,80	1	000554030
• 12x13	170	17,10	1	000554042
• 14x15	185	17,60	1	000554054
• 16x17	202	18,70	1	000554060
• 18x19	220	20,00	1	000554066
• 20x22	236	21,00	1	000554075
• 21x23	245	22,20	1	000554078
• 22x24	245	23,90	1	000554081
• 24x27	262	26,00	1	000554090
• 30x32	297	32,50	1	000554108
• 34x36	325	73,00	1	000554117

91HS-C

heavy duty offset ring wrenches

with H-SAFE tethered system



mm	Ø mm	€	U	PC
36	54	89,00	1	000914036
41	62	104,00	1	000914041
46	69	120,50	1	000914046

91HS

heavy duty offset ring wrenches with H-SAFE tethered system



mm	Ø mm	€	U	PC
36	54	177,50	1	000914236
41	62	192,50	1	000914241
46	69	227,00	1	000914246

92HS

tubes for item 91 with H-SAFE tethered system



L mm	91 mm	Ø mm	€	U	PC
610	32÷41	22	88,50	1	000924020
760	46÷55	25	106,50	1	000924030

93HS

double-ended offset ring wrench for scaffolding bolts with H-SAFE tethered system



mm	L mm	€	U	PC
21x22	310	51,50	1	000934021

96THS

offset hexagon key wrenches, with high torque handles

with H-SAFE tethered system



mm	L mm	L1 mm	€	U	PC
2,5	153	55	23,30	1	000964935
3	153	55	23,90	1	000964936
4	179	70	24,40	1	000964938
5	200	84	24,90	1	000964940
6	221	103	26,50	1	000964941
8	255	117	31,00	1	000964943
10	285	132	34,00	1	000964945

96THS-AS

offset hexagon key wrenches, with high torque handles with H-SAFE tethered system

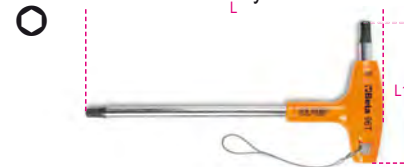

mm	L mm	L1 mm	Ø mm	€	U	PC
5/32	200	84	6	26,50	1	000964673
3/16	200	84	6	26,50	1	000964674
7/32	221	103	7	29,00	1	000964675
1/4	236	106	8	30,00	1	000964676
5/16	255	117	10	32,50	1	000964678
3/8	285	132	12	36,00	1	000964680

97TTXHS

offset key wrenches with handles for Torx® head screws with H-SAFE tethered system

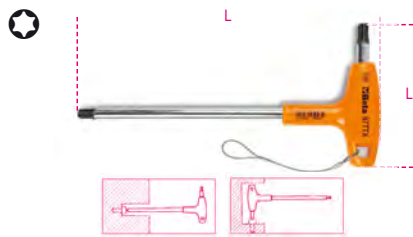

Ø	L	L1	€	🔧	📄
mm	mm	mm			
T10	179	70	23,90	1	000974710
T15	179	70	24,40	1	000974715
T20	179	70	24,90	1	000974720
T25	179	70	25,50	1	000974725
T30	200	84	28,50	1	000974730
T40	221	103	30,50	1	000974740
T45	236	106	33,00	1	000974745
T50	255	117	40,50	1	000974750

111HS

adjustable wrenches with scales, chrome-plated with H-SAFE tethered system

- Right-hand rotation of pin
- With mm and inch scale



DIN 3117 ISO 6787

L	L	A max	A1	€	🔧	📄
mm	mm	mm	mm			
200	8	28	62,0	45,00	1	001114020
250	10	34	70,0	51,00	1	001114025
300	12	35	84,0	63,00	1	001114030
380	15	45	97,0	107,50	1	001114038
450	18	54	115,0	170,00	1	001114045

142HS

reversible ratcheting combination wrenches with H-SAFE tethered system



Ø	L	€	🔧	📄
mm	mm			
8x8	136	29,50	1	001424008
9x9	143	30,50	1	001424009
10x10	159	31,00	1	001424010
11x11	168	31,50	1	001424011
12x12	174	32,00	1	001424012
13x13	180	33,00	1	001424013
14x14	190	34,00	1	001424014
15x15	200	35,50	1	001424015
16x16	216	37,50	1	001424016
17x17	233	38,50	1	001424017
18x18	239	41,00	1	001424018
19x19	248	41,50	1	001424019
21x21	285	49,50	1	001424021
22x22	285	50,50	1	001424022
24x24	325	58,50	1	001424024
27x27	355	77,50	1	001424027
30x30	420	89,50	1	001424030
* 32x32	420	93,00	1	001424032

* Straight model without inverter

360HS

pipe wrenches, Stillson pattern with H-SAFE tethered system



L	Ø	€	🔧	📄
mm	max*			
250	1" gas	48,00	1	003604025
350	1 1/2" gas	60,00	1	003604035
450	2" gas	77,00	1	003604045
600	2 1/2" gas	110,00	1	003604060



LC system, two-ball retaining system. Socket is only released through button

666HS

Click-type torque wrenches with reversible ratchets for right-hand tightening torque accuracy: ±3%

with H-SAFE tethered system



ISO 6789

Nm	Kgfm	lbf.ft	□	D	A	L	🔧
10÷50	1÷5	7÷37	3/8	mm	mm	mm	g
				30	33	312	660

666HS/5 252,00 1 006664005

Nm	Kgfm	lbf.ft	□	D	A	L	🔧
20÷100	2÷10	15÷75	3/8	mm	mm	mm	g
				30	33	381	730

666HS/10 256,00 1 006664010

Nm	Kgfm	lbf.ft	□	D	A	L	LC	🔧
40÷200	4÷20	30÷150	1/2	mm	mm	mm	system*	g
				40	43	470	*	1010

666HS/20LC 289,00 1 006664021

Nm	Kgfm	lbf.ft	□	D	A	L	LC	🔧
60÷300	6÷30	50÷220	1/2	mm	mm	mm	system*	g
				40	43	598	*	1380

666HS/30LC 324,00 1 006664031

900E-HS/55

reversible ratchets with H-SAFE tethered system



DIN 3122 - UNI-ISO 3315

L	Ø	A	€	🔧	📄
mm	mm	mm			
125	25	18	46,00	1	009004880

910E-HS/55

reversible ratchets with H-SAFE tethered system

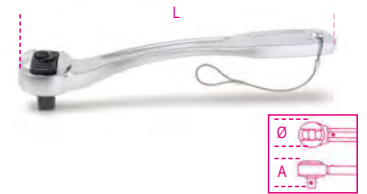

DIN 3122 - UNI-ISO 3315

L	Ø	A	€	🔧	📄
mm	mm	mm			
200	30	33	51,50	1	009104880

920E-HS/55LC

reversible ratchets "Locking System" with H-SAFE tethered system

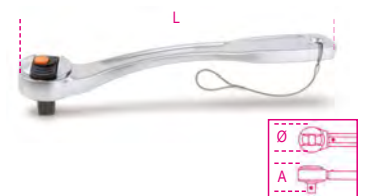

DIN 3122 - UNI-ISO 3315

L	Ø	A	€	🔧	📄
mm	mm	mm			
275	40	43	76,00	1	009204860

932HS

double ended hexagon / bi-hex offset socket wrenches, bright chrome-plated with H-SAFE tethered system

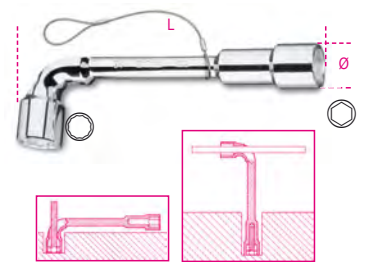

NF E 74.303

Ø	mm	L	mm	€	🔧	📄
6x6	11,5	110	25,50	1	009324006	
7x7	12,5	116	26,00	1	009324007	
8x8	13,0	120	27,50	1	009324008	
9x9	14,0	125	28,00	1	009324009	
10x10	16,5	133	28,50	1	009324010	
11x11	17,5	143	30,00	1	009324011	
12x12	19,0	148	31,00	1	009324012	
13x13	19,5	154	31,50	1	009324013	
14x14	21,5	167	34,00	1	009324014	
15x15	22,5	182	34,50	1	009324015	
16x16	24,5	193	35,50	1	009324016	
17x17	26,0	198	36,00	1	009324017	
18x18	26,5	215	38,50	1	009324018	
19x19	29,0	220	41,00	1	009324019	

1032HS

internal circlip pliers, straight pattern PVC-coated handles with H-SAFE tethered system



UNI 7914 DIN 5256

L mm	∅ mm	∅1 mm	A mm	€	🔌	📄
140x1,3	12÷25	1,3	20	35,00	1	010324014
180	19÷60	1,9	21	36,50	1	010324017

1034HS

internal circlip pliers, bent pattern, 90° PVC-coated handles with H-SAFE tethered system



UNI 7914 DIN 5256

L mm	∅ mm	∅1 mm	A mm	€	🔌	📄
170	19÷60	1,9	21	39,00	1	010344017

1036HS

external circlip pliers, straight pattern PVC-coated handles with H-SAFE tethered system



UNI 7915 DIN 5254

L mm	∅ mm	∅1 mm	A mm	€	🔌	📄
140x1,3	10÷25	1,3	20	36,50	1	010364014
175	19÷60	1,9	21	37,50	1	010364017

1038HS

external circlip pliers, bent pattern, 90° PVC-coated handles with H-SAFE tethered system



UNI 7915 DIN 5254

L mm	∅ mm	∅1 mm	A mm	€	🔌	📄
175	19÷60	-	21	40,50	1	010384017

1048BM-HS

slip joint pliers, boxed joint, bimaterial handles with H-SAFE tethered system

• new 9-position model



ISO 8976

L mm	A max mm	L1 mm	🔌 g	€	🔌	📄
250	48	39	460	58,00	1	010484215

1052HS

adjustable self-locking pliers, concave jaws with H-SAFE tethered system



L mm	A mm	A1 max mm	S mm	€	🔌	📄
240	72	42	10,0	47,50	1	010524024

1082BM-HS

diagonal cutting nippers, bi-material handles with H-SAFE tethered system



UNI/ISO 5749

L mm	L1 mm	🔌 mm	A mm	€	🔌	📄
160	22	1,6	28,0	46,50	1	010824036

1088BM-HS

heavy duty end cutting nippers, bi-material handles with H-SAFE tethered system

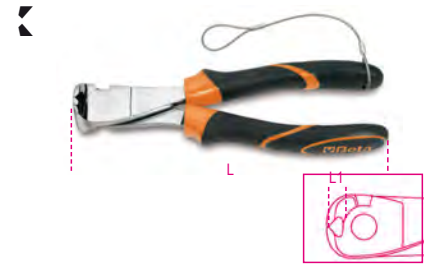

UNI/ISO 5748

L mm	L1 mm	🔌 mm	A mm	€	🔌	📄
160	9	1,6	28,0	54,00	1	010884036
200	11	2,0	36,0	67,50	1	010884040

1128BAX-HS

Double-acting electricians' scissors, with milling profiles in DLC-coated stainless steel with H-SAFE tethered system

Double-acting cutting: a special cam on the fulcrum allows the blades to run lengthwise, which results in increased cutting power while closing the blades.

Profile and mill: designed to enlarge holes on plastic, from 13 mm to 25 mm.

DLC coating: DLC (diamond-like carbon) is an innovative carbon-based coating: the high hardness and low coefficient of friction arise from the simultaneous presence of carbon on the surface in the form of graphite, and diamond.

- High blade surface hardness (resistance to abrasion and wear)
- Low coefficient of friction (smoothness and anti-adherence)
- Anti-loose eccentric pin
- Large handles with pipe throttling grooves
- With articulated plastic case



L mm	L1 mm	🔌 mm²	€	🔌	📄
150	50	50	45,00	1	011284088

1132BM-HS

cable cutters for insulated copper and aluminium cables, bi-material handles with H-SAFE tethered system



UNI 8791

L mm	🔌 mm	A mm	B mm	€	🔌	📄
230	18	37	12,5	82,00	1	011324143

1150BM-HS

combination pliers bright chrome-plated, bi-material handles with H-SAFE tethered system



ISO 5746

L	L1	mm	A	€		
mm	mm	mm	mm			
160	42	1,6	22,0	41,00	1	011504146
180	46	1,8	25,0	43,00	1	011504148
200	50	2,0	27,0	46,50	1	011504150

1166BM-HS

extra long needle knurled nose pliers, bi-material handles with H-SAFE tethered system



ISO 5745

L	L1	mm	A	€		
mm	mm	mm	mm			
200	76	1,6	22,0	48,00	1	011664040

1168BM-HS

extra long bent needle knurled nose pliers, bi-material handles



ISO 5745

L	L1	mm	A	€		
mm	mm	mm	mm			
200	70	1,6	22,0	51,00	1	011684040



1290HS

screwdrivers for slotted head screws H-SAFE



ISO 2380

SxAxL	L1	Ø	€		
mm	mm	mm			
0,4x2,5x75	171	2,5	16,80	1	012904006
0,5x3x100	196	3,0	17,30	1	012904012
0,6x3,5x100	196	3,5	18,50	1	012904021
0,8x4x100	196	4,0	18,10	1	012904030
0,8x4x150	246	4,0	19,30	1	012904036
1x5,5x150	259	5,0	21,50	1	012904042
1,2x6,5x150	270	6,0	22,90	1	012904051
1,2x8x150	282	7,0	25,50	1	012904057
1,6x10x200	332	8,0	29,50	1	012904066

1292HS

screwdrivers for cross head Phillips® screws with H-SAFE tethered system



UNI/ISO 8764

PHxDxL	L1	€		
mm	mm			
0x3x100	196	17,50	1	012924006
1x4,5x120	229	19,40	1	012924012
2x6x150	270	23,50	1	012924021
3x8x150	282	27,00	1	012924024

1294HS

screwdrivers for headless slotted screws with H-SAFE tethered system



SxDxL	L1	€		
mm	mm			
0,5x2,5x60	156	16,30	1	012944003
0,6x3x75	171	16,50	1	012944006
0,8x4x100	196	18,20	1	012944012
1x5x125	234	21,10	1	012944018

1299HS

screwdrivers for cross head Pozidriv(R)-Supadriv(R) screws with H-SAFE tethered system



UNI/ISO 8764

PZ	L	L1	€		
	mm	mm			
0	60	156	18,40	1	012994000
1	80	189	20,50	1	012994003
2	100	220	25,50	1	012994006
3	150	282	31,50	1	012994009

1370T-HS

mechanic's hammers fibre shaft with H-SAFE tethered system



g	A	L	L1	€		
mm	mm	mm	mm			
300	23	300	105	35,00	1	013704630
500	27	320	118	37,00	1	013704650
1000	36	360	135	46,50	1	013704700

1370FT-HS

riveting hammers, fibre shafts with H-SAFE tethered system



A	L	L1	B	€		
mm	mm	mm	mm			
28	280	86	22	47,50	1	013704528
30	280	92	24	48,00	1	013704530
36	300	104	29	57,00	1	013704536

1390HS

soft face hammers, wooden shafts with H-SAFE tethered system



UNI 7784

D	L	L1	€		
mm	mm	mm			
35	310	95	44,50	1	013904035
45	320	107	62,50	1	013904045

1392HS

dead-blow hammers, with interchangeable plastic faces, steel shafts with H-SAFE tethered system

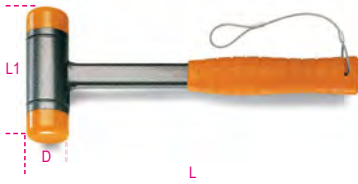

D	L	L1	€	Icon	Icon
mm	mm	mm			
35	305	115	63,50	1	013924035
40	310	125	71,00	1	013924040
50	325	135	83,00	1	013924050
60	385	155	120,50	1	013924060

1602A-HS

crimping pliers for insulated terminals, standard model with H-SAFE tethered system

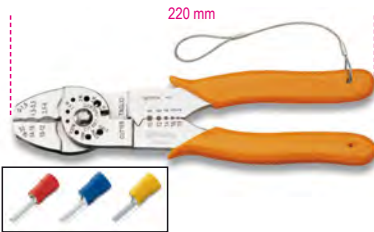

mm ²	L	A	B	€	Icon	Icon
0÷6	mm	mm	mm			
0÷6	220	42	4	67,50	1	016024005

1682HS

flexible graduated rules made from stainless steel with H-SAFE tethered system

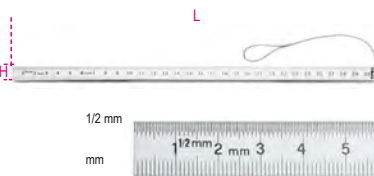

L	H	±	€	Icon	Icon
mm	mm	mm			
200	13	0,5	15,20	1	016824020
300	13	0,5	17,10	1	016824030

1692HS

measuring tapes, shock-resistant bi-material ABS casings, steel tapes, precision class II

with H-SAFE tethered system

CE



L	S	€	Icon	Icon
m	mm			
3	16	20,50	1	016924053
5	19	24,40	1	016924055

1708HS/20

metric feeler gauges with H-SAFE tethered system



S	S	L	€	Icon	Icon
mm	mm	mm			
0,05±1,0	0,002±0,040	105	22,70	1	017084020

1727HS

hacksaw frame, heavy series with H-SAFE tethered system



L	L1	€	Icon	Icon
mm	mm			
515	300	31,00	1	017274001

1743HS

fitting tool for nylon ties with H-SAFE tethered system

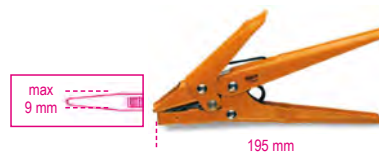

L	A	B	€	Icon	Icon
mm	mm	mm			
195	85	17	64,50	1	017434001

1750HS

lever operated grease guns with H-SAFE tethered system



1 g, 550 bar Max

cc	L	€	Icon	Icon
500	mm			
500	380	54,50	1	017504500

1760BHS

digital multimeter with H-SAFE tethered system

CE



SPECIFICATIONS

DC voltage: 200 mV-2/20/200/1000V
 AC voltage: 2-20/200/700V
 DC current: 2/20/200 mA-20 A
 AC current: 2/200 mA- 20 A
 Resistance: 200Ω - 2/20/200 kΩ - 2/20 MΩ
 Capacity: 2/20/200 nF - 2/200 μF
 Temperature: -20° + 1000°C/ -4 °F ~ +2000°F
 Frequency: 20kHz
 Power supply: 1 9V battery (included)

1760BHS	€	Icon	Icon
1760BHS	214,50	1	017604012

Beta

Beta

1772H-HS

safety utility knife with retractable blade, supplied with 2 blades with H-SAFE tethered system



L mm	A mm	€	1	017724029
170	18	28,00	1	017724029

1778SOS-HS

car service knife with window breaking hammer and seat belt cutter features in case with H-SAFE tethered system



L mm	A mm	L1 mm	€	1	017784080
205	25	85	45,00	1	017784080

8871

safety belt with metal double closure buckle. To connect H-SAFE tools



L cm	€	1	088710070
70-100	126,50	1	088710070
100-135	137,00	1	088710100

8872A

fixed loop

• For belt item 8871



L cm	€	1	088720050
20-140	22,20	1	088720050

8872AS

strap loop

• For belt item 8871



D mm	€	1	088720525
25	20,50	1	088720525

8873

tool bag with self-locking

• For belt item 8871



€	1	088730230
107,50	1	088730230

8877

cushioned hook-up lace

• MAX 2.7 kg



L cm min+max	DxL mm	€	1	088770080
70-110	40x80	27,50	1	088770080

8877M

cushioned hook-up lace

• With anti-winding joint
• MAX 2.7 kg



L cm min+max	DxL mm	€	1	088770510
20-140	30x60	49,00	1	088770510

8879

strap wristband

• MAX 2.7 kg



D mm	€	1	088790025
30	31,50	1	088790025

8880

hard hook-up lace

• With anti-winding joint



L cm	D mm	€	1	088800030
30	10	24,90	1	088800030

8883

tool bag

- Made of anti-abrasion nylon 840
- MAX 20 kg
- Snap link for stopping zip at top
- 6 tool retaining strings
- Interior pocket



DxH cm	€	1	088830030
30x40	260,00	1	088830030

Beta



STAINLESS STEEL TOOLS



Stainless steel is an alloy steel with a high chromium content.

Chromium forms a surface oxide film which protects metal and immediately reforms in case of chemical or mechanical damage.

We at **Beta Utensili** have relied on this unique characteristic to develop the **Beta Inox** tools, which are the name for high resistance to corrosion as well as remarkable **hygiene** and **low bacterial retentiveness**. Indeed, stainless steel tools **get less dirty and are cleaned better** than those made from other materials, and can be **autoclaved at 121 °C**.

The **Beta Inox** tools can be used in **critical environments** – that is, in areas where absolutely no contamination is permitted.

Fields of application:

- Nuclear applications
- Pharmaceutical production - class C
- Biotechnological and biomedical laboratories
- Food industry.

The **Beta Inox** tools avoid ferrous contamination, thus preventing improper **rust formation**. Whenever any tools made of ordinary carbon steel are used on stainless steel screws, nuts or surfaces, a few iron particles may come off the tools, which results in aesthetic problems (**iron moulds**). If neglected, these trigger localized corrosion. Using stainless steel tools will completely prevent polluting particles from spreading.



STAINLESS STEEL + NO STAINLESS STEEL = RUST



STAINLESS STEEL + STAINLESS STEEL = NO RUST

Fields of application:

- Shipyards
- Building
- Offshore applications
- Solar systems
- Car industry

Mechanical characteristics

Beta's tools are made of magnetic **steel AISI 420**. Its outstanding mechanical characteristics translate into tools whose performance far exceeds the standards and is comparable to that of Beta's other tools.

These tools share the same ergonomic properties and design as Beta's other tools, which have been known to, and appreciated by, professional users for over 80 years.

The containers are made of **steel AISI 304**, which can boast remarkable cold formability properties and even higher corrosion resistance.

Recyclability

Stainless steel is **100% recyclable**.

This is also a major plus.



Mark for stainless steel products
Released by Centro Inox – Italian Stainless Steel Development Association
– for products made of stainless steel.

34INOX

flat chisels,
made of stainless steel



L	A	Ø	€		
mm	mm	mm			
160	18	18	38,50	1	000340318
200	20	20	57,00	1	000340320

39INOX

wedges,
made of stainless steel



L	A	S	€		
mm	mm	mm			
100	50	10	27,00	1	000390310
150	50	13	48,50	1	000390315
200	40	40	142,00	1	000390320

42INOX

combination wrenches
made of stainless steel



DIN 3113 - UNI ISO 7738

mm	L	€		
mm	mm			
6x6	95	13,50	2	000420306
7x7	105	14,00	2	000420307
8x8	116	14,10	2	000420308
9x9	127	15,20	2	000420309
10x10	137	16,00	2	000420310
11x11	148	17,30	2	000420311
12x12	158	18,10	2	000420312
13x13	169	18,30	2	000420313
14x14	180	18,90	2	000420314
15x15	190	19,50	2	000420315
16x16	201	20,10	2	000420316
17x17	212	22,60	2	000420317
18x18	222	24,20	2	000420318
19x19	233	26,00	2	000420319
21x21	254	32,00	1	000420321
22x22	264	33,00	1	000420322
24x24	285	36,00	1	000420324
27x27	290	105,00	1	000420327
30x30	320	128,00	1	000420330
32x32	340	139,50	1	000420332
36x36	360	195,50	1	000420336
38x38	430	209,00	1	000420338
41x41	430	245,50	1	000420341
46x46	480	282,00	1	000420343
50x50	520	303,00	1	000420345
55x55	560	329,00	1	000420347
60x60	595	365,00	1	000420350



42INOX/S11	204,50	1	000420391
6-8-10-11-12-13-14-15-16-17-19 mm			



42INOX/SC9	178,50	1	000420387
8-10-11-12-13-14-15-17-19 mm			
42INOX/SCV9	9,40	1	000420303

42INOX-AS

combination wrenches,
made of stainless steel



mm	L	€		
mm	mm			
1/4x1/4	95	16,20	1	000420356
5/16x5/16	116	16,40	1	000420358
3/8x3/8	137	19,70	1	000420360
7/16x7/16	148	21,20	1	000420361
1/2x1/2	169	21,80	1	000420363
9/16x9/16	180	23,50	1	000420364
5/8x5/8	201	24,70	1	000420366
11/16x11/16	212	28,50	1	000420367
3/4x3/4	233	31,50	1	000420369
13/16x13/16	254	36,00	1	000420371
7/8x7/8	264	37,50	1	000420372
15/16x15/16	285	43,00	1	000420373



42INOX-AS/S9	203,50	1	000420396
1/4-5/16-3/8-7/16-1/2-9/16-5/8-11/16-3/4			



96BPINOX

ball head offset hexagon key wrenches,
made of stainless steel



mm	L	L1	g	€		
mm	mm	mm				
2	91	22	4	4,75	4	000961441
2,5	91	22	6	4,75	4	000961442
3	101	24	11	5,05	4	000961443
4	112	29	19	5,60	4	000961444
5	131	33	32	6,70	4	000961445
6	154	36	51	7,40	4	000961446
7	164	40	65	9,65	2	000961447
8	175	44	116	11,70	2	000961448
10	197	51	189	14,60	2	000961450



96BPINOX/B6	47,00	1	000961455
2,5-3-4-5-6-8 mm			
96BPINOX/B9	76,00	1	000961456
2-2,5-3-4-5-6-7-8-10 mm			
96BPINOX/BV	5,70	1	000961459

96BPINOX-AS

ball head offset hexagon key wrenches,
made of stainless steel



mm	L	L1	g	€		
mm	mm	mm				
5/64	91	22	5,5	6,10	4	000961989
3/32	91	22	5,3	6,10	4	000961990
7/64	101	24	10,5	6,55	4	000961991
1/8	101	24	10,7	6,55	4	000961992
9/64	112	29	18,7	7,20	4	000961993
5/32	112	29	18,7	7,20	4	000961994
3/16	131	33	31,5	9,65	2	000961995
7/32	154	36	50,0	10,00	2	000961996
1/4	164	40	70,0	10,60	2	000961997
5/16	175	44	115,0	12,50	2	000961998
3/8	197	51	186,5	15,50	2	000961999



96BPINOX-AS/B8	74,50	1	000962000
5/64-3/32-1/8-5/32-3/16-7/32-1/4-5/16			
96BPINOX/BV	5,70	1	000961459

96TINOX

offset hexagon key wrenches,
with high-torque handles,
made of stainless steel

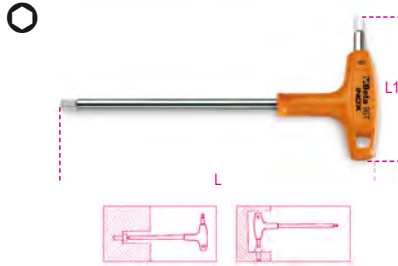

mm	L mm	L1 mm	€	🔧	📦
2,5	153	55	11,40	2	000961935
3	153	55	11,90	2	000961936
4	179	70	13,00	2	000961938
5	200	84	14,50	2	000961940
6	221	95	15,70	2	000961941
7	236	106	18,20	2	000961942
8	255	117	21,50	2	000961943
10	285	132	28,00	2	000961944



96TINOX/S5 2,5-3-4-5-6 mm	€ 66,50	🔧 1	📦 000961952
96TINOX/S8 2,5-3-4-5-6-7-8-10 mm	€ 134,00	🔧 1	📦 000961954

96TINOX-AS

offset hexagon key wrenches,
with high torque handles,
made of stainless steel

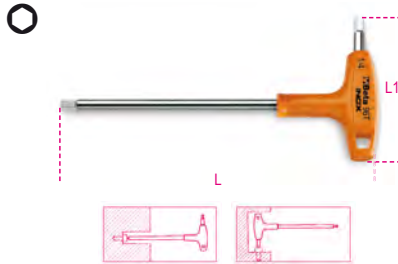

"	L mm	L1 mm	Ø mm	€	🔧	📦
3/32	153	55	3	12,50	2	000961861
7/64	153	55	4	12,80	2	000961862
1/8	179	70	4	14,40	2	000961863
9/64	179	70	5	14,70	2	000961864
5/32	200	84	6	15,40	2	000961865
3/16	200	84	6	16,60	2	000961866
7/32	221	103	7	19,30	2	000961867
1/4	236	106	8	20,20	2	000961868
5/16	255	117	10	24,60	2	000961869
3/8	285	132	12	27,00	2	000961870



96TINOX-AS/S7 3/32-1/8-5/32-3/16-7/32-1/4-5/16	€ 123,00	🔧 1	📦 000961877
--	----------	-----	-------------

111INOX

adjustable wrenches,
made of stainless steel



DIN 3117 - ISO 6787

L mm	L "	A max mm	A1 mm	€	🔧	📦
150	6	18	45	83,00	1	001110315
200	8	24	58	107,50	1	001110320
250	10	30	70	134,00	1	001110325

362INOX

heavy-duty pipe wrenches,
made of stainless steel



L mm	Ø max mm	€	🔧	📦
300	58	181,50	1	003620430

920INOX-A

hexagon hand sockets,
made of stainless steel



DIN 3124 - UNI ISO 2725

Ø mm	Ø mm	A mm	L mm	€	🔧	📦
8	15	10	40	29,50	2	009203008
9	16	10	40	31,00	2	009203009
10	17	10	40	32,50	2	009203010
11	18	11	40	34,50	2	009203011
12	19	11	40	36,50	2	009203012
13	20	11	40	39,00	2	009203013
14	21	11	40	41,00	2	009203014
15	23	11	40	43,00	2	009203015
16	24	11	40	45,00	2	009203016
17	25	11	40	46,00	2	009203017
18	26	13	42	48,00	2	009203018
19	28	13	42	50,00	2	009203019
20	29	13	42	53,50	1	009203020
21	30	13	43	54,00	1	009203021
22	31	15	43	54,50	1	009203022
24	34	15	43	63,50	1	009203024
27	38	18	46	77,50	1	009203027
30	42	20	46	92,00	1	009203030
32	44	20	46	104,00	1	009203032

920/55INOX

1/2" drive reversible ratchet,
72 teeth,
made of stainless steel



L mm	Ø mm	A mm	€	🔧	📦
264	40	43	220,00	1	009203882

920/R55INOX

12"
72



920/R55INOX	€ 78,00	🔧 1	📦 009203879
-------------	---------	-----	-------------

1048INOX

slip joint pliers, boxed joints,
made of stainless steel
• 7-position model

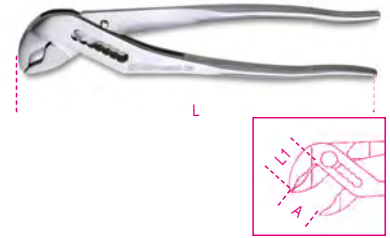

L mm	A max mm	L1 mm	€	🔧	📦
250	33	33	140,50	1	010480325

1082INOX

diagonal cutting nippers,
made of stainless steel

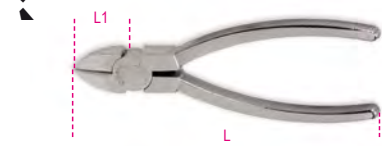

L mm	L1 mm	Ø mm	€	🔧	📦
150	20,0	1,6	101,50	1	010820350

1150INOX

heavy-duty combination pliers,
made of stainless steel
decentralized pin
open joint



L mm	L1 mm	€	🔧	📦
180	39	99,50	1	011500518

1153INOX

adjustable pliers, two positions,
made of stainless steel



L mm	L1 mm	€	🔧	📦
150	26	97,00	1	011530315

1290INOX

screwdrivers for slotted head screws
made of stainless steel



ISO 2380

SxAxL mm	L1 mm	Ø mm	€	🔧	📦
0,4x2,5x50	146	2,5	8,40	4	012900403
0,5x3x75	171	3,0	8,55	4	012900409
0,8x4x100	196	4,0	8,95	4	012900430
1,0x5,5x150	259	5,0	11,30	4	012900442
1,2x6,5x150	270	6,0	13,00	4	012900451

1292INOX

screwdrivers for cross head Phillips® screws,
made of stainless steel



ISO 8764

PHxDxL mm	L1 mm	€	🔧	📦
0x3x60	156	7,80	4	012920403
1x4,5x80	189	9,30	4	012920409
2x6x100	220	11,30	4	012920418

1293INOX/D8

screwdriver set
made of stainless steel



🔧	📦	€
1293INOX/D8	1	78,50
1290INOX		0,4x2,5x50-0,5x3x75 0,8x4x100-1,0x5,5x150- 1,2x6,5x150 mm
1292INOX		PH0x60-PH1x80 PH2x100 mm

1370INOX

engineer's hammer,
made of stainless steel



🔧	A mm	L mm	L1 mm	€	🔧	📦
500	25	240	101	87,50	1	013700375

1377INOX

ball pein hammers,
round heads,
for coppersmiths and tinsmiths,
made of stainless steel



🔧	L mm	L1 mm	€	🔧	📦
230	220	82	51,50	1	013770623
340	220	90	74,00	1	013770634

1730INOX

universal spatula,
made from stainless steel



A mm	L mm	€	🔧	📦
50	200	45,00	1	017300450

C20TSS

five-section cantilever tool box, made of AISI
304 stainless steel



🔧	📦	€
C20TSS	1	273,00

📏: 450x200x210 mm - 📊 4kg

Beta

C04TSS-7

mobile roller cab with seven drawers, made entirely of stainless steel,
Non-marking wheels

Main features:

- Seven drawers (570 x 410 mm) with ball bearing slides;
- 6 drawers, 83 mm high;
- 1 drawer, 170 mm high;
- 4 castors Ø 125 mm
- 2 fixed and 2 steering (two with brakes);
- Front centralized lock;
- Frame made entirely of stainless steel AISI 304
- Castors, supports, ball bearings, drawer interiors and guides made of stainless steel
- Drawer handles made of aluminium

63 kg

Beta
INOX
STAINLESS STEEL

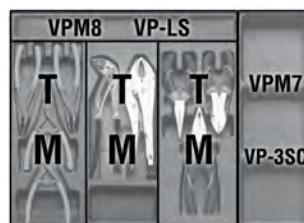

h	max
83 mm	25 kg
170 mm	30 kg

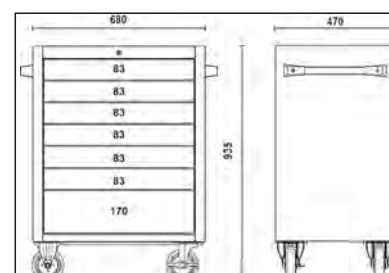
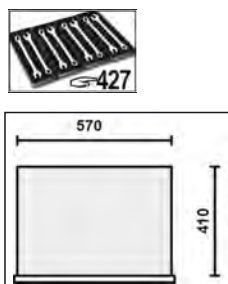

C04TSS/7

€ 2.450,00 1 024003077

SPARK-PROOF TOOLS



Copper-Berillium Cu-Be

The **Beta** spark-proof tools are specially designed for safe operations in environments subject to potential risk of explosion, in the presence of flammable liquids or gases, or for any applications that require using perfectly antimagnetic, corrosion-resistant tools.



The Beta sparkproof tools are certified by the Federal Institute for Materials Research and Testing, BAM, under European Directive 99/92/EC.



WARNING!
Risk of explosion in **ACETYLENE** environment

The mechanical characteristics of sparkproof tools differ from those of normal steel tools. Sparkproof tools should be used with extreme caution, avoiding overloads.

CLASSIFICATION OF AREAS SUBJECT TO EXPLOSION RISK

ATEX	MEDIUM-LOW	EXTREMELY LOW
GASES	<p>ZONE 1 An area in which an explosive atmosphere consisting of a mixture of air and flammable substances in the form of gas, vapour or mist is likely to occur in normal operation.</p>	<p>ZONE 2 An area in which an explosive atmosphere consisting of a mixture of air and flammable substances in the form of gas, vapour or mist is not likely to occur in normal operation but, if it does occur, will persist for a short period only.</p>
DUSTS	<p>ZONE 21 An area in which an explosive atmosphere in the form of a cloud of combustible dust in air is likely to occur in normal operation occasionally.</p>	<p>ZONE 22 An area in which an explosive atmosphere in the form of a cloud of combustible dust in air is not likely to occur in normal operation but, if it does occur, will persist for a short period only.</p>

30BA

sparkproof drift punches



Ø mm	L mm	S mm	€	🔧	📄
5	150	15	58,00	1	000300806
8	150	17	71,50	1	000300808
10	150	19	88,50	1	000300810

31BA

sparkproof pin punches



Ø mm	L mm	€	🔧	📄
3	110	25,50	1	000310853
4	110	54,50	1	000310854
6	115	83,00	1	000310856
8	120	94,00	1	000310858

31BA/C

sparkproof drift punches



Ø mm	Ø1 mm	L mm	€	🔧	📄
★6	12	150	34,00	1	000310876
★7	13	150	40,00	1	000310877
★12	18	175	85,00	1	000310882
★13	29	255	267,00	1	000310883

32BA

sparkproof centre punch



● mm	L mm	€	🔧	📄
14	150	80,00	1	000320811

34BA

sparkproof flat chisels



L mm	A mm	€	🔧	📄
200	22	108,50	1	000340801
250	24	181,50	1	000340803
300	25	244,00	1	000340802

39BA

sparkproof wedges



L mm	A mm	€	🔧	📄
150	40	47,00	1	000390801
230	40	159,00	1	000390802
250	40	249,50	1	000390803

42BA

sparkproof combination wrenches, open bi-hex ring ends



🔧 mm	L mm	€	🔧	📄
6x6	105	50,50	1	000420806
7x7	105	57,00	1	000420807
8x8	120	63,50	1	000420808
9x9	120	73,00	1	000420809
10x10	135	78,50	1	000420810
11x11	135	83,00	1	000420811
12x12	150	91,00	1	000420812
13x13	150	94,00	1	000420813
14x14	175	98,50	1	000420814
15x15	175	103,50	1	000420815
16x16	195	107,50	1	000420816
17x17	200	113,00	1	000420817
18x18	215	126,00	1	000420818
19x19	220	129,00	1	000420819
20x20	230	134,50	1	000420820
21x21	240	142,50	1	000420821
22x22	250	152,00	1	000420822
24x24	268	176,00	1	000420824
26x26	290	213,00	1	000420826
27x27	290	236,00	1	000420827
28x28	290	278,00	1	000420828
30x30	313	284,00	1	000420830
32x32	333	312,00	1	000420832
34x34	360	341,00	1	000420834
35x35	360	386,00	1	000420835
36x36	355	403,00	1	000420836
38x38	430	425,00	1	000420838
41x41	430	499,00	1	000420841
46x46	480	585,00	1	000420846
50x50	520	619,00	1	000420850
55x55	560	681,00	1	000420855
60x60	580	727,00	1	000420860
*65x65	595	829,00	1	000420865
*70x70	630	930,00	1	000420870

42BA-AS

sparkproof combination wrenches, open bi-hex ring ends



🔧 mm	L mm	€	🔧	📄
9/32x9/32	120	54,50	1	000420946
5/16x5/16	120	54,50	1	000420947
11/32x11/32	135	69,00	1	000420948
3/8x3/8	128	73,00	1	000420950
7/16x7/16	135	83,00	1	000420951
15/32x15/32	140	91,50	1	000420949
1/2x1/2	140	95,00	1	000420953
9/16x9/16	163	102,50	1	000420954

🔧 mm	L mm	€	🔧	📄
*19/32x19/32	195	123,50	1	000420955
5/8x5/8	177	124,50	1	000420956
11/16x11/16	195	133,00	1	000420957
3/4x3/4	215	136,00	1	000420959
13/16x13/16	230	159,00	1	000420961
7/8x7/8	235	165,50	1	000420962
15/16x15/16	256	183,50	1	000420964
*31/32x31/32	265	202,00	1	000420963
1x1	266	198,50	1	000420965
1.1/16x1.1/16	283	224,00	1	000420967
1.1/8x1.1/8	297	295,00	1	000420969
1.3/16x1.3/16	308	318,00	1	000420970
1.1/4x1.1/4	324	375,00	1	000420973
*1.7/16x1.7/16	360	454,00	1	000420976

55BA

sparkproof double open end wrenches



🔧 mm	L mm	€	🔧	📄
6x7	90	35,00	1	000550801
8x9	100	37,00	1	000550802
8x10	100	38,50	1	000550795
9x11	110	41,50	1	000550797
10x11	120	44,50	1	000550803
12x13	130	55,50	1	000550804
*12x14	130	67,00	1	000550846
13x14	133	66,50	1	000550799
14x15	145	67,00	1	000550805
14x17	150	71,50	1	000550806
16x17	165	72,50	1	000550807
17x19	170	95,00	1	000550847
18x19	170	97,00	1	000550809
*19x22	185	110,50	1	000550810
20x22	185	111,50	1	000550811
21x23	210	121,50	1	000550813
22x24	210	145,00	1	000550815
24x26	230	170,00	1	000550817
24x27	230	181,50	1	000550818
25x28	230	196,50	1	000550819
27x29	246	230,00	1	000550820
30x32	265	269,00	1	000550822
36x38	320	341,00	1	000550826
36x41	335	375,00	1	000550828
41x46	355	466,00	1	000550829
*46x50	370	533,00	1	000550830
*50x55	385	568,00	1	000550831
*55x60	415	704,00	1	000550832

55BA-AS

sparkproof double open end wrenches



🔧 mm	L mm	€	🔧	📄
3/8x7/16	110	45,50	1	000550853
1/2x9/16	130	54,50	1	000550854
5/8x11/16	160	80,00	1	000550857
3/4x13/16	180	98,50	1	000550859
7/8x15/16	210	138,50	1	000550865
1x1.1/16	230	187,50	1	000550868
1.1/8x1.3/16	245	244,00	1	000550870
1.1/4x1.5/16	255	289,00	1	000550872

58BA

sparkproof open end slogging wrenches



🔧 mm	L mm	€	🔧	📄
17	125	93,00	1	000580817
19	125	96,50	1	000580819
22	135	97,00	1	000580822
24	150	109,00	1	000580824
27	165	134,00	1	000580827
30	180	168,00	1	000580830
32	190	196,50	1	000580832
*34	200	225,00	1	000580834
36	210	233,00	1	000580836
38	220	256,00	1	000580838
41	230	289,00	1	000580841
46	240	346,00	1	000580846
50	255	392,00	1	000580850
*55	305	489,00	1	000580855
*60	315	568,00	1	000580860
*65	335	659,00	1	000580865
*70	370	795,00	1	000580870
*75	375	920,00	1	000580875
*80	400	1.101,00	1	000580880
*85	400	1.295,00	1	000580885
*90	445	1.540,00	1	000580890
*95	445	1.780,00	1	000580895
*100	485	2.060,00	1	000580900
*110	513	2.550,00	1	000580901

58BA-AS

sparkproof double open end slogging wrenches



🔧 mm	L mm	A mm	S mm	€	🔧	📄
*11/16	125	40,5	11,0	102,50	1	000580904
*3/4	125	40,5	11,0	104,50	1	000580905
*7/8	135	46,2	12,0	107,00	1	000580906
*15/16	150	50,3	12,0	122,50	1	000580907
*31/32	150	50,3	12,0	137,00	1	000580954
*1	175	56,9	15,0	142,00	1	000580908
*1.1/8	190	64,0	15,5	182,50	1	000580909
*1.1/4	190	64,0	15,5	214,50	1	000580910
*1.7/16	210	75,0	18,5	249,50	1	000580912
*1.1/2	220	82,0	18,5	296,00	1	000580913
*1.5/8	230	86,8	18,5	318,00	1	000580914
*1.3/4	250	98,0	20,	403,00	1	000580970

78BA

sparkproof bi-hex ring slogging wrenches



🔧 mm	L mm	€	🔧	📄
17	145	97,00	1	000780817
19	145	106,50	1	000780819
22	165	108,50	1	000780822
24	140	133,00	1	000780824
27	155	152,00	1	000780827
30	165	176,00	1	000780830
32	180	190,50	1	000780832
34	192	210,00	1	000780834
36	208	233,00	1	000780836
38	215	272,00	1	000780838
41	225	324,00	1	000780841
46	245	363,00	1	000780846
50	250	420,00	1	000780850
55	265	489,00	1	000780855
60	275	528,00	1	000780860
65	295	568,00	1	000780865

mm	L mm	€		
70	310	642,00	1	000780870
75	325	721,00	1	000780875
80	340	772,00	1	000780880
*85	355	982,00	1	000780885
*90	380	1.158,00	1	000780890
*95	390	1.340,00	1	000780895
*100	410	1.530,00	1	000780900
*105	420	1.690,00	1	000780903
*110	445	1.930,00	1	000780901
*120	480	2.280,00	1	000780902

78BA-AS

sparkproof bi-hex ring slugging wrenches



"	L mm	€		
11/16	145	96,00	1	000780908
3/4	145	99,50	1	000780909
7/8	155	111,50	1	000780935
15/16	165	123,50	1	000780936
*31/32	165	144,00	1	000780937
1	175	144,00	1	000780938
*1.1/16	175	171,00	1	000780939
1.1/8	180	172,50	1	000780940
1.3/16	185	179,50	1	000780941
1.1/4	177	195,50	1	000780910
*1.5/16	200	198,50	1	000780954
*1.3/8	205	207,50	1	000780911
1.7/16	208	259,00	1	000780912
*1.1/2	215	270,00	1	000780913
*1.9/16	225	335,00	1	000780947
*1.11/16	225	353,00	1	000780962
1.5/8	225	329,00	1	000780914
*1.3/4	235	363,00	1	000780963
1.13/16	243	375,00	1	000780916
1.7/8	235	425,00	1	000780915
2	254	442,00	1	000780918
2.3/16	264	516,00	1	000780920
2.3/8	275	562,00	1	000780922
*2.9/16	286	585,00	1	000780924
*2.15/16	311	709,00	1	000780926
*3.1/8	325	823,00	1	000780928
*3.1/2	355	1.039,00	1	000780930

89BA

spark-proof single ring wrenches



mm	L mm	€		
10	200	110,00	1	000890810
11	210	114,50	1	000890811
12	220	118,00	1	000890812
13	230	121,50	1	000890813
14	240	123,50	1	000890814
16	260	133,00	1	000890816
17	270	137,00	1	000890817
18	280	148,00	1	000890818
19	300	153,00	1	000890819
20	310	190,50	1	000890820
22	330	190,50	1	000890822
24	350	209,00	1	000890824
27	370	258,00	1	000890827
30	400	289,00	1	000890830
32	420	304,00	1	000890832

90BA

sparkproof double ended offset ring wrenches



mm	L mm	€		
6x7	122	35,50	1	000900801
8x9	128	45,50	1	000900802
10x11	155	51,50	1	000900803
12x13	175	60,50	1	000900806
12X14	180	64,50	1	000900807
14x15	200	72,50	1	000900808
14x17	220	74,00	1	000900809
16x17	230	86,50	1	000900811
16x18	235	86,50	1	000900812
17X19	250	89,50	1	000900814
18x19	265	98,50	1	000900815
19x22	280	103,50	1	000900817
20x22	295	117,00	1	000900818
21x23	298	124,50	1	000900820
22x24	315	150,00	1	000900821
24x26	333	193,00	1	000900822
24x27	340	193,00	1	000900823
30x32	395	284,00	1	000900824
34x36	410	403,00	1	000900826
*36x41	450	545,00	1	000900828
*41x46	470	670,00	1	000900829
*46x50	490	743,00	1	000900830

91BA

sparkproof heavy duty offset ring wrenches



mm	Ø mm	€		
24	38	233,00	1	000910824
27	42	278,00	1	000910827
30	48	318,00	1	000910830
32	49	355,00	1	000910832
36	54	386,00	1	000910836
41	62	432,00	1	000910841
*46	69	573,00	1	000910846
*50	75	613,00	1	000910850
*55	82	709,00	1	000910855

92BA

sparkproof tubes for item 91BA



	L mm	91BA mm	Ø mm	€		
92BA/1	460	24÷30	25	275,00	1	000920810
92BA/2	610	32÷41	28	355,00	1	000920820
*92BA/3	760	46÷55	32	477,00	1	000920830

93BA

ratcheting double-ended offset ring wrench for scaffolding bolts, sparkproof



mm	L mm	€		
21x22	345	573,00	1	000930821

95BA

double ended flat ring wrenches, sparkproof



mm	L mm	€		
7x9	115	35,00	1	000950801
8x10	115	38,50	1	000950802
10x11	140	43,00	1	000950804
10x12	140	50,50	1	000950805
12x14	145	58,00	1	000950806
14x17	165	69,00	1	000950807
*16x18	170	90,00	1	000950809
*17x19	185	78,50	1	000950808
*18x19	185	98,50	1	000950810
*19x22	200	122,50	1	000950812
*21x23	230	135,00	1	000950815
*24x27	255	172,50	1	000950817
*30x32	295	259,00	1	000950820

96BA

sparkproof offset hexagon key wrenches

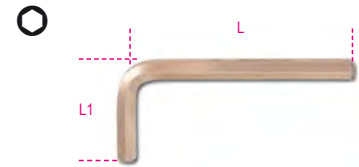

mm	L mm	L1 mm	€		
1,5	50	17	71,50	1	000960760
2	50	16	73,00	1	000960762
2,5	56	20	78,00	1	000960761
3	63	21	79,50	1	000960763
4	69	25	84,00	1	000960764
5	78	29	86,50	1	000960765
6	88	33	88,50	1	000960766
7	93	34	93,00	1	000960767
8	97	36	98,50	1	000960768
9	104	37	103,00	1	000960769
10	110	39	106,50	1	000960770
11	118	42	113,50	1	000960771
12	122	44	129,50	1	000960772
14	150	58	145,00	1	000960774
15	156	60	153,00	1	000960775
16	162	63	168,00	1	000960776
17	168	65	176,00	1	000960777
19	177	72	197,50	1	000960779
22	186	77	231,50	1	000960802
24	192	82	267,00	1	000960804

96BA/BP

ball head offset hexagon key wrenches, sparkproof



mm	L mm	L1 mm	€		
1,5	50	16	73,50	1	000961800
2	50	16	74,00	1	000961801
2,5	63	20	83,50	1	000961802
3	60	20	84,00	1	000961803
3,5	70	25	87,00	1	000961799
4	66	25	87,50	1	000961804
5	75	28	89,50	1	000961805
6	84	32	92,50	1	000961806
8	92	36	100,50	1	000961808
10	102	40	108,50	1	000961810
12	113	45	134,00	1	000961812

96BAF-AS

sparkproof offset hexagon key wrenches



mm	L mm	L1 mm	€	🔧	🚚
*1/16	59	25	58,00	1	000962831
*5/64	59	25	60,00	1	000962832
*3/32	59	25	62,50	1	000962833
*7/64	59	25	65,00	1	000962834
*1/8	59	25	67,50	1	000962835
*9/64	64	29	73,00	1	000962836
*5/32	65	30	75,50	1	000962837
*3/16	79	31	79,50	1	000962838
*7/32	85	37	83,00	1	000962839
*1/4	85	37	86,50	1	000962840
*5/16	92	44	93,50	1	000962842
*3/8	110	45	101,50	1	000962844
*7/16	119	48	108,50	1	000962845
*1/2	140	55	133,00	1	000962846
*9/16	150	58	152,00	1	000962847

99BA

sparkproof hook wrenches with square noses, for ring nuts UNI/ISO 2982, 2983



mm	A mm	€	🔧	🚚
32-75	4,0	188,50	1	000990803
50-120	4,5	296,00	1	000990805
115-170	4,5	477,00	1	000990811

110BA

sparkproof adjustable wrenches



L mm	A max mm	€	🔧	🚚
100	13	139,50	1	001100810
150	18	160,00	1	001100815
200	24	188,50	1	001100820
250	30	227,00	1	001100825
300	36	319,00	1	001100830
375	46	430,00	1	001100837
*450	55	602,00	1	001100845
*600	65	1.005,00	1	001100860

330BA

sparkproof pipe cutters for gas pipes



330BA/2	Ø max mm	L mm	€	🔧	🚚
	50	375	733,00	1	003300802

330BA/2R

spare pin and knife for gas pipe cutter 330BA, sparkproof



330BA/2-R	€	🔧	🚚
	74,00	1	003300822

363BA

sparkproof heavy duty pipe wrenches



L mm	Ø max mm	max mm	€	🔧	🚚
150	1 1/2" gas	20	237,00	1	003630815
200	1" gas	30	238,00	1	003630820
250	1 1/2" gas	49	278,00	1	003630825
300	2" gas	60	353,00	1	003630830
350	2" gas	60	437,00	1	003630835
450	2 1/2" gas	76	664,00	1	003630845
600	3" gas	90	925,00	1	003630860

378BA

sparkproof pipe wrench, Swedish pattern, made from copper/beryllium alloy



L mm	Ø max mm	€	🔧	🚚
430	1" 1/2" gas	723,00	1	003780800
530	2" gas	891,00	1	003780801

386BA

sparkproof heavy duty reversible chain pipe wrenches

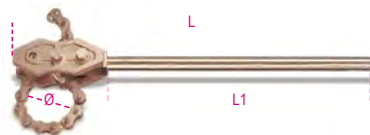

L mm	Ø max mm	L1 mm	€	🔧	🚚
600	100	470	1.091,00	1	003860806
900	200	750	1.815,00	1	003860809

911BA

bi-hex hand sockets, spark-proof

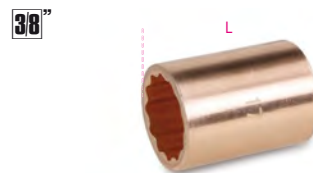

mm	L mm	€	🔧	🚚
6	28	48,00	1	009110806
7	28	51,50	1	009110807
8	28	55,50	1	009110808
9	28	59,00	1	009110809
10	32	80,00	1	009110810
11	32	84,50	1	009110811
12	32	89,00	1	009110812
13	32	93,00	1	009110813
14	32	99,00	1	009110814
15	32	99,50	1	009110815
16	32	104,50	1	009110816
17	32	108,50	1	009110817
18	32	110,00	1	009110818
19	32	114,50	1	009110819

911BA/16

adaptor, 3/8" female and 1/2" male drives, spark-proof



L mm	3/8"	1/2"	€	🔧	🚚
34			101,50	1	009110836

911BA/20

extension bar, 3/8" male and female drives, spark-proof



L mm	€	🔧	🚚
75	82,00	1	009110840

911BA/55

3/8" push-through drive ratchet, spark-proof

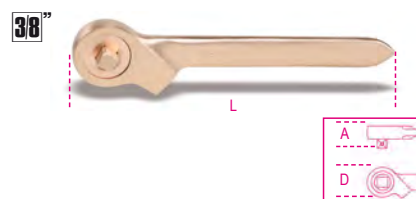

L mm	D mm	A mm	€	🔧	🚚
200	45	16,5	174,50	1	009110882

 **Beta**

921BA

sparkproof bi-hex sockets

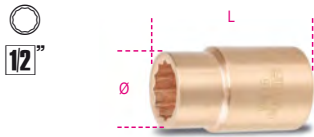

mm	Ø mm	L mm	€		
8	24,0	40	72,50	1	009210808
9	24,0	40	76,50	1	009210809
10	16,5	40	87,00	1	009210810
11	17,5	40	90,00	1	009210811
12	18,5	40	96,00	1	009210812
13	19,5	40	101,50	1	009210813
14	20,0	40	103,50	1	009210814
15	21,5	40	107,50	1	009210815
16	24,0	40	111,00	1	009210816
17	25,0	40	115,50	1	009210817
18	25,0	40	119,50	1	009210818
19	28,0	42	123,50	1	009210819
20	29,0	42	129,50	1	009210820
21	30,0	43	132,00	1	009210821
22	30,5	43	137,00	1	009210822
24	34,0	43	161,00	1	009210824
25	36,0	43	174,50	1	009210825
26	37,5	43	186,50	1	009210826
27	37,5	45	195,50	1	009210827
28	38,9	46	204,50	1	009210828
30	41,5	46	230,00	1	009210830
32	43,5	46	253,00	1	009210832

921BA-AS

sparkproof bi-hex sockets

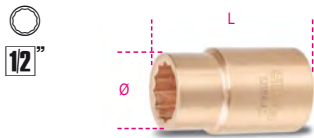

"	Ø mm	L mm	€		
5/16	24,0	40	77,00	1	009210958
3/8	24,0	40	83,50	1	009210960
7/16	24,0	40	91,00	1	009210961
1/2	24,0	40	97,00	1	009210963
9/16	24,0	40	101,50	1	009210964
5/8	25,0	40	115,50	1	009210966
11/16	25,5	40	124,50	1	009210967
3/4	28,0	42	137,00	1	009210969
13/16	30,0	43	145,00	1	009210971
7/8	31,5	43	158,00	1	009210972
15/16	34,0	43	167,00	1	009210974
1	36,0	43	186,50	1	009210975
1.1/16	38,0	46	200,50	1	009210977
1.1/4	42,0	46	267,00	1	009210982
1.7/16	50,5	50	329,00	1	009210986

921BA/15

adaptor,
1/2" female and 3/8" male drives,
spark-proof



L mm	1/2	3/8	€		
34	1/2	3/8	92,00	1	009210839

921BA/16

adaptor, 1/2" female and 3/4" male
drives, sparkproof

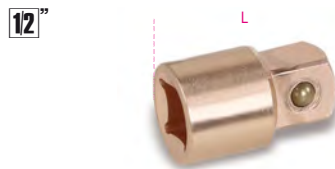

L mm	1/2	3/4	€		
34	1/2	3/4	120,50	1	009210840

921BA/21- 921BA/22

sparkproof 1/2" wobble extension bars



	L mm	Ø mm	€		
921BA/21	125	30	122,50	1	009210842
921BA/22	250	31	171,00	1	009210844

921BA/25

sparkproof 1/2" drive universal joint



L mm	Ø mm	1/2	1/2	€		
80	25	1/2	1/2	124,50	1	009210845

921BA/42

sparkproof 1/2" drive sliding T handle

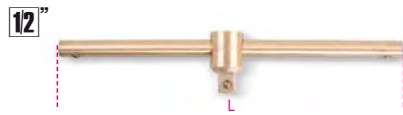

L mm	1/2	€		
250	1/2	202,00	1	009210846

921BA/50

sparkproof 1/2" drive
push-through square ratchet



L mm	D mm	A mm	€		
250	45	16,5	233,00	1	009210850

921BA/R50

sparkproof
spare set



1/2"	€		
1/2"	69,00	1	009210851

926BA

sparkproof bi-hex hand sockets

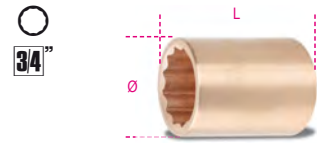

mm	Ø mm	L mm	€		
22	40	55	152,00	1	009260822
24	40	55	170,00	1	009260824
26	40	55	193,00	1	009260826
27	40	55	204,50	1	009260827
28	41	55	238,00	1	009260828
30	43	60	244,00	1	009260830
32	45	60	272,00	1	009260832
34	48	60	290,00	1	009260834
36	50	60	314,00	1	009260836
38	53	60	335,00	1	009260838
41	57	65	368,00	1	009260841
46	63	65	437,00	1	009260846
50	68	70	479,00	1	009260850

926BA/15

adaptor, 3/4" female and 1/2" male
drives, sparkproof



L mm	3/4	1/2	€		
55	3/4	1/2	120,50	1	009260861

926BA/22

sparkproof 3/4" drive extension bars



926BA/22	L mm	Ø mm	€		
926BA/22	200	38	244,00	1	009260872

926BA/42

sparkproof 3/4" drive slide T-handle



L mm	3/4	€		
400	3/4	353,00	1	009260876

926BA/50

sparkproof 3/4" push-through drive ratchet



L mm	D mm	A mm	€	1	009260880
300	61	22	363,00	1	009260880

926BA/R50

sparkproof spare set



3/4"	€	1	009260881
	115,50	1	009260881

937BA

hexagon socket wrenches, sparkproof



mm	L mm	A mm	€	1	009370813
13	240	45	90,00	1	009370813
17	260	51	130,50	1	009370817
19	270	55	136,00	1	009370819
22	278	59	178,50	1	009370822
24	286	63	190,50	1	009370824
27	294	69	203,00	1	009370827
30	302	75	224,00	1	009370830
32	310	81	244,00	1	009370832
*36	330	85	287,00	1	009370836
*41	350	90	347,00	1	009370841

951BA

T-handle wrenches with hexagon male ends, sparkproof



mm	L mm	L1 mm	€	1	009510904
4	100	90	152,00	1	009510904
5	100	90	159,00	1	009510905
6	100	90	168,00	1	009510906

961BA

sparkproof scrapers



L mm	A mm	€	1	009610802
250	39	134,00	1	009610802
350	55	202,00	1	009610806

963BA

sparkproof pry bars with pointed and flat bent ends



L mm	A mm	€	1	009630801
500	24	374,00	1	009630801
*800	24	587,00	1	009630803
*1000	30	1.245,00	1	009630805

964BA

sparkproof wrench bungs



L mm	€	1	009640801
385	353,00	1	009640801

964BA/L

universal shears for barrels, sparkproof

For opening edged metal barrels



*964BA/L	L mm	€	1	009640821
	510	1.785,00	1	009640821

965BA

safety valve wrenches, sparkproof



A mm	A1 mm	L mm	€	1	009650830
30	44	200	155,00	1	009650830
32	50	300	216,00	1	009650832
35	47	250	176,00	1	009650835
40	50	300	203,00	1	009650840
45	58	350	262,00	1	009650845
48	62	375	272,00	1	009650848
50	67	400	299,00	1	009650850
55	73	450	358,00	1	009650855
60	79	500	386,00	1	009650860
*65	82	550	432,00	1	009650865
*70	85	600	477,00	1	009650870

966BA

sparkproof safety valve wrench

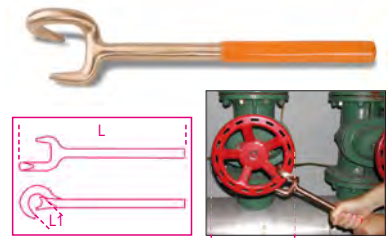

L mm	L1 mm	Ø min= max mm	€	1	009660801
350	40	50÷150	339,00	1	009660801

966BA/V

sparkproof safety valve wrenches

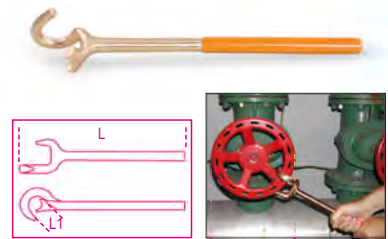

L mm	L1 mm	Ø min= max mm	€	1	009660812
370	36	125÷250	339,00	1	009660812
430	48	250÷400	489,00	1	009660814

1032BA

sparkproof internal circlip pliers, straight pattern, PVC-coated handles



L mm	Ø mm	€	1	010320820
200	40÷100	221,00	1	010320820

1036BA

sparkproof external circlip pliers, straight pattern, PVC-coated handles



L mm	Ø mm	€	1	010360820
200	40÷100	221,00	1	010360820

1046BA

sparkproof slip joint pliers

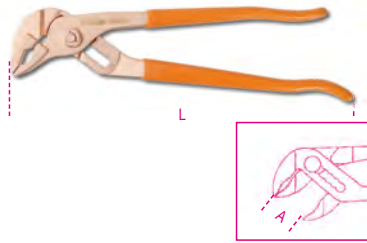

L mm	A max mm	€	🔧	📄
250	32	289,00	1	010460801
*300	52	380,00	1	010460803

1052BA

adjustable self-locking pliers,
concave jaws, sparkproof

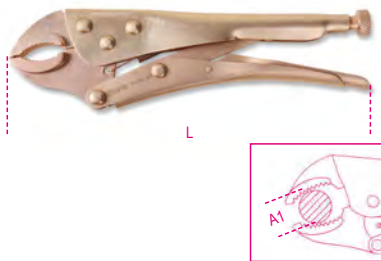

L mm	A1 max mm	€	🔧	📄
225	40,0	284,00	1	010520824

1082BA

sparkproof diagonal cutting nippers

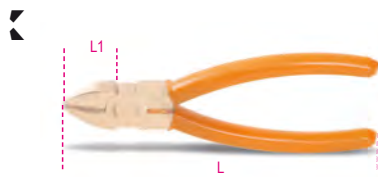

L mm	L1 mm	€	🔧	📄
160	22	206,50	1	010820801

1100BA

bolt cutters,
spark-proof



L mm	€	🔧	📄
600	1.480,00	1	011000860

1137BA

blasting pliers



L mm	L1 mm	€	🔧	📄
185	30	384,00	1	011370801

1137BA/RC

spare blade for item 1137BA



1137BA/RC	€	🔧	📄
	74,00	1	011370851

1150BA

sparkproof combination pliers

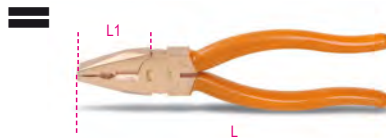

L mm	L1 mm	€	🔧	📄
200	40	243,00	1	011500820

1162BA

sparkproof extra-long flat knurled nose pliers



L mm	L1 mm	€	🔧	📄
150	54	190,50	1	011620815

1166BA

sparkproof extra-long needle knurled nose pliers



L mm	L1 mm	€	🔧	📄
150	54	190,50	1	011660815

1270BA

sparkproof screwdrivers for slotted head screws



AxL mm	L1 mm	€	🔧	📄
3x75	178	35,00	1	012700803
4x100	209	43,00	1	012700804
5x150	250	57,00	1	012700805
6x150	270	60,50	1	012700806
10x250	382	92,00	1	012700810
8x200	312	68,50	1	012700808

1272BA

sparkproof screwdrivers
for cross head Phillips® screws



PHxDxL mm	L1 mm	€	🔧	📄
1x5x100	209	47,50	1	012720801
2x6x150	270	61,00	1	012720802
3x8x200	332	73,50	1	012720803

1277BA

screwdrivers for Torx® head screws,
sparkproof



Ø	L mm	L1 mm	Ø mm	€	🔧	📄
T10	75	184	5	45,50	1	012770810
T15	75	184	5	49,00	1	012770815
T20	100	209	6	66,50	1	012770820
T25	125	209	6	70,00	1	012770825
T30	150	270	6	77,00	1	012770830
T40	200	332	8	102,50	1	012770840

1370BA

sparkproof engineer's hammers,
wooden shafts



g	A mm	L mm	L1 mm	€	🔧	📄
500	30	310	108	127,50	1	013700805
1000	35	340	137	225,00	1	013700810

1370BA/MR

spare shafts for item 1370BA

	€		
1370BA/MR 500	21,50	1	013700865
1370BA/500			
1370BA/MR 1000	26,50	1	013700870
1370BA/1000			

1370BA/PL

sparkproof engineer's hammers, fibre shafts



g	A mm	L mm	L1 mm	€		
500	30	310	108	127,50	1	013700815
1000	35	340	137	225,00	1	013700820

1375BA/PL

sparkproof ball pein and claw hammer, wooden shaft



g	L mm	L1 mm	Ø mm	€		
680	321	125	30	164,50	1	013750800

1377BA

sparkproof ball pein hammer, round head, for coppersmiths and tinsmiths



g	L1 mm	L mm	€		
340	90	280	82,00	1	013770834

1377BA/PL

sparkproof ball pein hammer, round head, for coppersmiths and tinsmiths



g	L1 mm	L mm	€		
340	90	280	82,00	1	013770884

1379BA

sparkproof scraping hammer, wooden shaft



g	L1 mm	L mm	€		
500	142	315	159,00	1	013790850

1380BA

sparkproof lump hammers, wooden shafts



g	L1 mm	L mm	€		
1000	100	400	275,00	1	013800810
1500	118	400	335,00	1	013800815
2000	126	400	442,00	1	013800820

1380BA/MR

spare shafts for item 1380BA

	€		
1380BA/MR 1000	28,00	1	013800860
1380BA/1000			
1380BA/MR 1500	28,00	1	013800865
1380BA/1500			
1380BA/MR 2000	28,00	1	013800870
1380BA/2000			

1380BA/PL

sparkproof mason club hammers, fibre shafts



g	L1 mm	L mm	€		
500	80	310	137,00	1	013800955
1000	94	350	256,00	1	013800960
1500	115	400	368,00	1	013800965
2000	125,5	400	482,00	1	013800970

1381BA

sparkproof sledge hammers, wooden shafts



g	L1 mm	L mm	€		
5000	179	900	1.028,00	1	013810850
*8000	190	900	1.650,00	1	013810858

1381BA/MR

spare shaft for item 1381BA

	€		
1381BA/MR 5000	43,00	1	013810870
1381BA/5000			
*1381BA/MR 8000	49,50	1	013810878
1381BA/8000			

1381BA/PL

sparkproof sledge hammers, fibre shafts



g	L1 mm	L mm	€		
5000	172	900	943,00	1	013810885
8000	204	900	1.690,00	1	013810888

1390BA

spark-proof soft face hammer



Ø mm	L mm	L1 mm	€		
*52	370	130	221,00	1	013900805

1390BA/R

spare nylon faces for item 1390BA



D mm	€		
52	45,00	4	013900885



1602BA

sparkproof crimping pliers
for insulated terminals,
lightweight series



mm ²	L mm	€	Hand	Code
0.75+6	200	271,00	1	016020801

1701BA

sparkproof hexagon chisels



L mm	A mm	S mm	€	Hand	Code
150	12	10	50,00	1	017010810
200	16	14	80,00	1	017010814
250	18	14	98,50	1	017010815
350	19	17	259,00	1	017010817

1703BA/A

sparkproof axe



L mm	L1 mm	A mm	€	Hand	Code
340	145	82	225,00	1	017030082

1703BA/P

sparkproof pick



A mm	L mm	L1 mm	€	Hand	Code
56	1050	410	588,00	1	017030150

1703BA/PL

sparkproof shovel



A mm	L1 mm	L mm	€	Hand	Code
240	420	990	494,00	1	017030200

1717BA

sparkproof rigid spatulas



A mm	€	Hand	Code
60	120,50	1	017170801
80	134,00	1	017170803

1717BA/1

sparkproof wall scraper



A mm	L mm	€	Hand	Code
100	220	240,50	1	017170805

1719BA8

sparkproof files, 8"



	L mm	€	Hand	Code
1719BA8/P	200	148,00	1	017190801
1719BA8/M	200	153,00	1	017190805
1719BA8/R	200	156,00	1	017190810
1719BA8/T	200	144,00	1	017190815
1719BA8/Q	200	144,00	1	017190820

1719BA12

sparkproof files, 12"



	L mm	€	Hand	Code
1719BA12/P	300	267,00	1	017190831

1727BA

sparkproof hacksaw and blade



L mm	L1 mm	€	Hand	Code
500	300	471,00	1	017270801

1728BA

spark-proof blades for hacksaw frames, made
from copper-beryllium alloy



L mm	€	Hand	Code
300	91,50	1	017280801

1737BA

brush with sparkproof wires



L mm	A mm	€	Hand	Code
294	29	61,00	1	017370801

1758BA

sparkproof funnel



Ø mm	H mm	€	Hand	Code
160	150	85,00	1	017580815

1776BA

sparkproof knife



L1 mm	L mm	€	Hand	Code
145	250	133,00	1	017760801

1784BA

sparkproof scissors



L mm	€	Hand	Code
225	230,00	1	017840822



1972/12

ultracompact drill, 12V

- ultracompact, no more than 176 mm in length; ultralightweight, no more than 1.1 kg, with battery, perfectly balanced
- double mechanical speed with steel gears and 18-position clutch
- torque up to 34 Nm and 1500 rpm (350 rpm in 1st gear); drills diameters up to 10 mm in steel and 20 mm in wood
- 2Ah batteries and charge indicator on drill body
- triple battery self-protection (heat, overload and monitoring of charge differences (if any) between cells) for increased safety and durable high performance
- ergonomic nonslip handle
- front LED
- 10-mm autochuck
- belt clip (right/left side)
- selector switch, screwing-unscrewing-locking modes (for transportation)
- supplied in a hard case with 2 lithium ion batteries (2 Ah) and quick charger (45 min)

1,1 kg

1972/12

€ 363,00



1



019720012



Beta
**3-YEAR
WARRANTY**



1984/18QM

reversible impact wrench, 18V, brushless

digital brushless motor: remarkably enhanced performance, including: increased power, reduced energy consumption, extended useful motor life, outstanding compactness, improved power proportioning from push button.

- 5Ah batteries with charge indicator
- ultracompact: no more than 196 mm in length
- 1/2" male drive with bush retaining ring
- belt clip (right/left side)
- triple front LED
- gearcase made entirely of metal
- selector switch, screwing-unscrewing-locking modes (for transportation)
- ergonomic nonslip handle
- triple battery self-protection (heat, overload and monitoring of charge differences (if any) between cells) for increased safety and durable high performance

4 modes available:

1: 270Nm; 1400 RPM

2: 360Nm; 2000 RPM

3: 450Nm; 2750 RPM

A: 450Nm Autostop - as long as the impact wrench detects a free rotation, it applies maximum torque/speed (450Nm; 2750 RPM)

when the nut reaches the end of stroke and stops rotating, the impact wrench keeps applying maximum torque for 1 second; then it sets itself to the lowest level, to avoid damaging the nut

- supplied in a hard case with hexagon bit holder adaptor (1/4"), 2 lithium ion batteries (5 Ah) and quick charger (80 min)

2,3 kg

1984/18QM

€ 1.022,00



1



019840018



Beta
**3-YEAR
WARRANTY**

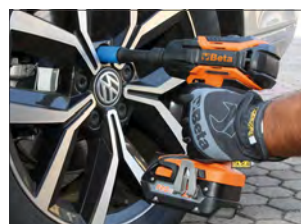



PNEUMATIC TOOLS

For over 20 years Beta Utensili has supplemented its products with a comprehensive range of pneumatic tools and accessories developed for the automotive and industrial maintenance markets: impact wrenches, ratchets, drills, grinders, sanders and many more items.

During this period close co-operation with professional users has been key to ongoing growth. It is on the basis of such growth that Beta's pneumatic tools can boast an excellent reliability/performance ratio.

In order to satisfy market requirements in the best possible way, Beta Utensili repairs the pneumatic tools in its Quality Department.



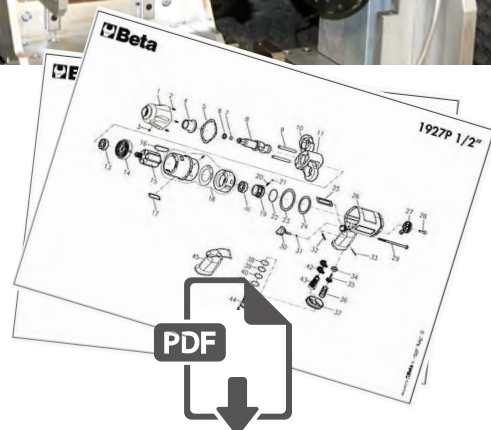
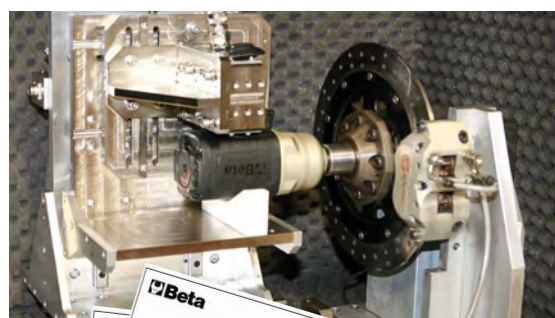























This process has allowed the company to improve its know-how to a significant extent and become increasingly responsive to the customer base.



www.beta-tools.com













GUIDE TO CHOOSING PNEUMATIC TOOLS

IMPACT WRENCHES



■	BETA ITEM	N °	MATERIAL	 max. Nm	 db (A) LpA	 db (A) LpW	 I/min.	 kg	MECHANISM	 m/s ²
3/8"		1924F	Aluminium	108	93.6	104.6	59	0,5	Double hammer	6.85
3/8"		1924B	Aluminium	353	91	95	80	1,5	Pin clutch	7.9
3/8"		1924CD	Composite material	410	91.7	102.7	79	1,3	Double hammer	6.2
1/2"		1927AN	Aluminium	244	89.4	100.4	190	2,1	Single hammer	8.63
1/2"		1927G	Aluminium	325	92.2	103.2	113	1,2	Single hammer	9.96
1/2"		1927B	Aluminium	705	98.0	109.0	133	2,1	Pin clutch	14.08
1/2"		1927XM	Aluminium	770	102	113	122	1,3	Single hammer	7.5
1/2"		1927CD	Composite material	1.020	95.5	106.5	130	2,3	Double hammer	7.2
1/2"		1927P	Composite material	1.750	95.1	106.1	290	2,0	Double hammer	6.7
3/4"		1928XM	Aluminium	1.600	91.8	102.8	175	2,9	Double hammer	12.96
3/4"		1928DA	Aluminium	1.695	96	99.5	300	4,3	Double hammer	3.6
3/4"		1928DAL	Aluminium	1.695	96	99.5	300	4,8	Double hammer	3.6
3/4"		1928CD	Composite material	1.800	97.5	108.5	215	3,5	Double hammer	11.4
1"		1930CD	Composite material	2.445	95.6	97.1	410	7,1	Double hammer	3,6
1"		1930PA	Aluminium	2.445	96.0	97.1	410	9,6	Double hammer	7,2
1"		1930A	Aluminium	2.445	103.3	114.3	460	9,5	Double hammer	67
1"		1930LH	Aluminium	2.441	97.1	108.1	282	7,1	Double hammer	17.4
1"		1930LA	Aluminium	2.445	95.6	97.1	460	10,6	Double hammer	3,6
1"		1930HLA	Aluminium	3.661	99	101	460	16,4	Double hammer	16,4
1 1/2"		1930ZL	Aluminium	4.068	102.4	113.4	480	15	Double hammer	69.6

GUIDE TO CHOOSING PNEUMATIC TOOLS

AIR IMPACT RATCHETS

■	BETA ITEM	N°.	 max. Nm	 db (A) LpA	 db (A) LpW	 l/min.	 kg	 m/s ²
14"		1921B1	24	96	85	90	0,4	2.6
14"		1921M1	27	84	88	96	0,6	1.8
14"		1922P1	68	90.6	101.6	88	0,6	8.61
38"		1921M2	27	84	88	96	0,6	1.8
38"		1922P2	68	90.6	101.6	88	0,6	8.61
12"		1921N3	68	80	87	140	1,2	2.6
12"		1922P3	136	94.9	105.9	113	1,5	18.28

GRINDERS

	BETA ITEM	N°.	POWER	 db (A) LpA	 db (A) LpW	 l/min.	 kg	 m/s ²
		1933	0,20 kW	80.0	87.0	230	0,38	4.53
		1933L	0,20 kW	80.0	87.0	270	0,67	1.15
		1933AN90	0,20 kW	80.0	87.0	230	0,51	1.24
		1933I	0,38 kW	80.0	87.0	260	0,67	4.53
		1933IL	0,38 kW	79.0	97.0	113	1,4	1.6
		1933IH	0,75 kW	88.1	99.1	370	0,8	2.6
		1933ILH	0,75 kW	85.7	96.7	370	1,2	1.4
		1933AN90-H	0,75 kW	85.6	96.6	370	1,1	6.7
		1934MAV	0,04 kW	71	76	115	0,2	2.5
		1934MAV70	0,08 kW	80	87	115	0,2	4

1921B1

baby reversible air ratchet

1/4"

CE



Free speed	350 rpm
Max. torque	24 Nm
Bolt capacity	CI 8.8 M7 ● 11 mm
Bolt capacity	CI 12.9 M6 ● 10 mm
Air inlet	1/4" GAS
Working pressure	6,2 bar
Internal hose size (Ø)	8 mm
Mean air consumption	68 l/min
Weight	0,4 kg

1/4	€ 232,00	1	019210001
-----	----------	---	-----------

1921M1

compact reversible air ratchet

• Knob speed regulator

1/4"

CE



Free speed	200 rpm
Max. torque	27 Nm
Bolt capacity	CI 8.8 M7 ● 11 mm
Bolt capacity	CI 12.9 M6 ● 10 mm
Air inlet	1/4" GAS
Working pressure	6.2 bar
Internal hose size (Ø)	8 mm
Mean air consumption	96 l/min
Weight	0.6 kg

1/4	kg 0,6	€ 205,00	1	019210005
-----	--------	----------	---	-----------

1921M2

compact reversible air ratchet

• Knob speed regulator

3/8"

CE



Free speed	200 rpm
Max. torque	27 Nm
Bolt capacity	CI 8.8 M7 ● 11 mm
Bolt capacity	CI 12.9 M6 ● 10 mm
Air inlet	1/4" GAS
Working pressure	6.2 bar
Internal hose size (Ø)	8 mm
Mean air consumption	96 l/min
Weight	0.6 kg

3/8	kg 0,6	€ 205,00	1	019210015
-----	--------	----------	---	-----------

1921N3

reversible air ratchet

• Knob speed regulator

1/2"

CE



Free speed	150 rpm
Max. torque	68 Nm
Bolt capacity	CI 8.8 M10 ● 16 mm
Bolt capacity	CI 12.9 M8 ● 13 mm
Air inlet	1/4" GAS
Working pressure	6.2 bar
Internal hose size (Ø)	10 mm
Mean air consumption	140 l/min
Weight	1.2 kg

1/2	kg 1,2	€ 205,00	1	019210025
-----	--------	----------	---	-----------

1922P1

reversible air impact ratchet

• "Double rocking dog" impulse device

1/4"

CE



Free speed	700 rpm
Maximum torque	68 Nm
Bolt capacity	CI 8.8 M10 ● 16 mm
Bolt capacity	CI 12.9 M8 ● 13 mm
Air inlet	1/4" GAS
Working pressure	6.2 bar
Internal hose size (Ø)	10 mm
Mean air consumption	88 l/min
Weight	0.6 kg

1/4	kg 0,6	€ 248,50	1	019220006
-----	--------	----------	---	-----------

1922P2

reversible air impact ratchet

• "Double rocking dog" impulse device

3/8"

CE



Free speed	700 rpm
Maximum torque	68 Nm
Bolt capacity	CI 8.8 M10 ● 16 mm
Bolt capacity	CI 12.9 M8 ● 13 mm
Air inlet	1/4" GAS
Working pressure	6.2 bar
Internal hose size (Ø)	10 mm
Mean air consumption	88 l/min
Weight	0.6 kg

3/8	kg 0,6	€ 248,50	1	019220010
-----	--------	----------	---	-----------

1922P3

reversible air impact ratchet

• "Double rocking dog" impulse device

1/2"

CE



Free speed	600 rpm
Maximum torque	136 Nm
Bolt capacity	CI 8.8 M12 ● 18 mm
Bolt capacity	CI 12.9 M10 ● 16 mm
Air inlet	1/4" GAS
Working pressure	6.2 bar
Internal hose size (Ø)	10 mm
Mean air consumption	113 l/min
Weight	1.5 kg

1/2	kg 1,5	€ 391,00	1	019220013
-----	--------	----------	---	-----------

1924F

butterfly compact reversible impact wrench

• "Double rocking dog" impulse device

3/8"

CE



Free speed	12,000 rpm
Maximum torque	108 Nm
Bolt capacity	CI 8.8 M12 ● 18 mm
Bolt capacity	CI 12.9 M10 ● 16 mm
Air inlet	1/4" GAS
Working pressure	6.2 bar
Internal hose size (Ø)	10 mm
Mean air consumption	59 l/min
Weight	0.5 kg

3/8	kg 0,5	€ 230,00	1	019240025
-----	--------	----------	---	-----------



1924B

compact reversible impact wrench

- "Pin Clutch" impulse device



Free speed	10,000 rpm
Max. torque	353 Nm
Bolt capacity	CI 8.8 M16●24 mm
Bolt capacity	CI 12.9 M14●21 mm
Air inlet	1/4" GAS
Working pressure	6,2 bar
Internal hose size (Ø)	8 mm
Mean air consumption	80 l/min
Weight	1,5 kg

3/8"	kg	€		
1,5		265,00	1	019240021

1927B

reversible impact wrench

- "Pin Clutch" impulse device



Free speed	7,000 rpm
Max. torque	705 Nm
Bolt capacity	CI 8.8 M22●34 mm
Bolt capacity	CI 12.9 M18●27 mm
Air inlet	1/4" GAS
Operating pressure	6,2 bar
Internal hose size (Ø)	10 mm
Mean air consumption	133 l/min
Weight	2,1 kg

1/2"	kg	€		
2,1		178,00	1	019270022

1927CD

reversible impact wrench,
made from composite material

- Double hammer impulse device



Free speed	7,000 rpm
Max. torque	1,020 Nm
Bolt capacity	CI 8.8 M22●34 mm
Bolt capacity	CI 12.9 M18●27 mm
Air inlet	1/4" GAS
Working pressure	6,2 bar
Internal hose size (Ø)	10 mm
Mean air consumption	130 l/min
Weight	1,9 kg

1/2"	kg	€		
2,3		369,00	1	019270007

1924CD

reversible impact wrench,
made from composite material

- Double hammer impulse device

NOT AVAILABLE IN THE USA



Free speed	10,000 rpm
Max. torque	410 Nm
Bolt capacity	CI 8.8 M16●24 mm
Bolt capacity	CI 12.9 M14●21 mm
Air inlet	1/4" GAS
Working pressure	6,2 bar
Internal hose size (Ø)	8 mm
Mean air consumption	79 l/min
Weight	1,3 kg

3/8"	kg	€		
1,3		320,00	1	019240007

1927B/K5

reversible impact wrench, made from
aluminium, supplied with 5 impact sockets, in
case



Free speed	7,000 rpm
Max. torque	705 Nm
Bolt capacity	CI 8.8 M22●34 mm
Bolt capacity	CI 12.9 M18●27 mm
Air inlet	1/4" GAS
Working pressure	6,2 bar
Internal hose size (Ø)	10 mm
Mean air consumption	133 l/min
Weight	2,1 kg

1/2"	kg	€		
3,5		236,50	1	019270122
350x305x86 mm				

1927CD/K3

assortment of one reversible impact wrench
and three impact sockets

- Double hammer impulse device



Free speed	7,000 rpm
Max. torque	1,020 Nm
Bolt capacity	CI 8.8 M22●34 mm
Bolt capacity	CI 12.9 M18●27 mm
Air inlet	1/4" GAS
Working pressure	6,2 bars
Internal hose size (Ø)	10 mm
Mean air consumption	130 l/min
Weight	1,9 kg

1/2"	kg	€		
4		414,00	1	019270107
350x305x86 mm				

1927P

reversible impact wrench, made from composite material
• Double hammer impulse device



Free speed	7,500 rpm
Max. torque	1.750 Nm
Bolt capacity	Cl 8.8 M24 ● 36 mm
Bolt capacity	Cl 12.9 M20 ● 30 mm
Air inlet	1/4" GAS
Operating pressure	6.2 bar
Internal hose size (Ø)	10 mm
Mean air consumption	290 l/min
Weight	2 kg

1/2"	kg	€	1	019270008
2,0		406,00		

1927P/K3

reversible impact wrench, made from composite material, supplied with 3 impact sockets



Free speed	7,500 rpm
Max. torque	1.750 Nm
Bolt capacity	Cl 8.8 M24 ● 36 mm
Bolt capacity	Cl 12.9 M20 ● 30 mm
Air inlet	1/4" GAS
Operating pressure	6.2 bar
Internal hose size (Ø)	10 mm
Mean air consumption	290 l/min
Weight	2.9 kg

1/2"	kg	€	1	019270118
4		472,00		
350x305x86 mm				

1927XM

compact reversible impact wrench
• Single hammer impulse device



Free speed	10,000 rpm
Max. torque	770 Nm
Bolt capacity	Cl 8.8 M22 ● 34 mm
Bolt capacity	Cl 12.9 M18 ● 27 mm
Air inlet	1/4" GAS
Operating pressure	6.2 bar
Internal hose size (Ø)	10 mm
Mean air consumption	122 l/min
Weight	1.3 kg

1/2"	kg	€	1	019270030
1,3		271,00		

1927XM/K5

Assortment of one compact reversible impact wrench and five impact sockets
• Single hammer impulse device



Free speed	10,000 rpm
Max. torque	770 Nm
Bolt capacity	Cl 8.8 M22 ● 34 mm
Bolt capacity	Cl 12.9 M18 ● 27 mm
Air inlet	1/4" GAS
Operating pressure	6.2 bar
Internal hose size (Ø)	10 mm
Mean air consumption	122 l/min
Weight	1.3 kg

1/2"	kg	€	1	019270129
2,8		332,00		
307x206x86 mm				

1927AN

Angle reversible impact wrench

• Single hammer impulse device



Max. torque	244 Nm
Bolt capacity	244 Nm
Bolt capacity	Cl 8.8 M14 ● 21 mm
Air inlet	Cl 12.9 M12 ● 19 mm
Operating pressure	1/4" GAS
Internal hose size (Ø)	6.2 bar
Mean air consumption	10 mm
Weight	2.1 kg

1/2"	kg	€	1	019270012
2,1		479,00		

1927G

compact reversible impact wrench

• Single hammer impulse device



Free speed	8500 rpm
Max. torque	325 Nm
Bolt capacity	Cl 8.8 M16 ● 24 mm
Bolt capacity	Cl 12.9 M14 ● 21 mm
Air inlet	1/4" GAS
Operating pressure	6.2 bar
Internal hose size (Ø)	10 mm
Mean air consumption	113 l/min
Weight	1.2 kg

1/2"	kg	€	1	019270050
1,2		394,00		

1927SP-AM

magnetic support for pneumatic impact wrench

- Fitted with two high-powered magnets with protective rubber tops
- Can accommodate 1 1/2" impact wrench, 4 sockets and 1 torque wrench
- Capacity: 10 kg



400	g	€	1	019270000
400		54,00		

1928XM

compact reversible impact wrench

- Double hammer impulse device
- Amazingly compact and powerful
- One-hand reverse button
- Three power adjustable screwing positions
- Exhaust through handle



Free speed	4,800 rpm
Max. torque	1,600 Nm
Bolt capacity	CI 8.8 M27●41 mm
Bolt capacity	CI 12.9 M24●36 mm
Air inlet	3/8" GAS
Operating pressure	6.2 bar
Internal hose size (Ø)	10 mm
Mean air consumption	175 l/min
Weight	2.9 kg

■	kg	€	1	019280030
3/4	2,9	538,00		

1928DA

reversible impact wrench

- Double hammer impulse device



Free speed	5,000 rpm
Max. torque	1,695 Nm
Bolt capacity	CI 8.8 M30●46 mm
Bolt capacity	CI 12.9 M27●41 mm
Air inlet	3/8" GAS
Working pressure	6.2 bar
Internal hose size (Ø)	10 mm
Mean air consumption	240 l/min
Weight	4.3 kg

■	kg	€	1	019280022
3/4	4,3	778,00		

1928K4

assortment of one reversible impact wrench and four impact sockets, long series

- "Pin Clutch" impulse device



Free speed	4,000 rpm
Max. torque	1,493 Nm
Bolt capacity	CI 8.8 M27●41 mm
Bolt capacity	CI 12.9 M24●36 mm
Air inlet	3/8" GAS BSP
Working pressure	6.2 bar
Internal hose size (Ø)	10 mm
Mean air consumption	260 l/min
Impact wrench weight	5.2 kg

■	kg	€	1	019280104
3/4	9,3	794,00		
410x330x106 mm				

1928CD

reversible impact wrench, made from composite material

- Double hammer impulse device



Free speed	4,500 rpm
Max. torque	1,800 Nm
Bolt capacity	CI 8.8 M27●41 mm
Bolt capacity	CI 12.9 M24●36 mm
Air inlet	3/8" GAS
Working pressure	6.2 bar
Internal hose size (Ø)	10 mm
Mean air consumption	215 l/min
Weight	3.5 kg

■	kg	€	1	019280007
3/4	3,5	886,00		

1928DAL

reversible impact wrench

- Double hammer impulse device



Free speed	5,000 rpm
Max. torque	1,695 Nm
Bolt capacity	CI 8.8 M27●41 mm
Bolt capacity	CI 12.9 M24●36 mm
Air inlet	3/8" GAS
Working pressure	6.2 bar
Internal hose size (Ø)	10 mm
Mean air consumption	240 l/min
Weight	4.8 kg

■	kg	€	1	019280023
3/4	4,8	834,00		

1930CD

reversible impact wrench, made from composite material

- Double hammer impulse device



Free speed	4,000 rpm
Max. torque	2,445 Nm
Bolt capacity	CI 8.8 M36●55 mm
Bolt capacity	CI 12.9 M30●46 mm
Air inlet	1/2" GAS
Working pressure	6.2 bar
Internal hose size (Ø)	13 mm
Mean air consumption	320 l/min
Weight	7.1 kg

■	kg	€	1	019300022
1	7,1	1.290,00		

1930LH

reversible impact wrench

- Double hammer impulse device

1"

CE



Free speed	6,000 rpm
Max. torque	2,441 Nm
Bolt capacity	CI 8.8 M36 ● 55 mm
Bolt capacity	CI 12.9 M30 ● 46 mm
Air inlet	1/2" GAS
Operating pressure	6.2 bar
Internal hose size (Ø)	13 mm
Mean air consumption	280 l/min
Weight	7.1 kg

■	kg	€	1	019300030
1	7,1	1.200,00		

1930LA

reversible impact wrench

- Double hammer impulse device

1"

CE



Free speed	4,000 rpm
Max. torque	2,445 Nm
Bolt capacity	CI 8.8 M36 ● 55 mm
Bolt capacity	CI 12.9 M30 ● 46 mm
Air inlet	1/2" GAS
Working pressure	6.2 bar
Internal hose size (Ø)	13 mm
Mean air consumption	460 l/min
Weight	10,6 kg

■	kg	€	1	019300037
1	10,6	1.225,00		

1930HLA

reversible impact wrench

- Double hammer impulse device

1"

CE



Free speed	3,000 rpm
Max. torque	3,661 Nm
Bolt capacity	CI 8.8 M42 ● 65 mm
Bolt capacity	CI 12.9 M33 ● 50 mm
Air inlet	1/2" GAS
Working pressure	6.2 bar
Internal hose size (Ø)	13 mm
Mean air consumption	460 l/min
Weight	16,4 kg

■	kg	€	1	019300040
1	16,4	1.690,00		

1930PA

reversible impact wrench

- Double hammer impulse device

1"

CE



Free speed	3,500 rpm
Max. torque	2,445 Nm
Bolt capacity	CI 8.8 M36 ● 55 mm
Bolt capacity	CI 12.9 M30 ● 46 mm
Air inlet	1/2" GAS
Operating pressure	6.2 bar
Internal hose size (Ø)	13 mm
Mean air consumption	350 l/min
Weight	9.6 kg

■	kg	€	1	019300032
1	9,6	1.164,00		

1930A

reversible impact wrench

- Double hammer impulse device

1"

CE



Free speed	4,000 rpm
Max. torque	2,445 Nm
Bolt capacity	CI 8.8 M36 ● 55 mm
Bolt capacity	CI 12.9 M30 ● 46 mm
Air inlet	1/2" GAS
Working pressure	6.2 bar
Internal hose size (Ø)	13 mm
Mean air consumption	460 l/min
Weight	9.5 kg

■	kg	€	1	019300036
1	9,5	1.175,00		

1930ZL

reversible impact wrench

- Double hammer impulse device

1 1/2"

CE



Free speed	3,000 rpm
Max. torque	4,068 Nm
Bolt capacity	CI 8.8 M42 ● 65 mm
Bolt capacity	CI 12.9 M36 ● 55 mm
Air inlet	1/2" GAS
Working pressure	6.2 bar
Internal hose size (Ø)	13 mm
Mean air consumption	480 l/min
Weight	15 kg

■	kg	€	1	019300070
1 1/2	15	2.130,00		

1931CD6

reversible drill,
made from composite material



Free speed	2,600 rpm
Chuck capacity	1÷6 mm
Power	0,23 kW
Spindle thread	3/8" - 24UNF
Air inlet	1/4" GAS
Working pressure	6,2 bar
Internal hose size (Ø)	8 mm
Mean air consumption	130 l/min
Weight	0,6 kg

kg 0,6 € 244,50 1 019310006

1931CD13

reversible drill,
made from composite material



Free speed	800 rpm
Chuck capacity	1,0÷13 mm
Power	0,38 kW
Spindle thread	1/2" - 20UNC
Air inlet	1/4" GAS
Working pressure	6,2 bar
Internal hose size (Ø)	10 mm
Mean air consumption	170 l/min
Weight	1,3 kg

kg 1,3 € 328,00 1 019310013

1932B10

reversible drill



Free speed	1,800 rpm
Chuck capacity	1÷10 mm
Power	0,44 kW
Spindle thread	3/8" - 24UNF
Air inlet	1/4" GAS
Working pressure	6,2 bar
Internal hose size (Ø)	10 mm
Mean air consumption	160 l/min
Weight	1,2 kg

kg 1,2 € 175,00 1 019320040

1931CD10

reversible drill,
made from composite material



Free speed	1,800 rpm
Chuck capacity	1÷10 mm
Power	0,38 kW
Spindle thread	3/8" - 24UNF
Air inlet	1/4" GAS
Working pressure	6,2 bar
Internal hose size (Ø)	10 mm
Mean air consumption	170 l/min
Weight	1 kg

kg 1,0 € 220,50 1 019310010

1931AN10

reversible angle drill



Free speed	1,400 rpm
Chuck capacity	1÷10 mm
Power	0,38 kW
Spindle thread	3/8" - 24UNF
Air inlet	1/4" GAS
Working pressure	6,2 bar
Internal hose size (Ø)	10 mm
Mean air consumption	150 l/min
Weight	1,1 kg

kg 1,1 € 244,50 1 019310030

1932RS13

reversible drill



Free speed	750 rpm
Chuck capacity	1,5÷13 mm
Power	0,55 kW
Spindle thread	3/8" - 24UNF
Air inlet	1/4" GAS
Working pressure	6,2 bar
Internal hose size (Ø)	10 mm
Mean air consumption	160 l/min
Weight	1,4 kg

kg 1,4 € 222,50 1 019320043

1932B13

reversible drill



Ø 1/4" GAS BSPT

Free speed	400 rpm
Chuck capacity	1,5÷13 mm
Power	0,34 kW
Spindle thread	1/2" - 20UNC
Air inlet	1/4" GAS
Operating pressure	6,2 bar
Internal hose size (Ø)	10 mm
Mean air consumption	180 l/min
Weight	1,6 kg

kg	€	1	019320004
1,6	262,00		

1933IH

high-power die grinder

- Collect chuck, Ø 3 mm and 6 mm



Free speed	20,000 rpm
Chuck capacity	3 - 6 mm
Power	0,75 kW
Air inlet	1/4" GAS
Working pressure	6,2 bar
Internal hose size (Ø)	10 mm
Mean air consumption	370 l/min
Weight	800 g

g	€	1	019330006
800	198,00		

1933ILH

high-power long spindle die grinder

- Collect chuck, Ø 3 mm and 6 mm



Free speed	20,000 rpm
Chuck capacity	3 - 6 mm
Power	0,75 kW
Air inlet	1/4" GAS
Working pressure	6,2 bar
Internal hose size (Ø)	10 mm
Mean air consumption	370 l/min
Weight	1,2 kg

kg	€	1	019330011
1,2	373,00		

1933AN90-H

high-power angle grinder

- Collect chuck, Ø 3 mm and 6 mm



Free speed	15,000 rpm
Chuck capacity	3 - 6 mm
Power	0,75 kW
Air inlet	1/4" GAS
Working pressure	6,2 bar
Internal hose size (Ø)	10 mm
Mean air consumption	370 l/min
Weight	1,1 kg

kg	€	1	019330021
1,1	373,00		

1933

die grinder

- Collect chuck, Ø 3 mm and 6 mm



Free speed	25,000 rpm
Chuck capacity	3 - 6 mm
Power	0,20 kW
Air inlet	1/4" GAS
Working pressure	6,2 bar
Internal hose size (Ø)	10 mm
Mean air consumption	230 l/min
Weight	380 g

g	€	1	019330001
380	130,50		

1933I

die grinder

- Collect chuck, Ø 3 mm and 6 mm



Free speed	20,000 rpm
Chuck capacity	3 - 6 mm
Power	0,38 kW
Air inlet	1/4" GAS
Working pressure	6,2 bar
Internal hose size (Ø)	10 mm
Mean air consumption	260 l/min
Weight	670 g

g	€	1	019330005
670	148,00		

1933L

long spindle die grinder

- Collect chuck, Ø 3 mm and 6 mm



Free speed	25,000 rpm
Chuck capacity	3 - 6 mm
Power	0,20 kW
Air inlet	1/4" GAS
Working pressure	6,2 bar
Internal hose size (Ø)	10 mm
Mean air consumption	270 l/min
Weight	670 g

g	€	1	019330015
670	166,00		

1933IL

long spindle die grinder

- Collect chuck, Ø 3 mm and 6 mm



Free speed	20,000 rpm
Chuck capacity	3 - 6 mm
Power	0,38 kW
Air inlet	1/4" GAS
Working pressure	6,2 bar
Internal hose size (Ø)	10 mm
Mean air consumption	113 l/min
Weight	1,4 kg

kg	€	1	019330010
1,4	202,00		

1933AN90

angle grinder

- Collect chuck, Ø 3 mm and 6 mm



Free speed	20,000 rpm
Chuck capacity	3 - 6 mm
Power	0,20 kW
Air inlet	1/4" GAS
Working pressure	6,2 bar
Internal hose size (Ø)	10 mm
Mean air consumption	230 l/min
Weight	510 g

g 510 € 166,00 1 019330020

1934BV

low-speed tyre buffer

- Collect chuck, Ø 3 mm and 6 mm



Free speed	3,700 rpm
Chuck capacity	3 - 6 mm
Power	0,37 kW
Air inlet	1/4" GAS
Operating pressure	6,2 bar
Internal hose size (Ø)	10 mm
Mean air consumption	113 l/min
Weight	0.84 kg

g 840 € 180,00 1 019340000

1934MAV

micro die grinder



Free speed	56,000 rpm
Chuck capacity	3 mm
Power	0,04 kW
Air inlet	1/4" GAS BSPT
Operating pressure	6,2 bar
Internal hose size (Ø)	4,5 mm
Mean air consumption	115 l/min
Weight	0.2 kg

g 205 € 154,50 1 019340010

1934MAV70

high-speed micro die grinder



Free speed	70,000 rpm
Chuck capacity	3 mm
Power	0,08 kW
Air inlet	1/4" GAS BSPT
Operating pressure	6,2 bar
Internal hose size (Ø)	4,5 mm
Mean air consumption	115 l/min
Weight	0.21 kg

g 210 € 256,00 1 019340030

1935F

reversible air screwdriver



Free speed	800 rpm
Torque range	4-16 Nm
Screw capacity	6-9 M
Bit holder	● 1/4"
Air inlet	1/4" GAS
Working pressure	6,2 bar
Internal hose size (Ø)	10 mm
Mean air consumption	150 l/min
Weight	1,3 kg

kg 1,3 € 244,50 1 019350045

1936/4A

angle grinder



Free speed	11,000 rpm
Grinding disc size	115 mm
Power	0,66 kW
Spindle thread	M14
Air inlet	1/4" GAS
Operating pressure	6,2 bar
Internal hose size (Ø)	10 mm
Mean air consumption	390 l/min
Weight	1,77 kg

kg 1,8 € 403,00 1 019360024



1936/5A

angle grinder

CE



Free speed	10,000 rpm
Grinding disc size	125 mm
Power	0,66 kW
Spindle thread	M14
Air inlet	1/4" GAS
Working pressure	6,2 bar
Ø internal hose size	10 mm
Mean air consumption	390 l/min
Weight	1,9 kg

kg	€		
1,9	403,00	1	019360025

1936/7A

angle grinder



Free speed	7600 giri/min
Grinding disc size	180 mm
Power	1,3 kW
Spindle thread	M14
Air inlet	3/8" GAS
Working pressure	6,2 bar
Ø internal hose size	13 mm
Mean air consumption	906 l/min
Weight	2,7 kg

kg	€		
2,7	590,00	1	019360027

1937,2,5

roto-orbital palm sander
lubrication free, made from composite material

- Orbit diameter: 2.5 mm

CE



Free speed	12,000 rpm
Power	0.18 kW
Pad size	150 mm
Orbit diameter	2.5 mm
Spindle thread	5/16"-24
Air inlet	1/4" GAS
Operating pressure	6.2 bar
Internal hose size (Ø)	10 mm
Mean air consumption	170 l/min
Weight	0.86 kg

kg	€		
0,86	426,00	1	019370000

1937

roto-orbital palm sander, lubrication free, made from composite material

- Orbit diameter: 5 mm

CE



Free speed	12,000 rpm
Power	0.18 kW
Pad size	150 mm
Orbit diameter	5 mm
Spindle thread	5/16"-24
Air inlet	1/4" GAS
Operating pressure	6.2 bar
Internal hose size (Ø)	10 mm
Mean air consumption	170 l/min
Weight	0,86 kg

kg	€		
0,86	426,00	1	019370001

1937R/P

6-hole pad, Ø 150 mm,
for item 1937



1937R/P	€		
	44,50	1	019370002

1937KC

mini orbital sander

- Orbit diameter 4 mm
- 2 sanding pads (Ø 50 mm and Ø 75 mm)
- 10 abrasive paper discs (Ø 50 mm), grain 400, 600, 800
- 10 abrasive paper discs (Ø 75 mm), grain 400, 600, 800

CE



Free speed	15000
Power	0.25
Pad size	50 - 75
Spindle thread	M6 x 1.0
Air inlet	1/4" GAS BSPT
Operating pressure	6.2 bar
Internal hose size (Ø)	10
Mean air consumption	79
Polisher weight	0.64
Kit weight	1.4

kg	€		
1,4	243,50	1	019370171

1937C...

abrasive paper discs for item 1937KC



Ø mm	P	€		
50	400	14,50	1	019370175
50	600	14,50	1	019370176
50	800	14,50	1	019370177
75	400	18,40	1	019370178
75	600	18,40	1	019370179
75	800	18,40	1	019370180

* Prices refer to 10 pieces

1937KL

mini polisher

- Sanding pad (Ø 75 mm) - 1937/KL-DSB, 1937/KL-DSG
- 2 polishing sponges (Ø 90 mm) - 1937/KL-DLB, 1937/KL-DLA

CE



Free speed	3,200 rpm
Power	0.25 kW
Pad size	75 mm
Spindle thread	M6
Air inlet	1/4" GAS BSPT
Operating pressure	6.2 bar
Internal hose size (Ø)	10 mm
Mean air consumption	91 l/min
Polisher weight	0.75 kg
Kit weight	1.8 kg

kg	€		
1,8	266,00	1	019370161

Beta

1937KL-D

accessories for item 1937KL



	Ø mm	€		
1937KL-DLA	90	23,90	1	019370164
1937KL-DSB	90	23,90	1	019370165
1937KL-DSG	90	23,90	1	019370166

1937K...

Pads for items 1937KC and 1937KL



	Ø mm	1937KC	1937KL	€		
1937KC-RP	50	•		26,00	1	019370173
1937KL-RP	75	•	•	31,50	1	019370163

1937M

multi-use sander
with 16 accessories



Free speed	3,500 rpm
Power	0,34 kW
Air inlet	1/4" GAS
Working pressure	6,2 bar
Internal hose size (Ø)	10 mm
Mean air consumption	113 l/min
Sander weight	1,5 kg
Kit weight	4,5 kg

kg	€		
4,5	728,00	1	019370011
458x495x116 mm			

1937M-01÷11

accessories for item 1937M



	L mm	1937M-	€		
1937M-01	30		27,50	1	019370101
1937M-02	30		27,50	1	019370102
1937M-03	11		23,90	1	019370103
1937M-04	23		23,90	1	019370104
1937M-05	11		23,90	1	019370105
1937M-06	23		23,90	1	019370106
* 1937M-07	16		65,50	1	019370107
1937M-08	13	07	23,90	1	019370108
1937M-09	26	07	23,90	1	019370109
1937M-10	11	03, 05	23,90	1	019370110
1937M-11	23	01, 02, 04, 06	23,90	1	019370111

* The prices shown are for 6 pieces

1937N10

pneumatic belt sander



Free speed	20,000 rpm
Power	0,37 kW
Belt size	10x330 mm
Air inlet	1/4" GAS
Working pressure	6,2 bar
Internal hose size (Ø)	10 mm
Mean air consumption	374 l/min
Weight	0,9 kg

kg	€		
0,9	286,00	1	019370041

1937N10-GR

sand belts for item 1937N10



	P	€		
1937N10-GR60	60	30,00	1	019370146
1937N10-GR80	80	30,00	1	019370148
1937N10-GR100	100	30,00	1	019370150
1937N10-GR120	120	30,00	1	019370152

The prices shown are for 10 pieces

1937N20

pneumatic belt sander



Free speed	16,000 rpm
Power	0,45 kW
Belt size	20x520 mm
Air inlet	1/4" GAS
Working pressure	6,2 bar
Internal hose size (Ø)	10 mm
Mean air consumption	400 l/min
Weight	1,6 kg

kg	€		
1,6	332,00	1	019370051

1937N20-GR

sand belts for item 1937N20



	P	€		
1937N20-GR60	60	39,00	1	019370156
1937N20-GR80	80	39,00	1	019370158
1937N20-GR100	100	39,00	1	019370160
1937N20-GR120	120	39,00	1	019370162

The prices shown are for 10 pieces

1938

windscreen remover

• Supplied with 1 57 mm straight blade



Oscillations/minute	20,000
Air inlet	1/4" GAS
Operating pressure	6,2 bar
Internal hose size (Ø)	6,5 mm
Mean air consumption	200 l/min
Weight	1,0 kg

kg	€		
1,0	224,50	1	019380021



1938R/L

blades for windscreen removers



	L mm	€	📦	🚚
1938R/L1	57	18,90	1	019380041
1938R/L2	90	35,00	1	019380042
1938R/L3	30	21,10	1	019380043
1938R/L4	8	30,00	1	019380044
1938R/L5	36	34,50	1	019380045

1938R/S5

set of 5 blades for item 1938

	€	📦	🚚
1938R/S5	139,50	1	019380055



1940

air hammer

• Supplied with a nonreturn spring and a bayonet retainer for hexagon chisels



Strokes per minutes	3,500
Chisel inlet	□ 11 mm
Piston size	19 mm
Piston stroke	67 mm
Air inlet	1/4" GAS
Working pressure	6.2 bar
Internal hose size (Ø)	8 mm
Mean air consumption	240 l/min
Weight	1.9 kg

kg	€	📦	🚚
1,9	180,00	1	019400001

1940/C6

air hammer with 5 chisels and accessories

- For cutting sheet metal, bolts and bodies, removing welding slags, rivets, plaster and tiles
- Assortment in a convenient ABS tool case, comprised of:
 - 1 air hammer item 1940
 - 1 flat chisel item 1940SN
 - 1 demolition chisel item 1940ST
 - 1 round-tipped chisel item 1940SD
 - 1 bevel chisel item 1940SPS
 - 1 sheet metal cutting chisel 1940SDT
 - 1 nonreturn spring item 1940MT
 - 1 bayonet retainer for hexagon chisels



Strokes per minute	3,500
Chisel inlet	□ 11 mm
Piston size	19 mm
Piston stroke	67 mm
Air inlet	1/4" GAS
Working pressure	6.2 bar
Internal hose size (Ø)	8 mm
Mean air consumption	240 l/min
Weight	3.3 kg

kg	€	📦	🚚
3,3	255,00	1	019400000

320x240x90 mm

1940MT

spare retainer spring for item 1940



	€	📦	🚚
1940MT	11,70	5	019400110

1940S...

chisels for air hammers
item 1940



	€	📦	🚚
1940SN	14,50	5	019400020
1940ST	14,50	5	019400021
1940SD	14,50	5	019400022
1940SPS	14,50	5	019400023
1940SDT	14,50	5	019400024

1940/S5

set of 5 chisels for air hammers
item 1940



	€	📦	🚚
1940/S5	66,00	1	019400030

1940E10

air hammer

- Compatible with chisels with 10-mm hexagon drive
- Supplied with a nonreturn spring and a bayonet retainer



Strokes per minute	2,900
Inlet size	□ 10 mm
Piston size	19 mm
Piston stroke	67 mm
Chisel inlet	1/4" GAS
Working pressure	6.2 bar
Internal hose size (Ø)	10 mm
Mean air consumption	76 l/min
Weight	1.7 kg

kg	€	📦	🚚
1,7	198,00	1	019400010

1940E10/MT

spare retainer spring for item 1940E10



	€	📦	🚚
1940E10/MT	1,55	5	019400112

1940E10/S...

chisels for air hammers 1940E10



	€	📦	🚚
1940E10/SN	10,00	5	019400040
1940E10/ST	10,00	5	019400041
1940E10/SD	10,00	5	019400042
1940E10/SPS	10,00	5	019400043
1940E10/SDT	10,00	5	019400044

1940E10/S5

set of 5 chisels
for air hammers 1940E10



1940E10/S5 € 50,00 1 019400050

1942A

air saw



Strokes per minute 10.000
Stroke length 10 mm
Air inlet 1/4" GAS BSP
Operating pressure 6,2 bar
Internal hose size (Ø) 8 mm
Mean air consumption 75 l/min
Weight 550 g

g 550 € 299,00 1 019420000

1942LR

Bimetal blades
for air saw 1942A



1942LR € 6,90 5 019420032

1944A

axial needle scaler

CE



Strokes per minute 3.800
Stroke length 33 mm
N°. of needles 19
Needle size (Ø) 3 mm
Air inlet 1/4" GAS
Working pressure 6,2 bar
Internal hose size (Ø) 10 mm
Mean air consumption 85 l/min
Weight 2,8 kg

kg 2,8 € 337,00 1 019440011

1944N

needle scaler



Strokes per minute 3800
Stroke length 33 mm
N°. of needles 19
Needle size (Ø) 3 mm
Air inlet 1/4" GAS
Working pressure 6,2 bar
Internal hose size (Ø) 8 mm
Mean air consumption 85 l/min
Weight 2,7 kg

kg 2,7 € 431,00 1 019440002

1944AR

set of needles
for needle scalars 1944N and 1944A



	Ø mm	n.	€		
1944AR 2	2	29	44,50	1	019440015
1944AR 3	3	19	34,50	1	019440005

1944PA

needle plates for items 1944N and 1944A



	Ø mm	N.	€		
1944PA 2	2	29	48,50	1	019440016
1944PA 3	3	19	36,50	1	019440006

1945S

stapler

• Uses staples type 80, section 0.95 x 0.65 mm (21-Gauge), length: 4 - 16 mm; width: 12.8 mm



Magazine capacity 157 pcs
Air inlet 1/4" GAS
Working pressure 4,2 - 7 bar
Internal hose size (Ø) 8 mm
Air consumption (7 bar) 0,34 l/cycle
Weight 0,87 kg

kg 0,9 € 183,50 1 019450000

1945S/G...

staples type 80, section 0.95x0.65 mm (21-Gauge), width 12.8 mm, for item 1945S



	L mm	€		
• 1945S/G4	4	16,90	1	019450004
1945S/G6	6	6,70	1	019450006
1945S/G8	8	7,25	1	019450008
1945S/G10	10	8,10	1	019450010
1945S/G12	12	9,05	1	019450012
1945S/G14	14	9,85	1	019450014
1945S/G16	16	10,80	1	019450016

Stated prices are for 5,000 pieces
• Stated prices are for 10,000 pieces

1945C

stapler, nailer, combo tool

• Uses staples type 90, section 1.25 x 1.0 mm (18-Gauge), length: 16 - 40 mm; width: 5.8 mm
• Uses round-headed nails type B12, section 1.25 x 1.0 mm (18-Gauge), 1,9-mm head



Magazine capacity 100 pcs
Air inlet 1/4" GAS
Working pressure 5 - 8 bar
Internal hose size (Ø) 8 mm
Air consumption (7 bar) 1,12 l/cycle
Weight 1,16 kg

kg 1,16 € 241,50 1 019450200

1945C/G...

staples type 90, section 1.25x1.0 mm (18-Gauge), width 5.8 mm, for item 1945C

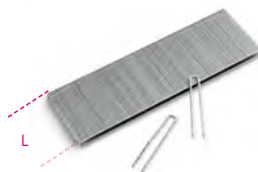

	L mm	€		
1945C/G16	16	12,90	1	019450216
1945C/G19	19	15,30	1	019450219
1945C/G22	22	16,80	1	019450222
1945C/G25	25	19,80	1	019450225
1945C/G28	28	20,80	1	019450228
1945C/G32	32	24,20	1	019450232
1945C/G35	35	26,00	1	019450235
1945C/G38	38	29,00	1	019450238
1945C/G40	40	31,00	1	019450240

Stated prices are for 5,000 pieces

1945C/GP...

nails type B12, section 1.25x1.0 mm
(18-Gauge), 1.9 mm-head, for item 1945C

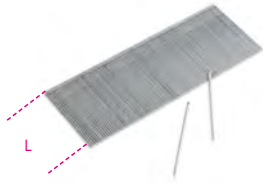

	L mm	€	📦	🏠
1945C/GP15	15	6,80	1	019450255
1945C/GP16	16	7,05	1	019450256
1945C/GP20	20	8,10	1	019450260
1945C/GP25	25	9,55	1	019450265
1945C/GP30	30	11,10	1	019450270
1945C/GP32	32	12,20	1	019450272
1945C/GP35	35	13,10	1	019450275
1945C/GP38	38	14,20	1	019450278
1945C/GP40	40	14,70	1	019450280
1945C/GP45	45	16,20	1	019450285
1945C/GP50	50	17,80	1	019450290

Stated prices are for 5,000 pieces

1945P

headless pinner

• Uses pins type B6, Ø 0.64 mm (23-Gauge),
length: 12 - 35 mm



Magazine capacity	145 pcs
Air inlet	1/4" GAS
Working pressure	4 - 7 bar
Internal hose size (Ø)	8 mm
Air consumption (7 bar)	0.27 l/cycle
Weight	0.87 kg

📦	€	📦	🏠
0,87	293,00	1	019450100

1945P/S...

pins type B6, Ø 0.64 mm (23-Gauge), for item 1945P



	L mm	€	📦	🏠
1945P/S12	12	7,90	1	019450112
1945P/S15	15	8,65	1	019450115
1945P/S18	18	9,45	1	019450118
1945P/S20	20	10,90	1	019450120
1945P/S21	21	11,10	1	019450121
1945P/S22	22	11,40	1	019450122
1945P/S25	25	12,20	1	019450125
1945P/S30	30	14,00	1	019450130
1945P/S35	35	15,90	1	019450135

Stated prices are for 10,000 pieces

1946T

air riveter

• supplied with interchangeable nozzles for steel, stainless steel, aluminium and copper rivets, 2.4 - 3.2 - 4.0 - 4.8 mm long



Traction power	9,000 N
Stroke length	16 mm
Maximum rivet capacity	Stainless steel Ø 4.8 mm
Air inlet	1/4" GAS
Working pressure	6,2 bar
Internal hose size (Ø)	8 mm
Air consumption	2.0 l/cycle
Weight	1.7 kg

📦	€	📦	🏠
1,7	264,00	1	019460021

1946C4,8

riveter

• Automatic suction
• Supplied assembled for use with 2.4 - 3.2 - 4.0 - 4.8 mm long steel, stainless steel, aluminium and copper rivets



Traction power	8,900 N
Stroke length	15 mm
Maximum rivet capacity	Stainless steel Ø 4.8 mm
Air inlet	1/4" GAS
Operating pressure	6,2 bar
Internal hose size (Ø)	10 mm
Air consumption	2.6 l/cycle
Weight	1.5 kg

📦	€	📦	🏠
1,5	570,00	1	019460006

1946C7,8

riveter

• Automatic suction
• Supplied assembled for use with 4.8 - 5.6 - 6.4 - 7.8 mm long steel, stainless steel, aluminium and copper rivets



Traction power	16,900 N
Stroke length	22.5 mm
Maximum rivet capacity	Stainless steel Ø 7.8 mm
Air inlet	1/4" GAS
Operating pressure	6,2 bar
Internal hose size (Ø)	10 mm
Air consumption	4.9 l/cycle
Weight	1.8 kg

📦	€	📦	🏠
1,8	896,00	1	019460008

1946C/T...

heads for structural rivets



	Ø mm	€	📦	🏠
1946C/T4,8	4,8	34,50	1	019460016
1946C/T6,4	6,4	34,50	1	019460018

1946KF

air riveter for threaded inserts

• Supplied assembled for threaded rivets made of steel, stainless steel, aluminium and copper, M4, M5, M6, M8



Traction power	14,235 N
Stroke length	7 mm
Maximum rivet capacity	Stainless steel Ø, M8
Air inlet	1/4" GAS
Operating pressure	6,2 bar
Internal hose size (Ø)	10 mm
Air consumption	2.1 l/cycle
Air riveter weight	2.1 kg
Kit weight	3.4 kg

📦	€	📦	🏠
3,4	1.890,00	1	019460012



1946KF/M...

spare pins for item 1946KF



	€	kg	1	019460124
1946KF/M4	60,50		1	019460124
1946KF/M5	60,50		1	019460125
1946KF/M6	60,50		1	019460126
1946KF/M8	60,50		1	019460128

1947

bonding gun

- Pneumatic gun for medium-density silicone, adhesives and bonds
- Supports standard cartridges (210 x 50 mm), hard and soft

CE



Tube size	210x50 mm
Cartridge capacity	350 ml
Air inlet	1/4" GAS
Working pressure	4.8 bar
Internal hose size (Ø)	10 mm
Mean air consumption	120 l/min
Weight	1,1 kg

kg	€	1	019470001
1,1	64,00	1	019470001

1947H

bonding gun

- Pneumatic gun for extruding silicone and bonds in standard plastic or aluminium
- Supports standard cartridges (215/218 x 50/51 mm), hard and soft
- Built-in pressure reducing valve

CE



Tube size	210x50 mm
Cartridge capacity	300/310 ml
Air inlet	1/4" GAS
Working pressure	4 ÷ 8 bar
Internal hose size (Ø)	2.5 mm
Mean air consumption	120 l/min
Weight	750 g

g	€	1	019470011
750	222,50	1	019470011

1947G

grease gun

Die-cast aluminium head
Ergonomic grip for ease of access to tough greasing points
Corrosion-resistant brass valve
Takes 400 g cartridges or bulk grease up to 500 cc
Tube size: 54 (interior) x 260 mm
Air inlet: 1/4" GAS
Operating pressure: 4÷10 bar
Weight: 1.9 kg



Tube size: 54 (interior) x 260 mm
Air inlet: 1/4" GAS
Operating pressure: 4÷10 bar
Weight: 1.9 kg

	€	kg	1	019470051
1947G	157,00		1	019470051

1947G2

2-in-1 grease gun

For continuous or non-continuous grease supply
Die-cast aluminium head
Ergonomic handle
Takes 400 cc cartridges or bulk grease up to 500 cc



Hose size 54 (interior) x 276 mm
Air inlet 1/4" GAS BSP
Operating pressure 3÷10 bar
Weight 2,2 kg

	€	kg	1	019470060
1947G2	161,50		1	019470060



1947M

gun for single-component sealants

- Can be used with 310 ml plastic cartridges
- Supplied with extrusion nozzle kit



Tube dimensions 210x50 mm
Cartridge capacity 310 ml
Air inlet 1/4" GAS
Working pressure 3 ÷ 5 bar
Nozzle Ø 1.6 - 2.5 mm
Mean air consumption 250 l/min
Weight 1.2 kg

kg	€	1	019470021
1,2	310,00	1	019470021

1947M -...

spare nozzles for item 1947M



	€	kg	10	019470025
1947M-ST	3,00		10	019470025
1947M-T	1,67		10	019470026
1947M-P	2,44		10	019470027

1948

engraving pen

- Allows such materials as steel, stainless steel, aluminium, glass, stone and ceramic to be marked

CE



Strokes per minute 3,500 ÷ 3,800
Maximum hardness 60 HRC
Air inlet 1/4" GAS
Working pressure 6.2 bar
Mean air consumption 50 l/min
Weight 150 g

g	€	1	019480001
150	294,00	1	019480001

1948PR

spare tungsten carbide bit
for item 1948

- Maximum hardness: 60 HRC



1948PR € 110,50 1 019480005

1949U5

progressive blow gun with 5 nozzles

- Hard-wearing, shockproof composite material body
- 3 steel nozzles, 100/160/320 mm, scratchproof, protective rubber tips
- 1 "Turbo" nozzle made of fibreglass-reinforced nylon with safety tip
- 1 revolving nozzle, 100 mm, made of fibreglass-reinforced nylon
- With quick fixing system



Ø 1/4" GAS BSPT

Threaded brass insert	1/4" GAS
Working pressure	10 bar
Maximum working pressure	15 bar
Mean air consumption	280 l/min
Working temperature	-10°C ÷ 80°C
Weight	93 g

g 93 € 35,00 1 019490030

1949U5/A

steel nozzle, 100 mm, with scratchproof,
protective rubber tip, for item 1949U5 - 1949P



1949U5/A € 7,05 1 019490131

1949U5/B

steel nozzle, 160 mm, with scratchproof,
protective rubber tip, for item 1949U5 - 1949P



1949U5/B € 7,15 1 019490132

1949U5/C

steel nozzle, 320 mm, with scratchproof,
protective rubber tip, for item 1949U5 - 1949P



1949U5/C € 9,15 1 019490133

1949U5/D

revolving nozzle, 100 mm, made of fibreglass
reinforced nylon, for item 1949U5 - 1949P



1949U5/D € 6,70 1 019490134

1949U5/E

"Turbo" nozzle made of fibreglass-reinforced
nylon, with safety tip



1949U5/E € 3,35 1 019490135

1949U5/F

flat, fan-shaped nozzle, made of fibreglass-
reinforced nylon, for items 1949U5 and 1949P



1949U5/F € 4,25 1 019490136

1949U5/G

OSHA nozzle, made of fibreglass-reinforced
nylon, for items 1949U5 and 1949P



1949U5/G € 3,20 1 019490137



1949BC

progressive blow gun with rubber nozzle

- Hard-wearing, shockproof composite material body
- Replaceable scratchproof rubber nozzle



Aluminium threaded insert	1/4" GAS
Operating pressure	6-8 bar
Maximum operating pressure	15 bar
Mean air consumption	87 l/min
Operating temperature	-20°C ÷ 70°C
Weight	120 g

g 120 € 17,00 1 019490022

1949BC/RU

5 rubber nozzles for item 1949BC



1949BC/RU € 21,10 1 019490122

1949P

progressive mini blow gun

- Hard-wearing, shockproof composite material body
- Quick nozzle fixing system
- Airflow can be adjusted through ring nut rotation



Brass threaded insert	1/4" GAS
Working pressure	6-8 bar
Maximum operating pressure	15 bar
Mean air consumption	280 l/min
Operating temperature	-10°C ÷ 85°C
Weight	70 g

g 70 € 22,30 1 019490031

1949T

telescopic progressive blow gun

- Hard-wearing, shockproof composite material body
- Telescopic steel swivel tube: 165 mm ± 300 mm



Aluminium threaded insert
Operating pressure 6÷8 bar
Maximum operating pressure 15 bar
Mean air consumption 144 l/min
Operating temperature -20°C ÷ 70°C
Weight 190 g

190 g 27,50 € 1 019490040

1949F

progressive blow gun

- Made from hard-wearing, shockproof, scratchproof, thermally insulated composite plastic material
- The special valve and the lever allow the circuit to be progressively opened, thus optimizing air flow



Brass threaded insert
Operating pressure 6-8 bar
Maximum operating pressure 10 bar
Operating temperature -15°C ÷ 70°C
Weight 130 g

130 g 15,80 € 5 019490027

Beta

1949G

progressive blow gun
with air regulator

- Made from hard-wearing, shockproof, scratchproof, thermally insulated composite plastic material
- The special valve and the lever allow the circuit to be progressively opened, thus optimizing air flow



Brass threaded insert
Operating pressure 6-8 bar
Maximum operating pressure 10 bar
Operating temperature -15 °C ÷ 70 °C
Weight 140 g

140 g 16,20 € 5 019490035

1949GPA

tyre inflator

- shockproof rubber coated body
- metal operating lever
- operating pressure: 0,5÷12 bar, 7÷174 psi
- pressure release feature
- pressure measurement feature
- pipe length: 58 cm
- 360° hose rotation
- 1/4" air inlet



1949GPA 0,5÷12 7÷174 101,00 € 1 019490018

1949DGT/2

digital tyre inflator

- shockproof rubber coated body
- metal operating lever
- operating pressure: 0.5÷12 bar, 7÷174 psi
- 4 units of measurement, bar/psi/kpa/kgf
- backlit LCD display
- resolution: 0.05 bar
- self-power off after 1.5 minutes
- hose length: 58 cm
- 360° hose rotation
- power supply: 2 AAA batteries
- 1/4" air inlet



1949DGT/2 0,5÷12 7÷174 121,50 € 1 019490021

1949GPN

tyre inflator,
ABS housing

- CE certified pressure gauge with scale 0.7÷12 bars (graduation: 1/10 bars)
- Two servo-controlled buttons allow accurate, quick tyre inflating (+) and deflating (-)
- Supplied with a calibration certificate
- Fitted with a shockproof, protective shell and an eyelet
- Fitted with a 1/4" GAS threaded coupler
- Swivel air inlet for rubber hose, Ø 7 mm



1949GPN 0,7÷12 810 226,00 € 1 019490011

1949M

tyre pressure tester



1949M 0÷4 5÷60 280 71,00 € 1 019490400

Beta

1949R

blow gun
for cleaning radiators
the 5 holes that are perpendicular to the handle
allow dirt to be removed from radiators



L mm	$\frac{1}{4}$ " mm	€	🔧	📄
600	6	64,50	1	019490050

1951

cleaning gun
• For cleaning car upholstery, carpeting, seats and boots



Free speed	
Tank capacity	1 L
Air inlet	1/4" GAS
Working pressure	6,2 bar
Internal hose size (Ø)	8 mm
Mean air consumption	110 l/min
Weight	650 g

🔧	€	📄
650	138,00	1 019510051

1951A

suction cleaning gun
• For cleaning car upholstery, carpeting, seats and boots
• For use with suitable detergents
• 1L tank
• Fitted with a tap for dispensing liquid from tank
• Complete with corrugated tube, 1.8 m long



Tank capacity	1 l
Air inlet	1/4" GAS
Operating pressure	6.2 bar
Internal hose size (Ø)	8 mm
Mean air consumption	120 l/min
Weight	800 g

🔧	€	📄
800	224,50	1 019510101

1952

professional paint spray gun
• Die-cast aluminium body plated with black chemical nickel
• Nylon cup with drip-catching device, 3/8M BSP thread
• Body thread: 1/4" BSP cylindrical gas thread
• Pressure and airflow regulator
• Jet regulator from round to fan spray pattern
• Paint quantity regulator
• Supplied with service spanner for maintenance operations

CE



	Ø mm	€	🔧	📄
1952 1,2	1,2	148,00	1	019520012
1952 1,5	1,5	148,00	1	019520015
1952 1,8	1,8	148,00	1	019520018
1952 2,0	2,0	148,00	1	019520020

1900S

automatic spring hose reel,
shockproof plastic body,
for use with air or water
• max. operating pressure: 15 bar
• braided polyurethane hose
• polypropylene frame
• device for automatically fixing hose at required length
• rack mechanism can be disabled to keep hose pulled
• water operating temperature range: -5 °C / +50 °C
• supplied with a 180° swivel bracket and an additional quick connection bracket

CE

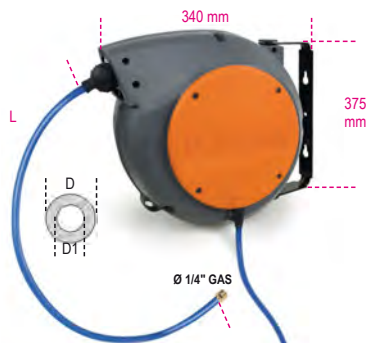

D1xD mm	L m	Ø GAS mm	€	🔧	📄
8x10	10	1/4"	161,00	1	019000080

1900M

automatic spring hose reel,
shockproof plastic body,
for use with air or water
• max. operating pressure: 15 bar
• braided polyurethane hose
• polypropylene frame
• device for automatically fixing hose at required length
• rack mechanism can be disabled to keep hose pulled
• water operating temperature range: -5 °C / +50 °C
• supplied with a 180° swivel bracket and an additional quick connection bracket

CE

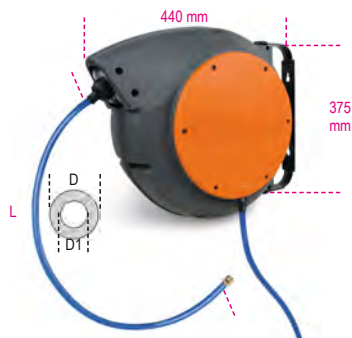

D1xD mm	L m	Ø GAS mm	€	🔧	📄
8x15	15	1/4"	264,00	1	019000085
10x15	15	3/8"	225,50	1	019000115

1914

polyurethane recoiled hoses, 98 Shore,
extendable
• Maximum operating pressure: 12 bar



L m	D1xD mm	Ø GAS BSP	€	🔧	📄
4	5x8	1/4"	23,00	1	019140054
6	5x8	1/4"	27,00	1	019140056
10	5x8	1/4"	35,00	1	019140060

1915B

polyurethane recoil hoses, 95 Shore,
extendable up to 9 m
• Maximum operating pressure: 10 bar

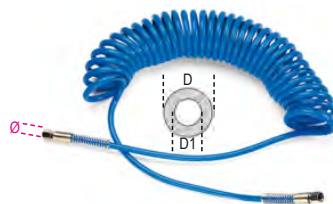

D1xD mm	Ø GAS BSP	€	🔧	📄
6,5x10	1/4"	40,00	1	019150011
8x12	1/4"	47,50	1	019150012
11x16	3/8"	77,00	1	019150013

1915C

polyurethane recoil hoses, 95 Shore, extendable up to 12 m

• Maximum operating pressure: 10 bar



D1xD mm	Ø GAS BSP	€	🔧	📄
6,5x10	1/4"	47,50	1	019150014
8x12	1/4"	58,50	1	019150015
11x16	3/8"	95,00	1	019150016

1915C/L

polyurethane recoil hoses, 95 Shore, extendable up to 15 m

• Maximum operating pressure: 10 bar



D1xD mm	Ø GAS BSP	€	🔧	📄
8x12	1/4"	75,50	1	019150115
11x16	3/8"	127,50	1	019150116

1915D

braided polyurethane hose, 95 Shore, 9 metres long

• Maximum operating pressure: 15 bar



D1xD mm	Ø GAS BSP	€	🔧	📄
8x12	1/4"	47,50	1	019150017
11x16	3/8"	75,50	1	019150018

1915E

braided polyurethane hose, 95 Shore, 12 metres long

• Maximum operating pressure: 15 bar



D1xD mm	Ø GAS BSP	€	🔧	📄
8x12	1/4"	63,50	1	019150019
11x16	3/8"	94,50	1	019150020

1915E/XL

braided polyurethane coils, 95 Shore, 50 m long

• Maximum operating pressure: 15 bar



D1xD mm	Ø GAS BSP	€	🔧	📄
8x12	1/4"	217,00	1	019150519
11x16	3/8"	363,00	1	019150520

1916I

quick couplings Italian profile male threaded, cylindrical (BSP)



Ø GAS BSP	€	🔧	📄
1/4"	2,78	5	019160001
3/8"	3,15	5	019160002

1916G

quick couplings European profile male threaded, tapered (BSPT)



Ø GAS BSPT	€	🔧	📄
1/4"	2,78	5	019160005
3/8"	3,65	5	019160010
1/2"	4,10	5	019160012

1916GF

quick couplings, Italian profile, female threaded, cylindrical (BSP)



Ø GAS BSP	€	🔧	📄
1/4"	2,78	5	019160055
3/8"	3,15	5	019160060

1916GFE

quick couplings, European profile, female threaded, tapered (BSPT)



Ø GAS BSPT	€	🔧	📄
1/4"	2,78	5	019160075
3/8"	3,65	5	019160082
1/2"	4,10	5	019160084

1916JM

quick couplings, Asian profile, male threaded, tapered (BSPT)



Ø GAS BSPT	€	🔧	📄
1/4"	3,90	1	019160406
3/8"	4,10	1	019160410

1916JF

quick couplings, Asian profile, female threaded, cylindrical (BSP)



Ø GAS BSPT	€	🔧	📄
1/4"	3,90	1	019160456
3/8"	4,10	1	019160460

1916P

quick couplings, Italian profile, with sleeve for rubber hose



D1xD mm	€	🔧	📄
6x14	3,65	5	019160256
8x17	3,95	5	019160258
10x19	5,30	5	019160260



1916S

quick couplings, Italian profile, with coil springs

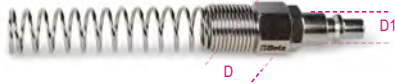

D1xD mm	€	🔧	📄
6x8	3,65	5	019160306
8x10	3,90	5	019160308
10x12	4,95	5	019160310

1917M

universal ball quick couplers, shockproof rubber, male threaded, cylindrical (BSP)

• Designed for couplings 1916I and 1916G



Ø GAS BSP	€	🔧	📄
1/4"	10,00	5	019170001
3/8"	10,00	5	019170003
1/2"	10,70	5	019170004

1917F

universal ball quick couplers, shockproof rubber, female threaded, cylindrical (BSP)

• Matches couplings 1916I and 1916G



Ø GAS BSP	€	🔧	📄
1/4"	10,40	5	019170005
3/8"	10,00	5	019170010
1/2"	11,00	5	019170014

1917JM

ball quick couplers, Asian profile, male threaded, cylindrical (BSP)



Ø GAS BSP	€	🔧	📄
1/4"	16,70	1	019170406
3/8"	16,70	1	019170410
1/2"	17,90	1	019170412

1917JF

ball quick couplers, Asian profile, female threaded, cylindrical (BSP)



Ø GAS BSP	€	🔧	📄
1/4"	16,70	1	019170456
3/8"	16,70	1	019170460

1917RG

rotary universal coupler

- Made of aluminium, female threaded, cylindrical (BSP) male threaded, cylindrical (BSP)
- Matches all couplings with Italian and European profiles
- Rotates freely, even without connected area



Ø GAS BSP	€	🔧	📄
1/4"	21,70	1	019170252

1917SP

universal ball quick couplers, with sleeve for rubber hose



D1xD mm	€	🔧	📄
6x14	10,70	5	019170206
8x17	11,10	5	019170208
10x19	12,80	5	019170210

1917ST

universal ball quick couplers, with coil springs



D1xD mm	€	🔧	📄
6x8	9,95	5	019170306
8x10	10,10	5	019170308
10x12	11,40	5	019170310

1918

hose tail fitting, male threaded



D1 mm	Ø GAS BSP	€	🔧	📄
6	1/8"	2,23	3	019180106
8	1/8"	2,23	3	019180108
6	1/4"	2,44	3	019180116
8	1/4"	2,57	3	019180118
10	1/4"	2,57	3	019180120
10	3/8"	2,90	3	019180130
12	3/8"	3,00	3	019180132
10	1/2"	4,00	3	019180140
12	1/2"	4,10	3	019180142

1918N

connecting nipples with tapered threads (BSPT)



Ø GAS	Ø1 GAS	€	🔧	📄
1/4"	1/4"	2,57	5	019180300
3/8"	3/8"	3,00	5	019180310
1/2"	1/2"	4,10	5	019180320

1918R

reducing nipples with tapered threads (BSPT)



Ø GAS	Ø1 GAS	€	🔧	📄
1/4"	3/8"	2,90	5	019180200
3/8"	1/2"	4,00	5	019180210

1919FE1/4

filter-regulator-lubricator



Air in/outlet	1/4" GAS BSPT
Pressure gauge inlet	1/8" GAS BSPT
Maximum air capacity	750 l/min
Maximum pressure	9,5 bar
Operating pressure	0,5 - 8,5 bar
Operating temperature	5 - 60 °C
Filter capacity	5 micron
Cup capacity	15 cc air / 25 cc oil
Weight	700 g

🔧	€	📄
700	100,50	1 019190200

1919RB-FE1/4

set of spare cups for item 1919FE1/4



1919RB-FE1/4 € 21,70 1 019190210

1919RF-FE1/4

spare filter for item 1919FE1/4



1919RF-FE1/4 € 5,90 1 019190230

1919RM-FE1/4

spare pressure gauge for item 1919FE1/4



1919RM-FE € 12,80 1 019190220

1919F1/4

filter-regulator-lubricator



Air in/outlet 1/4" GAS BSPT
Maximum air capacity 1000 l/min
Maximum pressure 9,5 bar
Operating pressure 0,5 - 8,5 bar
Operating temperature 5 - 60 °C
Filter capacity 5 microns
Cup capacity 60 cc air / 90 cc oil
Weight 1.3 kg

kg 1,3 € 158,00 1 019190250

1919F3/8

filter-regulator-lubricator



Air in/outlet 3/8" GAS BSPT
Maximum air capacity 1350 l/min
Maximum pressure 9,5 bar
Operating pressure 0,5 - 8,5 bar
Operating temperature 5 - 60 °C
Filter capacity 5 microns
Cup capacity 60 cc air / 90 cc oil
Weight 1.3 kg

kg 1,3 € 158,00 1 019190350

1919F1/2

filter-regulator-lubricator



Air in/outlet 1/2" GAS BSPT
Maximum air capacity 2500 l/min
Maximum pressure 9,5 bar
Operating pressure 0,5 - 8,5 bar
Operating temperature 5 - 60 °C
Filter capacity 5 microns
Cup capacity 60 cc air / 90 cc oil
Weight 1.3 kg

kg 1,3 € 158,00 1 019190450

1919RB-F

set of spare cups for filters
 item 1919F - 1/4", 3/8" and 1/2"



1919RB-F € 28,00 1 019190510

1919RF-F

spare filter for filters
 item 1919F - 1/4", 3/8" and 1/2"



1919RF-F € 11,00 1 019190530

1919RM-F

spare pressure gauge for filters
 item 1919F - 1/4", 3/8" and 1/2"



1919RM-F € 16,50 1 019190520

1919ML

mini lubricators



Ø	L mm	Ø mm	€	1	019190030
1/4"	63	36	20,40	1	019190030
3/8"	63	36	22,10	1	019190032

1919SC

mini water separator



Ø	L mm	Ø mm	€	1	019190035
1/4"	80	40	26,00	1	019190035

1919L

ISO 32 lubricating oil

Density 20°C
Viscosity 40°C
Flammability COC

875 Kg/m³
32 cSt
210°C



cc 500 € 17,90 5 019190050

TOOL BAGS AND RUCKSACKS MADE FROM TECHNICAL FABRIC

- **FUNCTIONALITY**
- **STURDINESS**
- **DURABILITY**

These are the three cornerstones of Beta's range of Fabric Containers. Beta's tool bags and rucksacks are made from sturdy technical fabric, resistant to both abrasion and wear, with reinforced bottoms and seams, translating into reliability and durability.

Each container has special characteristics, designed for different uses and space optimization: zipped pockets, telescopic handles, wheel protectors, reinforced shoulder straps and transparent document bags are but some of the peculiarities of each bag and rucksack.

Painstaking care for detail, variety and special attention to the completely safe transportation of the tools make these products ideal for every working situation.



POLYPROPYLENE TOOL CASES

Beta provides a wide range of technical cases catering to any needs! Beta's tool cases and trolleys are made from sturdy, thick, shockproof, corrosion-resistant polypropylene designed to withstand heavy-duty use – e.g. at low temperatures.

Choose the product that best fits your working requirements from the classic tool trolley, the wheeled trolley version for easy transport, the versions fitted with TSA locks for totally free travelling and, finally, the aluminium or watertight version.

Most of Beta's tool cases and trolleys are also available in combination with tool assortments satisfying different working needs, depending on the field of application: electronics, hydraulics, boating and maintenance.



2001/B26

fabric wallet with assortment of 26 tools



2001/B26 € 214,50 1 020010215

55 6x7 - 8x9 - 10x11 - 12x13 - 14x15 - 16x17 mm
 96N/SC9 1,5 - 2 - 2,5 - 3 - 4 - 5 - 6 - 8 - 10 mm
 1044F 250 mm
 1128BMX 145 mm
 1150 180 mm
 1201E 3x75 - 4x100 - 5,5x150 mm
 1202E PH1x80 - PH2x100 mm
 1370 300 g
 1692 2 m
 1770A 9 mm

2001/BV € 46,50 1 020010051

2001/BZV

tool case made from durable technical fabric

- Double upper handle for optimal hold
- Large front document pocket with zip closure
- Velcro strap at the back, for fixing the tool case to the trolley handle
- 20 convenient tool compartments (6 pockets and 14 elastic bands)
- Hammer loops
- Shoulder strap C9/RT can also be included (to be ordered separately)



2001/BZV € 43,00 1 020010151

380x290x60 mm - 675 g



2001/BZ24 MQ

folding tool case with assortment of 24 tools, for electricians



2001/BZ24 MQ € 313,00 1 020010154

1128BMX		1
1150MQ	180 mm	1
42	8-10-13-17-19 mm	5
1274MQ	3x100 - 4x100 - 5,5x125 mm	3
1272MQ	PH0x60 - PH1x80 - PH2x100 mm	3
96BP/SC9	1,5-2-2,5-3-4-5-6-8-10 mm	9
1253		1
1082MQ	160 mm	1

2001/BZ27 VU

folding tool case with assortment of 27 tools, for universal use



2001/BZ27 VU € 261,00 1 020010157

1128BMX		1
1150	180 mm	1
42	7-8-10-13-17-19 mm	6
1201E	3x75 - 4x100 - 5,5x150 mm	3
1202E	PH0x60 - PH1x80 - PH2x100 mm	3
96/SC9	1,5-2-2,5-3-4-5-6-8-10 mm	9
1370	300 g	1
1048	250 mm	1
1692/5	5 m	1
1771	18 mm	1

2002/BV6

roll-up tool wallet made of durable polyester, empty

- With 6 convenient, differently sized tool compartments
- Central handle made of reinforced fabric makes it easy to carry
- With interior flap preventing tools from coming out
- Reinforcement seams throughout wallet perimeter
- Double Velcro closure
- Dimensions when open: 175 x 240 mm



2002/BV6 € 7,50 1 020020000

2002/BVL6

roll-up tool wallet made of durable polyester, empty

- With 6 convenient, differently sized tool compartments
- Central handle made of reinforced fabric makes it easy to carry
- With interior flap preventing tools from coming out
- Reinforcement seams throughout wallet perimeter
- Double Velcro closure
- Dimensions when open: 220 x 290 mm



2002/BVL6 € 9,65 1 020020010

2002/BV7-ZIP

roll-up tool wallet made of durable polyester, empty

- With 7 convenient, differently sized compartments and small tool pocket with zip closure
- Central handle made of reinforced fabric makes it easy to carry
- With interior flap preventing tools from coming out
- Reinforcement seams throughout wallet perimeter
- Double Velcro closure
- Dimensions when open: 355 x 220 mm



2002/BV7-ZIP € 17,20 1 020020060

2002/BV8

roll-up tool wallet made of durable polyester, empty

- With 8 convenient, differently sized tool compartments
- Central handle made of reinforced fabric makes it easy to carry
- With interior flap preventing tools from coming out
- Reinforcement seams throughout wallet perimeter
- Double Velcro closure
- Dimensions when open: 395 x 360 mm



2002/BV8 € 9,65 1 020020020

2002/BV9

roll-up tool wallet made of durable polyester, empty

- With 9 convenient, differently sized tool compartments
- Central handle made of reinforced fabric makes it easy to carry
- With interior flap preventing tools from coming out
- Reinforcement seams throughout wallet perimeter
- Double Velcro closure
- Dimensions when open: 325 x 290 mm



2002/BV9 € 9,65 1 020020030

2002/BV12

roll-up tool wallet made of durable polyester, empty

- With 12 convenient, differently sized tool compartments
- Central handle made of reinforced fabric makes it easy to carry
- With interior flap preventing tools from coming out
- Reinforcement seams throughout wallet perimeter
- Double Velcro closure
- Dimensions when open: 650 x 355 mm



2002/BV12 € 16,00 1 020020040

2002/BV13

roll-up tool wallet made of durable polyester, empty

- With 13 convenient, differently sized tool compartments
- Central handle made of reinforced fabric makes it easy to carry
- With interior flap preventing tools from coming out
- Reinforcement seams throughout wallet perimeter
- Double Velcro closure
- Dimensions when open: 330 x 190 mm



2002 BV13	€ 9,65	1	020020050
-----------	--------	---	-----------

2005PA/D

tool pouch, empty, made from nylon, with belt



2005PA/D	€ 58,50	1	020050000
----------	---------	---	-----------

2005PA/S

tool pouch, empty, made from nylon, with belt



2005PA/S	€ 29,50	1	020050020
----------	---------	---	-----------

Beta
Quality Tools

2009N/BV

leather bag for maintenance



mm	€		
530x190x210	246,50	1	020090200

2009ID

bag with assortment of tools for plumbing maintenance



2009ID (2009N/BV+5980ID)	€ 798,00	1	020091013
-----------------------------	----------	---	-----------

2028/VV

tool case, made of polypropylene

2 tool panels
Interior bottom with removable partitions
Double combination lock



mm	€		
470x410X185 mm	222,00	1	020280010

2028E

tool case with assortments of tools for electronic and electrotechnical maintenance



2028EL/A (2028/VV+5980EL/A)	€ 1.075,00	1	020281014
2028ET/A (2028/VV+5980ET/A)	1.090,00	1	020281018

2029/VV

tool case, made of thick polypropylene, aluminium edged

2 tool panels
Bottom with removable and adjustable partitions
Supplied with shoulder strap
2 keyed locks



mm	€		
490x380x230	317,00	1	020290000

2029E

tool cases with assortments of tools for electronic and electrotechnical maintenance



2029 BG MQ (2029/VV+5980MQ)	€ 1.930,00	1	020291257
2029ET/B (2029/VV+5980ET/B)	1.505,00	1	020291021
2029EL/B (2029/VV+5980EL/B)	1.520,00	1	020291017

2029/RT

universal shoulder strap for bags and cases



2029/RT	€ 21,00	1	020290900
---------	---------	---	-----------



2032/TV

tool trolley, made from plastic

2 tool panels
Tool pocket
Interior bottom with removable partitions



mm € 1 020320110
430x370x200 409,00

2032/TE

tool trolley with assortments of tools for electronic and electrotechnical maintenance



€ 1 020321328
1.275,00
2032TET/A (2032/TV+5980ET/A)
€ 1 020321314
1.260,00
2032TEL/A (2032/TV+5980EL/A)

2033L/VV

wall tool case, made from aluminium, empty

- Highly shock resistant
- Nonscratch finish
- Ergonomic handle with rubber grip
- Double closure with combination

- 2 tool panels with elastic bands
- Interior bottom with removable partitions



mm € 1 020330250
470x375x205 320,00

2033L

aluminium tool cases with assortments of tools for electronic and electrotechnical maintenance



2033LEL/A (2033L/VV+5980EL/A)	€ 1.173,00	1 020331224
2033LEL/B (2033L/VV+5980EL/B)	€ 1.525,00	1 020331225
2033LET/B (2033L/VV+5980ET/B)	€ 1.505,00	1 020331237

2036/TV

tool trolley, made of thick polypropylene, aluminium edged

2 tool panels
Telescopic handle
Ball bearing castors



mm € 1 020360000
490x380x260 478,00

2036E

trolley with assortments of tools for electronic and electrotechnical maintenance



2036TET/B (2036/TV+5980ET/B)	€ 1.665,00	1 020361223
2036EL/B (2036/TV+5980EL/B)	€ 1.680,00	1 020361218

2037/TV

tool trolley, made of thick polypropylene, with 4 pivoting castors

Highly shock resistant. Suitable for tool transportation in aircraft.
2 removable tool panels.
Built-in document pocket.
4 removable pivoting castors for horizontal trolley handling.
2 tote-trays included
2 TSA approved locks with keys
Rubber-coated handle



mm € 1 020370000
420x325x275 590,00

2038/TV

tool trolley, made of thick polypropylene

- Highly shock resistant
- Aluminium sealing profile
- 2 TSA approved locks with keys
- 2 removable tool panels.
- Telescopic handle and big ball bearing castors
- 2 ergonomic rubber-coated handles (including 1 side handle)
- Capacious bottom
- Document pocket
- 3 tote drawers



mm € 1 020380000
430x500x340 782,00



2041UC

Utility Case with assortment of 33 tools



2041UC € 325,00 1 020410215

- 55 6x7 - 8x9 - 10x11 - 12x13 - 14x15 - 16x17 mm
- 96/SC9 1,5 - 2 - 2,5 - 3 - 4 - 5 - 6 - 8 - 10 mm
- 111 200 mm
- 1048V 250 mm
- 1128BMX 145 mm
- 1150 180 mm
- 1201E 2,5x50 - 3x75 - 4x100 - 5,5x100 - 6,5x150 mm
- 1202E PH0x60 - PH1x80 - PH2x100 mm
- 1370 300 g
- 1692 3m
- 1771 170 mm
- 1833S 70 Lumen / 140 mm
- 1639NS-N 25m
- 1696 200 mm

535x282x87 mm - 4,5 Kg

2051N

assortment of 55 tools
for nautical maintenance
with shockproof polypropylene case



2051N € 761,00 1 020510215

- 42 7 - 8 - 10 - 12 - 13 - 14 - 17 - 19 mm
- 55AS 3/8x7/16 - 1/2x9/16 - 5/8x11/16"
- 956C □1/2 - 16 - 20,8 mm
- 1048 250 mm
- 1084BM 160 mm
- 1128BMX 145 mm
- 1150BM 180 mm
- 1166BM 160 mm
- 1201E ●3x75 - 4x100 - 5,5x150 - 6,5x150 mm
- 1202E ●PH1x80 - PH2x100 mm
- 1390 Ø 35 mm
- 1490/2 ø max 240 mm
- 96/SC9 ○1,5+10 mm
- 1737 145 mm
- 1778X
- 1748N 3,6 x 140 mm
- 1639NS-N 25m
- 111 200 mm
- 920A ○ 10 - 12 - 13 - 14 - 17 - 19 mm
- 920AS ○ 7/16 - 1/2 - 9/16 - 11/16 - 7/8"
- 920/22 255 mm - □1/2 - □1/2
- 920/25 □1/2 - ■1/2
- 920/42 ■1/2
- 920/55 ■1/2

585x393x92 mm - 9 kg

2055HB

"Home Bag" case with assortment of 24 tools



2055HB € 194,50 1 020550215

- 55 6x7 - 8x9 - 10x11 - 12x13 mm
- 96N/SC9 1,5 - 2 - 2,5 - 3 - 4 - 5 - 6 - 8 - 10 mm
- 1128BMX 145 mm
- 1150 180 mm
- 1048V 250 mm
- 1201E 3x75 - 4x100 - 5,5x100 mm
- 1202E PH0x60 - PH1x80 - PH2x100 mm
- 1370 300 g
- 1692 3m

373x275x70 mm - 3 Kg

2060/VV

hard cavity wall tool case

Floating, waterproof/watertight
Made from thick resin
With manual pressure release valve



IP67

490x410x210 mm € 427,00 1 020600101

2080/V6

organizer tool case with 6 removable tote-trays
and adjustable partitions



2080/V6 mm € 34,50 1 020800060

2080/V6-U

removable tote-tray for organizer tool case
2080/V6



2080/V6-U € 2,56 1 020800066

90x60x50 mm

2080/D10

set of 10 adjustable partitions for organizer
tool case 2080/V6



2080/D10 € 6,80 1 020800070

2080/V12

organizer tool case with 12 removable tote-
trays



2080/V12 mm € 53,50 1 020800000

2080/V12-...

removable tote-tray for organizer tool case
2080/V12



	€	📦	🏠
2080/V12-S 95x75x65 mm	3,25	3	020800013
2080/V12-M 145x75x65 mm	4,85	2	020800015
2080/V12-L 295x75x65 mm	8,40	1	020800020

C3

mini tool bag, made from technical fabric

Main features:

- 1 exterior front pocket with zip closure
- 2 side pockets with tote trays
- 1 convenient rear pocket with Velcro closure
- 1 removable interior tool panel, with elastic bands on both sides
- USB interface for charging mobile devices
- Complete with shoulder strap



	€	📦	🏠
C3 330x320x150 mm - 890 g	59,00	1	021030000

C4 - 2104

tool basket made of technical fabric

- Removable internal tool panel
- Internal and external pockets and elastic tool holder
- Sturdy waterproof base with rubber feet
- Supplied with shoulder strap



	€	📦	🏠
C4 2104VU/0 (C4+5915VU/0)	99,50 479,00	1 1	021040000 021041122
360x330x260 mm - 2,5 kg			

C5S

tool rucksack, made of hard-wearing polyester

- Double handle on top centre of rucksack for firm, balanced hold
- Two large front pockets
- Two capacious interior pockets and 2 additional Velcro straps
- Handy roll-up interior bag, composed of 4 tool panels
- Adjustable reinforced shoulder straps
- Maximum carrying capacity: 15 kg



	€	📦	🏠
C5S 370x300x100 mm - 0,9 Kg	50,50	1	021050100

C5 - 2105

tool rucksack, made of technical fabric



	€	📦	🏠
C5 2105VU/0 (C5+5915VU/0)	142,00 522,00	1 1	021050000 021051122
500x400x180 mm - 2,5 Kg			

C6T - 2106

tool rucksack, made of technical fabric, with castors



	€	📦	🏠
C6T 2106T/VU/0 (C6T+5915VU/0)	202,00 582,00	1 1	021060010 021061122
480x370x220 mm - 4,5 kg			

Beta
Quality Tools

Beta
Quality Tools

C7 - 2107

technical fabric tool bag

- 2 removable interior tool panels
- Interior PC pocket
- 2 exterior front pockets
- Interior bottom made of plastic, with removable partitions



	€		
C7	210,00	1	021070000
2107VU/2 (C7+5915VU/2)	616,00	1	021071112
2107VU/3 (C7+5915VU/3)	1.060,00	1	021071114

440x370x170 mm - 3,5 kg

C8 - 2108

technical fabric tool trolley



	€		
C8	237,00	1	021080000
2108 VU/1 (C8+5915VU/1)	698,00	1	021081022

470x370x280 mm - 4 kg

C8B

tool trolley made from technical fabric, for electricians

- Hard frame
- Telescopic carrying handle
- 4 castors
- 1 removable interior tool panel
- Front pocket with badge holder
- Double bottom complete with tote tray
- 2 exterior side pockets
- 2 wire puller hooks
- Tilting handle for easier access to tools
- Can be padlocked (padlock not included)



	€		
C8B	191,50	1	021080300

430x290x440 mm - 4,7 kg

C9 - 2109

technical fabric tool bag

- Hard base
- Interior and exterior tool pockets
- Exterior pocket with zip closure for enhanced safety
- Pocket with strap closure for personal belongings
- Double bottom
- Double string for levels
- Shoulder strap for easier transport



	€		
C9	115,00	1	021090000
2109VU/1 (C9+5915VU/1)	576,00	1	021091022
2109VU/3 (C9+5915VU/3)	965,00	1	021091024

550x280x320 mm - 2,6 kg

C9/RT

shoulder strap for items

C4,C7,C9,C10,C10S,C11 and C12



	€		
C9/RT	14,80	1	021090900

C10 - 2110

technical fabric tool box

- Hard frame
- Double bottom. Bottom can be removed for increased bag capacity
- Tilting handle for easier access to tools
- Elastic tool bands and interior and exterior pockets
- Cover
- Tool tray included in double bottom



	€		
C10	143,00	1	021100000
2110VU/1 (C10+5915VU/1)	604,00	1	021101031
2110VU/3 (C10+5915VU/3)	993,00	1	021101034
2110VU/AS (C10+5915VU/AS)	1.077,00	1	021101036

520x220x250 mm - 3,3 kg

C10S - 2110S

technical fabric tool box

- Hard frame
- Double bottom. Bottom can be removed for increased bag capacity
- Tilting handle for easier access to tools
- Elastic tool bands and interior and exterior pockets
- Cover
- Tool tray included in double bottom



	€		
C10S	112,50	1	021100001
2110SVU/1 (C10S+5915VU/1)	573,00	1	021101041
2110SVU/3 (C10S+5915VU/3)	963,00	1	021101044

420x220x250 mm - 2,3 kg



C11 - 2111

technical fabric tool box



	€		
C11	84,00	1	021110000
2111VU/1 (C11+5915VU/1)	545,00	1	021111031
2111VU/3 (C11+5915VU/3)	934,00	1	021111034

400x240x220 mm - 2 kg

C12 - 2112

technical fabric tool bag

Removable interior tool panel
Elastic tool bands and capacious interior and exterior pockets
Bag opens at front for easier access to tools at workplace
Hard, waterproof base with rubber feet
Can be used with trolley C8



	€		
C12	182,50	1	021120000
2112ET/A (C12+5980ET/A)	1.050,00	1	021121028
2112ET/B (C12+5980ET/B)	1.370,00	1	021121029
2112VU/5 (C12+5915VU/5)	1.265,00	1	021121056

500x370x270 mm - 5 kg

C13

tool trunk with castors,
made of hard-wearing polypropylene

Suitable for outdoor use
Shockproof, resistant to chemical agents
Can be padlocked



	€		
C13	298,00	1	021130000

870x410x350 mm - 7,2 kg

C14

tool trolley, made of polypropylene, with 4 drawers

- Injection polypropylene frame for increased shock resistance.
- Lid-protected front accommodates 4 pull-out drawers (470x255):
1 drawer 30 mm high
2 drawers 60 mm high
1 drawer 90 mm high
- Front centralized lock allows top and front lids to be closed simultaneously.
- Two side handles
- 4 sturdy rear castors
- Removable top tray
- Tool panel built into lid
- 3 tote-trays included
- Nameplate
- Can be closed with TSA lock



	€		
C14	761,00	1	021140000
2114VU/M (C14+5914VU/M)	1.775,00	1	021141011

580x380x455 mm - 10 kg

CP15 - 2115

tool box, made from plastic, removable tote-tray and tool trays

- 1 tool tray built into cover
- 2 removable tool trays with adjustable partitions
- 1 interior tote-tray with adjustable partitions



	€		
CP15	43,00	1	021150201
2115PVU/1 (CP15+5915VU/1)	504,00	1	021151232
2115PVU/2 (CP15+5915VU/2)	449,00	1	021151234

445x240x250 mm - 2 kg

CP15L - 2115

tool box, long series, made from plastic,
removable tote-tray and tool trays

- 3 tool trays built into cover with adjustable partitions
- 1 interior tote-tray with adjustable partitions



	€		
CP15L	58,00	1	021150202
2115PL-VU/1 (CP15L+5915VU/1)	519,00	1	021151242
2115PL-VU/3 (CP15L+5915VU/3)	908,00	1	021151245

558x277x270 mm - 2,5 kg





2115P L-MQ32

assortment of 32 insulated tools for hybrid cars, in plastic tool box with soft thermoformed tray



2115PL-MQ32	€ 1.116,00	1	021150332
--------------------	------------	---	-----------

920MQ/55A

89MQ 10-12 mm

850MQ 1/4"

860TX/A10 T7-T8-T9-T10-T15-T20-T25-T27-T30-T40

920MQ/A 8-10-12-13-14-17-19 mm

920MQ/21 125mm

920MQ/22 250mm

1048MQ250 250mm

1150MQ 180mm

1164MQ160 160mm

1272MQ 4.5X80-6X100mm

1274MQ 3X100-4X100-5.5X125

1995MQ/G2 G2

CP15L

C16 - 2116

tool box, made of plastic, with interior object compartment, empty



C16	€ 95,00	1	021160000
2116VU/1 (C16+5915VU/1)	556,00	1	021161102
2116VU/3 (C16+5915VU/3)	945,00	1	021161105

≡ 500x260x260 mm - 2,5 kg

CP17 - CP17L - 2117

tool box, made of stainless steel and plastic, removable tote-tray



CP17
≡ 500x200x220 mm



CP17L
≡ 575x245x265 mm

CP17	€ 79,50	1	021170500
2117P-VU/1 (CP17+5915VU/1)	540,00	1	021171042
2117P-VU/3 (CP17+5915VU/3)	930,00	1	021171045
CP17L	114,50	1	021170502
2117L-VU/1 (CP17L+5915VU/1)	575,00	1	021171142
2117PL-VU/3 (CP17L+5915VU/3)	965,00	1	021171145

C18 - 2118

tool box made from sheet metal



C18	€ 37,50	1	021180001
2118VU/1 (C18+5915VU/1)	498,00	1	021181032

≡ 450x200x100 mm - 3 kg

C19 - 2119 - C19L - 2119L

three-section cantilever tool box, made from sheet metal



C19
≡ 450x200x160 mm



C19L
≡ 550x200x160 mm

C19	€ 49,50	1	021190001
2119VU/3 (C19+5915VU/3)	900,00	1	021191025
C19L	64,00	1	021190002
2119L-VU/3 (C19L+5915VU/3)	914,00	1	021191125

C20 - C20L - 2120

five-section cantilever tool box, made from sheet metal



C20
≡ 450x200x210 mm



C20L
≡ 550x200x210 mm

C20	€ 70,00	1	021200001
2120VU/2 (C20+5915VU/2)	476,00	1	021201061
2120VU/3 (C20+5915VU/3)	920,00	1	021201063
2120VU/4 (C20+5915VU/4)	1.173,00	1	021201064
2120VU/AS (C20+5915VU/AS)	1.004,00	1	021201068
C20L	76,50	1	021200002
2120L-VU/2 (C20L+5915VU/2)	483,00	1	021201161
2120L-VU/3 (C20L+5915VU/3)	927,00	1	021201163
2120L-VU/4 (C20L+5915VU/4)	1.179,00	1	021201164
2120L-VU/AS (C20L+5915VU/AS)	1.011,00	1	021201168



C20TSS

five-section cantilever tool box, made of AISI 304 stainless steel



C20TSS € 273,00 1 021203001

450x200x210 mm - 4kg

C22B

tool trunk, made of sheet metal



C22B O

720x320x310 mm



C22BM O

850x360x350 mm



C22BL O

1010x410x400 mm

C22B-O € 198,50 1 022000150
C22BM-O € 228,50 1 022000160
C22BL-O € 305,00 1 022000170

C22B O: 13 kg
C22BM O: 20 kg
C22BL O: 26 kg

C22W

tool trunk, made from sheet metal, lined for enhanced tool protection



C22W O

690x300x360 mm



C22WL O

990x300x360 mm

C22W-O € 221,00 1 022000269
C22WL-O € 288,00 1 022000299

C22W O: 15 kg
C22WL O: 28 kg

C22P

tool trunk for building yards, made of sheet metal

built-in, retractable handles
raised shoes for forklift truck handling
double burglar-proof lock closure (not included)



C22PM O

915x540x430 mm



C22PL O

1220x720x615 mm

C22PM-O € 592,00 1 022000240
C22PL-O € 914,00 1 022000245

C22PM O: 39 kg
C22PL O: 67 kg

Beta



C99

Combo is Beta's new modular system comprised of **3 different types of sturdy tool cases** for replacing your work equipment tidily and totally safely. The tool cases can be easily joined to each other by a **simple click**, through the functional side snap-on mechanism.

The new system, Beta Combo C99, is compatible with the L-BOXX standard by Sortimo®.

C99

BETA COMBO comprehensive modular system

The tool cases can be easily joined to each other by a simple click, through the functional side snap-on mechanism.

System comprising:

- Ultracompact aluminium folding trolley with telescopic handle C99P (485x520x1195 mm)
- ABS tool case C99V1 (445x358x152 mm)
- ABS tool case C99V2 (445x358x254 mm)
- ABS tool case with 2 portable tote trays C99V3/2C (445x358x322 mm)



C99

€ 632,00 1 099000010

C99V0

COMBO ABS tool case, with transparent cover

The tool cases can be easily joined to each other by a simple click, through the functional side snap-on mechanism.

Main features:

- Transparent cover made from sturdy polycarbonate for quick identification of contents
- Outer dimensions: 445x358x118 mm
- Max. interior carrying capacity: 25 kg
- Can be padlocked
- Weight: 2.5 kg

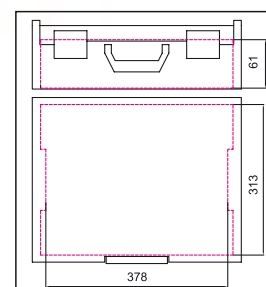

C99V0

€ 105,00 1 099000202

C99V0-P12

COMBO ABS tool case, with transparent cover

The tool cases can be easily joined to each other by a simple click, through the functional side snap-on mechanism.

Main features:

- Transparent cover made from sturdy polycarbonate for quick identification of contents
- Particularly suitable for carrying smallwares, including screws, nuts, washers, rivets and dowels
- Supplied complete with kit of 18 tote trays:
 - 2 red trays, 52x52 mm
 - 3 yellow trays, 104x52 mm
 - 2 blue trays, 104x104 mm
 - 1 green tray, 104x156 mm
 - 2 orange trays, 208x52 mm
 - 2 grey trays, 312x71 mm, and 6 adjustable partitions
- Outer dimensions: 445x358x118 mm
- Max. interior carrying capacity: 25 kg
- Can be padlocked
- Weight: 3.2 kg

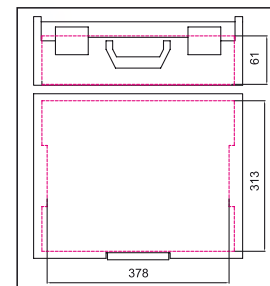

C99V0-P12

€ 149,00 1 099000200

C99P12-V0

kit of 18 tote trays for tool cases C99V0

Kit contents:

- 2 red trays, 52x52 mm
- 3 yellow trays, 104x52 mm
- 2 blue trays, 104x104 mm
- 1 green tray, 104x156 mm
- 2 orange trays, 208x52 mm
- 2 grey trays, 312x71 mm, and 6 adjustable partitions



C99P12-V0

€ 44,00 1 099000499



C99V1

COMBO ABS tool case

The tool cases can be easily joined to each other by a simple click, through the functional side snap-on mechanism.

Main features:

- Outer dimensions: 445x358x152 mm
- Max. interior carrying capacity: 25 kg
- Can be padlocked
- Weight: 2.2 kg

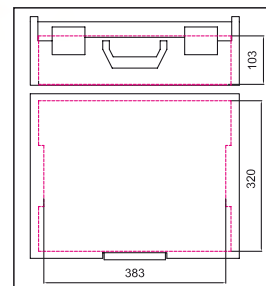

C99V1

€ 106,50 1 099000250

C99V2

COMBO ABS tool case

The tool cases can be easily joined to each other by a simple click, through the functional side snap-on mechanism.

Main features:

- Outer dimensions: 445x358x254 mm
- Max. interior carrying capacity: 25 kg
- Weight: 2.8 kg

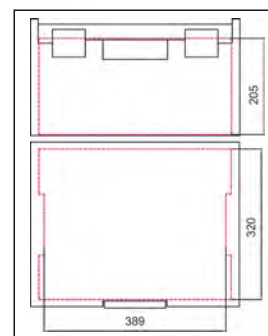

C99V2

€ 118,00 1 099000350

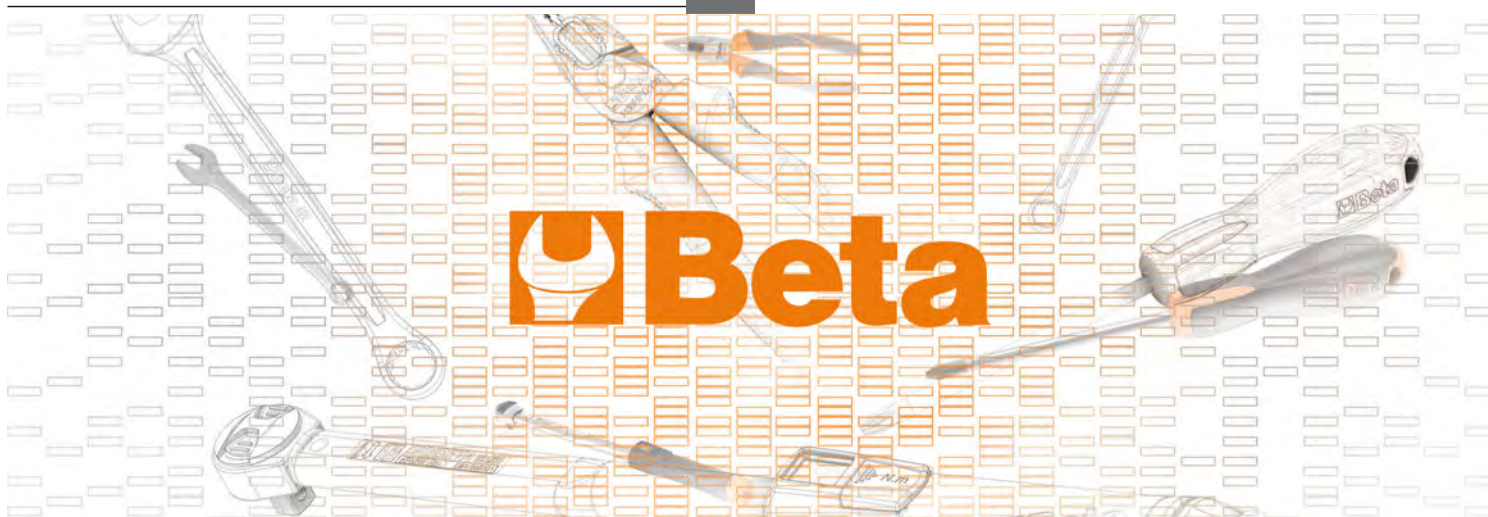

C99V3/2C

COMBO ABS tool case with 2 portable tote trays

The tool cases can be easily joined to each other by a simple click, through the functional side snap-on mechanism.

Main features:

- Outer dimensions: 445x358x322 mm
- Max. interior carrying capacity: 25 kg
- Supplied with 2 tote trays C99C-V3, empty
- Weight: 5.6 kg

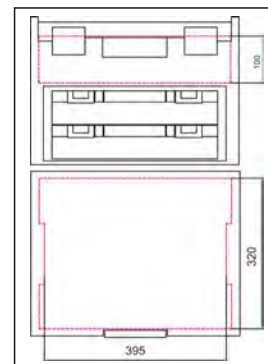

C99V3/2C

€ 227,00



1

099000450

C99C-V3

COMBO portable tool box

Transparent cover for quick identification of contents

Built-in handle

Outer dimensions: 367x316x72 mm

Weight: 0.9 kg

Can be equipped with:

- 7 compartment thermoformed tote tray C99T-V3
- kit of 17 tote trays item C99P-V3

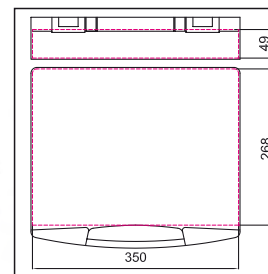

C99C-V3

€ 36,00



1

099000496

C99P

COMBO folding tool trolley

Main features:

- Ultracompact folding tool trolley
- Telescopic handle
- Dimensions when open: 485x520x1095 mm
- Dimensions when closed: 485x80x810 mm
- Dimensions of folding base: 485x350 mm
- Two puncture proof wheels, Ø 175



C99P

€ 180,50



1

099000101

C99PC

cover lining for wall tool cases C99V1 and C99V3/2C

Required in combination with thermoformed trays, to prevent the contents from coming out of the compartments or getting mixed up during transportation.



C99PC

€ 17,10 1 099000491

C99T

thermoformed tote tray, 4-compartment, for tool cases C99V1 and C99V3/2C



C99T

€ 24,90 1 099000492

C99M

soft foam insert, pre-cubed, for COMBO tool cases C99V1, C99V2 and C99V3/2C

Easy to shape, for safe, customized accommodation of any tools

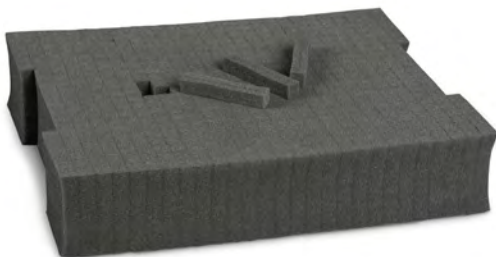

C99M

€ 43,00 1 099000494

C99T-V3

thermoformed tote tray with 7 compartments, for tool boxes C99C-V3



C99T-V3

€ 12,50 1 099000497

C99P-V3

kit of 17 tote trays for tool boxes C99C-V3

Kit contents:

- 6 red trays 52x52 mm
- 2 yellow trays 104x52 mm
- 3 grey trays 78x260 mm and 6 partitions



C99P-V3

€ 35,00 1 099000498

C99PP

tool panel for COMBO cases

- with 6 pockets and 11 elastic tool bands
- supplied complete with hooks for fixing panel into case cover



C99PP

€ 46,00 1 099000489



RSC22

portable tool chest with 3 drawers

Main features:

- 3 drawers (588x277 mm) with ball bearing slides:
- 1 drawer, 50 mm high
- 2 drawers, 70 mm high.
- Front centralized lock.
- Retractable side handles for ease of handling.

19 kg



RSC22-O



RSC22-A



RSC22-R



h	max
50 mm	25 kg
70 mm	25 kg

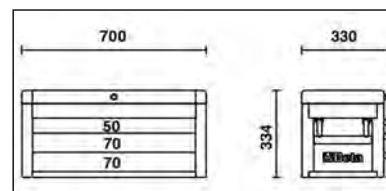
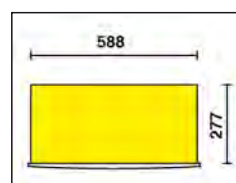

	€	1	022003001
RSC22-O	400,00	1	022003001
RSC22-R	400,00	1	022003003
RSC22-A	400,00	1	022003007

RSC23

portable tool chest
with 5 drawers

Main features:

- 5 drawers (588x277 mm)
- with ball bearing slides:
- 2 drawers, 50 mm high
- 3 drawers, 70 mm high.
- Front centralized lock.
- Retractable side handles for ease of handling.

📦 26 kg



RSC23-A



RSC23-R



RSC23-O



h		max
	50 mm	25 kg
	70 mm	25 kg

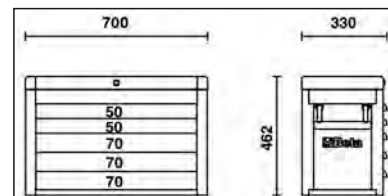
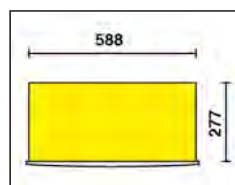

	€	📦	🖨️
RSC23-O	498,00	1	023003001
RSC23-R	498,00	1	023003003
RSC23-A	498,00	1	023003007

CD23S

Caddy trolley

Main features:

- ABS-coated worktop designed to match tool chests C22S, C23S, C23SC, C23ST
- Removable handle, can be stored underneath chassis.
- Four castors, Ø 100 mm: 2 fixed and 2 steering (one with brake).
- Maximum load capacity: 250 kg.

📦 14 kg



	€	📦	🖨️
CD23S	226,50	1	023000610

RSC23C

portable tool chest
with 8 drawers

Main features:

- 8 drawers (588x277 mm) with ball bearing slides:
- 4 drawers, 50 mm high
- 3 drawers, 70 mm high
- 1 drawer, 100 mm high.
- Front centralized lock.
- Retractable side handles for ease of handling.

📦 28 kg



RSC23C-A



RSC23C-R



RSC23C-O



h		max
	50 mm	25 kg
	70 mm	25 kg

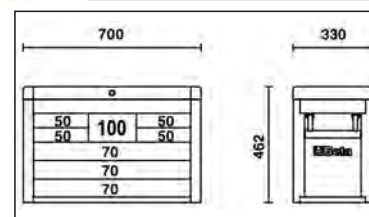
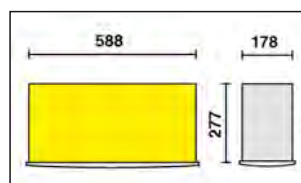

	€	📦	🖨️
RSC23C-O	562,00	1	023003011
RSC23C-R	562,00	1	023003013
RSC23C-A	562,00	1	023003017

RSC23T

portable tool chest
with 5 drawers

Main features:

- 5 drawers (588x367 mm) with ball bearing slides:
- 5 drawers, 70 mm high.
- Front centralized lock.
- Can be fitted with kit of 4 castors and 1 handle (2300ST/KIT)

📦 36 kg



RSC23T-A



RSC23T-B



RSC23T-G



RSC23T-N



RSC23T-R



RSC23T-O



RSC23T-FO

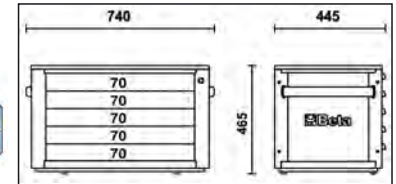
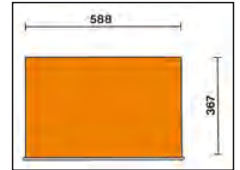
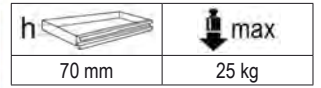

	€	📦	🖨️
RSC23T-FO	622,00	1	023003020
RSC23T-O	622,00	1	023003021
RSC23T-G	622,00	1	023003022
RSC23T-R	622,00	1	023003023
RSC23T-B	622,00	1	023003026
RSC23T-A	622,00	1	023003027
RSC23T-N	622,00	1	023003029

2300ST/KIT

kit with 4 castors and 1 handle for C23ST

- Four castors, Ø 125 mm:
2 fixed and 2 steering (one with brake).
- Telescopic handle

📦 6,5 kg

	€	📦	🖨️
2300ST/KIT	182,00	1	023000950

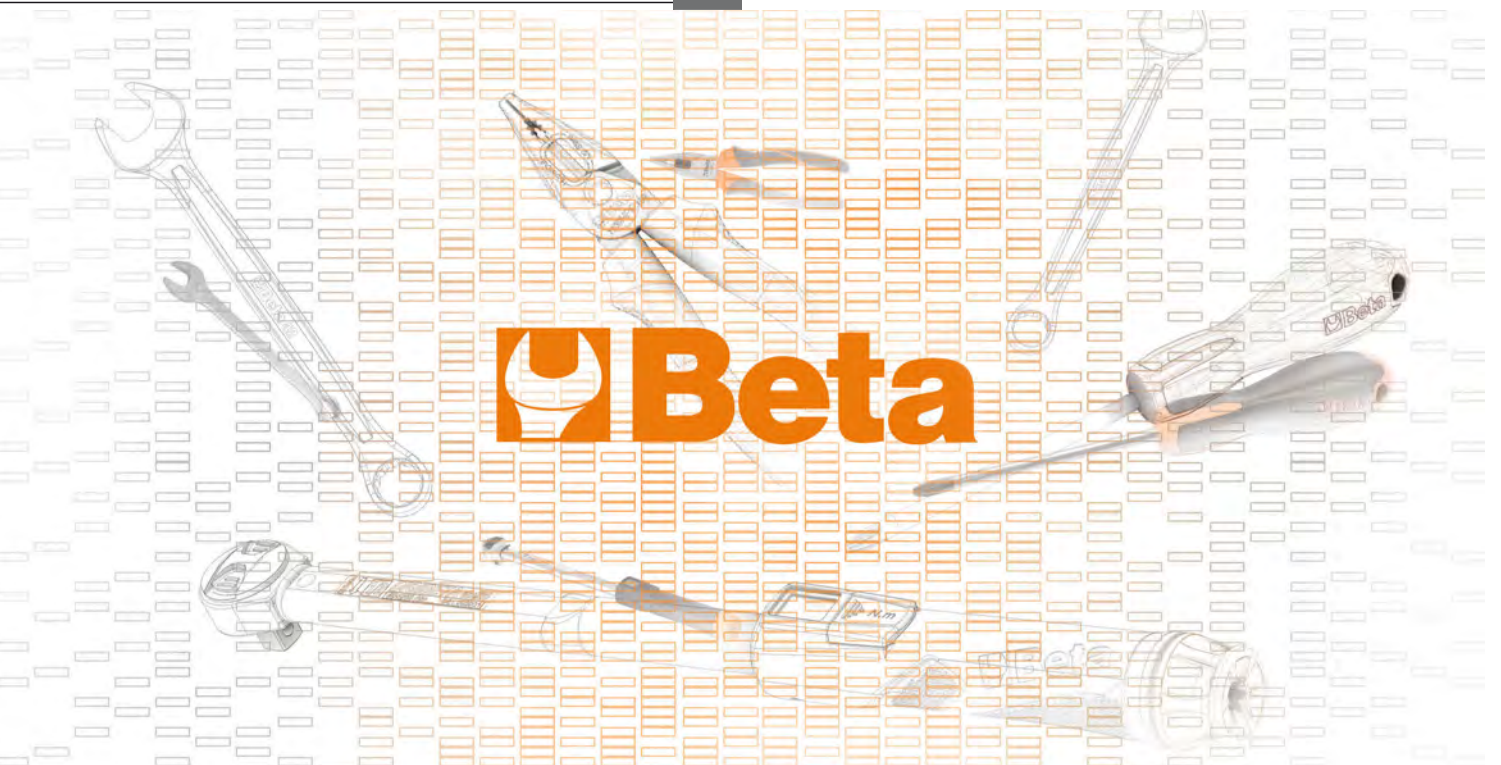

MOBILE ROLLER CAB RSC24

Beta
RSC24



NEW WORKTOP

**FIRMER AND STURDIER
MORE CONVENIENT
AND FUNCTIONAL
MORE MODERN**



- Drawers with ball bearing slides
- Drawer bases protected by foamed rubber mats
- Each drawer can accommodate up to 4 EVA foam or ABS thermoformed trays
- New ABS reinforced worktop, designed to support tool chests RSC22, RSC23, RSC23C and RSC23T
- Multi-purpose top with anti-fall edges and eight holes for accommodating screwdrivers
- Front centralized safety lock
- Four castors Ø 125 mm: 2 fixed and 2 steering (one with brake)
- Static load capacity: 800 kg

Available models:

- RSC24/5 (5 drawers)
- RSC24/6 (6 drawers)
- RSC24/7 (7 drawers)
- RSC24/8 (8 drawers)

Available colours:

RSC24-		
FO	RAL 2011	RAL 2011
O	RAL 7016	RAL 2011
G	RAL 7016	RAL 9006
R	RAL 7016	RAL 3000
B	RAL 7016	RAL 5015
A	RAL 7016	RAL 7016
N	RAL 9005	RAL 9005

Available accessories:

2400 RSC24/PF	2400 RSC24/SPC	2400 RSC24/PL
2400 RSC24/PF-A 2400 RSC24/PF-N	2400 RSC24/PD-A 2400 RSC24/PD-N	2400 RSC24/PC-A 2400 RSC24/PC-N
5000MS		

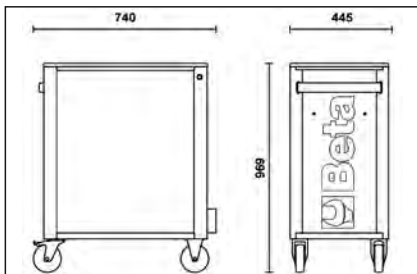
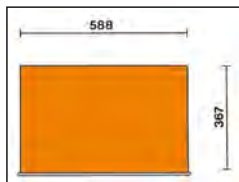

RSC24/7

mobile roller cab with 7 drawers

Main features:

- 7 fully removable drawers (588x367 mm), with ball bearing slides:
- 5 drawers, 70 mm high
- 1 drawer, 140 mm high
- 1 drawer, 210 mm high

63 kg

Model	Price (€)	Qty	Code
RSC24/7-FO	907,00	1	024004070
RSC24/7-O	907,00	1	024004071
RSC24/7-G	907,00	1	024004072
RSC24/7-R	907,00	1	024004073
RSC24/7-B	907,00	1	024004076
RSC24/7-A	907,00	1	024004077
RSC24/7-N	907,00	1	024004079



Beta
RSC24



RSC24/7-FO



RSC24/7-A



RSC24/7-B



RSC24/7-G



RSC24/7-N



RSC24/7-R



h		max
70 mm		25 kg
140 mm		30 kg
210 mm		30 kg

RSC24/5

mobile roller cab with 5 drawers

Main features:

- 5 fully removable drawers (588x367 mm), with ball bearing slides:
- 2 drawers, 70 mm high
- 2 drawers, 140 mm high
- 1 drawer, 280 mm high

60 kg

	€		
RSC24/5-FO	769,00	1	024004050
RSC24/5-O	769,00	1	024004051
RSC24/5-G	769,00	1	024004052
RSC24/5-R	769,00	1	024004053
RSC24/5-B	769,00	1	024004056
RSC24/5-A	769,00	1	024004057
RSC24/5-N	769,00	1	024004059



RSC24/5-O

Beta RSC24



h	max
70 mm	25 kg
140 mm	30 kg
280 mm	35 kg

RSC24/6

mobile roller cab with 6 drawers

Main features:

- 6 fully removable drawers (588x367 mm), with ball bearing slides:
- 4 drawers, 70 mm high
- 1 drawer, 140 mm high
- 1 drawer, 280 mm high

62 kg

	€		
RSC24/6-FO	835,00	1	024004060
RSC24/6-O	835,00	1	024004061
RSC24/6-G	835,00	1	024004062
RSC24/6-R	835,00	1	024004063
RSC24/6-B	835,00	1	024004066
RSC24/6-A	835,00	1	024004067
RSC24/6-N	835,00	1	024004069



RSC24/6-O

Beta RSC24



h	max
70 mm	25 kg
140 mm	30 kg
280 mm	35 kg

RSC24/8

mobile roller cab with 8 drawers

Main features:

- 8 fully removable drawers (588x367 mm), with ball bearing slides:
- 6 drawers, 70 mm high
- 2 drawers, 140 mm high

66 kg

	€		
RSC24/8-FO	978,00	1	024004080
RSC24/8-O	978,00	1	024004081
RSC24/8-G	978,00	1	024004082
RSC24/8-R	978,00	1	024004083
RSC24/8-B	978,00	1	024004086
RSC24/8-A	978,00	1	024004087
RSC24/8-N	978,00	1	024004089



RSC24/8-O

Beta RSC24



h	max
70 mm	25 kg
140 mm	30 kg

RSC24A/6

mobile roller cab with 6 drawers,
with anti-tilt system

Main features:

- 6 fully removable drawers (588x367 mm), with ball bearing slides:
- 4 drawers, 70 mm high
- 1 drawer, 140 mm high
- 1 drawer, 280 mm high

62 kg

	€	↕	📄
RSC24A/6-O	897,00	1	024004161
RSC24A/6-R	897,00	1	024004163
RSC24A/6-A	897,00	1	024004167



Beta RSC24



RSC24A/6-A



RSC24A/6-R



h	↕ max
70 mm	25 kg
140 mm	30 kg
280 mm	35 kg

RSC24A/7

mobile roller cab with 7 drawers,
with anti-tilt system

Main features:

- 7 fully removable drawers (588x367 mm), with ball bearing slides:
- 5 drawers, 70 mm high
- 1 drawer, 140 mm high
- 1 drawer, 210 mm high.

63 kg

	€	↕	📄
RSC24A/7-O	960,00	1	024004171
RSC24A/7-R	960,00	1	024004173
RSC24A/7-A	960,00	1	024004177



Beta RSC24



RSC24A/7-A



RSC24A/7-R



h	↕ max
70 mm	25 kg
140 mm	30 kg
210 mm	30 kg

RSC24A/8

mobile roller cab with 8 drawers,
with anti-tilt system

Main features:

- 8 fully removable drawers (588x367 mm), with ball bearing slides:
- 6 drawers, 70 mm high
- 2 drawers, 140 mm high

66 kg

	€	↕	📄
RSC24A/8-O	1.033,00	1	024004181
RSC24A/8-R	1.033,00	1	024004183
RSC24A/8-A	1.033,00	1	024004187



Beta RSC24



RSC24A/8-A



RSC24A/8-R



h	↕ max
70 mm	25 kg
140 mm	30 kg

MOBILE ROLLER CAB RSC24AXL



LONG VERSION:
each drawer can accommodate up to 6 EVA foam or ABS thermoformed trays

ANTI-TILT SYSTEM: PREVENTS SEVERAL DRAWERS FROM BEING SIMULTANEOUSLY OPENED



- Drawers with ball bearing slides
- New ABS reinforced worktop with anti-fall edges, eight holes for accommodating screwdrivers and 6 tote trays
- Sturdy nylon front, with built-in label holder
- Four castors Ø 125 mm: 2 fixed and 2 steering (one with brake)
- Static load capacity: 1000 kg
- Drawer bases protected by foamed rubber mats
- Integrated side bottle holder
- Front centralized safety lock

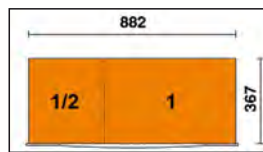
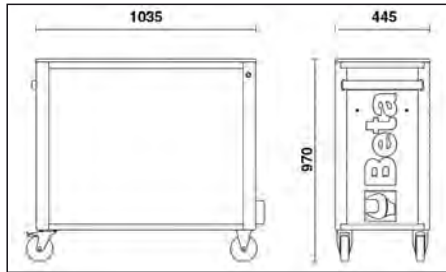

Available colours:

O	RAL 7016	RAL 2011
G	RAL 7016	RAL 7016
R	RAL 7016	RAL 3000

Available accessories:



2400 RSC24/PD-A



2400 RSC24/PL

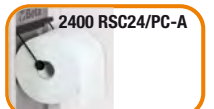

2400 RSC24/PC-A

RSC24AXL/7

mobile roller cab with 7 drawers,
with anti-tilt system,
long model

Main features:

- 7 fully removable drawers (882x367 mm), with ball bearing slides:
- 5 drawers, 70 mm high
- 1 drawer, 140 mm high
- 1 drawer, 210 mm high

84 kg



RSC24AXL/7-O

Beta RSC24



RSC24AXL/7-A



RSC24AXL/7-R

h	max
70 mm	30 kg
140 mm	35 kg
210 mm	35 kg

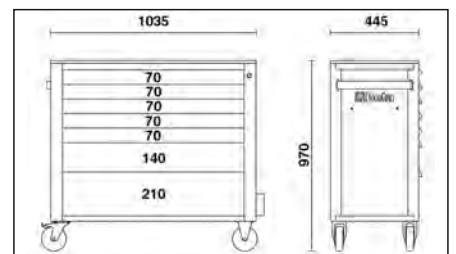
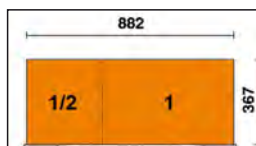

	€	1	
RSC24AXL/7-O	1.220,00	1	024004271
RSC24AXL/7-R	1.220,00	1	024004273
RSC24AXL/7-A	1.220,00	1	024004277

RSC24AXL/8

mobile roller cab with 8 drawers,
with anti-tilt system,
long model

Main features:

- 8 fully removable drawers (882x367 mm), with ball bearing slides: 6 drawers, 70 mm high. 2 drawers, 140 mm high.

88 kg

	€	📦	🚚
RSC24AXL/8-O	1.305,00	1	024004281
RSC24AXL/8-R	1.305,00	1	024004283
RSC24AXL/8-A	1.305,00	1	024004287



h	max
70 mm	30 kg
140 mm	35 kg

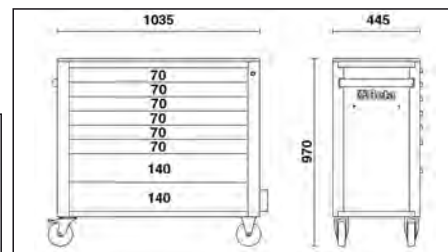

RSC24AXL/9

mobile roller cab with 9 drawers,
with anti-tilt system,
long model

Main features:

- 9 fully removable drawers (882x367 mm), with ball bearing slides: 8 drawers, 70 mm high. 1 drawer, 140 mm high.

90 kg

	€	📦	🚚
RSC24AXL/9-O	1.385,00	1	024004291
RSC24AXL/9-R	1.385,00	1	024004293
RSC24AXL/9-A	1.385,00	1	024004297



h	max
70 mm	30 kg
140 mm	35 kg

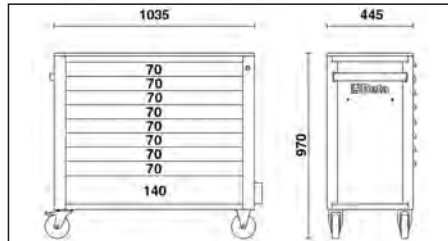
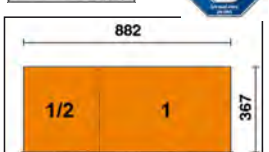

2400 RSC24/PC

paper roll holder for mobile roller cab RSC24

0,3 kg

	€		
2400 RSC24/PC-A	20,40	1	024004903
2400 RSC24/PC-N	20,40	1	024004904



- RAL7016 2400 RSC24/PC-A
- RAL9005 2400 RSC24/PC-N



2400 RSC24/PD

document holder for mobile roller cab RSC24

1,2 kg

	€		
2400 RSC24/PD-A	36,00	1	024004907
2400 RSC24/PD-N	36,00	1	024004908



- RAL7016 2400 RSC24/PD-A
- RAL9005 2400 RSC24/PD-N



2400 RSC24/PF

perforated tool panel with supports, for roller cab RSC24

2,3 kg

	€		
2400 RSC24/PF	62,00	1	024004902

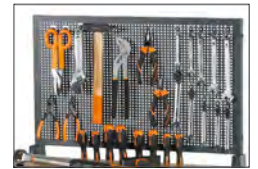

2400 RSC24/PF-

bottle holder for mobile roller cab RSC24

0,5 kg

	€		
2400 RSC24/PF-A	21,40	1	024004905
2400 RSC24/PF-N	21,40	1	024004906



- RAL7016 2400S RSC24/PF-A
- RAL9005 2400S RSC24/PF-N



2400 RSC24/PL

wood worktop for roller cab RSC24

4,3 kg

	€		
2400 RSC24/PL	77,00	1	024004901



2400 RSC24/SPC

computer bracket for mobile roller cab RSC24

- With removable drawer
- Cannot be used with model RSC24AXL

3,1 kg

	€		
2400 RSC24/SPC	117,00	1	024004909



5000MS

folding shelf for items RSC24 - RSC24A - C50S

- For use as additional worktop
- Worktop dimensions: 390x440 mm, protected by an anti-oil and anti-petrol rubber mat
- Load capacity: 20 kg.

📦 3,4 kg



5000MS	€ 56,50	📦 1	📄 050000901
--------	---------	-----	-------------

2499PF

bottle holder

- Can match roller cabs C38, C38A

📦 2,5 kg

2499PF O

2499PF G

2499PF R



2499PF-O	€ 65,50	📦 1	📄 024990210
2499PF-G	€ 65,50	📦 1	📄 024990219
2499PF-R	€ 65,50	📦 1	📄 024990230

2499PF/M

universal magnetic bottle holder

📦 2,2 kg



2499PF/M	€ 54,50	📦 1	📄 024990050
----------	---------	-----	-------------

2499PC

paper roll holder

- Matches Tank trolleys C25 and cabs C38.

📦 2,2 kg



2499PC	€ 69,00	📦 1	📄 024990090
--------	---------	-----	-------------



RSC24L/7

mobile roller cab
with 7 drawers
and side shelves

Main features:

- 7 drawers (588x367 mm)
- with ball bearing slides:
- 5 drawers, 70 mm high
- 1 drawer, 140 mm high
- 1 drawer, 210 mm high.
- Drawer bases protected by foamed rubber mats.
- 4 castors, Ø 125 mm:
- 2 fixed and 2 steering with brakes.
- Front centralized lock.
- Static load capacity: 1,100 kg.
- Multi-ply wood worktop with holes for a vice (1599F/100, to be ordered separately).
- Side compartment with vertically adjustable shelf.
- Built-in paper roll holder.
- Double rear bottle holder.

80 kg

	€	1	024004371
RSC24L/7-O	1.350,00	1	024004371
RSC24L/7-R	1.350,00	1	024004373
RSC24L/7-A	1.350,00	1	024004377

Beta RSC24

1100 kg



RSC24L/7-A



RSC24L/7-R



RSC24L/7-O

h	max
70 mm	25 kg
140 mm	30 kg
210 mm	30 kg

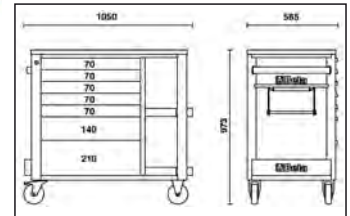
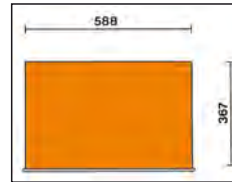

RSC24L-CAB

mobile roller cab
with 7 drawers
and tool cabinet

Main features:

- 7 drawers (588x367 mm)
- with ball bearing slides:
- 5 drawers, 70 mm high
- 1 drawer, 140 mm high
- 1 drawer, 210 mm high.
- Drawer bases protected by foamed rubber mats.
- 4 castors, Ø 125 mm:
- 2 fixed and 2 steering with brakes.
- Front centralized lock.
- Side tool cabinet with lockable door and vertically adjustable interior shelf.
- Static load capacity: 1,100 kg.
- Multi-ply wood worktop with holes for a vice (1599F/100, to be ordered separately).
- Built-in paper roll holder.
- Double rear bottle holder.

82 kg

	€	1	024004471
RSC24L-CAB/O	1.390,00	1	024004471
RSC24L-CAB/R	1.390,00	1	024004473
RSC24L-CAB/A	1.390,00	1	024004477

Beta RSC24

1100 kg



RSC24L-CAB/A



RSC24L-CAB/R



RSC24L-CAB/O

h	max
70 mm	25 kg
140 mm	30 kg
210 mm	30 kg

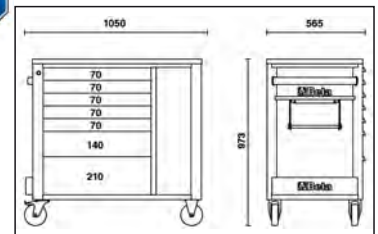
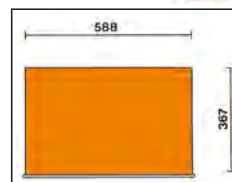

C04TSS-7

mobile roller cab with seven drawers, made entirely of stainless steel, Non-marking wheels

Main features:

- Seven drawers (570 x 410 mm) with ball bearing slides;
- 6 drawers, 83 mm high;
- 1 drawer, 170 mm high;
- 4 castors Ø 125 mm
- 2 fixed and 2 steering (two with brakes);
- Front centralized lock;
- Frame made entirely of stainless steel AISI 304
- Castors, supports, ball bearings, drawer interiors and guides made of stainless steel
- Drawer handles made of aluminium

63 kg

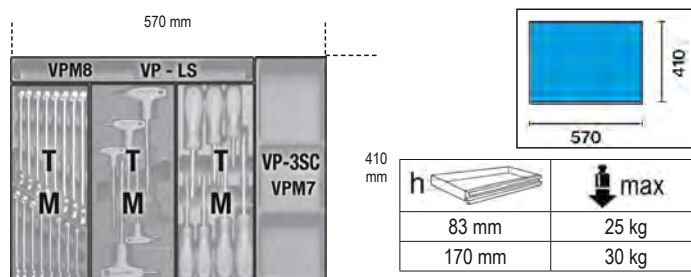

C04TSS/7 € 2.450,00 1 024003077 296

C25

Tank trolley with shelf

Main features:

- Foldaway lid.
- 1 sliding drawer.
- Tool tray protected by foamed rubber mats.
- Shelves protected by oil and fuel proof mats.
- Four castors 100 mm in ø:
- 2 fixed and 2 swivelling (one with brake).
- Safety lock.
- One more shelf M4 can be added on the opposite side.
- Empty thermoformed tray for 1/2" sockets and accessories (024990104).
- Paper roll holder item 2499PC can also be included

31,5 kg

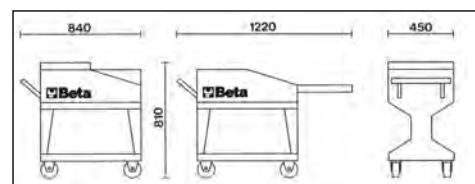

C25 € 565,00 1 025000001

C27S

folding tool trolley for outdoor jobs

Folding tool trolley. Its unique patented design guarantees an effortless transport.

- 2 drawers, 588x277 mm, with ball bearing slides for two-way opening.
- Large lower object compartment, 588x277x220 mm.
- Sheet metal frame.
- 2 fixed castors, Ø 160 mm, and 2 steering castors with brake, Ø 100 mm
- Thermoplastic worktop with 6 built-in tool trays.
- Centralized lock.
- Can accommodate drawer partitions and MC foam tool trays

20 kg



C27S-O



C27S-G



C27S-R



h	max
70 mm	20 kg

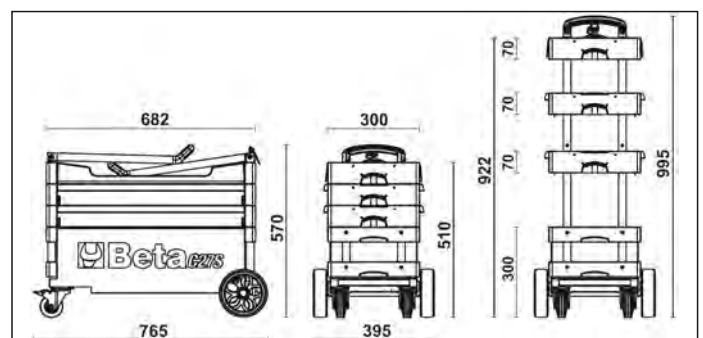
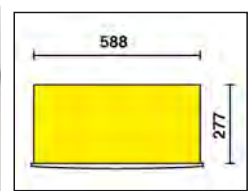

	€	1	027000201
C27S-O	633,00	1	027000201
C27S-G	633,00	1	027000202
C27S-R	633,00	1	027000203

RSC28

SuperTank trolley with wood worktop and 10 drawers

Main features:

- 10 drawers (588x367 mm) with ball bearing slides.
- Quick, safe system for opening and closing drawers, with nylon and fibreglass front.
- 5 side drawers:
 - 4 drawers, 70 mm high
 - 1 drawer, 210 mm high.
- 5 front drawers:
 - 4 drawers, 70 mm high
 - 1 drawer, 210 mm high.
- Drawer bases protected by foamed rubber mats.
- 4 high-capacity castors, Ø 150 mm:
 - 2 fixed and 2 steering with brakes.
- 2 centralized safety locks.
- 3 front tool drawers.
- Multi-ply wood worktop with holes for a vice (1599F/150, to be ordered separately).
- Built-in tool compartment.
- Side compartment with foldaway door with lock.
- Built-in bottle holders.
- 135-mm-high storage compartment with plastic-covered base.
- Static load capacity: 1,200 kg.

1200 kg



RSC28-O

130 kg



RSC28-A



RSC28-R



h	max
70 mm	25 kg
210 mm	30 kg

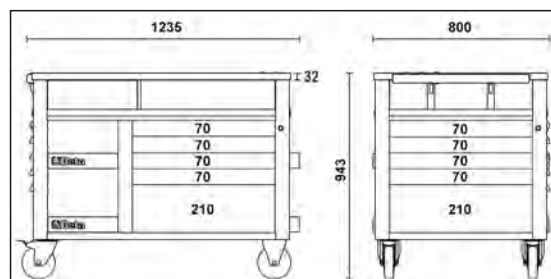
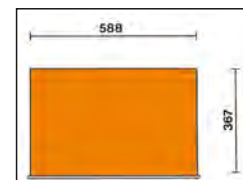

	€		
RSC28-O	2.390,00	1	028003001
RSC28-R	2.390,00	1	028003003
RSC28-A	2.390,00	1	028003007

C30M

MaxiTank mobile workbench

Main features:

- 5 front drawers with ball bearing slides:
- 3 drawers (367x610 mm), 90 mm high
- 1 drawer (588x610 mm), 90 mm high
- 1 drawer (588x610 mm), 180 mm high.
- Quick opening system with aluminium front.
- Drawer bases protected by foamed rubber mats.
- Can be fitted with thermoformed trays.
- One hydraulic jack, designed to lift front part effortlessly, thus allowing easy transportation.
- 4 high-capacity castors:
- 2 steering, front, Ø 150 mm
- 2 fixed, rear, Ø 170 mm.
- Oil-proof, rubber-coated worktop, 1300x800 mm, with drain hole for fluid collection in a small tank.
- Storage compartment, 720x250x1300 mm, with PVC-coated worktop and front sliding panels.
- Centralized lock for drawers and panels.
- 3 built-in side bottle holders.
- Built-in paper roll holder
- Static load capacity: 1,800 kg.
- Can accommodate a multi-ply wood worktop (3000M/PLM), to be ordered separately
- Can accommodate vice 1599F/150 (to be ordered separately).

1800
kg



200 kg

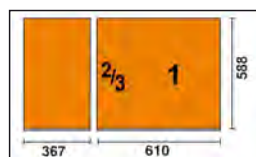

h	max
90 mm	30 kg
180 mm	35 kg

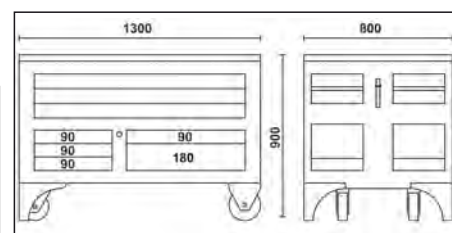

C30M

€ 3.850,00 1 030000300

3000M/PLM

wood worktop for C30M,
with holes for a vice (1599F/150)

10 kg



1240x740x26 mm

3000M/PLM

€ 417,00 1 030000350



FUNCTIONAL AND STURDY

- Pull-out drawers
- Front centralized safety lock
- Can accommodate a worktop and drawer partitions, to be ordered separately
- Static load capacity: 1200 kg

Available models:

- **C35/6** (6 drawers)
- **C35/7** (7 drawers)
- **C35/8** (8 drawers)
- **C35/9** (9 drawers)

Available accessories:

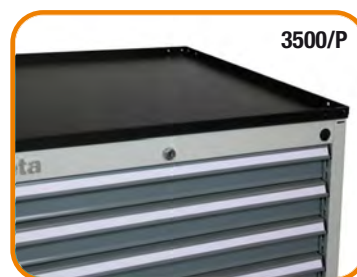

C35/6G

industrial tool chest with six drawers

Main features:

- Six pull-out drawers (600x447 mm):
 - 2 drawers, 75 mm high
 - 1 drawer, 100 mm high
 - 1 drawer, 150 mm high
 - 1 drawer, 200 mm high
 - 1 drawer, 300mm high
- Front centralized safety lock.
- Can accommodate an ABS worktop and drawer partitions, to be ordered separately.

73,5 kg



h	max
75 mm	70 kg
100 mm	70 kg
150 mm	70 kg
200 mm	70 kg
300 mm	70 kg

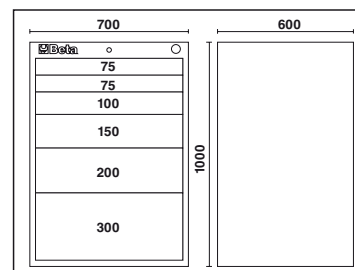
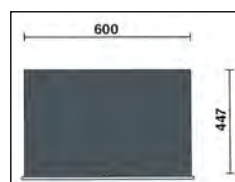

C35/6G

€ 1.280,00 1 035000062

C35/7G

industrial tool chest with seven drawers

Main features:

- Seven pull-out drawers (600x447 mm):
2 drawers, 75 mm high
1 drawer, 100 mm high
3 drawers, 150 mm high
1 drawer, 200 mm high
- Front centralized safety lock.
- Can accommodate an ABS worktop and drawer partitions, to be ordered separately.

77 kg

C35/7G € 1.335,00 1 035000072



h	max
75 mm	70 kg
100 mm	70 kg
150 mm	70 kg
200 mm	70 kg

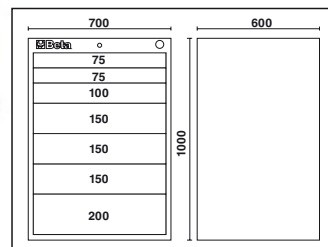
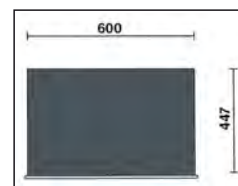

C35/8G

industrial tool chest with eight drawers

Main features:

- Eight pull-out drawers (600x447 mm):
4 drawers, 75 mm high
1 drawer, 100 mm high
2 drawers, 150 mm high
1 drawer, 200 mm high
- Front centralized safety lock.
- Can accommodate an ABS worktop and drawer partitions, to be ordered separately.

80,5 kg

C35/8G € 1.425,00 1 035000082



h	max
75 mm	70 kg
100 mm	70 kg
150 mm	70 kg
200 mm	70 kg

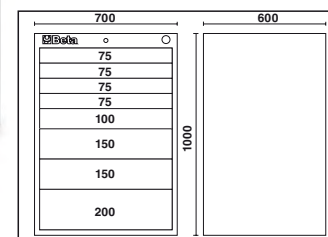

C35/9G

industrial tool chest with nine drawers

Main features:

- Nine pull-out drawers (600x447 mm):
6 drawers, 75 mm high
3 drawers, 150 mm high
- Front centralized safety lock.
- Can accommodate an ABS worktop and drawer partitions, to be ordered separately.

84 kg

C35/9G € 1.495,00 1 035000092



h	max
75 mm	70 kg
150 mm	70 kg

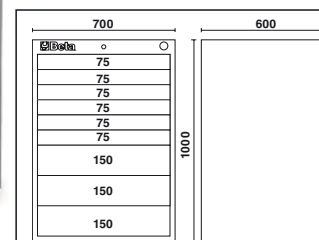

3500/P

Worktop with edge for tool chest C35

3500/P 700x600 mm € 325,00 1 035000502



MOBILE ROLLER CAB C37

SOFT BUMPERS

- Drawers with ball bearing slides
- Sturdy multi-purpose worktop
- Quick release system made of aluminium, opening throughout length of drawer
- Tote-trays and holes for accommodating screwdrivers
- Four castors Ø 125 mm: 2 fixed and 2 steering (one with brake)
- Static load capacity: 1000 kg
- Corner bumpers throughout height of roller cab, to avoid damaging vehicles in garage
- Drawer bases protected by foamed rubber mats
- Front centralized safety lock
- Built-in side bottle and paper holders, adjustable in several positions

Available models:

- C37/6 (6 drawers)
- C37/7 (7 drawers)
- C37/8 (8 drawers)
- C37A/7 (7 drawers with anti-tilt system)

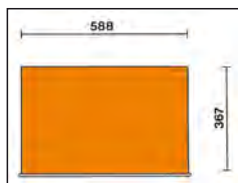

Available colours:

O	RAL 2011
G	RAL 7016
R	RAL 3000

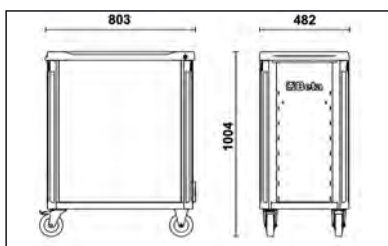

Available accessories:

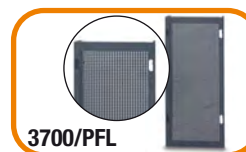

C37/7

mobile roller cab with 7 drawers

Main features:

- 7 drawers (588x367 mm) with ball bearing slides:
- 5 drawers 75 mm high
- 1 drawer 150 mm high
- 1 drawer 225 mm high

71 kg



C37/7-G



C37/7-R



h	max
75 mm	30 kg
150 mm	35 kg
225 mm	35 kg

	€		
C37/7-O	1.044,00	1	037000071
C37/7-G	1.044,00	1	037000072
C37/7-R	1.044,00	1	037000073

C37/6

mobile roller cab
with 6 drawers

Main features:

- 6 drawers (588x367 mm) with ball bearing slides:
- 4 drawers 75 mm high
- 1 drawer 150 mm high
- 1 drawer 305 mm high

69 kg

	€	1	037000061
C37/6-O	1.010,00	1	037000061
C37/6-G	1.010,00	1	037000062
C37/6-R	1.010,00	1	037000063



C37/6-G



C37/6-R



h	max
75 mm	30 kg
150 mm	35 kg
305 mm	40 kg



C37/8

mobile roller cab
with 8 drawers

Main features:

- 8 drawers (588x367 mm) with ball bearing slides:
- 6 drawers 75 mm high
- 2 drawers 150 mm high

73 kg

	€	1	037000081
C37/8-O	1.084,00	1	037000081
C37/8-G	1.084,00	1	037000082
C37/8-R	1.084,00	1	037000083



C37/8-G



C37/8-R



h	max
75 mm	30 kg



C37A/7

mobile roller cab
with 7 drawers, with anti-tilt system

Main features:

- 7 drawers (588x367 mm), with ball bearing slides:
- 5 drawers 75 mm high
- 1 drawer 150 mm high
- 1 drawer 225 mm high

71 kg

	€	1	037000271
C37A/7-O	1.073,00	1	037000271
C37A/7-G	1.073,00	1	037000272
C37A/7-R	1.073,00	1	037000273



C37/8-G



C37/8-R



h	max
75 mm	30 kg
150 mm	35 kg
225 mm	35 kg



3700/PLA

stainless steel worktop for mobile roller cab item C37

2,8 kg

3700/PLA € 62,50 1 037000100



3700/PLL

wood worktop for mobile roller cab item C37

3,9 kg

3700/PLL € 78,00 1 037000101



672x396x28 mm

3700/PF

perforated panel with brackets for mobile roller cab item C37

3,2 kg

3700/PF € 62,00 1 037000102



3700/PFL

perforated side panel for mobile roller cab item C37

1,9 kg

3700/PFL € 33,50 1 037000104

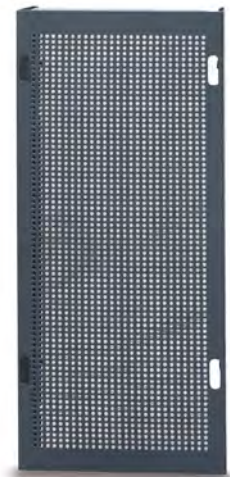

3700/PC

computer bracket for mobile roller cab item C37

3,1 kg

3700/PC € 85,00 1 037000103



C38

mobile roller cab
with eleven drawers

Main features:

- Eleven drawers with ball bearing slides:
- 1 drawer 937x410x122 mm
- 3 drawers 570x410x74 mm
- 2 drawers 570x410x153 mm
- 3 drawers 313x410x74 mm
- 2 drawers 313x410x153 mm.
- Drawer bases protected by foamed rubber mats.
- Static load capacity: 1200 kg.
- 4 high-capacity castors: Ø 125 mm:
- 2 fixed and 2 steering (both with lever brake).
- Front centralized lock.
- Sheet metal worktop covered by a rubber mat.
- Can be fitted with paper roll holder item 2499PC and bottle holder item 2499PF.

114 kg



C38-G

C38-R

C38-O



h	max
74 mm	25 kg
153 mm	30 kg

	€		
C38-O	1.655,00	1	038000001
C38-G	1.655,00	1	038000003
C38-R	1.655,00	1	038000002

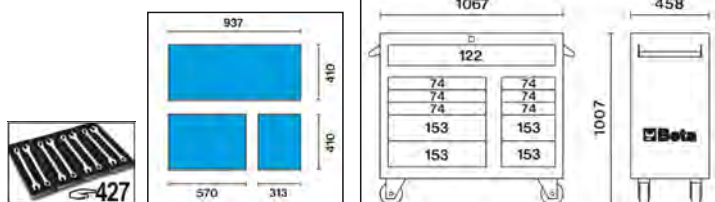

C38L

side cab with 7 drawers

Main features:

- 7 drawers (410x313 mm), with ball bearing slides:
- 5 drawers, 74 mm high 2 drawers, 153 mm high.
- Drawer bases protected by foamed rubber mats.
- Front centralized safety lock.
- Antislip aluminium worktop.
- Can be hooked to both sides of roller cab C38.

45 kg



C38L-G

C38L-O

C38L-R

h	max
74 mm	25 kg
153 mm	30 kg

	€		
C38L-O	800,00	1	038000081
C38L-G	800,00	1	038000083
C38L-R	800,00	1	038000082

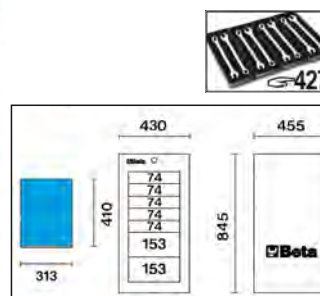

C38LA

side module with door
and interior shelf

Main features:

- Front lock.
- Vertically adjustable interior shelf.
- Document pocket inside door.
- Nonslip aluminium worktop.
- Can be hooked to both sides of mobile roller cab C38.

18 kg



C38LA-G

C38LA-O

C38LA-R

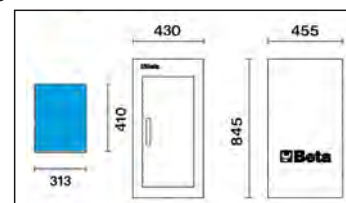

	€		
C38LA O	306,00	1	038000071
C38LA G	306,00	1	038000073
C38LA R	306,00	1	038000072

C38C

- mobile roller cab
with thirty three drawers,
comprising:
- 1 mobile roller cab C38
 - 2 side cabs C38L
 - 1 cab C38T with top chest

268 kg



C38C-O



C38C-G



C38C-R



h	max
74 mm	25 kg
153 mm	30 kg

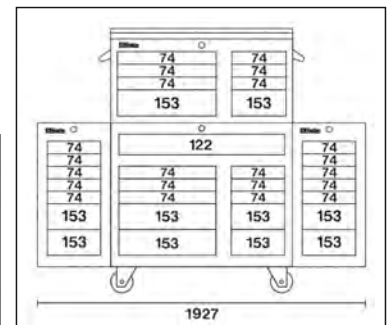
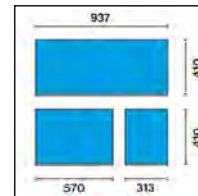

	€		
C38C-O	4.290,00	1	038000201
C38C-G	4.290,00	1	038000203
C38C-R	4.290,00	1	038000202

C38T

- top cab
with 8 drawers and tool compartment

Main features:

- 8 drawers with ball bearing slides:
3 drawers 570x410x74 mm
1 drawer 570x410x153 mm
3 drawers 313x410x74 mm
1 drawer 313x410x153 mm.
- Tool compartment.
- Drawer bases protected by foamed rubber mats.
- Front centralized safety lock.
- Can be placed on worktop or mobile roller cab C38.



C38T-O



C38T-G



C38T-R

h	max
74 mm	25 kg
153 mm	30 kg

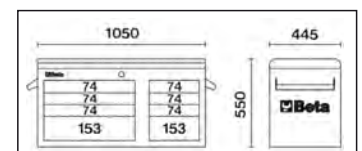
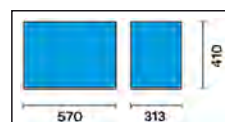

	€		
C38T-O	1.039,00	1	038000091
C38T-G	1.039,00	1	038000093
C38T-R	1.039,00	1	038000092

64 kg

MOBILE ROLLER CAB C39

UPRIGHTS AND DRAWER FRONT MADE OF ALUMINIUM ALLOY + STURDINESS + LIGHTWEIGHTNESS

- Drawers with ball bearing slides
- Thermoplastic worktop, designed to support portable tool chest C39T
- Quick release system made of aluminium, opening throughout length of drawer
- Four castors Ø 125 mm: 2 fixed and 2 steering (one with brake)
- Static load capacity: 1200 kg
- Drawer bases protected by foamed rubber mats
- Front centralized safety lock
- Tote-trays and holes for accommodating screwdrivers
- Integrated side and rear bottle holders
- Integrated paper roll holder

Available models:

- C39/6 (6 drawers)
- C39/7 (7 drawers)
- C39/8 (8 drawers)

Available colours:

	
O	RAL 2011
G	RAL 7016
R	RAL 3000

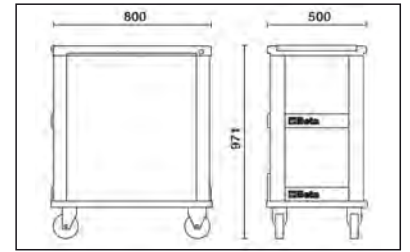
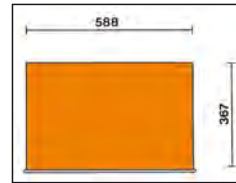

C39/7

roller cab
with seven drawers

Main features:

- Seven drawers (588x367 mm) with ball bearing slides:
5 drawers, 70 mm high
1 drawer, 140 mm high
1 drawer, 210 mm high.

61 kg

1200 kg



C39-7/G



C39-7/R

C39-7/O

	€	📦	🖨️
C39-7/O	1.550,00	1	039000001
C39-7/G	1.550,00	1	039000002
C39-7/R	1.550,00	1	039000003

h	max
70 mm	30 kg
140 mm	35 kg
210 mm	35 kg



C39/6

mobile roller cab with six drawers

Main features:

- Six drawers (588x367 mm) with ball bearing slides:
 - 4 drawers, 70 mm high
 - 1 drawer, 140 mm high
 - 1 drawer, 280 mm high

59 kg

	€	🛒	📄
C39-6/O	1.465,00	1	039000031
C39-6/G	1.465,00	1	039000032
C39-6/R	1.465,00	1	039000033



C39-6/G



C39-6/R



h	max
70 mm	30 kg
140 mm	35 kg
280 mm	40 kg



C39/8

mobile roller cab with eight drawers

Main features:

- Eight drawers (588x367 mm) with ball bearing slides:
 - 6 drawers, 70 mm high
 - 2 drawers, 140 mm high

64 kg

	€	🛒	📄
C39-8/O	1.655,00	1	039000041
C39-8/G	1.655,00	1	039000042
C39-8/R	1.655,00	1	039000043



C39-8/G



C39-8/R



h	max
70 mm	30 kg



C39T

portable tool chest with four drawers

Main features:

- Four drawers (588x367 mm) with ball bearing slides:
 - 4 drawers, 70 mm high
- Front centralized safety lock.
- Uprights and drawer front made of aluminium.

29 kg

	€	🛒	📄
C39T-O	993,00	1	039000101
C39T-G	993,00	1	039000102
C39T-R	993,00	1	039000103



C39T-O



C39T-R



C39T-G



29 kg

h	max
70 mm	30 kg

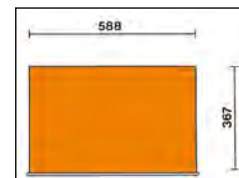
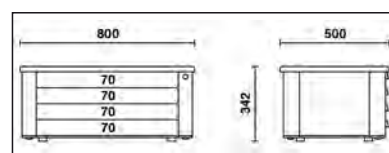

2200-COVER RSC22

nylon cover for portable tool chest RSC22



2200-COVER RSC22 € 17,10 1 022000910

2300-COVER RSC23

nylon cover for portable tool chest RSC23



2300-COVER RSC23 € 18,20 1 023000920

2300-COVER RSC23T

nylon cover for portable tool chest RSC23T



2300-COVER RSC23T € 20,00 1 023000930

2400-COVER RSC24

nylon cover for mobile roller cabs RSC24 - C39



2400-COVER RSC24 € 20,50 1 024000910

2400-COVER RSC24AXL

nylon cover for mobile roller cabs RSC24AXL, RSC24L, RSC24L-CAB



2400-COVER RSC24AXL € 28,00 1 024000930

3700-COVER C37

Nylon cover for mobile roller cab item C37



3700-COVER C37 € 27,50 1 037000930

4100-COVER C41H

nylon cover for tool trolley item C41H



4100-COVER C41H € 21,50 1 041000930

C39SM

special mobile roller cab, Racing SM type

Specifications

- Multi-ply wood worktop
- 4 castors, Ø 125 mm
- 2 fixed and 2 steering (one with brake), with exposed covering
- Static load capacity: 1200 kg

7-drawer module

588x367 mm, with ball bearing slides:

6 drawers, 70 mm high

1 drawer, 240 mm high

- Drawer bases protected by foamed rubber mats

- Front centralized safety lock

- Opening system throughout length of drawer

- Drawer front made of aluminium

Service module

- Integrated wastepaper basket

- Paper roll compartment

- 1 large drawer (420x305x270 mm)



125 kg

	€	📦	🚚
C39SM-O	2.530,00	1	039390001
C39SM-G	2.530,00	1	039390002
C39SM-R	2.530,00	1	039390003

C39MD

special mobile roller cab, Racing MD type

Specifications

- Multi-ply wood worktop
- 4 castors, Ø 125 mm
- 2 fixed and 2 steering (one with brake), with exposed covering
- Static load capacity: 1200 kg

7-drawer module

588x367 mm, with ball bearing slides:

6 drawers, 70 mm high

1 drawer, 240 mm high

- Drawer bases protected by foamed rubber mats

- Front centralized safety lock

- Opening system throughout length of drawer

- Drawer front made of aluminium

2-drawer module

588x367x270 mm and 588x367x380 mm, with ball bearing slides

- Drawer bases protected by foamed rubber mats

- Front centralized lock

- Opening system throughout length of drawers

- Drawer front made of aluminium



123 kg

	€	📦	🚚
C39MD-O	2.610,00	1	039390101
C39MD-G	2.610,00	1	039390102
C39MD-R	2.610,00	1	039390103

C41S

two-module tool trolley

Main features:

- Sheet metal frame and plastic tops, synonymous with remarkable sturdiness and reduced weight.
- 2 detachable modules:
 - 1 upper tool box,
 - 1 module with 2 drawers, 95 mm and 295 mm high respectively.
- Oversized castors (160 mm), built into frame for easy transport - for example, on steps.
- Side centralized lock for closing drawers of lower module.
- Drawers with ball bearing slides and double closing hook.
- Telescopic aluminium handle.
- Small tool holder built into upper tool box.
- Lower drawer with double ballbearing slide

Recommended assortments: 5940/SBK and 5915VU/5

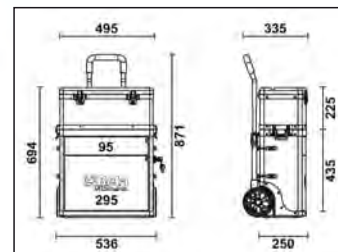
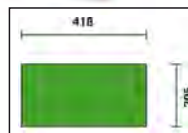

16 kg

C41S € 471,00 1 041000001

C41H

two-module tool trolley

Main features:

- Sheet metal frame and plastic tops, synonymous with remarkable sturdiness and reduced weight.
- 2 detachable modules:
 - 1 upper tool box,
 - 1 module with 2 drawers 95 mm in height,
 - 1 pull-out case made of plastic, 66 mm high, and 1 drawer 295 mm in height.
- Oversized castors (160 mm), built into frame for easy transport - for example, on steps.
- Side centralized lock for closing drawers of lower module.
- Drawers with ball bearing slides and double closing hook.
- Telescopic aluminium handle.
- Small tool holder built into upper tool box.
- Lower drawer with double ballbearing slide

Recommended assortments: 5941VU/M, 5940/SBK and 5915VU/5

* Colours available on request



C41H-O



C41H-W

C41H-Y

C41H-R

C41H-V

C41H-B

C41H-G

C41H-N

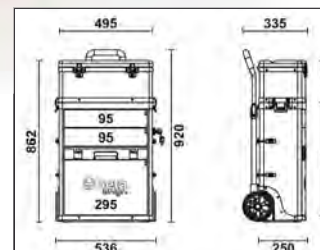
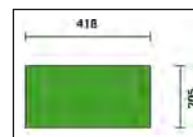

21 kg

Model	RAL	Price (€)	Qty	Code
C41H-O	RAL 2011	532,00	1	041000002
C41H-N	RAL 9005	532,00	1	041000005
C41H-B	RAL 5002	532,00	1	041000006
C41H-R	RAL 3000	532,00	1	041000008
C41H-G	RAL 7016	532,00	1	041000010
C41H-Y	RAL 1023	532,00	1	041000012
C41H-W	RAL 9016	532,00	1	041000021
C41H-V	RAL 6016	532,00	1	041000024

C41H/CE

tool chest
with removable partitions for small tools,
made from plastic material

1,3 kg

C41H/CE € 32,00 1 041000916



C42H

three-module tool trolley

Main features:

- Sheet metal frame and plastic tops, synonymous with remarkable sturdiness and reduced weight.
- 3 detachable modules:
 - 1 upper tool box, 220 mm high
 - 1 central tool module, 180 mm high.
 - 1 lower tool module with castors, 330 mm high.
- Oversized castors (ø 160 mm).
- Telescopic handle, can be adjusted in 3 positions
- Quick module release system: easy, quick access to all tool compartments.
- Upper tool box with interior object compartment and 3 tool trays built into cover.
- Can be used with 2 modules.

Recommended assortments: 5940/SBK and 5915VU/5

14 kg

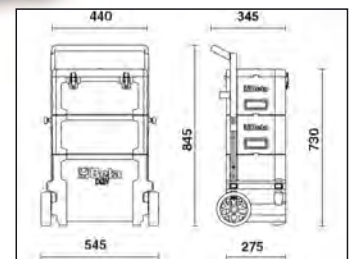

C42H

€ 379,00 1 042000002

C43

three-module tool trolley

Main features:

- Sheet metal frames and plastic tops
- 3 detachable modules:
 - 1 upper tool box, 222 mm high
 - 1 central module, 168 mm high, with 2 drawers, 60 mm high
 - 1 lower module, 332 mm high, with up-and-over door, 280 mm high, with castors
- Castors ø 128 mm
- Telescopic handle, can be adjusted in 4 positions
- Module release system with access to all tool compartments
- Upper tool box with removable interior object compartment and 2 tote-trays built into cover

15,5 kg

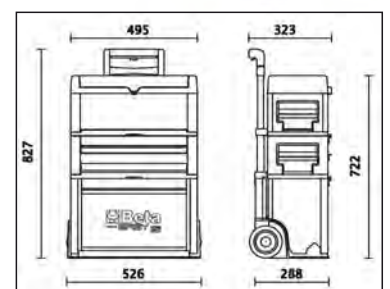
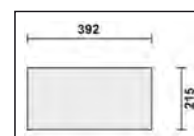

C43

€ 299,00 1 043000003

CX49-G

multi-purpose trolley

can be used as a mobile workstation for diagnostic tools, laptops, testers and battery chargers.

Specifications:

- Painted sheet metal frame: unparalleled firmness and sturdiness
- Ergonomic handle
- 2-level top
- Pull-out drawer for housing a mini keyboard
- 2 central shelves with adjustable position and 1 fixed low shelf
- 4 useful side cable reels made of plastic - 2 useful side containers
- 2 fixed rear castors Ø 160 mm
- 2 steering front castors Ø 100 mm (one with brake)
- Weight: 43 kg



CX49

€ 647,00



1



049000102

CA49-G

multi-purpose trolley with door

can be used as a mobile workstation for diagnostic tools, laptops, testers and battery chargers.

Specifications:

- Painted sheet metal frame: unparalleled firmness and sturdiness
- Ergonomic handle
- 2-level top
- Pull-out drawer for housing a mini keyboard
- 1 shelf with adjustable position, 1 fixed shelf and door
- 4 useful side cable reels made of plastic
- 2 useful side containers
- 2 fixed rear castors Ø 160 mm
- 2 steering front castors Ø 100 mm (one with frame)
- Weight: 36.5 kg



CA49 G

€ 727,00



1



049000112

4900-COVER C49

nylon cover for multi-purpose tool trolley item C49



4900-COVER C49

€ 30,50



1



049000930

C48M

electric platform cart, with panels

Compact dimensions and versatile use make the C48M platform cart the ideal solution for handling heavy loads (boxes, containers, bulky objects, parts of equipment) in the power-assisted mode in complete safety, including in hardly accessible areas and in work environments which cannot be accessed via conventional forklift trucks. This results in significantly reduced hazards for operators - e.g. musculoskeletal disorders caused by manual handling of loads.

Motorized platform, with 24V - 400W motor with 2x12V 33Ah battery supply and Curtis control card. Loading floor made from sturdy steel, coated with non-slip rubber, with round tubular panels preventing objects from falling during transport. The panels can be removed, to cater to individual transportation requirements.

The control console is equipped with the following:

- ignition key
- speed adjusting knob
- side butterfly handles for traction control
- intermittent beep, which is activated when moving in reverse
- battery charge indicator
- electric brake cut-out button
- emergency mushroom head button.

Fitted with 2 pneumatic traction wheels (Ø 260 mm) and 2 swivelling rubber wheels (Ø 150mm), electromagnetic brake and differential gear. Supplied with an external battery charger, 220V/50Hz - V/A 24/12

FUNCTIONAL SPECIFICATIONS

- Carrying capacity: 400 kg
- Driving speed: 4-6 km/h (adjustable)
- Battery life: 4 hours
- Maximum permitted slope with a full load: 6%
- Maximum permitted slope with 100 kg load: 18%

Safety devices:

- Electronic brake
- Buzzer
- Anti-crushing guard
- Battery charge indicator
- Curtis control cart

TECHNICAL SPECIFICATIONS

- Overall dimensions: 1280x630x1100h mm
- Useful dimensions of loading platform with panels: 1150x570 mm
- Useful dimensions of loading platform without panels: 1260x620 mm
- Height of loading platform from floor: 320 mm
- Height of battery compartment from floor: 65 mm
- Weight with batteries: 140 kg

140 kg

C48M

€ 2.560,00



1



048000230

Beta
BRUTUS

CE

400
kg



1100
630
1280



C48P

folding tool trolley

Main features:

- Loading platform made of reinforced polypropylene (PP), with non-slip coating and TPV inserts for corner protection
- Retractable handle for quick, compact storage
- Four non-marking castors, Ø 125 mm: 2 fixed and 2 steering with brakes
- Maximum capacity: 300 kg.
- Loading platform working width: 705 mm
- Loading platform depth: 480 mm
- Loading platform height: 200 mm



300
kg



11 kg

C48P

€ 240,50



1



048000030

C51

trolley

- 3 tops covered in antislip ribbed rubber
- Ergonomic handle
- Two fixing options for central worktop
- Four castors Ø 100 mm:
2 fixed and 2 steering (1 with brake)
- Static load capacity: 200 kg (distributed between 3 shelves)

21 kg

	€		
C51 O	246,50	1	051000001
C51 G	246,50	1	051000002
C51 R	246,50	1	051000003

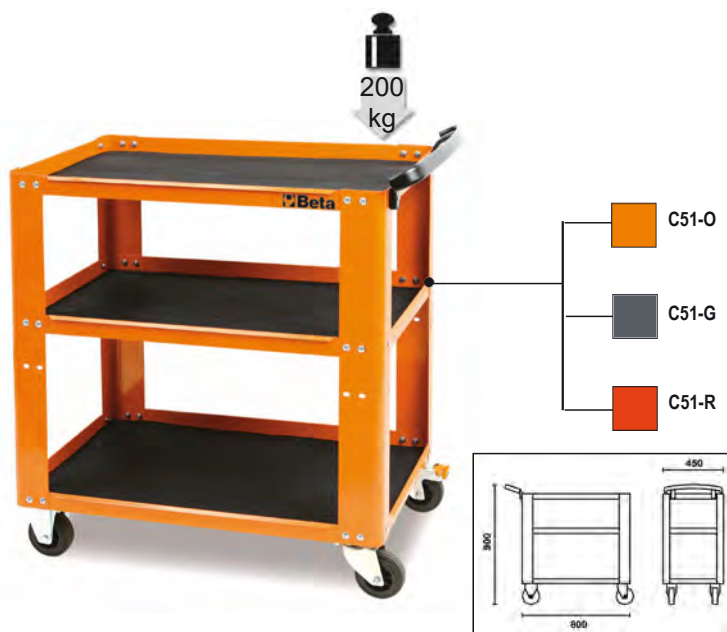

C50S

service tool trolley with 3 drawers

Main features:

- Thermoplastic worktop
- 3 drawers (588x367 mm) with ball bearing slides, 70 mm high
- Drawer bases protected by foamed rubber mats
- Front centralized safety lock
- Convenient side screwdriver holder included
- Two side built-in spray can holders
- Large lower shelf protected by an anti-oil and anti-rubber mat
- Four castors, Ø 125 mm:
2 fixed and 2 steering (one with brake)
- Static load capacity: 400 kg
- Capacity of each drawer: 15 kg, uniformly distributed
- Paper roll holder item 2400 RSC24/PC-A can be applied on request
- Folding shelf item 5000MS can be applied on request

38 kg

	€		
C50S-O	489,00	1	050000301
C50S-G	489,00	1	050000302
C50S-R	489,00	1	050000303



5000MS

folding shelf for items RSC24 - RSC24A - C50S

- For use as additional worktop
- Worktop dimensions: 390x440 mm, protected by an anti-oil and anti-petrol rubber mat
- Load capacity: 20 kg.

3,4 kg

	€		
5000MS	56,50	1	050000901

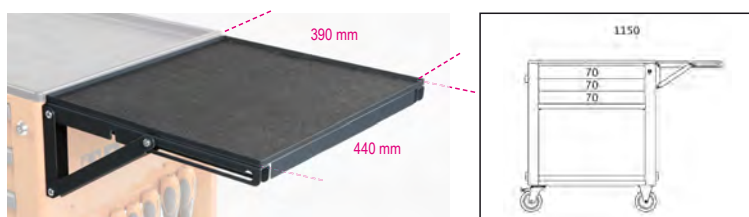

CP51

high-grade trolley

- 2 tops covered with rubber mats
- Ergonomic handle
- Four high-grade castors Ø 125 mm:
2 fixed and 2 steering with brake
- Static load capacity: 750 kg (shared by 2 tops)

37 kg

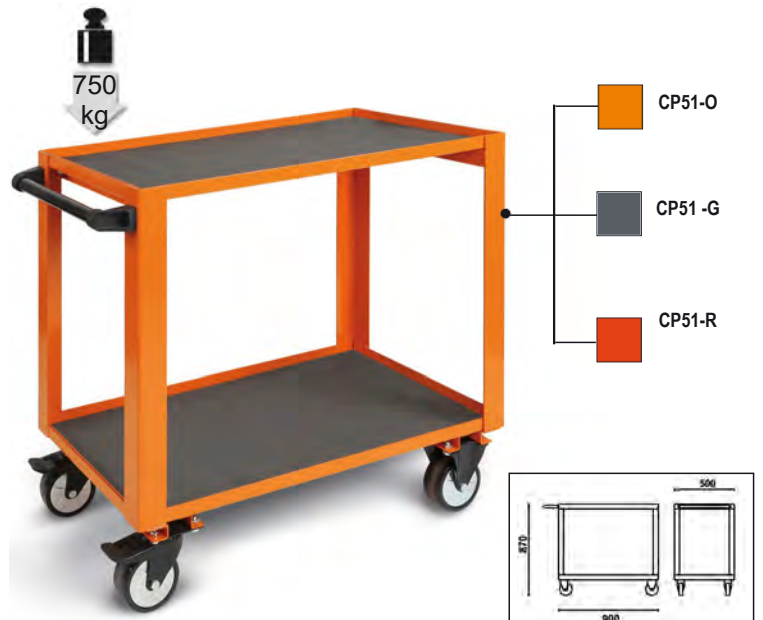

	€		
CP51 O	324,00	1	051000501
CP51 G	324,00	1	051000502
CP51 R	324,00	1	051000503

CB52

gearbox/transmission trolley
with liquid recovery system

Inclined plane and drain holes
allow liquids to be recovered in collection tank

Fitted with:

- 4 swivel castors, including 2 with brakes
- Tool drawer
- Pull-out liquid collection tank; capacity: 7 l
- 2 shelves

Features:

- Dimensions: 1200x640x870 mm
- Weight: 60 kg

60 kg



	€		
CB52	613,00	1	052000201

 **Beta**

C56P O

folding workbench

Compact and easy to carry.

Worktop (800x500mm, 30 mm thick) made of MDF and galvanized sheet iron, for use on both sides.

Handle with rubber cover, for easy transportation.

Feet with nonslip cover.

Static load capacity: 250 kg

📦 25 kg

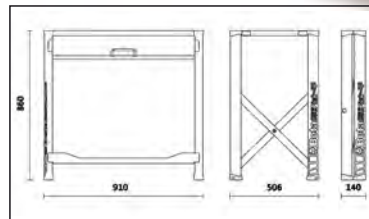

C56P O

€ 392,00 1 056000011

C56PL O

folding workbench, Light version

Lightweight, compact, easy to carry.

Worktop (800x500mm) made galvanized sheet iron, for use on one side, protected by an anti-oil and anti-petrol rubber cover.

Handle with rubber cover, for easy transportation.

Feet with nonslip cover.

Static load capacity: 200 kg

📦 18,5 kg

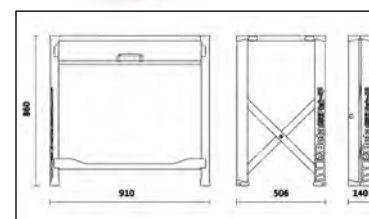

C56PL O

€ 339,00 1 056000021

C54S

Cargo tool cabinets

These tool cabinets are designed according to detailed research and offer accurate, comfortable and rational solutions for end users.

Two perforated panels attached to the doors may be opened giving access to additional storage space.

Main features:

- 1 drawer, with slides.
- Easy tool layout according to users' needs.
- Easy wall mounting by means of two slots located at the back of the cabinet .
- Safety lock for both drawers and doors.
- Empty thermoformed tray for 1/2" sockets and accessories

37 kg



C54S-G



C54S-R



C54S-O

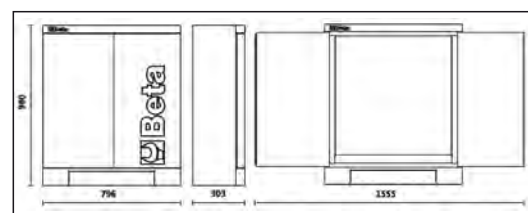

C54S-O	€ 623,00	1	054000301
C54S-G	€ 623,00	1	054000302
C54S-R	€ 623,00	1	054000303

Beta

C57SA

MasterCargo workbench

- Model with tool storage board (C57P) and one drawer cabinet.

Drawer cabinet: five drawers, 588x367 mm, 3 90 mm high, 1 180 mm and 1 280 mm high, with ball bearing slides. Can accommodate thermoformed trays. Centralized lock.

Panel tool holder with holes on back for wall mounting. Vertically operated aluminium shutter, with lock. Three removable perforated panels for supporting tools.

Multi-ply worktop, coated in plastic laminate with three holes for vice item 1599F/150, to be ordered separately.



1800 kg

C57S/A-O

205 kg



C57S/A-G



C57S/A-R



h	max
90 mm	30 kg
180 mm	40 kg
280 mm	40 kg

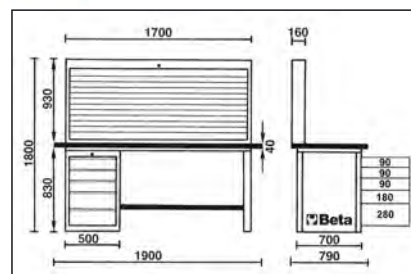

	€		
C57S/A-O	4.220,00	1	057001005
C57S/A-G	4.220,00	1	057001205
C57S/A-R	4.220,00	1	057001405

C57SD

MasterCargo workbench

- Model with one drawer cabinet

Drawer cabinet: five drawers, 588x367 mm, 3 90 mm high, 1 180 mm and 1 280 mm high, with ball bearing slides. Can accommodate thermoformed trays. Centralized lock.

Multi-ply worktop, coated in plastic laminate with three holes for vice item 1599F/150, to be ordered separately.



1800 kg

C57S/D-O



h	max
90 mm	30 kg
180 mm	40 kg
280 mm	40 kg



C57S/D-G



C57S/D-R

	€		
C57S/D-O	3.000,00	1	057001004
C57S/D-G	3.000,00	1	057001204
C57S/D-R	3.000,00	1	057001404

C57SB

MasterCargo workbench

- Model with tool storage board (C57P) and two drawer cabinets.

Drawer cabinet: five drawers, 588x367 mm, 3 90 mm high 1 180 mm and 1 280 mm high, with ball bearing slides. Can accommodate thermoformed trays Centralized lock.

Panel tool holder with holes on back for wall mounting. Vertically operated aluminium shutter, with lock. Three removable perforated panels for supporting tools.

Multi-ply wood worktop, coated in plastic laminate with three holes for vice item 1599F/150, to be ordered separately.



C57S/B-O



C57S/B-G



C57S/B-R



243 kg

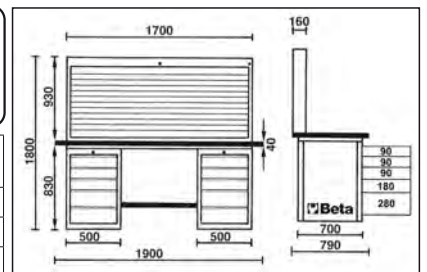

h	max
90 mm	30 kg
180 mm	40 kg
280 mm	40 kg

	€	1	057001006
C57S/B-O	5.260,00	1	057001006
C57S/B-G	5.260,00	1	057001206
C57S/B-R	5.260,00	1	057001406

C57SC

MasterCargo workbench

- Model with two drawer cabinets.

Drawer cabinet: five drawers, 588x367 mm, 3 90 mm high 1 180 mm and 1 280 mm high, with ball bearing slides. Can accommodate thermoformed trays. Centralized lock.

Multi-ply wood worktop, coated in plastic laminate with three holes for vice item 1599F/150, to be ordered separately.



C57S/C-O



h	max
90 mm	30 kg
180 mm	40 kg
280 mm	40 kg

196 kg

	€	1	057001003
C57S/C-O	4.040,00	1	057001003
C57S/C-G	4.040,00	1	057001203
C57S/C-R	4.040,00	1	057001403



C57S/C-G



C57S/C-R

C57SP

panel tool holder

Panel tool holder with two holes on back for wall mounting.
Aluminium shutter, vertically adjustable, with lock.
Three removable perforated panels for tool holding.

46 kg

C57SP-O	1.220,00	1	057001020
C57SP-G	1.220,00	1	057001220
C57SP-R	1.220,00	1	057001420



C57SP G

C57SP R

5700LAMP

MasterCargo workbench lamp

- Sturdy sheet metal frame comprising four elements; provided with screws for assembling the lamp.
- Lamp holder with 1120-Lumen LED strip, 4000K, 14W.
- Power supply 230V.
- Provided without wire.

9 kg

5700LAMP	284,00	1	057000005
----------	--------	---	-----------



5700LAMP + C57S/A-O

C58P

panel tool holder

- Security locked shutter made of painted aluminium.
- Two removable perforated panels for tool holding.

46,8 kg

C58P-O	917,00	1	058000221
C58P-G	917,00	1	058000222
C58P-R	917,00	1	058000223



C58P-G



C58P-R



1360 mm

C58P-O

PV

wall tool panel

	LxA mm		€		
PV1	1000x920	10,2	163,50	1	088880010
PV1,5	1500x920	14,2	216,00	1	088880015



C56W

workbench with wood top

- Multi-ply wood worktop with holes for a vice (1599F/125, to be ordered separately).
- Steel frame with 6 supporting legs
- Static load capacity: 1,200 kg
- Matches panel tool holder C57P; cannot be fixed to worktop.
- Two drawers with locks.
- Can be fixed to floor.

86 kg



	€	📦	🏠
C56W-O	1.046,00	1	056000251
C56W-G	1.046,00	1	056000252
C56W-R	1.046,00	1	056000253

C56B

workbench with wood top

Main features:

- Multi-ply wood worktop with holes for a vice (1599F/125, to be ordered separately).
- Steel frame with 4 supporting legs.
- Static load capacity: 800 kg.
- Lower object shelf.
- Can be fixed to floor.

54,5 kg



	€	📦	🏠
C56B-O	585,00	1	056000401
C56B-G	585,00	1	056000402
C56B-R	585,00	1	056000403

C56

workbench

- Worktop made of painted sheet metal with external edge
- Steel frame with 6 supporting legs
- Static load capacity: 1200 kg
- Matches panel toolholder C57P; cannot be fixed to worktop
- Two drawers with lock
- Can be fixed to floor

82 kg



	€	📦	🏠
C56-O	880,00	1	056000201
C56-G	880,00	1	056000202
C56-R	880,00	1	056000203

C56M

workbench

- Worktop made from both slip-proof aluminium sheet and rubber mat.
- Load capacity: kg.800.
- Can match panel toolholder C57P.
- Three drawers with lock.
- Can be fixed to the floor.

📦 95 kg



	€	📦	🖨️
C56M O	1.270,00	1	056000050
C56M G	1.270,00	1	056000053
C56M R	1.270,00	1	056000054

C58B

workbench with wood top

Main features:

- Multi-ply wood worktop with holes for a vice (1599F/125, to be ordered separately).
- Steel frame with 4 supporting legs.
- Static load capacity: 800 kg.
- Lower object shelf.
- Can be fixed to floor.

📦 44 kg



	€	📦	🖨️
C58B-O	533,00	1	058000401
C58B-G	533,00	1	058000402
C58B-R	533,00	1	058000403

C58M

workbench

- Metal worktop fully covered with a removable antislip rubber mat.
- Lower shelf made from solid wood.
- Static load capacity: 800 kg.
- Matches panel tool holder C58P; cannot be fixed to worktop.
- 2 drawers with locks.
- Can be fixed to floor.
- Aluminium worktop C58M/PA available on request.

📦 65 kg



	€	📦	🖨️
C58M-O	818,00	1	058000300
C58M-G	818,00	1	058000302
C58M-R	818,00	1	058000303

C58M/PA

knurled aluminium worktop
for workbench item C58M

4,5 kg

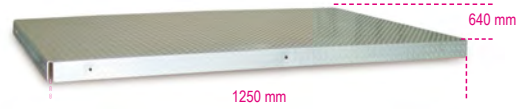

C58M/PA

€ 324,00 1 058000350

C59A

"Endurance" workbench with 1 cab with six drawers

Main features:

- Worktop made from multi-ply wood with holes for vice item 1599F/125 (to be ordered separately).
- 6 drawers (588x367 mm) with ball bearing slides:
 - 4 drawers, 70 mm high
 - 1 drawer, 140 mm high
 - 1 drawer, 280 mm high.
- Drawers protected by foamed rubber mats.
- Hard-wearing nylon drawer front.
- Roller cabs can accommodate thermoformed trays.
- Front centralized safety lock.
- Lower object shelf.
- Can be fitted with paper roll holder (2400 RSC24/PC) and bottle holder (2400 RSC24/PF-), to be ordered separately.

115 kg

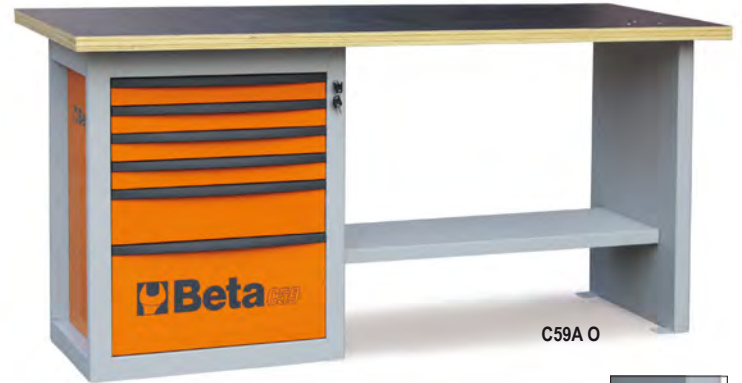

C59A O



C59A G



C59A R



1500 kg

h	max
70 mm	25 kg
140 mm	30 kg
280 mm	35 kg

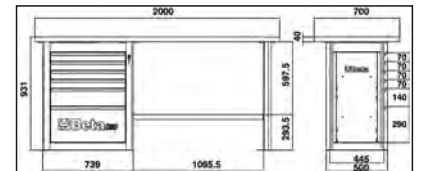

	€		
C59A-O	1.545,00	1	059000001
C59A-G	1.545,00	1	059000021
C59A-R	1.545,00	1	059000041

Beta

C59B

"Endurance" workbench with 2 cabs with six drawers

Main features:

- Worktop made from multi-ply wood with holes for vice item 1599F/125 (to be ordered separately).
- 12 drawers (588x367 mm) with ball bearing slides:
 - 8 drawers, 70 mm high
 - 2 drawers, 140 mm high
 - 2 drawers, 280 mm high.
- Drawers protected by foamed rubber mats.
- Can accommodate thermoformed trays.
- Front centralized safety lock.
- Lower object shelf.
- Can be fitted with paper roll holder (2400 RSC24/PC) and bottle holder (2400 RSC24/PF-), to be ordered separately.

1500
kg



C59B O



C59B G



C59B R

155 kg

	€	1	059000002
C59B-O	2.055,00	1	059000002
C59B-G	2.055,00	1	059000022
C59B-R	2.055,00	1	059000042

h	max
70 mm	25 kg
140 mm	30 kg
280 mm	35 kg

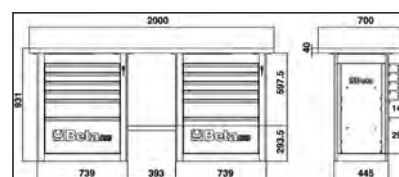

C59C

"Endurance" workbench with 1 cab with six drawers, short model

Main features:

- Worktop made from multi-ply wood with holes for vice item 1599F/125 (to be ordered separately).
- 6 drawers (588x367 mm) with ball bearing slides:
 - 4 drawers, 70 mm high
 - 1 drawer, 140 mm high
 - 1 drawer, 280 mm high.
- Drawers protected by foamed rubber mats.
- Can accommodate thermoformed trays.
- Front centralized safety lock.
- Lower object shelf.
- Can be fitted with paper roller holder (2400 RSC24/PC) and bottle holder (2400 RSC24/PF-), to be ordered separately.

1500
kg



C59C G



C59C R



C59C O



105 kg

	€	1	059000003
C59C-O	1.395,00	1	059000003
C59C-G	1.395,00	1	059000023
C59C-R	1.395,00	1	059000043

h	max
70 mm	25 kg
140 mm	30 kg
280 mm	35 kg

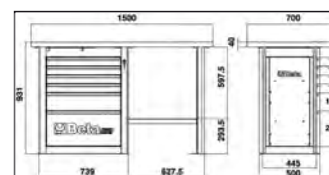

9562T2

workbench mat, 200x160 cm

- protects floor from oil and petrol leaks, environmentally friendly
- easy to clean, anti-skid, rubber-coated bottom



	€	1	095620200
9562T2	218,00	1	095620200



WORKSHOP EQUIPMENT



To answer the requirements of a market where the emphasis is increasingly on quality, design and customization, Beta Utensili has developed "Racing System C55", modular garage furniture shaped on your needs, while allowing you to create a modern work environment.

Quality

Beta's best Italian-made quality to furnish your garage

Organization

A sensibly organized workstation, synonymous with optimized work

Modularity

Modular garage fitting your spaces and requirements



Design

Refined, captivating finishes for a tidy, attractive workstation

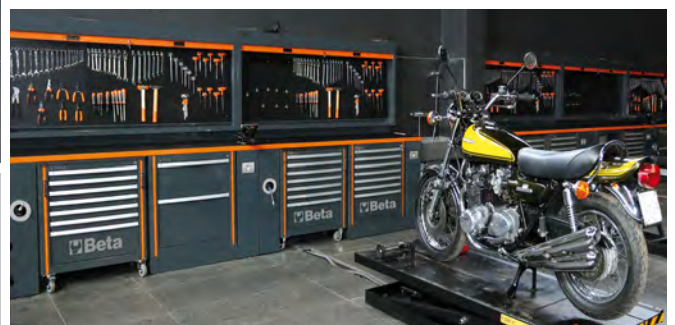



MADE IN ITALY

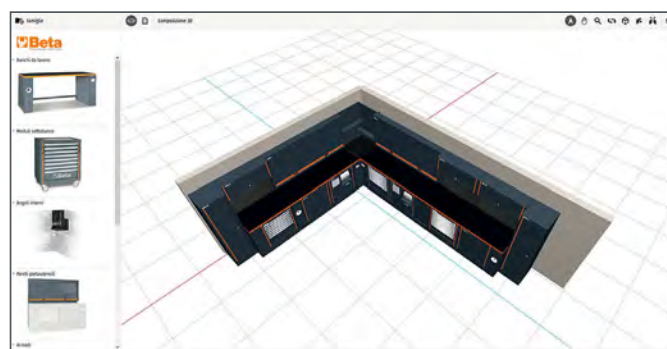

Configure your workshop online
Go to **www.rsc55.com**



Your colours for your workshop!

RSC55 allows you to order the benches and tool wall system with shutter in a neutral (grey) version and customize the vertical coloured inserts by choosing from 7 different adhesive tapes.

1. Order the vertical insert in a neutral colour

2. Order the vertical insert

Choose the colour to your taste or according to your company's colours

C55

comprehensive workshop equipment combination RSC55



Comprehensive combination comprising:

- Single-door tool cabinet (C55A1)
- Two-door tool cabinet (C55A2)
- Workbench (C55BO/2)
- Workbench with sockets (C55PRO BO/2)
- Mobile roller cab with 7 drawers (C55C7)
- Fixed module with 2 storage drawers (C55M2)
- Fixed module with 7 drawers (C55M7)
- Fixed service module (C55MS)
- Tool panel with suspended cabinets (C55/2PM)
- Tool panel with shutter (C55PS-O)

C55AB

workshop equipment combination

Combination comprising:

- Two-door tool cabinet (C55A2)
- Workbench (C55BO/2)
- Fixed module with 7 drawers (C55M7)
- Fixed service module (C55MS)
- Tool panel with suspended cabinets (C55/2PM)

407 kg



C55AB

€ 7.830,00 1 055000020



C55PB/3

workshop equipment combination

Combination comprising:

- Workbench (C55BO/2)
- Roller cab module with 8 drawers (C55C8)
- Fixed module with 2 storage drawers (C55M2)
- Wall tool system with shutter (C55PS-O)

334 kg



C55PB/3

€ 6.600,00 1 055000035



C55B/2

2-m-long workbench, for workshop equipment combination

With worktop (2050x700 mm) covered with a shockproof, non-scratch PVC coat, resistant to hydrocarbons

- Holes for a vice (1599F/150, to be ordered separately)
- Vertically adjustable feet

105 kg

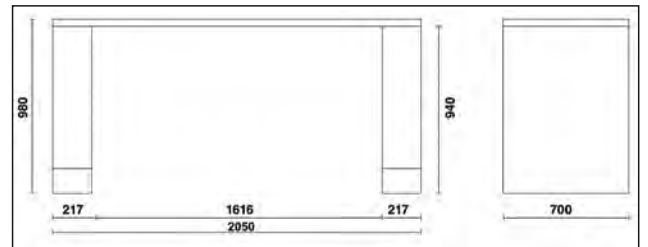
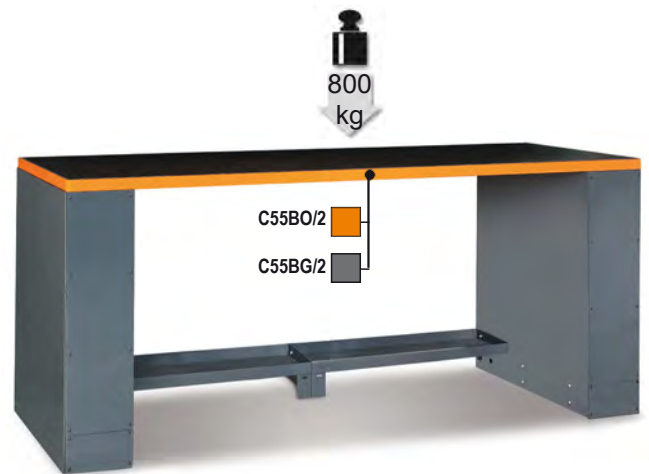

	€		
C55BO/2	1.815,00	1	055000101
C55BG/2	1.815,00	1	055000111

C55PRO B/2

2-m-long workbench, for workshop equipment combination

With worktop (2050x700 mm) covered with a shockproof, non-scratch PVC coat, resistant to hydrocarbons

Built-in sockets and hose reel:

- Schuko socket +16+10A
- EU Plug 10A
- Compressed air outlet with hose reel, Ø 8 mm, item 1901BM/8, hose length: 10 m.
- Holes for a vice (1599P/150, to be ordered separately)
- Vertically adjustable feet

110 kg

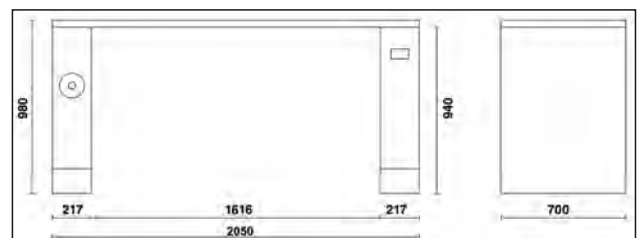
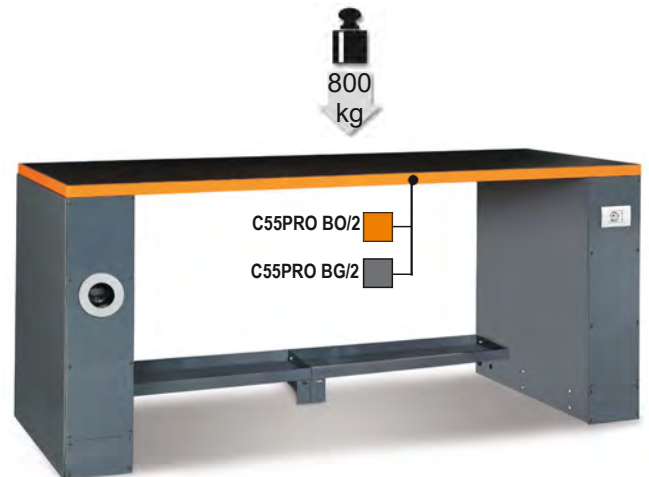

	€		
C55PRO BO/2	2.330,00	1	055000151
C55PRO BG/2	2.330,00	1	055000171

C55B/2,8

2.8-m-long workbench, for workshop equipment combination

Worktop (2850x700 mm) covered with a shockproof, non-scratch PVC coat, resistant to hydrocarbons

- Holes for a vice (1599F/150, to be ordered separately)
- Vertically adjustable feet

129 kg

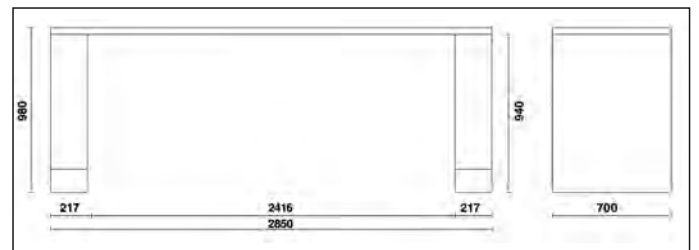
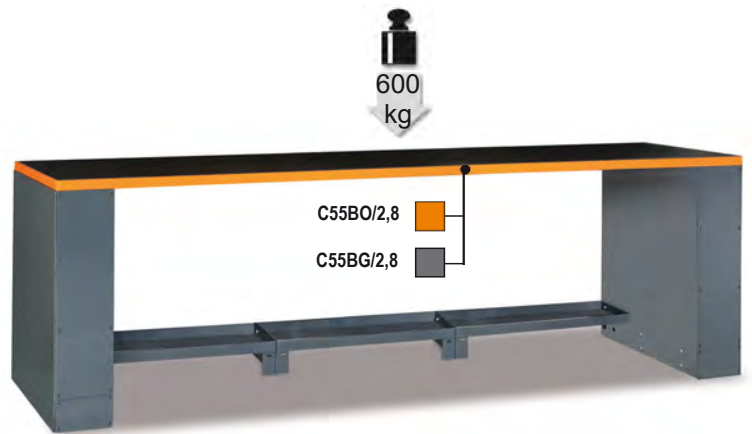

	€		
C55BO/2,8	2.280,00	1	055000261
C55BG/2,8	2.280,00	1	055000281

C55PRO B/2,8

2.8-m-long workbench, for workshop equipment combination

With worktop (2850x700 mm) covered with a shockproof, non-scratch PVC coat, resistant to hydrocarbons

Built-in sockets and hose reel:

- Schuko socket +16+10A
- EU Plug 10A
- Compressed air outlet with hose reel, Ø 8 mm, item 1901BM/8, hose length: 10 m.
- Holes for a vice (1599P/150, to be ordered separately)
- Vertically adjustable feet

134 kg

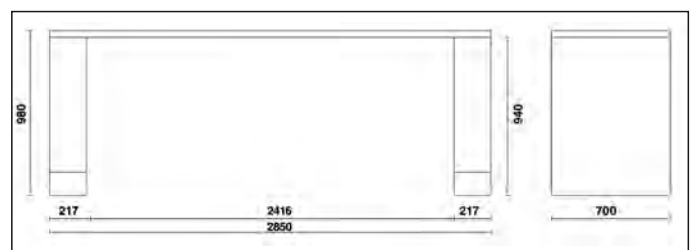
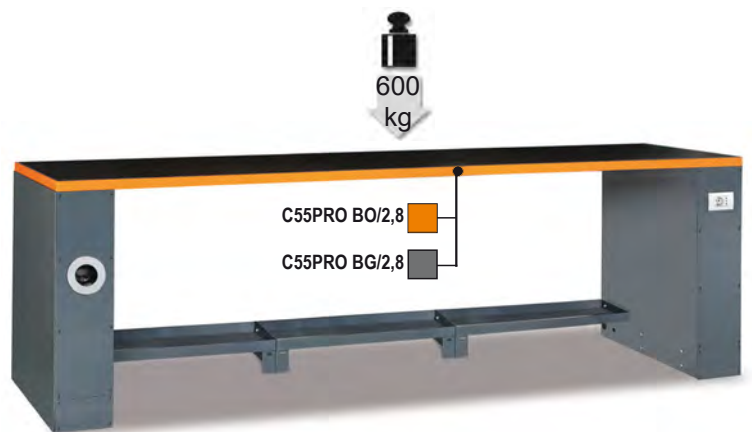

	€		
C55PRO BO/2,8	2.800,00	1	055000271
C55PRO BG/2,8	2.800,00	1	055000283

C55B-D4

double 4-m-long workbench with central leg

Worktop (4100x700 mm) covered with a shockproof, non-scratch PVC coat, resistant to hydrocarbons

- Holes for a vice 1599F/150 (to be ordered separately)
- Vertically adjustable feet
- Double central leg with compartment and slide-away door, 350x750 mm

185 kg

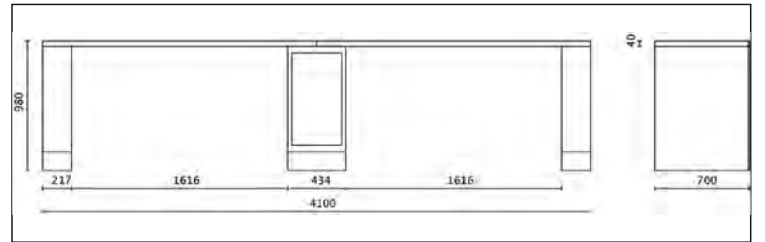
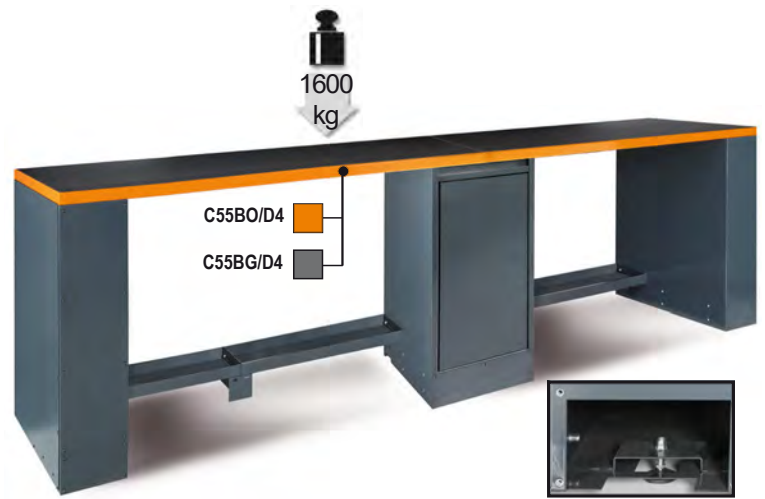

C55BO-D4	3.700,00	€	1	055000109
C55BG-D4	3.700,00	€	1	055000119

C55PRO B-D4

double 4-m long workbench with central leg

With worktop (4100x700 mm) covered with a shockproof, non-scratch PVC coat, resistant to hydrocarbons

Built-in sockets and cable reel:

- Schuko socket +16+10A
- EU Plug 10A
- Compressed air outlet with hose reel, Ø 8 mm, item 1901BM/8, cable length: 10 m.
- Holes for a vice (1599P/150, to be ordered separately)
- Vertically adjustable feet
- Double central leg with tool compartment and door, 365x750 mm

190 kg

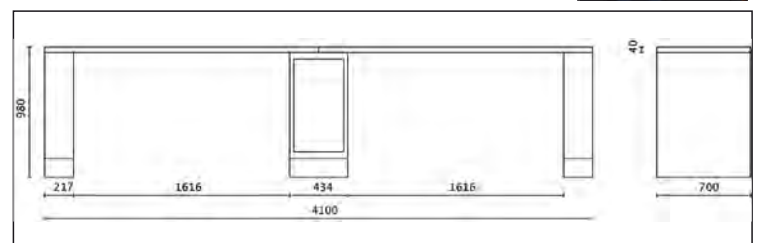
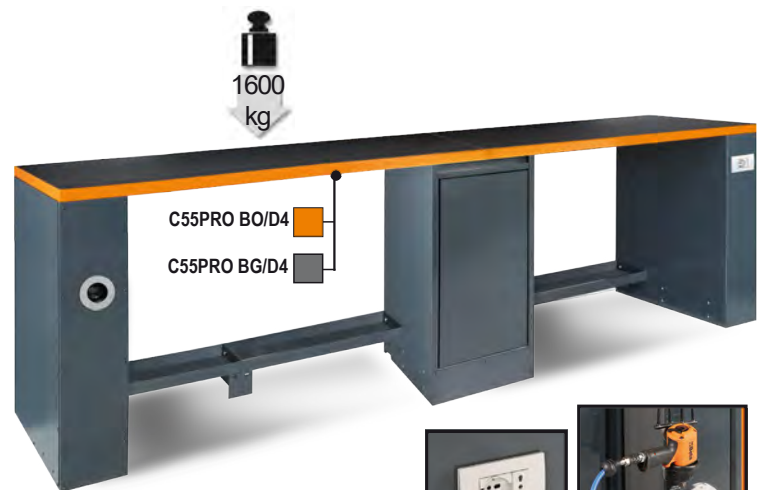

C55PRO-BO-D4	4.210,00	€	1	055000159
C55PRO-BG-D4	4.210,00	€	1	055000179

 **Beta**

C55B/G

universal leg for workshop equipment workbench

- With vertically adjustable feet

30 kg

C55B/G € 489,00 1 055000096

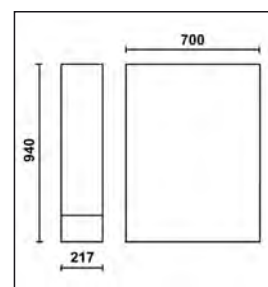

C55B/GAA

universal leg for workbench with built-in hose reel

- Built-in automatic hose reel for compressed air or cold water, Ø 8 mm, item 1901BM/8
- Hose length: 10 m
- With vertically adjustable feet
- Front and side access

35 kg

C55B/GAA € 890,00 1 055000099

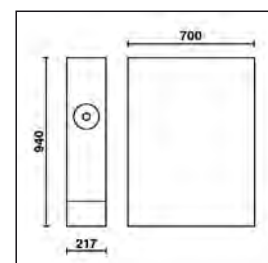

C55B/GDP

double leg for adjoining workshop equipment workbenches

- Paper roll holder compartment
- Compartment with door
- With vertically adjustable feet

45 kg

C55B/GDP € 1.158,00 1 055000292

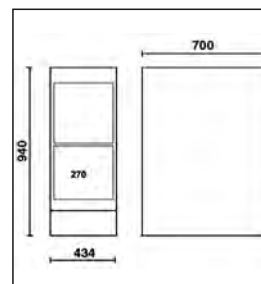

C55B/GDS

double leg for adjoining workshop equipment workbenches

- Compartment with slide-away door, 365x750 mm
- With vertically adjustable feet

45 kg

C55B/GDS € 1.044,00 1 055000291

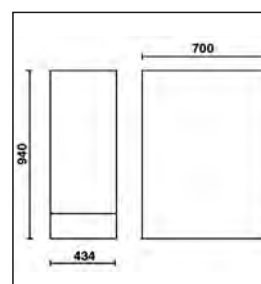

C55B/GE

universal leg with power sockets for workshop equipment workbench

- Schuko socket+16+10A
- EU Plug +10A
- With vertically adjustable feet

30 kg

C55B/GE

€ 602,00 1 055000097

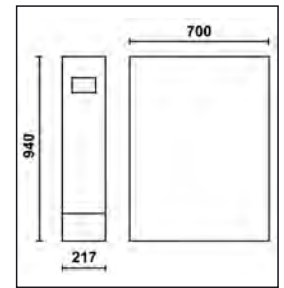

C55B/GAE

universal leg with built-in electrical cable reel for workbench, for workshop equipment combination

- Built-in automatic cable reel with Schuko type socket item 1848.
- Cable length: 15 m
- With thermal protection switch
- With vertically adjustable feet
- Front and side access

35 kg

C55B/GAE

€ 967,00 1 055000094

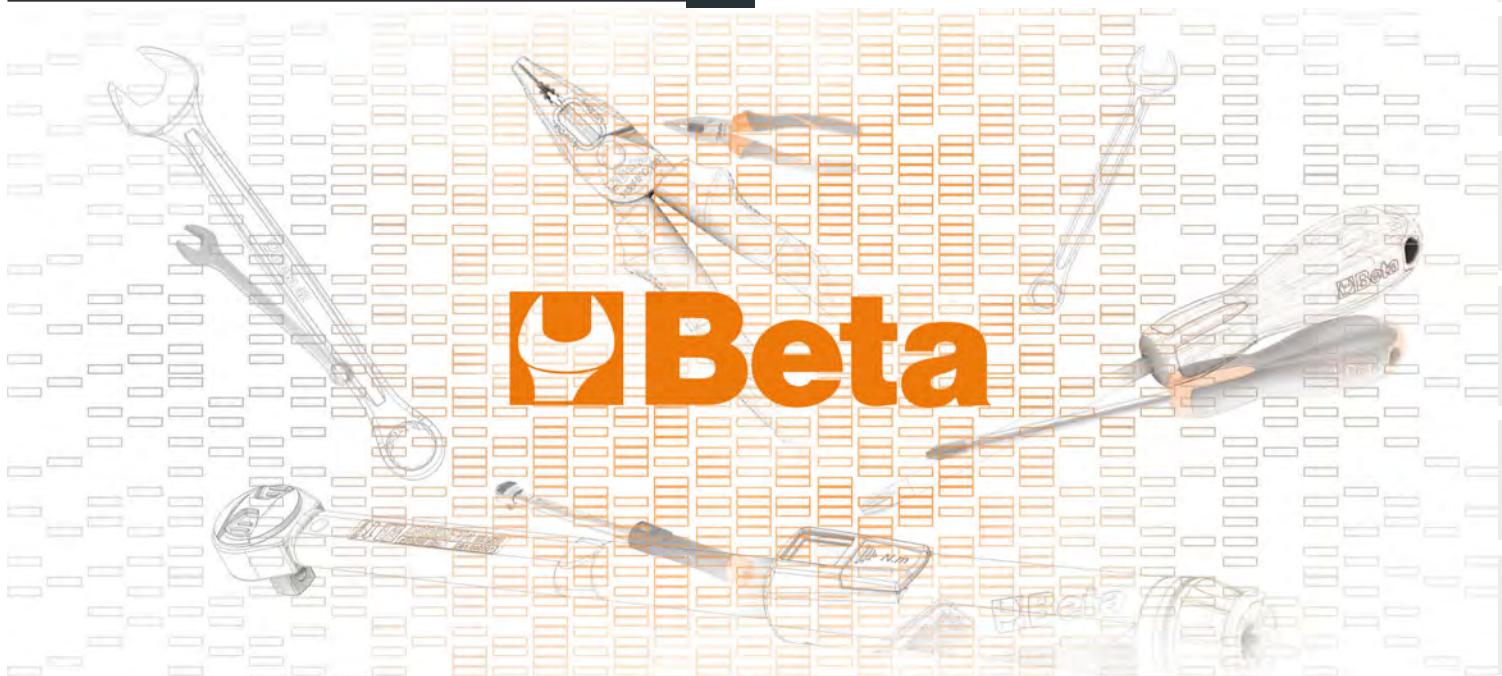
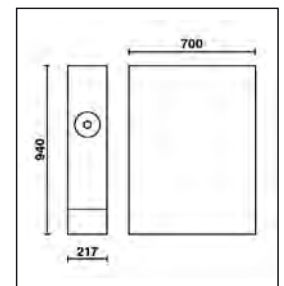
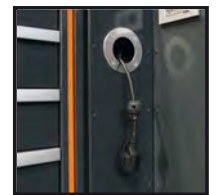

C55/PL-1,024

1-m-long worktop for workbench extension

Painted sheet metal worktop (1024x700 mm) covered with a shockproof, non-scratch PVC coat, resistant to hydrocarbons



21 kg

C55/PLO-1,024	€ 403,00	1	055000130
C55/PLG-1,024	€ 403,00	1	055000131

C55B PT/2

2-m-long worktop for workbench, for workshop equipment combination

Painted sheet metal worktop (2050x700 mm) covered with a shockproof, non-scratch PVC coat, resistant to hydrocarbons
Holes for a vice (1599P/150, to be ordered separately)

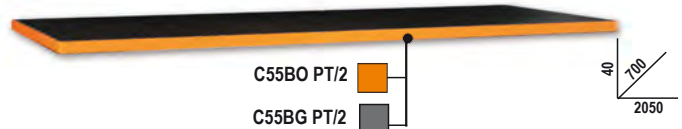

43 kg

C55B PT/2	€ 839,00	1	055000106
C55BG PT/2	€ 839,00	1	055000116

C55B PT/2,8

2.8-m-long worktop for workbench, for workshop equipment combination

Painted sheet metal worktop (2850x700 mm) covered with a shockproof, non-scratch PVC coat, resistant to hydrocarbons
Holes for a vice (1599P/150, to be ordered separately)



61 kg

C55BO PT/2,8	€ 1.305,00	1	055000266
C55BG PT/2,8	€ 1.305,00	1	055000286

C55RB

shockproof, non-scratch PVC coat, resistant to hydrocarbons

For protecting worktop.

C55RB/2: for 2-m-long worktop

C55RB/2.8: for 2.8-m-long worktop

C55RB/0.7: for 700x700mm worktop

C55RB/1: for 1-m-long worktop

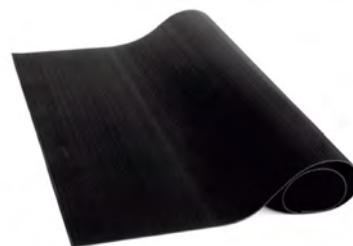

C55RB/2	€ 142,00	1	055000195
C55RB/2,8	€ 193,00	1	055000196
C55RB/0,7	€ 79,00	1	055000199
C55RB/1	€ 107,50	1	055000198

C55B/VS

lower workbench bracket, 0.8 m long

Dimensions: 800x230x60 mm

4 kg

C55B/VS	€ 107,50	1	055000095
---------	----------	---	-----------

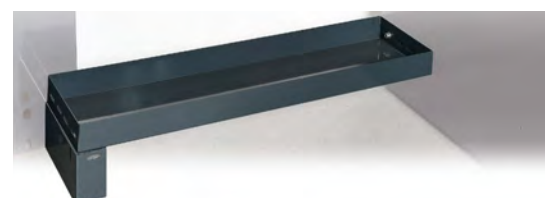

C55C7

mobile roller cab with seven drawers, for workshop equipment combination

7 drawers (588x367 mm), with ball bearing slides

- 4 castors Ø 100 mm, 2 fixed (one with brake) and 2 steering
- Aluminium opening system throughout length of drawer
- Drawer bases protected by foamed rubber mats
- Front centralized lock
- Can be fitted with foam trays

79 kg

1000 kg

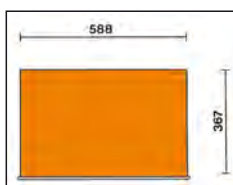

h	max
70 mm	30 kg
245 mm	40 kg

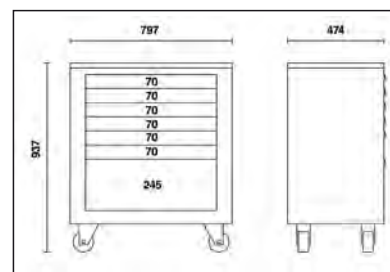

C55C7

€ 1.680,00 1 055000201

Beta

C55C8

roller cab module with eight drawers, for workshop equipment combination

- 8 drawers (588x367 mm) with ball bearing slides
- 4 castors Ø 100 mm, 2 fixed (one with brake) and 2 steering
- Aluminium opening system throughout length of drawer
- Drawer bases protected by foamed rubber mats
- Front centralized lock
- Can be fitted with foam trays

81 kg



h	max
70 mm	30 kg
175 mm	40 kg

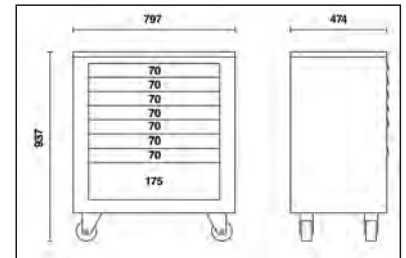
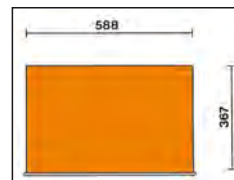

C55C8 € 1.710,00 1 055000206

C55M2

fixed module with 2 drawers, for workshop equipment combination

- 2 drawers (588x367mm) with ball bearing slides
- Aluminium opening system throughout length of drawer
- Drawer bases protected by foamed rubber mats
- Front centralized lock

66 kg



h	max
280 mm	40 kg
385 mm	40 kg

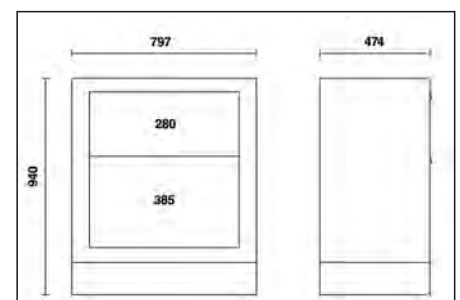
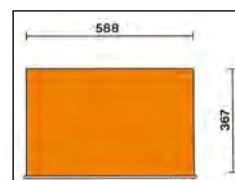

C55 M2 € 1.430,00 1 055000202

C55M4

fixed module with 4 drawers, for workshop equipment combination

- 4 drawers (588x367 mm) with ball bearing slides
- Aluminium opening system throughout length of drawer
- Drawer bases protected by foamed rubber mats
- Front centralized lock

75 kg

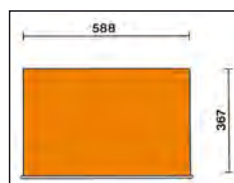

h	max
140 mm	30 kg
245 mm	40 kg

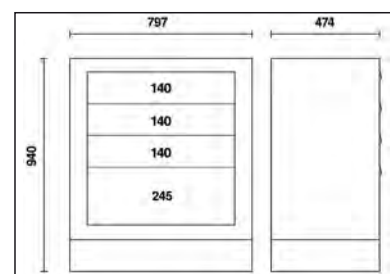

C55M4

€ 1.500,00 055000212

C55M7

fixed module with seven drawers, for workshop equipment combination

- 7 drawers (588x367 mm) with ball bearing slides
- Aluminium opening system throughout length of drawer
- Drawer bases protected by foamed rubber mats
- Front centralized lock
- Can be fitted with foam trays

78 kg

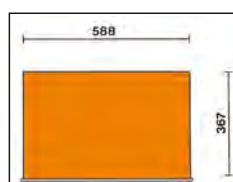

h	max
70 mm	30 kg
245 mm	40 kg

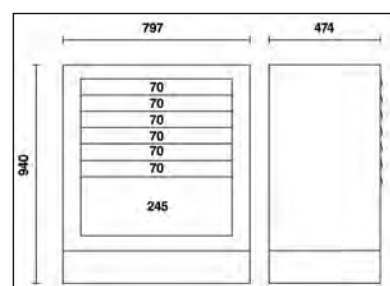

C55M7

€ 1.590,00 055000203

C55M8

fixed module with 8 drawers for workshop equipment combination

- 8 drawers (588x367 mm) with ball bearing slides
- Aluminium opening system throughout length of drawer
- Drawer bases protected by foamed rubber mats
- Front centralized lock
- Can be fitted with foam trays

📦 78,9 kg



h	max
70 mm	30 kg
175 mm	40 kg

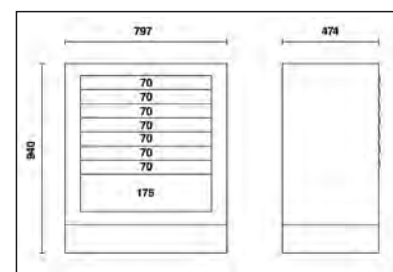
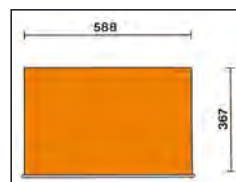

C55M8

€ 1.625,00 1 055000207

C55CS

fixed sorted waste collection module for workshop equipment combination

- Pull-out waste compartment (588x465) with ball bearing slides
- 2 capacious pull-out interior containers for sorting waste

📦 62 kg

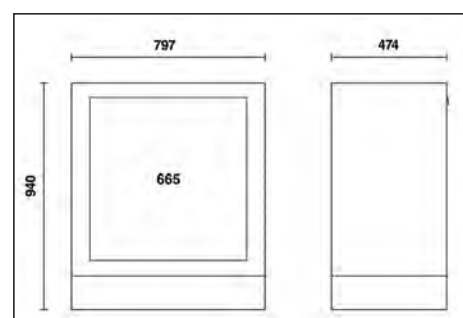

C55CS

€ 1.450,00 1 055000208

C55MA

fixed two-door module, for workshop equipment combination

- Push Pull opening
- With lock • Interior shelf, vertically adjustable

75 kg

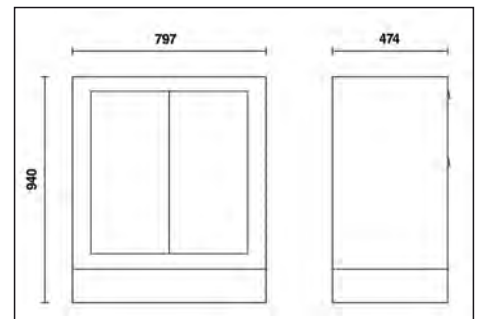

C55 MA

€ 1.235,00 1 055000205

C55MDO

fixed oil distribution module
for workshop equipment combination

- 2 reels with 7m - 1/2" hose included
- Complete with 2 guns with digital litre counter and automatic drip catcher.
- max. flow rate: 35 l/min
- viscosity: 8÷5000 mPas

94 kg

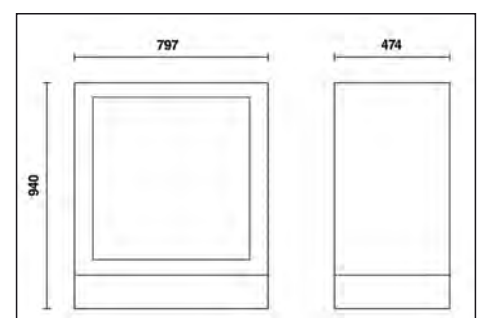

C55MDO

€ 3.140,00 1 055000210

C55MS

fixed service module, for workshop equipment combination

- Built-in waste bin
- Perforated paper roll compartment
- Storage drawer, 305x270 mm

75 kg

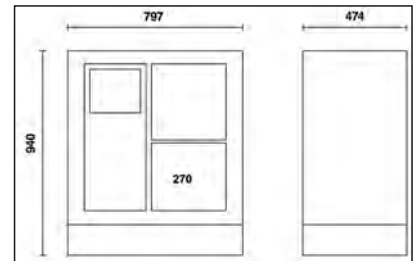

C55 MS

€ 1.305,00 1 055000204

C55T3

trolley

- 3 tops covered in antislip ribbed rubber
- Ergonomic handle
- Two fixing options for central worktop
- Four castors Ø 100 mm (two with brakes)
- Static load capacity: 200 kg (distributed between 3 shelves)

21 kg

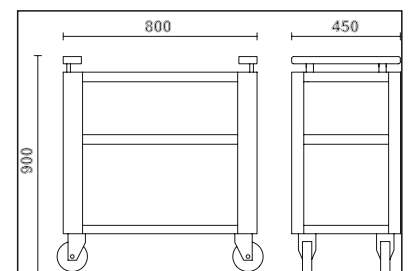

C55T3

€ 244,00 1 055000219

C55P/MCD

double central intermediate uprights

10 kg

C55P/MCD € 124,50 1 055000257



C55P/2MDX-SX

right/left wall uprights, pair

10 kg

C55P/2MDX-SX € 227,00 1 055000253



C55PM

suspended cabinet for workshop equipment combination, 1 m long

- Dimensions: 1024x400x300 mm; fitted with gas springs, making it easier to open and close door

24 kg

C55PM € 829,00 1 055000302

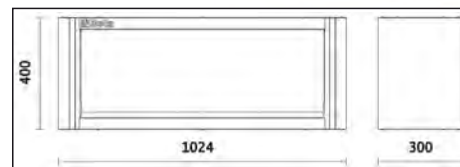

C55PFA-1,0

self-supporting perforated panel, 1 m long, for workshop equipment combination

Perforated steel tool panel (1024x1020x25 mm)

11 kg

C55PFA-1,0 € 278,00 1 055000316

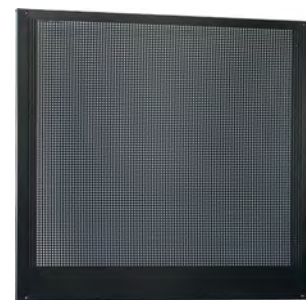

C55/PF

perforated under-cabinet panel for workshop equipment combination, 1 m long

- Perforated tool panel (1024x600 mm)

6 kg

C55/PF € 191,50 1 055000307

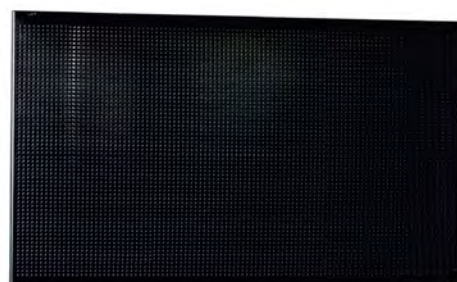

C55PT1,0X0,6

under-cabinet panel, 1 m long

Dimensions: 1024x620x25 mm

8 kg

C55PT1,0X0,6 € 153,00 1 055000314



C55PTE-1,0

under-cabinet panel, 1 m long

Dimensions: 1024x620x25 mm

Accommodates 2 power sockets (not included)

8 kg

C55PTE-1,0 € 181,50 1 055000319



C55/2PM

tool wall system with 2 suspended cabinets, for workshop equipment combination

- 2 suspended cabinets, 1024x400x300 mm, fitted with gas springs, making it easier to open and close doors.
- Wall panel, 2050x620 mm; can accommodate perforated tool panels C55/PF (to be ordered separately)
- Supplied with framework
- Matches 2-m-long workbench

80 kg

C55 2PM € 2.315,00 1 055000301

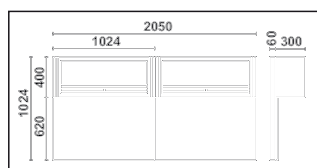
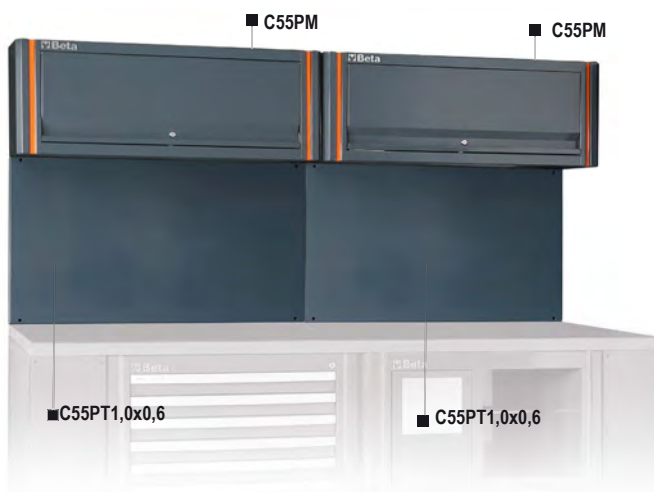

C55PFA-0,8

self-supporting perforated panel, 0.8 m long, for workshop equipment combination

Perforated steel tool panel (800x1020x25 mm)

10 kg

C55PFA-0,8

€ 256,00 1 055000315



C55PM/M0,8

suspended cupboard, 0.8 m long, for workshop equipment combination

Dimensions: 800x400x300 mm;

fitted with gas springs making it easier to open and close door

19 kg

C55PM/M0,8

€ 795,00 1 055000312

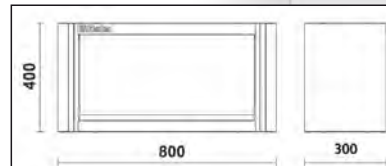

C55PTE-0,8

under-cabinet panel, 0.8 m long

Dimensions: 800x620x25 mm

Accommodates 1 power socket (not included)

6 kg

C55PTE-0,8

€ 164,50 1 055000318



C55PT0,8X0,6

under-cabinet panel, 0.8 m long

Dimensions: 800x620x25 mm

7,8 kg

C55PT0,8X0,6

€ 142,00 1 055000313



C55/1PF

perforated tool panel, for workshop equipment combination

• Perforated tool panel (800x600 mm)

5 kg

C55/1PF

€ 119,00 1 055000309

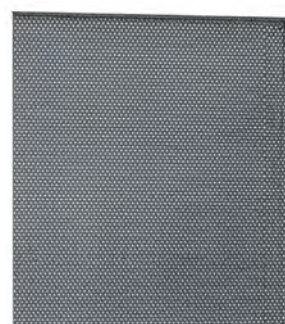

C55PS

tool wall system with shutter, for workshop equipment combination

- Aluminium shutter, vertically adjustable, with lock
- Removable perforated tool panel
- Supplied with framework
- 50-hook GPS kit included
- Matches 2-m-long workbench

88 kg

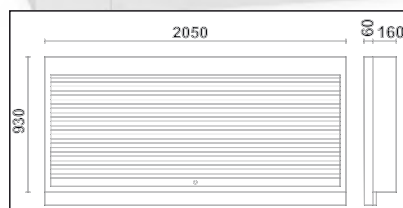

C55PS-O	€ 1.640,00	1	055000250
C55PS-G	€ 1.640,00	1	055000255

C55PSE

tool wall system with shutter accommodating 2 power sockets

- Aluminium shutter, vertically adjustable, with lock
- Removable perforated tool panel
- Supplied with framework
- 50-hook GPS kit included
- Accommodates power sockets
- Matches 2-m-long workbench

88 kg

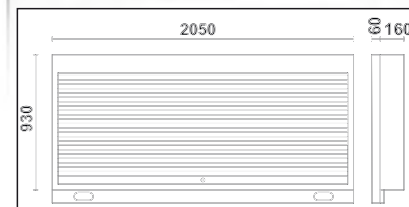

C55PSE-O	€ 1.655,00	1	055000258
C55PSE-G	€ 1.655,00	1	055000260

C55AE

profile, 2 m long, accommodating power sockets

Dimensions: 2050x25x90mm
Accommodates 2 power sockets

1,5 kg



C55AE	€ 153,00	1	055000325
-------	----------	---	-----------

C55AC

self-supporting complete corner

Worktop (700x700 mm) with legs
2 upper tool wall systems complete with 2 fixing shelves (665x150 mm)

66 kg

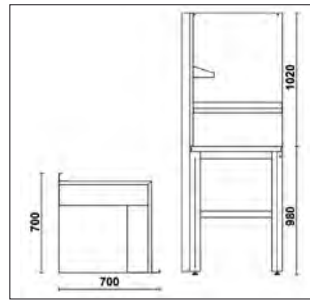

C55AC O

C55AC G



C55AC O	€ 1.895,00	1	055000360
C55AC G	€ 1.895,00	1	055000380

C55KAI

corner worktop for workshop equipment combination

• Painted sheet metal worktop (700x700 mm) covered with a shockproof, non-scratch PVC coat, resistant to hydrocarbons

32 kg

C55KAI O

C55KAI G



C55KAI O	€ 1.090,00	1	055000365
C55KAI G	€ 1.090,00	1	055000385

C55KAS

upper corner with tool wall systems

• Perforated tool wall systems (700x1020x25 mm)
• 2 fixing shelves (665x150 mm)

24 kg



C55KAS	€ 805,00	1	055000370
--------	----------	---	-----------

C55MP

steel corner wall shelves

Dimensions: 700x160x80 mm



C55MP	€ 113,50	1	055000374
-------	----------	---	-----------



C55B/1

workbench, 1 m long, for workshop equipment combination, with fixed module C55M7

Worktop (1024x700 mm) covered with a shockproof, non-scratch PVC coat, resistant to hydrocarbons

- Universal leg with vertically adjustable feet

1 fixed module:

- 7 drawers (588x367 mm) with ball bearing slides
- Aluminium opening system throughout length of drawer
- Drawer bases protected by foamed rubber mats
- Front centralized lock

127 kg



C55BO/1

C55BG/1



h	max
70 mm	30 kg

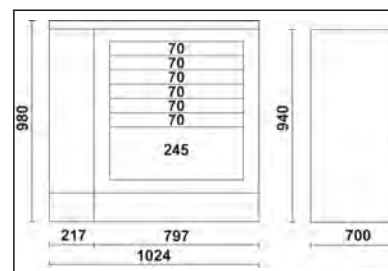
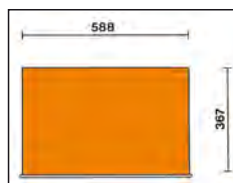

C55BO/1	€ 2.480,00	1	055000090
C55BG/1	€ 2.480,00	1	055000091

C55C

Cargo cabinets, RSC55 system

Developed on the basis of accurate research conducted with trained, professional users, they provide ideal solutions for working comfortably and rationally.

The opening system of the perforated panels of the two doors also allows the interior surface to be made the most of.

Main features:

- 1 drawer with ball bearing slides.
- Easy tool layout according to users' needs.
- Easy wall mounting by means of two slots located at the back of the cabinet.
- Safety lock for both drawers and doors.
- Empty thermoformed tray for 1/2" sockets and accessories.

37 kg

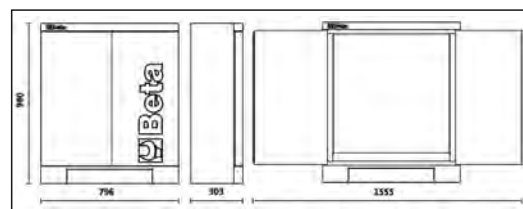

C55C	€ 684,00	1	055000400
------	----------	---	-----------

C55A1

sheet metal single-door tool cabinet, for workshop equipment combination

- 3 removable, vertically adjustable shelves
- With lock
- Usable interior dimensions: 177x42x42 cm

50 kg

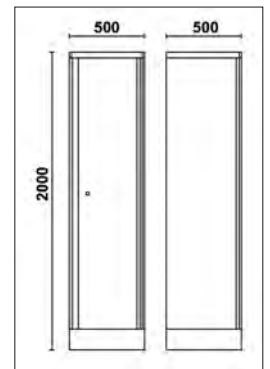

C55A1

€ 602,00 1 055000411

C55A1/R42

interior shelf for tool cabinet C55A1/C55AT1

2,4 kg



C55A1/R42

420x420 mm

€ 26,00 1 055000461

Beta

C55A2

sheet metal two-door tool cabinet, for workshop equipment combination

- 3 removable, vertically adjustable shelves
- With lock
- Usable interior dimensions: 177x70x42 cm

72 kg

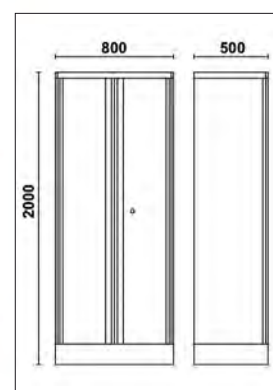

C55A2

€ 806,00 1 055000412

C55A2/R70

interior shelf for tool cabinet C55A2/C55AT2

3,5 kg



C55A2/R70

700x420 mm

€ 42,00 1 055000462

Beta

C55AT1

sheet metal tool cabinet with clear polycarbonate door, for workshop equipment combination

- 3 removable, vertically adjustable shelves
- With lock
- Usable interior dimensions: 1770x420x420 mm

41 kg

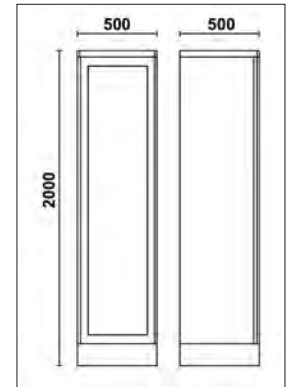

C55AT1

€ 670,00 1 055000421

C55AT2

sheet metal tool cabinet with two clear polycarbonate doors, for workshop equipment combination

- 3 removable, vertically adjustable shelves
- With lock
- Usable interior dimensions: 1770x700x420 mm

56 kg

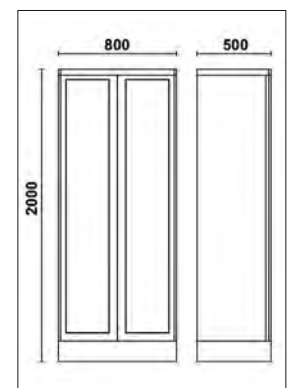

C55AT2

€ 909,00 1 055000422

C55STR

adhesive tape 25 m

allows to tailor the vertical tapes of garage furniture item C55



RAL2011
RAL3000
RAL6029
RAL9016
RAL1023
RAL5015
RAL1035
RAL9006

Code	Color	Price (€)	Quantity	Article No.
C55STR-O/2011	Orange	61,00	1	055000901
C55STR-R/3000	Red	61,00	1	055000903
C55STR-V/6029	Green	61,00	1	055000906
C55STR-W/9016	White	61,00	1	055000907
C55STR-Y/1023	Yellow	61,00	1	055000905
C55STR-B/5015	Blue	61,00	1	055000904
C55STR-GO/1035	Grey	61,00	1	055000909
C55STR-S/9006	Black	61,00	1	055000902



PROFESSIONAL STURDY TIDY

**NEW
DESIGN**

C45PRO is the professional workshop equipment that helps you make the most of your working space. Based on the new 2021 design and the technical improvements developed for the frame, it boasts an excellent quality/price ratio.

The **modular workshop equipment**, C45PRO, allows you to create your own work environment according to both the amount of space you have available and your usage requirements. This simple, flexible range based on predetermined combinations, can be expanded or changed in time. Alternatively, you can fully customize your workstation, starting with the worktops – available in stainless steel coated MDF or multi-ply wood – and supplementing them with the numerous parts and accessories you can choose from.

Tailor your work environment to suit your needs. Make your workshop or garage look different. Choose from the preassembled solutions or create your workstation from scratch.



THE WORKSHOP EQUIPMENT, C45, HAS CHANGED ITS APPEARANCE AND PUT ON THE BETA COLOURS!

C45PRO X

workshop equipment combination C45PRO

Combination comprising:

- Stainless steel coated MDF worktop (C45PX/3-2.0MT)
- Fixed module with 7 drawers (C45PRO M7)
- Fixed service module (C45PRO MS)
- Mobile roller cab with 7 drawers (C45PRO C7)
- Two-door tool cabinet (C45PRO AS2)
- 3 perforated tool panels (C45PRO PF)
- 3 wall-mounted cabinets (C45PRO PM)
- 3 wall brackets, wide type (C45PRO SL)
- 1 wall bracket, narrow type (C45PRO SS)

305 kg



C45PRO X 3.960,00 € 1 045000001

2000
495
2955

C45PRO W

workshop equipment combination C45PRO

Combination comprising:

- Multi-ply wood worktop (C45PW/3-2,0MT)
- Fixed module with 7 drawers (C45PRO M7)
- Fixed service module (C45PRO MS)
- Mobile roller cab with 7 drawers (C45PRO C7)
- Two-door tool cabinet (C45PRO AS2)
- 3 perforated tool panels (C45PRO PF)
- 3 wall-mounted cabinets (C45PRO PM)
- 3 wall brackets, wide type (C45PRO SL)
- 1 wall bracket, narrow type (C45PRO SS)

303 kg

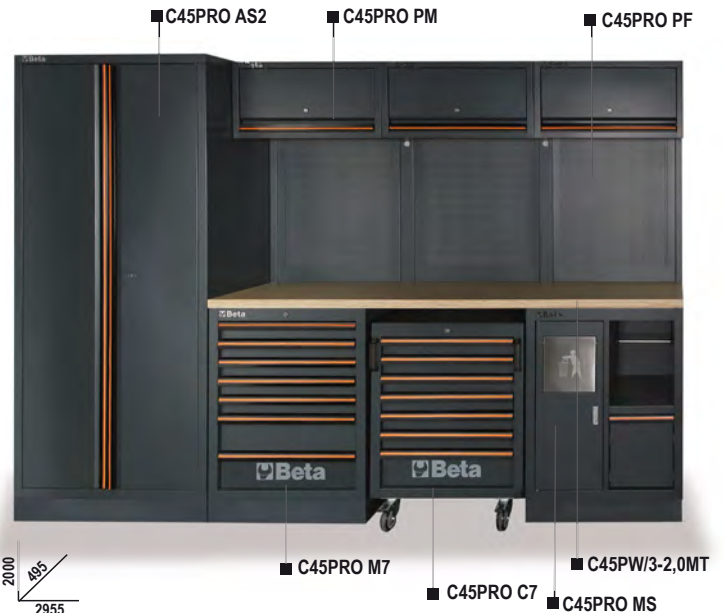

C45PRO W

€ 3.860,00 1 045000002

C45PRO AX

workshop equipment combination C45PRO

Combination comprising:

- Stainless steel coated MDF worktop (C45PX/3-2,0MT)
- Fixed module with 7 drawers (C45PRO M7)
- Fixed service module (C45PRO MS)
- Fixed two-door module (C45PRO MA)
- 3 wall-mounted cabinets (C45PRO PM)
- 3 perforated tool panels (C45PRO PF)
- 2 wall brackets, wide type (C45PRO SL)
- 2 wall brackets, narrow type (C45PRO SS)

206 kg



C45PRO AX

€ 2.760,00 1 045000003

C45PRO AW

workbenches for workshop equipment combination C45PRO

Combination comprising:

- Multi-ply wood worktop (C45PW/3-2,0MT)
- Fixed module with 2 drawers (C45PRO MA)
- Fixed module with 7 drawers (C45PRO M7)
- Fixed service module (C45PRO MS)
- 3 wall-mounted cabinets (C45PRO PM)
- 3 perforated tool panels (C45PRO PF)
- 2 wall brackets, narrow type (C45PRO SS)
- 2 wall brackets, wide type (C45PRO SL)

204 kg



C45PRO AW

€ 2.650,00 1 045000004

C45PRO BX

workshop equipment combination C45PRO

Combination comprising:

- Stainless steel coated MDF worktop (C45PX/2-1.3MT)
- Fixed module with 5 drawers (C45PRO M5)
- Fixed two-door module (C45PRO MA)
- Single-door tool cabinet (C45PRO AS1)
- 2 wall-mounted cabinets (C45PRO PM)
- 2 perforated tool panels (C45PRO PF)
- 2 wall brackets, wide type (C45PRO SL)
- 1 wall bracket, narrow type (C45PRO SS)

191 kg

C45PRO BX € 2.450,00 1 045000021

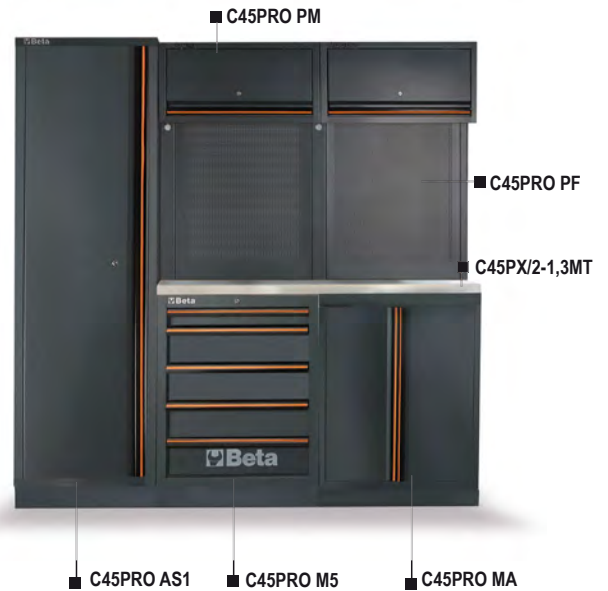

C45PRO BW

workshop equipment combination C45PRO

Combination comprising:

- Multi-ply wood worktop (C45PW/2-1.3MT)
- Fixed module with 5 drawers (C45PRO M5)
- Fixed two-door module (C45PRO MA)
- Single-door tool cabinet (C45PRO AS1)
- 2 wall-mounted cabinets (C45PRO PM)
- 2 perforated tool panels (C45PRO PF)
- 2 wall brackets, wide type (C45PRO SL)
- 1 wall bracket, narrow type (C45PRO SS)

190 kg

C45PRO BW € 2.350,00 1 045000022



C45PRO DX

workshop equipment combination C45PRO

Combination comprising:

- 1 stainless steel coated MDF worktop (C45PX/3-2,0MT)
- 1 stainless steel coated MDF worktop (C45PX/2-1,3MT)
- 1 fixed module with 7 drawers (C45PRO M7)
- 1 mobile roller cab with 7 drawers (C45PRO C7)
- 1 fixed service module (C45PRO MS)
- 1 fixed module with 5 drawers (C45PRO M5)
- 1 two-door fixed module (C45PRO MA)
- 1 self-supporting complete corner with stainless steel coated MDF worktop (C45PRO C/X)
- 5 perforated tool panels (C45PRO PF)
- 5 wall-mounted cabinets (C45PRO PM)
- 7 wall brackets, wide type (C45PRO SL)
- 2 wall brackets, narrow type (C45PRO SS)
- 2 single-door cabinets (C45PRO AS1)

572,3 kg

C45PRO DX € 7.810,00 1 045000031

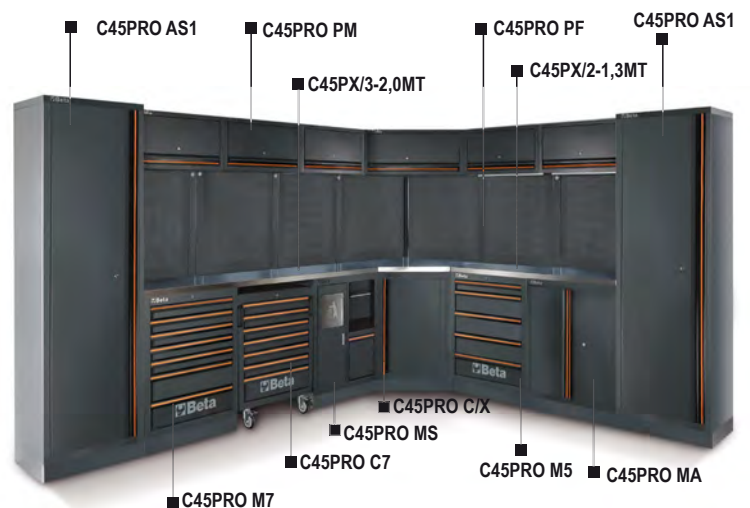
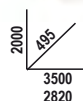

C45PRO DW

workshop equipment combination C45PRO

Combination comprising:

- 1 multi-ply wood worktop (C45PW/3-2.0MT)
- 1 multi-ply wood worktop (C45PW/2-1.3MT)
- 1 fixed module with 7 drawers (C45PRO M7)
- 1 mobile roller cab with 7 drawers (C45PRO C7)
- 1 fixed service module (C45PRO MS)
- 1 fixed module with 5 drawers (C45PRO M5)
- 1 fixed two-door module (C45PRO MA)
- 1 self-supporting complete corner with wood worktop (C45PRO C/W)
- 5 perforated tool panels (C45PRO PF)
- 5 wall-mounted cupboards (C45PRO PM)
- 7 wall brackets, wide type (C45PRO SL)
- 2 wall brackets, narrow type (C45PRO SS)
- 2 single-door cabinets (C45PRO AS1)

568,5 kg

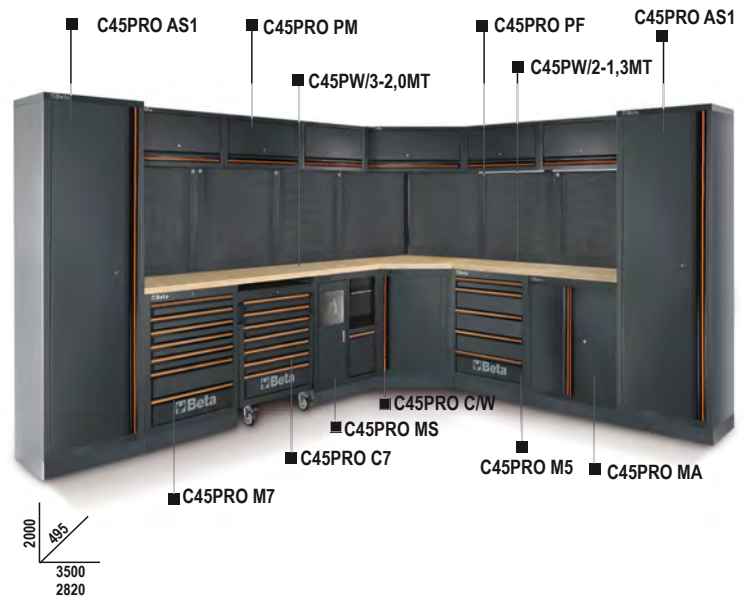

C45PRO DW

€ 7.550,00 1 045000032

C45PRO EX

workshop equipment combination C45PRO

Combination comprising:

- 2 perforated tool panels (C45PRO PF)
- 2 wall-mounted cabinets (C45PRO PM)
- 2 wall brackets, wide type (C45PRO SL)
- 1 wall bracket, narrow type (C45PRO SS)
- 1 single-door cabinet (C45PRO AS1)
- Fixed module with 7 drawers and stainless steel coated MDF worktop (C45PRO M7A/X):
 - 1 drawer, 1248x406 mm
 - 6 drawers, 782x406 mm
 - 5 drawers, 85 mm high
 - 1 drawer, 155 mm high
- 1 storage compartment with intermediate shelf and door

174,6 kg



C45PRO EX

€ 2.640,00 1 045000033

C45PRO EW

workshop equipment combination C45PRO

Combination comprising:

- 2 perforated tool panels (C45PRO PF)
- 2 wall-mounted cabinets (C45PRO PM)
- 2 wall brackets, wide type (C45PRO SL)
- 1 wall bracket, narrow type (C45PRO SS)
- 1 single-door tool cabinet (C45PRO AS1)
- Fixed module with 7 drawers and multi-ply wood worktop (C45PRO M7A/W):
 - 1 drawer, 1248x406 mm
 - 6 drawers, 782x406 mm
 - 5 drawers, 85 mm high
 - 1 drawer, 155 mm high
- 1 storage compartment with intermediate shelf and door

173,6 kg

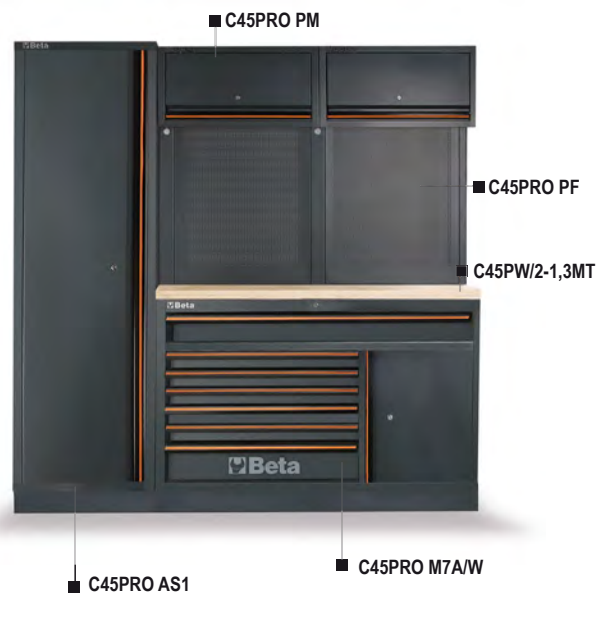

C45PRO EW

€ 2.550,00 1 045000034

C45PRO CX

workshop equipment combination C45PRO

Combination comprising:

- Worktop made of stainless steel coated MDF (C45PX/2-1.3MT)
- Fixed module with 7 drawers (C45PRO M7)
- Fixed service module (C45PRO MS)
- Single-door cabinet (C45PRO AS1)
- 2 wall-mounted cabinets (C45PRO PM)
- 2 perforated tool panels (C45PRO PF)
- 2 wall brackets, wide type (C45PRO SL)
- 1 wall bracket, narrow type (C45PRO SS)

199 kg

C45PRO CX 2.660,00 € 1 045000023



C45PRO CW

workshop equipment combination C45PRO

Combination comprising:

- Multi-ply wood worktop (C45PW/2-1.3MT)
- Fixed module with 7 drawers (C45PRO M7)
- Fixed service module (C45PRO MS)
- Single-door cabinet (C45PRO AS1)
- 2 wall-mounted cabinets (C45PRO PM)
- 2 perforated tool panels (C45PRO PF)
- 2 wall brackets, wide type (C45PRO SL)
- 1 wall bracket, narrow type (C45PRO SS)

198 kg

C45PRO CW 2.560,00 € 1 045000024



C45PRO BPX-1,3

workbenches for workshop equipment combination C45PRO

Combination comprising:

- Worktop made of stainless steel coated MDF (C45PX/2-1.3MT)
- Fixed module with 7 drawers (C45PRO M7)
- Fixed module with 5 drawers (C45PRO M5)
- 2 perforated tool panels (C45PRO PF)
- 1 wall bracket, wide type (C45PRO SL)
- 2 wall brackets, narrow type (C45PRO SS)

140 kg

C45PRO BPX-1,3 1.750,00 € 1 045000041



C45PRO BPW-1,3

workbenches for workshop equipment combination C45PRO

Combination comprising:

- Multi-ply wood worktop (C45PW/2-1,3MT)
- Fixed module with 7 drawers (C45PRO M7)
- Fixed module with 5 drawers (C45PRO M5)
- 2 perforated tool panels (C45PRO PF)
- 1 wall bracket, wide type (C45PRO SL)
- 2 wall brackets, narrow type (C45PRO SS)

139 kg

C45PRO BPW-1,3

€ 1.650,00 1 045000051



C45PRO BPX-2,0

workbenches for workshop equipment combination C45PRO

Combination comprising:

- Worktop made of stainless steel coated MDF (C45PX/3-2,0MT)
- Fixed module with 7 drawers (C45PRO M7)
- Fixed module with 5 drawers (C45PRO M5)
- 3 perforated tool panels (C45PRO PF)
- 2 wall brackets, wide type (C45PRO SL)
- 2 wall brackets, narrow type (C45PRO SS)

158 kg

C45PRO BPX-2,0

€ 1.980,00 1 045000042



C45PRO BPW-2,0

workbenches for workshop equipment combination C45PRO

Combination comprising:

- Multi-ply wood worktop (C45PW/3-2,0MT)
- Fixed module with 7 drawers (C45PRO M7)
- Fixed module with 5 drawers (C45PRO M5)
- 3 perforated tool panels (C45PRO PF)
- 2 wall brackets, wide type (C45PRO SL)
- 2 wall brackets, narrow type (C45PRO SS)

156 kg

C45PRO BPW-2,0

€ 1.875,00 1 045000052



C45PRO M7A/X

fixed module with 7 drawers, for workshop equipment combination C45PRO

- Stainless steel coated MDF worktop, 1360 mm long
- 1 drawer (1248x406 mm) with ball bearing slides
- 6 drawers (782x406 mm) with ball bearing slides:
 - 5 drawers, 85 mm high
 - 1 drawer, 155 mm high
- Drawer bases protected by foamed rubber mats
- Front centralized lock
- With vertically adjustable feet
- Can be fitted with thermoformed trays
- 1 storage compartment with intermediate shelf and door, interior dimensions 504x424x597 mm

81 kg



h	max
65 mm	25 kg
105 mm	40 kg
145 mm	30 kg

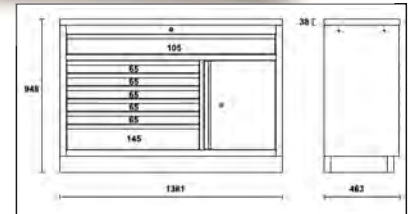

C45PRO M7A/X

€ 1.330,00 1 045000161

C45PRO M7A/W

fixed module with 7 drawers, for workshop equipment combination C45PRO

- Multi-ply wood worktop, 1360 mm long
- 1 drawer (1248x406 mm) with ball bearing slides
- 6 drawers (782x406 mm) with ball bearing slides:
 - 5 drawers, 85 mm high
 - 1 drawer, 155 mm high
- Drawer bases protected by foamed rubber mats
- Front centralized lock
- With vertically adjustable feet
- Can be fitted with thermoformed trays
- 1 storage compartment with intermediate shelf and door, interior dimensions 504x424x597 mm

80 kg



h	max
65 mm	25 kg
105 mm	40 kg
145 mm	30 kg

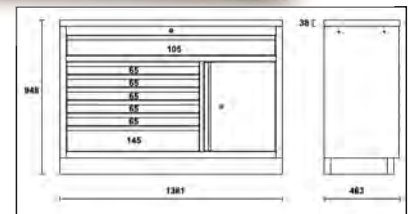

C45PRO M7A/W

€ 1.245,00 1 045000171

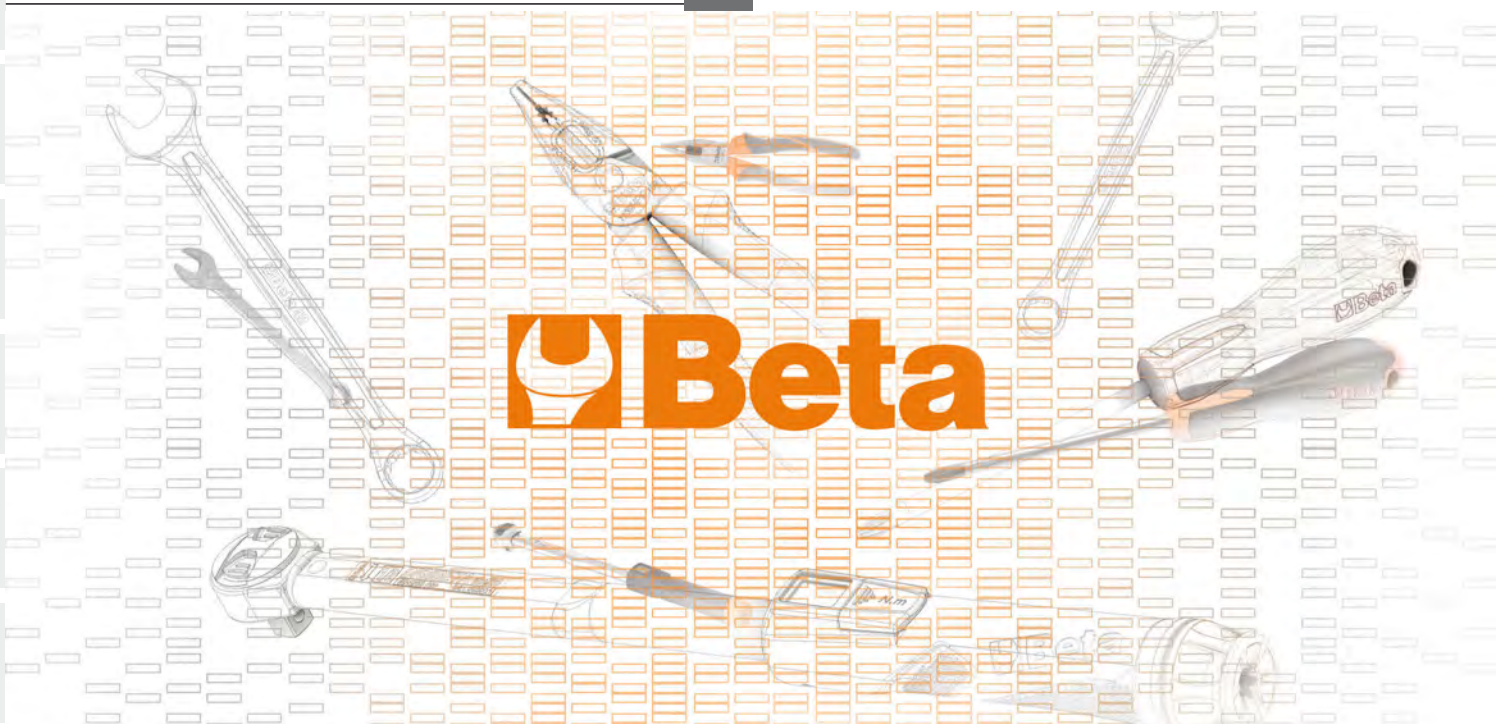

C45PX/1-0,7MT

worktop made of stainless steel coated MDF, 680x463 mm, for workbenches for workshop equipment combination C45PRO

- Thickness: 38 mm

6 kg



C45PX/1-0,7MT

€ 171,00 1 045000101

C45PW/1-0,7MT

multi-ply wood worktop, 680x463 mm, for workbenches for workshop equipment combination C45PRO

- Thickness: 38 mm
- Holes for a vice (1599P/150, to be ordered separately)

6 kg



C45PW/1-0,7MT

€ 101,00 1 045000111

C45PX/2-1,3MT

worktop made of stainless steel coated MDF, 1360x463 mm, for workbench, for workshop equipment combination C45PRO

- Thickness: 38 mm

21 kg



C45PX/2-1,3MT

€ 273,00 1 045000103

C45PW/2-1,3MT

multi-ply wood worktop, 1360x463 mm, for workbench, for workshop equipment combination C45PRO

- Thickness: 38 mm
- Holes for a vice (1599P/150, to be ordered separately)

20 kg



C45PW/2-1,3MT

€ 174,50 1 045000113

C45PX/3-2,0MT

worktop made of stainless steel coated MDF, 2040x463 mm, for workbench, for workshop equipment combination C45PRO

- Thickness: 38 mm

31,8 kg



C45PX/3-2,0MT

€ 366,00 1 045000110

C45PW/3-2,0MT

multi-ply wood worktop, 2040x463 mm, for workbench, for workshop equipment combination C45PRO

- Thickness: 38 mm
- Holes for a vice (1599P/150, to be ordered separately)

30 kg



C45PW/3-2,0MT

€ 261,00 1 045000120

C45PRO C7

mobile roller cab with 7 drawers, for workshop equipment combination
C45PRO

- 7 drawers (532x406 mm) with ball bearing slides
- 4 steering wheels, Ø 100 mm (1 with brake)
- Drawer bases protected by foamed rubber mats
- Front centralized lock
- With vertically adjustable feet
- Can be fitted with thermoformed trays
- Handles built into frame for improved ease of handling

📦 50 kg

h	max
65 mm	25 kg
145 mm	30 kg

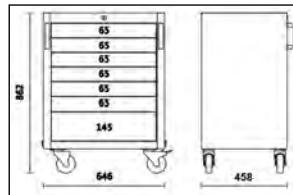
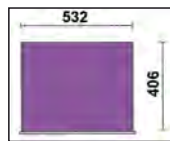

C45PRO C7

€ 669,00 1 045000227

C45PRO M4

fixed module with 4 drawers, for workshop equipment combination
C45PRO

- 4 drawers (566x406 mm) with ball bearing slides
- Drawer bases protected by foamed rubber mats
- Front centralized lock
- With vertically adjustable feet
- Can be fitted with thermoformed trays

📦 45,7 kg

h	max
65 mm	25 kg
145 mm	30 kg
225 mm	30 kg

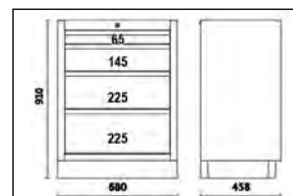
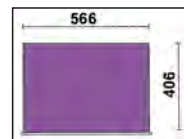

C45PRO M4

€ 547,00 1 045000234

C45PRO M5

fixed module with 5 drawers, for workshop equipment combination
C45PRO

- 5 drawers (566x406 mm) with ball bearing slides
- Drawer bases protected by foamed rubber mats
- Front centralized lock
- With vertically adjustable feet
- Can be fitted with thermoformed trays

📦 49,3 kg

h	max
65 mm	25 kg
145 mm	30 kg

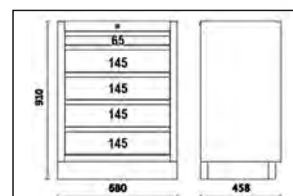
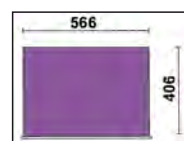

C45PRO M5



€ 546,00 1 045000235

C45PRO M7

fixed module with 7 drawers, for workshop equipment combination C45PRO

- 7 drawers (566x406 mm) with ball bearing slides
- Drawer bases protected by foamed rubber mats
- Front centralized lock
- With vertically adjustable feet
- Can be fitted with thermoformed trays

📦 54,3 kg

h		
	65 mm	25 kg
	145 mm	30 kg

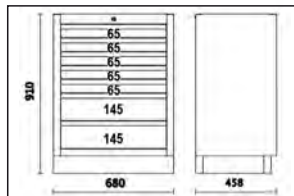
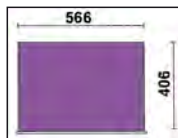

C45PRO M7

€ 645,00 1 045000237

C45PRO MS

fixed service module for workshop equipment combination C45PRO

- Built-in waste bin
- Paper roll compartment
- With vertically adjustable feet

📦 37 kg

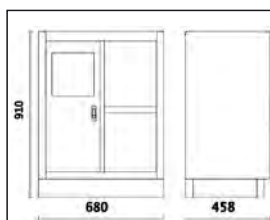

C45PRO MS

€ 437,00 1 045000239

C45PRO MA

fixed two-door module for workshop equipment combination C45PRO

- With lock
- Vertically adjustable interior shelf
- Interior dimensions 670x420 mm
- With vertically adjustable feet

📦 29,4 kg

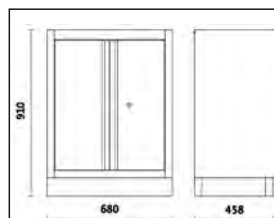

C45PRO MA

€ 325,00 1 045000232

C45PRO ML

fixed module with built-in sink, for workshop equipment combination C45PRO

Technical specifications:

- Stainless steel basin.
- Supplied complete with:
 - 1 mixer tap
 - 1 drain unit
 - 1 sink stopper
 - 1 filter cap
 - 1 soap dispenser

Fixed two-door module with lock:

- Useful interior dimensions 600x603x416 mm
- With vertically adjustable feet

📦 44 kg

C45PRO ML

€ 881,00 1 045000233

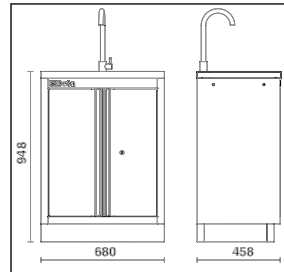

C45PRO ACT

fixed module with 3 drawers and 2 built-in reels for workshop equipment combination C45PRO

- 3 drawers (566x406 mm) with ball bearing slides
- Drawer bases protected by foamed rubber mats
- Front centralized lock
- With vertically adjustable feet

Supplied complete with:

- 1 built-in compressed air or cold water hose reel, Ø 8 mm, length 10 m, item 1900S 8x10
- 1 built-in electrical cable reel with Schuko socket, length 15 m, item 1844 15-H05SCK

📦 47 kg

C45PRO ACT

€ 892,00 1 045000247

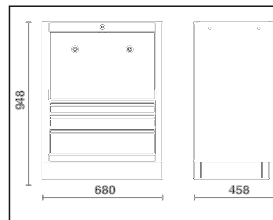

C45PRO TC

fixed reel module with 3 drawers for workshop equipment combination C45PRO

- 3 drawers (566x406 mm) with ball bearing slides
- Drawer bases protected by foamed rubber mats
- Front centralized lock
- With vertically adjustable feet
- Can accommodate 2 reels, to be chosen from the following:
 - 2 compressed air or cold water hose reels, Ø 8 mm, length 10 m, item 1900S 8x10
 - 2 electrical cable reels with Schuko type sockets, length 15 m, item 1844, 15-H05SCK
 - 1 compressed air or cold water hose reel, Ø 8 mm, length 10 m, item 1900S 8x10, and 1 cable reel with Schuko type socket, length 15 m, item 1844, 15-H05SCK

📦 38 kg

C45PRO TC

€ 510,00 1 045000249

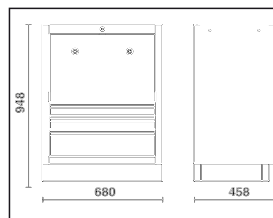

C45PRO SS

side wall brackets, narrow type, for workshop equipment combination C45PRO

- Dimensions 1420x32.5x30 mm

1,5 kg



C45PRO SS

€ 25,00 1 045000333

C45PRO SL

side wall brackets, wide type, for workshop equipment combination C45PRO

- Dimensions 1420x65x30 mm

2 kg

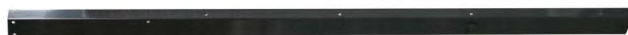

C45PRO SL

€ 33,00 1 045000366

C45PRO PA

tool wall system for workshop equipment combination C45PRO

- Aluminium shutter, vertically adjustable, with lock.
- Two removable perforated tool panels.
- Matches 1.3-m-long workbench.

46,8 kg

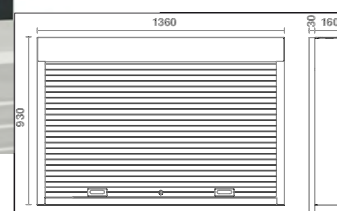

C45PRO PA

€ 930,00 1 045000280

C45PRO PF

perforated tool panel for workshop equipment combination C45PRO

- Dimensions 1052x614.5x24 mm

5,3 kg



C45PRO PF

€ 102,00 1 045000313

 **Beta**

C45PRO PFE

perforated tool panel for workshop equipment combination C45PRO

- Dimensions 1052x614,5x24 mm
- Can be fitted with 1 power socket (not included)

5,3 kg

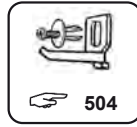

C45PRO PFE € 96,50 1 045000312

C45PRO C/X

self-supporting complete corner for workshop equipment combination C45PRO

- Suspended corner cabinet with gas springs, making it easier to open and close door
- 2 perforated tool panels (1052x860)
- Stainless steel corner worktop (860x860 mm)
- Lower corner module with large storage compartment
- With vertically adjustable feet

94 kg



C45PRO C/X € 1.665,00 1 045000401

C45PRO C/W

self-supporting complete corner for workshop equipment combination C45PRO

- Suspended corner cabinet with lock and gas springs, making it easier to open and close door
- 2 perforated tool panels (1052x860 mm)
- Multi-ply wood corner worktop (860x860 mm)
- Lower corner module with large storage compartment
- With vertically adjustable feet

93 kg



C45PRO C/W € 1.605,00 1 045000411

C45PRO PM

wall-mounted cabinet for workshop equipment combination C45PRO

- With gas springs, making it easier to open and close door

10 kg

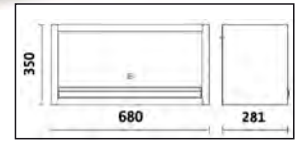

C45PRO PM

€ 187,50 1 045000302

C45PRO AS1

sheet metal single-door tool cabinet with bracket, for workshop equipment combination C45PRO

- 4 removable, vertically adjustable shelves
- With lock
- Interior dimensions 590x430 mm
- With vertically adjustable feet

57,5 kg

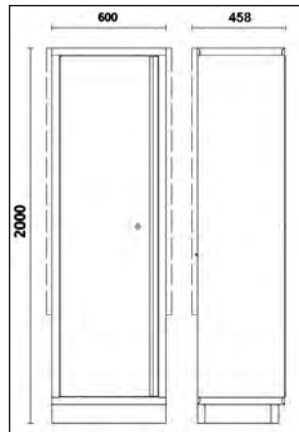

C45PRO AS1

€ 668,00 1 045000451

C45PRO AS2

sheet metal two-door tool cabinet with bracket, for workshop equipment combination C45PRO

- 4 removable, vertically adjustable shelves
- With lock
- Interior dimensions 910x430 mm
- With vertically adjustable feet

80 kg

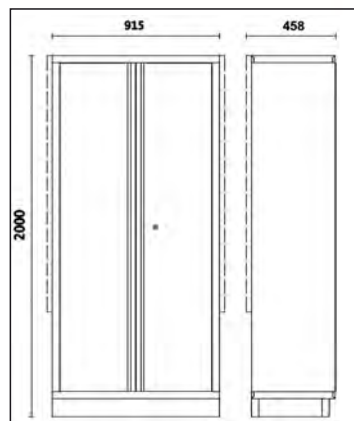

C45PRO AS2

€ 888,00 1 045000481

ACCESSORIES RSC55 - C45PRO

C45LMP

LED lamp for workshop equipment combination C45PRO - RSC55

- Length: 630 mm
- Easy to fix under wall cabinet through adhesives
- ON/OFF switch
- 570 lumens



307 g

C45LMP € 105,00 1 045000320

PM/5C

5-tray tool holder, made of plastic, with support

- Interior dimensions of tray: 95x120 mm
- Can be used with tool wall systems C45PRO and RSC55



1,8 kg

PM/5C € 82,00 1 088880450

PM/6C

6-tray tool holder, made of plastic, with support

- Interior dimensions of tray: 80x60 mm
- Can be used with tool wall systems C45PRO and RSC55



970 g

PM/6C € 64,00 1 088880440

CP

wall-mounted bottle holder rack, made of steel

- Can be used with wall-mounted tool panels

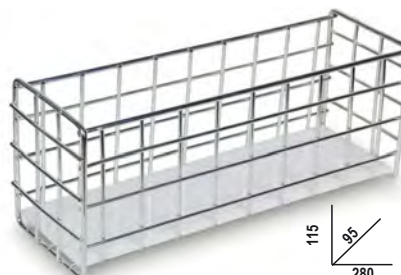

CP € 86,00 1 088880470

SPC

computer wall bracket

- Matches tool wall systems RSC55 and C45PRO
- Dimensions 398x243x138 mm



5 kg



SPC € 69,50 1 088880480

ROLLER CABS & CONTAINERS

LOOSE TOOLS

TRAYS

		N° of pieces	ROLLER CABS & CONTAINERS														
			RSC22	RSC23	RSC23C	RSC23T	RSC24/5	RSC24/6	RSC24/7	RSC24A/7	RSC24/8	RSC24A/8	RSC24AXL/9	C25	C27S	RSRSC28	C30M
without supports	5902MT	Earth moving	106	☐ 462	☐ 462	☐ 462											
	5902MT/AS	Earth moving	99	☐ 463	☐ 463	☐ 463											
	5902VI	Industrial maintenance	107	☐ 429	☐ 429		☐ 429						☐ 429	☐ 429			
	5904VG/3	Car repair	132					☐ 466	☐ 466	☐ 466	☐ 466						
	5905VG/1	Car repair	94										☐ 469				
	5905VG/2	Car repair	118										☐ 470				
	5910VI/3	Industrial maintenance	297														☐ 433
	5954VG	Car repair	138														
	5954VI	Industrial maintenance	133														
	5957U-P	Industrial maintenance	133														
	5957VG	Car repair	174														
	5957VI	Industrial maintenance	162														
5958U	Industrial maintenance	85															
soft modules	5904VG/2M	Car repair	170				☐ 464	☐ 464	☐ 464	☐ 464	☐ 464	☐ 464				☐ 464	
	5904VU/1M	Industrial maintenance	91				☐ 438	☐ 438	☐ 438	☐ 438	☐ 438	☐ 438				☐ 438	
	5904VU/2M	Industrial maintenance	151				☐ 438	☐ 438	☐ 438	☐ 438	☐ 438	☐ 438				☐ 438	
	5927VU/M	Industrial maintenance	108	☐ 448	☐ 448	☐ 448								☐ 448			
	5935ET/1MB	Electrotechnical	96														
	5935VG/1MB	Car repair	98														
	5935VI/2MB	Industrial maintenance	133														
	5945VUM	Industrial maintenance	231														
	5988H/7M	Bicycle and motorcycle repairs	333								☐ 454	☐ 454				☐ 454	
	5988L/4M	Car repair	273					☐ 455	☐ 455	☐ 455	☐ 455	☐ 455					
	5988U6/M	Industrial maintenance	214							☐ 456	☐ 456	☐ 456				☐ 456	
	5988U/7M	Industrial maintenance	215				☐ 444	☐ 444	☐ 444	☐ 444	☐ 444	☐ 444				☐ 444	
	5988VHB-MQ	Electrotechnical	66				☐ 460	☐ 460	☐ 460	☐ 460	☐ 460	☐ 460				☐ 460	
	5904VI/1T	Industrial maintenance	98				☐ 429	☐ 429	☐ 429	☐ 429	☐ 429	☐ 429				☐ 429	
	5904VI/2T	Industrial maintenance	153				☐ 430			☐ 430	☐ 430	☐ 430				☐ 430	
	5904VI/3T	Industrial maintenance	142								☐ 431	☐ 431				☐ 431	
	5904VG/2T	Car repair	99				☐ 465	☐ 465	☐ 465	☐ 465	☐ 465	☐ 465				☐ 465	
	5904VG/3T	Car repair	102				☐ 467	☐ 467	☐ 467	☐ 467	☐ 467	☐ 467				☐ 467	
	5904VG/5T	Car repair	153				☐ 468		☐ 468	☐ 468	☐ 468	☐ 468				☐ 468	
	5904VU/2T	Industrial maintenance	104				☐ 439	☐ 439	☐ 439	☐ 439	☐ 439	☐ 439				☐ 439	
	5904VU/3T	Industrial maintenance	146				☐ 440	☐ 440	☐ 440	☐ 440	☐ 440	☐ 440				☐ 440	
	5904VU/4T	Industrial maintenance	197				☐ 441	☐ 441	☐ 441	☐ 441	☐ 441	☐ 441					
	5908VG/2T	Car repair	212														☐ 471
	5908VI/2T	Industrial maintenance	232								☐ 432	☐ 432				☐ 432	
	5908VU/2T	Industrial maintenance	161				☐ 442		☐ 442	☐ 442	☐ 442	☐ 442				☐ 442	
	5910VG/3T	Car repair	202														☐ 472
5910VI/3T	Industrial maintenance	261														☐ 434	
5938U/2T	Industrial maintenance	210															

5902VI

assortment of 107 tools

► Industrial maintenance

Quantity/Description

- 6 pin punches Ø 2 - 3 - 4 - 5 - 6 - 8 mm
- 1 centre punch Ø 3 mm
- 1 flat chisels, ribbed type 200 mm
- 26 combination wrenches 6÷32 mm
- 12 double open end wrenches 6x7 - 8x9 - 10x11 - 12x13 - 14x15 - 16x17 - 18x19 - 20x22 - 21x23 - 24x26 - 25x28 - 30x32 mm
- 9 offset hexagon key wrenches Ø 1,5 - 2 - 2,5 - 3 - 4 - 5 - 6 - 8 - 10 mm
- 1 adjustable wrench 300 mm
- 13 1/2" square drive hexagon sockets with rail Ø 10÷22 mm
- 1 1/2" drive extension bar 125 mm
- 1 1/2" drive extension bar 255 mm
- 1 1/2" drive universal joint
- 1 1/2" drive sliding T-handle
- 1 1/2" drive reversible ratchet Ⓞ
- 1 Slip joint pliers boxed joints 250 mm
- 1 self - locking pliers 240 mm
- 1 heavy duty diagonal cutting nippers, bi-material handles, industrial finish 160 mm
- 1 compound leverage shears, straight blades 250 mm
- 1 electrician's scissors, straight blades
- 1 heavy duty combination pliers, bi-material handles, industrial finish 180 mm
- 1 extra-long needle knurled nose pliers, bi-material handles, industrial finish 160 mm
- 8 screwdrivers for slotted head screws ● 2,5x50 - 3x75 - 3,5x100 - 4x125 - 5,5x125 - 6,5x150 - 8x200 - 10x200 mm
- 4 screwdrivers for cross head Phillips® screws ⊕ PH0x60 - PH1x80 - PH2x100 - PH3x150 mm
- 1 engineer's hammer 500 g
- 1 dead blow hammer Ø 40 mm
- 1 engineer's scriber
- 1 measuring tape 5 m
- 1 metric feeler gauge
- 5 Set of 5 second-cut files, with handles 200 mm
- 1 hacksaw frame, aluminium handle
- 1 metal oil can 300 cc
- 1 snap - off blade utility knife
- 1 magnetic, articulated lamp with high-brightness LEDs

Beta N.	
31	
32	
35	
42/S26	
55/S12	
96N/SC9	
111	
920A/SB13	
920/21	
920/22	
920/25	
920/42	
920/55	
1048	
1052	
1084GBM	
1122	
1128BMX	
1150GBM	
1166GBM	
1260	
1262	
1370	
1392	
1688A	
1692	
1708/20	
1719BMA - S5	
1726BM	
1751	
1771BM	
1837F	



€

5902VI 1.565,00 059021060

Assortment recommended in combination with RSC22 - RSC23 - RSC23T - C25 - C27S

5904VI/1T

assortment of 98 tools in ABS thermoformed trays

► Industrial maintenance

Quantity/Description

- 19 1/2" square drive hexagon sockets Ø 10÷24 - 26 - 27 - 30 - 32 mm
- 5 1/2" drive, socket drivers for hexagon screws Ø 5 - 6 - 8 - 10 - 12 mm
- 1 1/2" drive extension bar 125 mm
- 1 1/2" drive extension bar 255 mm
- 1 1/2" drive universal joint
- 1 1/2" drive sliding T-handle
- 1 1/2" drive reversible ratchet Ⓞ
- 16 combination wrenches 6÷21 mm
- 5 combination wrenches 22-24-27-30-32 mm
- 1 Slip joint pliers boxed joints 250 mm
- 1 self - locking pliers 240 mm
- 1 Heavy-duty diagonal cutting nippers 160 mm
- 1 half-round needle nose pliers 180 mm
- 1 Extra-long needle nose pliers 160 mm
- 1 circlip pliers straight, internal Ø 180 mm
- 1 circlip pliers bent, internal Ø 170 mm
- 1 circlip pliers straight, external ● 175 mm
- 1 circlip pliers bent, external ● 175 mm
- 2 flat chisels, ribbed type 100 - 200 mm
- 5 second cut files 200 mm
- 1 engineer's hammer 300 g
- 1 soft face hammer Ø 35 mm
- 8 double open end wrenches 6x7 - 8x9 - 10x11 - 12x13 - 14x15 - 16x17 - 18x19 - 20x22 mm
- 9 offset hexagon key wrenches Ø 1,5 - 2 - 2,5 - 3 - 4 - 5 - 6 - 8 - 10 mm
- 4 screwdrivers for slotted head screws ● 3x75 - 4x100 - 5,5x150 - 6,5x150 mm
- 3 screwdrivers for cross head Phillips® screws ⊕ PH0x60 - PH1x80 - PH2x100 mm
- 6 T-handle wrenches with hexagon male ends Ø 2,5 - 3 - 4 - 5 - 6 - 8 mm

Beta N.	TR
920A	T80
920ME	T80
920/21	T80
920/22	T80
920/25	T80
920/42	T80
920/55	T80
42	T05
42	T06
1048	T153
1052	T153
1084	T138
1150	T138
1166	T138
1032	T145
1034	T145
1036	T145
1038	T145
35	T234
1719BMA8/S5	T236
1370	T234
1390	T234
55	T33
96/SC9	T33
1260	T208
1262	T208
951	T68



T80 T05 T06



T153 T138 T145 T236



T234 T33 T208 T68

€

5904VI/1T 1.435,00 059041161

Assortment recommended in combination with RSC24 - RSC24A - RSC24AXL - C37 - C39 with 6 - 7 - 8 drawers
RSC23T - C39T - RSC24L - RSC24L-CAB - C59 - C55 - RSC28 - C39MD - C39SM

5904VI/2T

assortment of 153 tools in ABS thermoformed trays

► Industrial maintenance

Quantity/Description

- 16 combination wrenches 6÷21 mm
- 5 combination wrenches 22 - 24 - 27 - 30 - 32 mm
- 5 pin punches Ø 2 - 3 - 4 - 5 - 6 mm
- 1 centre punch Ø 4 mm
- 12 double open end wrenches 6x7 - 8x9 - 10x11 - 12x13 - 14x15 - 16x17
18x19 - 20x22 - 21x23 - 24x26 - 27x29 - 30x32 mm
- 9 offset hexagon key wrenches \odot 1,5 - 2 - 2,5 - 3 - 4 - 5 - 6 - 8 - 10 mm
- 7 double ended offset ring wrenches 6÷29 mm
- 19 1/2" square drive hexagon sockets \odot 10÷24 - 26 - 27 - 30 - 32 mm
- 1 1/2" drive extension bar 125 mm
- 1 1/2" drive extension bar 255 mm
- 1 1/2" drive universal joint
- 1 1/2" drive sliding T-handle
- 1 1/2" drive reversible ratchet \oplus
- 13 1/4" hexagon sockets \odot 4÷14 mm
- 6 1/4" socket drivers for hexagon screws \odot 2,5÷8 mm
- 1 1/4" drive extension bar 50 mm
- 1 1/4" drive extension bar 150 mm
- 1 1/4" drive universal joint
- 1 1/4" drive spinner handle
- 1 1/4" drive swivel T-handle
- 1 1/4" reversible ratchet \oplus
- 9 screwdrivers for slotted head screws \bullet 3x75 - 3x100 - 4x100 - 4x150 - 5,5x100 - 5,5x150 - 6,5x150 - 8x150 - 10x200 mm
- 2 screwdrivers for slotted head screws, extra-short series \bullet 4x30 - 6,5x30 mm
- 7 screwdrivers for cross head Phillips® screws \oplus PH0x60 - PH0x100 - PH1x80 - PH1x120 - PH2x100 - PH2x150 - PH3x150 mm
- 2 screwdrivers for cross head Phillips® screws, extra - short series \oplus PH1x30 - PH2x30 mm
- 1 Slip joint pliers boxed joints 250 mm
- 1 self - locking pliers 240 mm
- 1 Heavy-duty diagonal cutting nippers \sphericalangle 160 mm
- 1 Extra-long needle nose pliers \bullet 160 mm
- 1 half-round needle nose pliers \equiv 180 mm
- 1 circlip pliers straight, internal \odot 180 mm
- 1 circlip pliers bent, internal \odot 170 mm
- 1 circlip pliers straight, external \bullet 175 mm
- 1 circlip pliers bent, external \bullet 175 mm
- 6 T-handle wrenches with hexagon male ends \odot 2,5 - 3 - 4 - 5 - 6 - 8 mm
- 5 second cut files 200 mm
- 2 flat chisels, ribbed type 100 - 200 mm
- 1 engineer's hammer 300 g
- 1 soft face hammer Ø 35 mm
- 1 riveting pliers
- 100 aluminium rivets 2,9x6 mm
- 100 aluminium rivets 3,2x8 mm
- 100 aluminium rivets 3,8x10 mm
- 100 aluminium rivets 4x12 mm
- 100 aluminium rivets 4,8x12 mm
- 1 measuring tape
- 1 mini hacksaw frame
- 1 plastic oil bottle
- 1 snap - off blade utility knife

Beta N.	TR
42	T05
42	T06
31	T31
32	T31
55	T31
96N/SC9	T31
90	T40
920A	T83
920/21	T83
920/22	T83
920/25	T83
920/42	T83
920/55	T83
900	T91
900ME	T91
900/20	T91
900/21	T91
900/25	T91
900B/G/30	T91
900/42	T91
900/55	T91
1260	T167
1260N	T167
1262	T168
1262N	T168
1048	T153
1052	T153
1084	T138
1166	T138
1150	T138
1032	T145
1034	T145
1036	T145
1038	T145
951	T68
1719BMA8/S5	T236
35	T234
1370	T234
1390	T234
1741B	T281
1741RV...K	T281
1741RV...K	T281
1741RV...K	T281
1741RV...K	T281
1741RV...K	T281
1692	T289
1725CR	T289
1755	T289
1771	T289

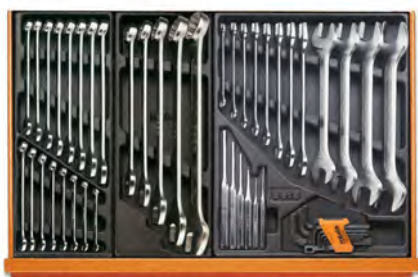

T05 T06 T31



T40 T83 T91



T167 T168



T153 T138 T145 T68



T236 T234 T281 T289

€

5904VI/2T 2.010,00 059041164

Assortment recommended in combination with RSC24 with 7 - 8 drawers - RSC24A with 7 - 8 drawers - C37 with 7 - 8 drawers - RSC24AXL - C39 with 7 - 8 drawers RSC24L - RSC24L-CAB - C59 - C55 - RSC23T - RSC28 - C39MO - C39SM

5904VI/3T

assortment of 142 tools in ABS thermoformed trays

► Industrial maintenance

Quantity/Description

- 16 combination wrenches 6÷21 mm
- 5 combination wrenches 22 - 24 - 27 - 30 - 32 mm
- 5 pin punches Ø 2 - 3 - 4 - 5 - 6 mm
- 1 centre punch Ø 4 mm
- 12 double open end wrenches 6x7 - 8x9 - 10x11 - 12x13 - 14x15 - 16x17 - 18x19 - 20x22 - 21x23 - 24x26 - 27x29 - 30x32 mm
- 9 offset hexagon key wrenches ⌀ 1,5 - 2 - 2,5 - 3 - 4 - 5 - 6 - 8 - 10 mm
- 9 screwdrivers for slotted head screws ● 3x75 - 3,5x100 - 4x100 - 4x150 - 5,5x100 - 5,5x150 - 6,5x150 - 8x150 - 10x200 mm
- 2 screwdrivers for slotted head screws, extra-short series ● 4x30 - 6,5x30 mm
- 6 screwdrivers for cross head Phillips® screws ● PH0x60 - PH0x100 - PH1x80 - PH1x120 - PH2x100 - PH2x150 mm
- 7 drivers for Torx® head screws ○ T6-T7-T8-T9-T10-T15-T20
- 5 1/2" drive, socket drivers for hexagon screws ○ 5 - 6 - 8 - 10 - 12 mm
- 1 1/2" drive extension bar 125 mm
- 1 1/2" drive extension bar 255 mm
- 1 1/2" drive universal joint
- 1 1/2" drive sliding T-handle
- 1 1/2" drive reversible ratchet Ⓢ
- 19 1/2" square drive hexagon sockets ○ 10÷24 - 26 - 27 - 30 - 32 mm
- 8 double ended bi-hex tubular socket wrenches 6x7 - 8x9 - 10x11 - 12x13 - 14x15 - 16x17 - 18x19 - 20x22 mm
- 1 tommy bars for tubular wrenches
- 1 tommy bars for tubular wrenches
- 6 T-handle wrenches with hexagon male ends ○ 2,5 - 3 - 4 - 5 - 6 - 8 mm
- 1 half-round needle nose pliers = 180 mm
- 1 Extra-long needle nose pliers ● 160 mm
- 1 Heavy-duty diagonal cutting nippers < 160 mm
- 1 Slip joint pliers boxed joints 250 mm
- 1 self - locking pliers 240 mm
- 1 circlip pliers straight, internal ○ 180 mm
- 1 circlip pliers bent, internal ○ 170 mm
- 1 circlip pliers straight, external ● 175 mm
- 1 circlip pliers bent, external ● 175 mm
- 1 circlip pliers straight, internal ○ 140 mm
- 1 circlip pliers bent, internal ○ 225 mm
- 1 circlip pliers straight, external ● 140 mm
- 1 circlip pliers bent, external ● 225 mm
- 1 engineer's hammer 400 g
- 1 soft face hammer Ø 35 mm
- 1 second cut files 200 mm
- 1 second cut files 200 mm
- 1 second cut files 200 mm
- 1 digital vernier
- 1 flexible graduated rule 300 mm
- 1 measuring tape 5 m
- 1 riveting pliers 250 mm
- 100 aluminium rivets 2,9x6 mm
- 100 aluminium rivets 3,2x8 mm
- 100 aluminium rivets 3,8x10 mm
- 100 aluminium rivets 4x12 mm
- 100 aluminium rivets 4,8x12 mm
- 1 tin snips 250 mm
- 1 electrician's scissors, straight blades
- 1 hacksaw frame, aluminium handle
- (5) blades for hacksaw
- 1 plastic oil can 200 cc
- empty thermoformed tray

Beta N.	TR
42	T05
42	T06
31	T31
32	T31
55	T31
96N/SC9	T31
1260	T167
1260N	T167
1262	T202
1267TX	T205
920ME	T80
920/21	T80
920/22	T80
920/25	T80
920/42	T80
920/55	T80
920A	T80
930	T73
940/1	T73
940/2	T73
951	T68
1150BM	T137
1166BM	T137
1084BM	T137
1048	T153
1052	T153
1032	T145
1034	T145
1036	T145
1038	T145
1032	T146
1034	T146
1036	T146
1038	T146
1038	T146
1370	T231
1390	T231
1719BMA8/T	T231
1719BMA8/P	T231
1719BMA8/M	T231
1651DGT	T297
1682	T297
1691BM	T297
1741B	T281
1741RV..K	T281
1741RV..K	T281
1741RV..K	T281
1741RV..K	T281
1741RV..K	T281
1112	T285
1128BM	T285
1726	T285
1728BM	T285
1753	T285
VP6	VP6



T05 T06 T31



T167 T202 T205



T80 T73 T68



T137 T153 T145 T146



T231 T297 T281



T285 VP6

€

5904VI/3T 2.330,00 059041168

Assortment recommended in combination with RSC24 with 8 drawers - RSC24/A with 8 drawers - C37 with 8 drawers - C39 with 8 drawers - RSC24AXL with 8-9 drawers - RSC28 - C39MO - C39SM - C55 - C59B

5908VI/2T

assortment of 232 tools in ABS thermoformed trays

► Industrial maintenance

Quantity/Description

- 5 1/2" drive, socket drivers for hexagon screws \odot 5 - 6 - 8 - 10 - 12 mm
- 1 1/2" drive extension bar 125 mm
- 1 1/2" drive extension bar 255 mm
- 1 1/2" drive universal joint
- 1 1/2" drive sliding T-handle
- 1 1/2" drive reversible ratchet ⊗
- 19 1/2" square drive hexagon sockets \odot 10+24 - 26 - 27 - 30 - 32 mm
- 16 combination wrenches 6+21 mm
- 5 combination wrenches 22 - 24 - 27 - 30 - 32 mm
- 13 1/4" hexagon sockets \odot 4+14 mm
- 6 1/4" socket drivers for hexagon screws \odot 2,5 - 3 - 4 - 5 - 6 - 8 mm
- 1 1/4" drive extension bar 50 mm
- 1 1/4" drive extension bar 150 mm
- 1 1/4" drive spinner handle
- 1 1/4" drive universal joint
- 1 1/4" drive swivel T-handle
- 1 1/4" reversible ratchet ⊗
- 6 T-handle wrenches with hexagon male ends \odot 2,5 - 3 - 4 - 5 - 6 - 8 mm
- 2 double ended offset ring wrenches 6x7-8x9-10x11-12x13-14x15-16x17-18x19 mm
- 5 double ended offset ring wrenches 20x22 - 21x23 - 24x26 - 25x28 - 27x29 mm
- 7 screwdrivers for slotted head screws \bullet 2,5x50 - 3x75 - 3,5x100 - 4x125 - 5,5x100 - 5,5x150 - 6,5x150 mm
- 6 screwdrivers for cross head Phillips® screws \oplus PH0x60 - PH0x100 - PH1x80 - PH1x120 - PH2x100 - PH2x150 mm
- 3 screwdrivers for slotted head screws \bullet 8x200 - 10x150 - 10x200 mm
- 2 screwdrivers for slotted head screws, extra-short series \bullet 4x30 - 6,5x30 mm
- 2 screwdrivers for cross head Phillips® screws \oplus PH3x150 - PH4x200 mm
- 2 screwdrivers for cross head Phillips® screws, extra - short series \oplus PH1x30 - PH2x30 mm
- 2 flat chisels, ribbed type 100 - 200 mm
- 1 engineer's hammer 300 g
- 1 soft face hammer \varnothing 35 mm
- 1 riveting pliers 250 mm
- 100 aluminium rivets 2,9x6 mm
- 100 aluminium rivets 3,2x8 mm
- 100 aluminium rivets 3,8x10 mm
- 100 aluminium rivets 4x12 mm
- 100 aluminium rivets 4,8x12 mm
- 1 Slip joint pliers boxed joints 250 mm
- 1 self - locking pliers 240 mm
- 5 Set of 5 second-cut files, with handles 200 mm
- 1 circlip pliers straight, internal \odot 180 mm
- 1 circlip pliers bent, internal \odot 170 mm
- 1 circlip pliers straight, external \bullet 175 mm
- 1 circlip pliers bent, external \bullet 175 mm
- 1 half-round needle nose pliers \equiv 180 mm
- 1 Extra-long needle nose pliers \bullet 160 mm
- 1 Heavy-duty diagonal cutting nippers \llcorner 160 mm
- 5 pin punches \varnothing 2 - 3 - 4 - 5 - 6 mm
- 1 centre punch \varnothing 4 mm
- 12 double open end wrenches 6x7 - 8x9 - 10x11 - 12x13 - 14x15 - 16x17 - 18x19 - 20x22 - 21x23 - 24x26 - 27x29 - 30x32 mm
- 9 offset hexagon key wrenches \odot 1,5 - 2 - 2,5 - 3 - 4 - 5 - 6 - 8 - 10 mm
- 1 tin snips 250 mm
- 1 electrician's scissors, straight blades
- 1 hacksaw frame, aluminium handle
- 5 blades for hacksaw
- 1 plastic oil can 200 cc
- 1 empty thermoformed tray
- 1 adjustable tap wrench M3+M12
- 1 adjustable tap wrench M5+M21
- 1 reversible ratcheting tap wrench 2,0+5,0 mm (M3+M8)
- 1 reversible ratcheting tap wrench 4,6+8,0 mm (M5+M12)
- 1 die stock 25,4 mm
- 1 die stock 38,1 mm
- 1 screw pitch gauge 0,25+6 W 62+4x1"
- 26 coarse pitch hand taps M3 - 4 - 5 - 6 - 7 - 8 - 9 - 10 - 12 - 14 - 16 - 18 - 20
- 14 fine pitch hand taps M6x0,75 - M8x1 - M10x1,25 - M12x1,5 - M14x1,5 - M16x1,5 - M18x1,5
- 7 round dies, coarse pitch M3 - 4 - 5 - 6 - 7 - 8 - 9
- 6 round dies, coarse pitch M10 - 12 - 14 - 16 - 18 - 20
- 2 round dies, fine pitch M6x0,75 - M8x0,75
- 5 round dies, fine pitch M10x1,25 - M12x1,5 - M14x1,5 - M16x1,5 - M18x1,5

Beta N.	TR
920ME	T80
920/21	T80
920/22	T80
920/25	T80
920/42	T80
920/55	T80
920A	T80
42	T05
42	T06
900	T91
900ME	T91
900/20	T91
900/21	T91
900BG/30	T91
900/25	T91
900/42	T91
900/55	T91
951	T68
90	T40
90	T41
1260	T199
1262	T202
1260	T201
1260N	T201
1262	T204
1262N	T204
35	T234
1370	T234
1390	T234
1741B	T281
1741RV...K	T281
1741RV...K	T281
1741RV...K	T281
1741RV...K	T281
1741RV...K	T281
1048	T153
1052	T153
1719BMA...S5	T236
1032	T145
1034	T145
1036	T145
1038	T145
1150BM	T137
1166BM	T137
1084BM	T137
31	T31
32	T31
55	T31
96N/SC9	T31
1112	T285
1128BM	T285
1726	T285
1728BM	T285
1753	T285
VP5	VP5
435/1,5	T273
435/3	T273
436/1	T273
436/2	T273
444/1	T273
444/2	T273
1707	T273
430	T270
433	T270
440	T270
440A	T270
441	T270
441A	T270



T80 T05 T06



T91 T68 T40 T41



T199 T202 T201 T204



T234 T281 T153 T236



T145 T137 T31



T285 VP5



T273 T270

€

5908VI/2T

3.070,00 059081105

Assortment recommended in combination with RSC28 - RSC24AXL with 8 and 9 drawers - RSC24A with 8 and 9 drawers - RSC24 with 8 drawers - C37 with 8 drawers - C39 with 8 drawers



5910VI/3

assortment of 297 tools

► Industrial maintenance

Quantity/Description	Beta N.
6 Ø 2 - 3 - 4 - 5 - 6 - 8 mm	31/B6N
1 centre punch Ø 4 mm	32
2 flat chisels, ribbed type 125 - 250 mm	35
1 cape chisel, ribbed type 200 mm	37
30 combination wrenches 6-7-8-9-10-11-12-13-14-15-16-17-18-19-20-21-22-23-24-25-26-27-28-29-30-32-35-36-38-41 mm	42
14 double open end wrenches 6x7 - 8x9 - 10x11 - 12x13 - 14x15 - 16x17 - 18x19 - 20x22 - 21x23 - 24x26 - 25x28 - 27x29 - 30x32 - 36x41 mm	55
13 double ended offset ring wrenches 6x7+30x32 mm	90
14 offset hexagon key wrenches Ø 1,5 - 2 - 2,5 - 3 - 4 - 5 - 6 - 8 - 10 - 12 - 13 - 14 - 17 - 19 mm	96N
1 adjustable wrench 250 mm	111
1 heavy duty pipe wrench 300 mm	362
25 twist drills with cylindrical shanks, short series 1+13x0,5 mm	412/SP25
37 assortment of HSS taps and dies, metric thread	447/C37
1 click-type torque wrenches with reversible ratchets @ 1/2", 40+200 Nm	666N/20
1 1/2" drive swivel T-handle	920/40
4 1/2" drive, socket drivers for hexagon screws Ø 10-12-14-17 mm	920ME
25 20 sockets and 5 accessories	920A/C20X
17 assortment of 12 sockets and 5 accessories 3/4"	928A/C12
12 double ended hexagon/bi - hex offset socket wrenches 8 - 10 - 11 - 13 - 14 - 17 - 19 - 22 - 24 - 27 - 30 - 32 mm	932
14 T-handle wrenches with hexagon male ends 2+14 mm	951/S14
5 T handle wrenches with swivelling hexagon male ends Ø 3 - 4 - 5 - 6 - 8 mm	953
3 circlip pliers straight, internal Ø 180 - 225 - 300 mm	1032
3 circlip pliers bent, internal Ø 170 - 210 - 290 mm	1034
3 circlip pliers straight, external ● 140x1,3 - 175 - 225 mm	1036
3 circlip pliers bent, external ● 135x1,3 - 175 - 220 mm	1038
2 Slip joint pliers boxed joints 250 - 300 mm	1048
1 self locking pliers, double adjustment	1051
1 heavy duty diagonal cutting nippers, bi-material handles, industrial finish ⚡ 160 mm	1084GBM
1 toggle lever assisted end cutting nippers ⚡ 180 mm	1092V
1 tin snips 300 mm	1112
1 tin snip, straight narrow blades 250 mm	1114
1 electrician's scissors, straight blades	1128BMX
1 heavy duty combination pliers, bi-material handles, industrial finish ■ 180 mm	1150GBM
1 extra-long needle knurled nose pliers, bi-material handles, industrial finish ● 160 mm	1166GBM
1 extra-long bent needle knurled nose pliers, bi-material handles, industrial finish ● 160 mm	1168GBM
9 screwdrivers for slotted head screws ● 2,5x50 - 3x75 - 3,5x150 - 4x125 - 5,5x125 - 6,5x150 - 8x200 - 10x200 - 12x250 mm	1260
2 screwdrivers for slotted head screws, extra-short series ● 4x30 - 6,5x30 mm	1260N
5 screwdrivers for cross head Phillips® screws ⊕ PH0x100 - PH1x120 - PH2x150 - PH3x150 - PH4x200 mm	1262
2 screwdrivers for cross head Phillips® screws, extra - short series ⊕ PH1x30 - PH2x30 mm	1262N
7 drivers for Torx® head screws ⊖ T6 - T8 - T10 - T15 - T20 - T25 - T30	1267TX
2 engineer's hammer 300 - 600 g	1370
2 soft face hammer Ø 35 - 60 mm	1390
5 tapered extractors M3+M18	1430/S5
1 two - leg universal puller 23+70 mm	1500N/1
1 two - leg universal puller 23+100 mm	1500N/2
1 sliding gauge	1650
1 semirigid stainless steel rule 300 mm	1683
1 engineer's scribe	1688A
1 measuring tape 5 m	1692
1 metric feeler gauge	1708/13
1 flexible magnetic pick-up tool 1,8 kg	1712E/2
5 second cut files 200 mm	1719BMA8/S5
1 hacksaw frame, aluminium handle	1726BM
1 riveting pliers	1741B
1 metal oil can 200 cc	1751

€

5910VI/3 6.370,00 059101044

Assortment recommended for use with item C30M

5910VI/3T

assortment of 261 tools in ABS thermoformed trays

► Industrial maintenance

Quantity/Description

- 16 combination wrenches 6÷21 mm
- 5 combination wrenches 22 - 24 - 27 - 30 - 32 mm
- 5 pin punches Ø 2 - 3 - 4 - 5 - 6 mm
- 1 centre punch Ø 4 mm
- 13 double open end wrenches 6x7 - 8x9 - 10x11 - 12x13 - 14x15 - 16x17
18x19 - 20x22 - 21x23 - 24x26 - 27x29 - 30x32 mm
- 9 offset hexagon key wrenches Ø 1,5 - 2 - 2,5 - 3 - 4 - 5 - 6 - 8 - 10 mm
- 5 double ended offset ring wrenches 20x22 - 21x23 - 24x26 - 25x28 - 27x29 mm
- 7 double ended offset ring wrenches 6x7 - 8x9 - 10x11 - 12x13 - 14x15 - 16x17 - 18x19 mm
- 5 1/2" drive, socket drivers for hexagon screws Ø 5 - 6 - 8 - 10 - 12 mm
- 1 1/2" drive extension bar 125 mm
- 1 1/2" drive extension bar 255 mm
- 1 1/2" drive universal joint
- 1 1/2" drive sliding T-handle
- 1 1/2" drive reversible ratchet
- 19 1/2" square drive hexagon sockets Ø 10÷24 - 26 - 27 - 30 - 32 mm
- 9 screwdrivers for slotted head screws ● 3x75 - 3x100 - 4x100 - 4x150 - 5,5x100 - 5,5x150 - 6,5x150 - 8x150 - 10x200 mm
- 2 screwdrivers for slotted head screws, extra-short series ● 4x30 - 6,5x30 mm
- 7 screwdrivers for cross head Phillips® screws ⚙ PH0x60 - PH0x100 - PH1x80 - PH1x120 - PH2x100 - PH2x150 - PH3x150 mm
- 2 screwdrivers for cross head Phillips® screws, extra - short series ⚙ PH1x30 - PH2x30 mm
- 4 offset hexagon key wrenches Ø 13-14-17-19 mm
- 1 tin snips 250 mm
- 1 electrician's scissors, straight blades
- 1 hacksaw frame, aluminium handle
- (5) blades for hacksaw
- 1 plastic oil can 200 cc
- 1 half-round needle nose pliers = 180 mm
- 1 Extra-long needle nose pliers ● 160 mm
- 1 Heavy-duty diagonal cutting nippers ≲ 160 mm
- 1 circlip pliers straight, internal ○ 180 mm
- 1 circlip pliers bent, internal ○ 170 mm
- 1 circlip pliers straight, external ● 175mm
- 1 circlip pliers bent, external ● 175mm
- 2 flat chisels, ribbed type 100 - 200 mm
- 1 engineer's hammer 300 g
- 1 soft face hammer Ø 35 mm
- 1 second cut files 200 mm
- 4 combination wrenches 35-36-38-41 mm
- 1 double open end wrenches 36x41 mm
- 1 adjustable wrench 250 mm
- 1 heavy duty pipe wrench 300 mm
- 25 twist drills with cylindrical shanks, short series
- 37 assortment of HSS taps and dies, metric thread
- 1 click-type torque wrenches with reversible ratchets @ 200 Nm
- 17 assortment of 12 sockets and 5 accessories 3/4"
- 14 T-handle wrenches with hexagon male ends
- 5 T handle wrenches with swivelling hexagon male ends Ø 3-4-5-6-8 mm
- 1 circlip pliers straight, internal ○ 300 mm
- 1 circlip pliers bent, internal ○ 290 mm
- 1 circlip pliers straight, external ● 225 mm
- 1 circlip pliers bent, external ● 220 mm
- 1 Slip joint pliers boxed joints 300 mm
- 1 self locking pliers, double adjustment
- 1 toggle lever assisted end cutting nippers ≲ 180 mm
- 1 engineer's hammer 600 g
- 1 soft face hammer 60 mm
- 5 tapered extractors M3-M18
- 1 two - leg universal puller
- 1 sliding gauge
- 1 semirigid stainless steel rule
- 1 engineer's scriber
- 1 measuring tape 5 m
- 1 metric feeler gauge
- 1 flexible magnetic pick-up tool

Beta N.	TR
42	T05
42	T06
31	T31
32	T31
55	T31
96N/SC9	T31
90	T41
90	T40
920ME	T80
920/21	T80
920/22	T80
920/25	T80
920/42	T80
920/55	T80
920A	T80
1260	T167
1260N	T167
1262	T168
1262N	T168
96N	T168
1112	T285
1128BM	T285
1726	T285
1728BM	T285
1753	T285
1150BM	T137
1166BM	T137
1084BM	T137
1032	T145
1034	T145
1036	T145
1038	T145
35	T234
1370	T234
1390	T234
1719BMA8/S5	T236
42	
55	
111	
362	
412/SP25	
447/C37	
666N/20	
928A/C12	
951/S14	
953	
1032	
1034	
1036	
1038	
1048	
1051	
1092V	
1370	
1390	
1430/S5	
1500/3	
1650	
1683	
1688	
1692	
1708/13	
1712E/2	



T05 T06 T31



T40 T41 T80



T167 T168 +96N



T137 T145 T285 T234 T236



€

5910VI/3T

5.440,00 059101063

Assortment recommended for use with item C30M

5935VI/2MB

assortment of 133 tools for tool chest C35, in EVA foam trays

► Industrial maintenance

Quantity/Description

- 21 combination wrenches 6-7-8-9-10-11-12-13-14-15-16-17-18-19-20-21-22-24-27-30-32 mm
- 8 double open end wrenches 6x7-8x9-10x11-12x13-14x15
16x17-18x19-20x22 mm
- 1 Slip joint pliers boxed joints 250 mm
- 19 1/2" square drive hexagon sockets ○ 10-11-12-13-14-15-16-17-18-19-20-21-22-23-24-26-27-30-32 mm
- 1 1/2" wobble extension bar 125 mm
- 1 1/2" wobble extension bar 150 mm
- 1 1/2" drive universal joint
- 1 1/2" drive sliding T-handle
- 1 1/2" drive reversible ratchet ⊕
- 1 adjustable wrench 250 mm
- 1 self - locking pliers 240 mm
- 1 Heavy-duty diagonal cutting nippers < 160 mm
- 1 half-round needle nose pliers = 180 mm
- 1 Extra-long needle nose pliers ● 160 mm
- 1 circlip pliers straight, internal ○ 180 mm
- 1 circlip pliers bent, internal ○ 170 mm
- 1 circlip pliers straight, external ● 175 mm
- 1 circlip pliers bent, external ● 175 mm
- 13 1/4" hexagon sockets ○ 4-4,5-5-5,5-6-7-8-9-10-11-12-13-14 mm
- 1 1/4" drive extension bar 50 mm
- 1 1/4" drive extension bar 150 mm
- 1 1/4" drive universal joint
- 1 1/4" drive spinner handle
- 1 1/4" reversible ratchet ⊕
- 1 1/4" drive swivel T-handle
- 7 screwdrivers for slotted head screws
● 2,5x50-3x75-3,5x100-4x100-5,5x125-6,5x150-8x200 mm
- 2 screwdrivers for slotted head screws, extra-short series ● 4x30-6,5x30 mm
- 7 screwdrivers for cross head Phillips® screws ⊕ PH0x60-PH0x100-PH1x80-PH1x120-PH2x100-PH2x150-PH3x150 mm
- 2 screwdrivers for cross head Phillips® screws, extra - short series ⊕ PH1x30-PH2x30 mm
- 1 mains testing screwdriver ● 4x30-6,5x30 mm
- 9 ball head offset hexagon key wrenches ○
- 6 T-handle wrenches with hexagon male ends ○ 2,5-3-4-5-6-8 mm
- 5 pin punches Ø 2-3-4-5-6 mm
- 1 centre punch Ø 4 mm
- 1 flat chisels, ribbed type 200 mm
- 1 tin snips 250 mm
- 1 electrician's scissors, straight blades
- 1 engineer's hammer 500 g
- 1 soft face hammer Ø 45 mm
- 1 second-cut square files 200 mm
- 1 second-cut triangular files 200 mm
- 1 second-cut flat files 200 mm
- 1 second-cut half-round files 200 mm
- 1 second-cut round files 200 mm
- 1 hacksaw frame, aluminium handle 440 mm

Beta N.	TR
42	MB12
55	MB12
1048	MB12
920A	MB37
920AN/125	MB37
920AN/250	MB37
920/25	MB37
920/42	MB37
920/55	MB37
111	MB37
1052	MB37
1084BM	MB37
1150BM	MB37
1166BM	MB37
1032	MB37
1034	MB37
1036	MB37
1038	MB37
900	MB37
900/20	MB37
900/21	MB37
900/25	MB37
900BG/30	MB37
900/55	MB37
900/42	MB37
1260	MB44
1260N	MB44
1262	MB44
1262N	MB44
1253	MB44
96BPC/SC9	MB44
951	MB44
31	MB55
32	MB55
35	MB55
1112	MB55
1128BMX	MB55
1370	MB55
1390	MB55
1719BMA...Q	MB55
1719BMA...T	MB55
1719BMA...P	MB55
1719BMA...M	MB55
1719BMA...R	MB55
1726	MB55



MB12



MB37

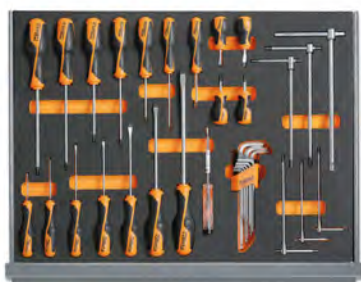

MB44



MB55

€

5935VI/2MB 1.945,00 059351316

Assortment recommended in combination with C35



5957VI

Assortment of 162 tools

► Industrial maintenance

Quantity/Description	Beta N.
6 pin punches Ø 2 - 3 - 4 - 5 - 6 - 8 mm	31/SP6
6 2 drift punches, 1 centre punch, 3 flat chisels with metal holder	38/SP6
18 combination wrenches 6-7-8-10-11-12-13-14-15-16-17-19-21-22-24-27-30-32 mm	42
12 double open end wrenches 6x7 ÷ 30x32 mm	55/S12X
8 offset hexagon key wrenches 2 - 2,5 - 3 - 4 - 5 - 6 - 8 - 10 mm	96T/S8
8 offset key wrenches, for Torx® head screws Ⓢ T9 - T10 - T15 - T20 - T25 - T27 - T30 - T40	97TX/SC8
1 adjustable wrench 250 mm	111
13 1/2" square drive bi-hex sockets with rail Ⓞ 10+22 mm	920B/SB13
8 1/2" square drive bi-hex sockets with rail Ⓞ 23+32 mm	920B/SB8
4 1/2" socket drivers for slotted head screws ● 1,2x6,5 - 1,2x8 - 1,6x9 - 2x12 mm	920LP
3 1/2" socket drivers for Phillips® screws Ⓢ PH2 - 3 - 4	920PH
1 1/2" drive extension bar 125 mm	920/21
1 1/2" drive extension bar 255 mm	920/22
1 1/2" drive universal joint	920/25
1 1/2" drive sliding T-handle	920/42
1 1/2" drive reversible ratchet Ⓢ	920/55
1 pry bar	963
2 circlip pliers straight, internal Ⓞ 140 - 180 mm	1032
2 circlip pliers bent, internal Ⓞ 130 - 170 mm	1034
2 circlip pliers straight, external ● 140 - 175 mm	1036
2 circlip pliers bent, external ● 135 - 175 mm	1038
1 Slip joint pliers boxed joints 250 mm	1048
1 self locking pliers, double adjustment	1051
1 Heavy-duty diagonal cutting nippers ⚡ 160 mm	1084BM
1 toggle lever assisted end cutting nippers ⚡ 180 mm	1092V
1 tin snips 250 mm	1112
1 tin snip, straight narrow blades 250 mm	1114
1 electrician's scissors, straight blades	1128BMX
1 half-round needle nose pliers = 180 mm	1150BM
1 Extra-long needle nose pliers ● 160 mm	1166BM
1 Extra-long bent needle nose pliers ● 160 mm	1168BM
7 screwdrivers for slotted head screws ● 2,5x50 - 3x75 - 4x100 5,5x125 - 6,5x150 - 8x200 - 10x200 mm	1260
4 screwdrivers for cross head Phillips® screws Ⓢ PH0x60 - PH1x80 - PH2x100 - PH3x150 mm	1262
3 engineer's hammer 300 - 600 - 1000 g	1370
1 soft face hammer Ø 35 mm	1390
1 measuring tape 5 m	1692
1 flexible magnetic pick-up tool 1,8 kg	1712E/2
1 two cutting edges scraper 200 mm	1717A
1 three - cutting edges scraper 200 mm	1717B
5 second cut files 200 mm	1719BMA8/S5
1 hacksaw frame, aluminium handle	1725
1 metal oil can 200 cc	1751
1 flat chisels, ribbed type 200 mm	35
1 cape chisel, ribbed type 200 mm	37
11 double ended hexagon/bi - hex offset socket wrenches 8 - 10 - 11 - 12 - 13 - 14 - 16 - 17 - 19 - 22 - 24 mm	932
1 self - locking pliers 240 mm	1052
1 self - locking pliers 280 mm	1060
1 self - locking pliers 290 mm	1062
1 dead blow hammer Ø 50 mm	1392
1 two - leg universal puller 25+130 mm	1500N/2
1 sliding gauge	1650
1 semirigid stainless steel rule 300 mm	1683
1 engineer's scriber	1688A
1 metric feeler gauge	1708/13
1 fold - away knife	1777BM
1 snap - off blade utility knife 170 mm	1771BM
1 Diagonal cutting nippers ⚡ 160 mm	1082BM

€ 

5957VI 3.180,00 059571005

Assortment recommended in combination with C57S A - C57S B - C57SP - C55PSP

5954VI

Assortment of 133 tools

► Industrial maintenance

Quantity/Description	Beta N.
5 pin punches Ø 2-3-4-5-6 mm	31
1 centre punch Ø 4 mm	32
2 flat chisels, ribbed type 200-250 mm	35
18 combination wrenches 6÷14 - 16 - 17 - 18 - 19 21 - 22 - 24 - 27 - 30 mm	42
12 double open end wrenches 6x7 - 8x9 - 10x11 - 12x13 - 14x15 - 16x17 18x19 - 20x22 - 21x23 - 24x26 - 27x29 - 30x32 mm	55
12 offset hexagon key wrenches Ø 2÷10 mm	96/SC12
1 adjustable wrench 250 mm	111
1 pipe wrench Swedish pattern 320 mm	374
20 1/2" square drive hexagon sockets Ø 10÷24 - 26 - 27 - 28 - 30 - 32 mm	920A
6 1/2" drive, socket drivers for hexagon screws Ø 5 - 6 - 8 - 10 - 12 - 14 mm	920ME
1 1/2" drive extension bar 125 mm	920/21
1 1/2" drive extension bar 255 mm	920/22
1 1/2" drive universal joint	920/25
1 1/2" drive swivel T-handle	920/40
1 1/2" drive sliding T-handle	920/42
1 1/2" drive reversible ratchet	920/55
6 T-handle wrenches with hexagon male ends Ø 2,5 - 3 - 4 - 5 - 6 - 8 mm	951
2 circlip pliers straight, internal Ø 140 - 180 mm	1032
1 circlip pliers bent, internal Ø 170 mm	1034
2 circlip pliers straight, external Ø 140x1,3 - 175 mm	1036
1 circlip pliers bent, external Ø 175 mm	1038
1 Slip joint pliers boxed joints 250 mm	1048
1 self - locking pliers 240 mm	1052
1 Heavy-duty diagonal cutting nippers 160 mm	1084BM
1 toggle lever assisted end cutting nippers 180 mm	1092V
1 tin snips 250 mm	1112
1 electrician's scissors, straight blades	1128BMX
1 half-round needle nose pliers 180 mm	1150BM
1 Extra-long needle nose pliers 160 mm	1166BM
1 mains testing screwdriver	1253
2 screwdrivers for slotted head screws 8x150 - 10x200 mm	1260
2 screwdrivers for slotted head screws, extra-short series 4x30 - 6,5x30 mm	1260N
2 screwdrivers for cross head Phillips® screws PH3x150 - PH4x200 mm	1262
2 screwdrivers for cross head Phillips® screws, extra - short series PH1x30 - PH2x30 mm	1262N
8 set of screwdrivers	1263/D8
2 engineer's hammer 300 - 500 g	1370
1 soft face hammer Ø 45 mm	1390
1 measuring tape 5 m	1692
1 flexible magnetic pick-up tool 0,5 kg	1712E/1
5 second cut files 200 mm	1719BMA8/S5
1 hacksaw frame, aluminium handle	1726BM
1 plastic oil can 250 cc	1754



€ 

5954VI 2.185,00 059541053

Assortment recommended in combination with C54S-C55C



5904VU/1M

assortment of 91 tools in EVA foam trays

► Universal use

Quantity/Description

- 16 combination wrenches 6÷21 mm
- 8 double open end wrenches 6x7 - 8x9 - 10x11 - 12x13 - 14x15 - 16x17 - 18x19 - 20x22 mm
- 9 offset hexagon key wrenches \odot 1,5 - 2 - 2,5 - 3 - 4 - 5 - 6 - 8 - 10 mm
- 7 screwdrivers for slotted head screws \bullet 2,5x50 - 3x75 - 3,5x100 - 4x125 - 5,5x100 - 5,5x150 - 6,5x150 mm
- 6 screwdrivers for cross head Phillips® screws \oplus PH0x60 - PH0x100 - PH1x80 - PH1x120 - PH2x100 - PH2x150 mm
- 8 offset hexagon key wrenches \odot 2-2,5-3-4-5-6-7-8 mm
- 1 1/2" wobble extension bar 125 mm
- 1 1/2" wobble extension bar 250 mm
- 1 1/2" drive universal joint
- 1 1/2" drive sliding T-handle
- 1 1/2" drive reversible ratchet \oplus
- 19 1/2" square drive hexagon sockets \odot 10÷24 - 26 - 27 - 30 - 32 mm
- 1 Heavy-duty diagonal cutting nippers ∇ 160 mm
- 1 half-round needle nose pliers \equiv 180 mm
- 1 Extra-long needle nose pliers \bullet 160 mm
- 1 Slip joint pliers boxed joints 250 mm
- 1 self - locking pliers 240 mm
- 2 flat chisels, ribbed type 100 - 200 mm
- 1 engineer's hammer 300 g
- 1 soft face hammer \emptyset 35 mm
- 1 circlip pliers straight, internal \odot 180 mm
- 1 circlip pliers bent, internal \odot 170 mm
- 1 circlip pliers straight, external \bullet 175 mm
- 1 circlip pliers bent, external \bullet 175 mm

Beta N.	TR
42	M05
55	M33
96/SC9	M33
1260	M199
1262	M202
96T	M50
920AN/125	M83
920AN/250	M83
920/25	M83
920/42	M83
920/55	M83
920A	M83
1084	M137
1150	M137
1166	M137
1048	M153
1052	M153
35	M234
1370	M234
1390	M234
1032	M145
1034	M145
1036	M145
1038	M145



M05 M33 M199 M202



M50 M83



M137 M153 M234 M145

€

5904VU/1M 1.235,00 059041201

Assortment recommended in combination with RSC24 - RSC24A - RSC24AXL - C37 - C39 with 6 - 7 - 8 drawers
RSC23T - C39T - RSC24L - RSC24L-CAB - C59 - C55 - RSC28 - C39SM - C39MD



5904VU/2M

assortment of 151 tools in EVA foam trays

► Universal use

Quantity/Description

- 16 combination wrenches 6÷21 mm
- 8 double open end wrenches 6x7 - 8x9 - 10x11 - 12x13 - 14x15 - 16x17 - 18x19 - 20x22 mm
- 9 offset hexagon key wrenches \odot 1,5 - 2 - 2,5 - 3 - 4 - 5 - 6 - 8 - 10 mm
- 7 screwdrivers for slotted head screws \bullet 2,5x50 - 3x75 - 3,5x100 - 4x125 - 5,5x100 - 5,5x150 - 6,5x150 mm
- 6 screwdrivers for cross head Phillips® screws \oplus PH0x60 - PH0x100 - PH1x80 - PH1x120 - PH2x100 - PH2x150 mm
- 8 offset hexagon key wrenches \odot 2-2,5-3-4-5-6-7-8 mm
- 1 1/2" wobble extension bar 125 mm
- 1 1/2" wobble extension bar 250 mm
- 1 1/2" drive universal joint
- 1 1/2" drive sliding T-handle
- 1 1/2" drive reversible ratchet \oplus
- 19 1/2" square drive hexagon sockets \odot 10÷24 - 26 - 27 - 30 - 32 mm
- 1 Heavy-duty diagonal cutting nippers ∇ 160 mm
- 1 half-round needle nose pliers \equiv 180 mm
- 1 Extra-long needle nose pliers \bullet 160 mm
- 1 Slip joint pliers boxed joints 250 mm
- 1 self - locking pliers 240 mm
- 2 flat chisels, ribbed type 100 - 200 mm
- 1 mechanic's hammers 300 g
- 1 nylon face hammers, wooden shafts \emptyset 35 mm
- 1 circlip pliers straight, internal \odot 180 mm
- 1 circlip pliers bent, internal \odot 170 mm
- 1 circlip pliers straight, external \bullet 175 mm
- 1 circlip pliers bent, external \bullet 175 mm
- 6 drivers for Torx® head screws \odot T8-T10-T15-T20-T25-T30
- 1 measuring tape 5 m
- 1 mini hacksaw frame
- 1 plastic oil bottle 30 cc
- 1 snap - off blade utility knife
- 5 bits for slotted head screws, coloured \bullet 0,5x3 - 0,6x4,5 - 0,8x5,5 - 1x5,5 - 1,2x6,5 mm
- 8 hexagon bits for power drivers, coloured \odot 2 - 2,5 - 3 - 4 - 5 - 6 - 8 - 10 mm
- 5 bits for cross head Phillips® screws, coloured \oplus PH0 - PH1 - PH2 - PH3 - PH4
- 4 bits for cross head Pozidriv® - Supadriv® screws, coloured \oplus PZ1 - PZ2 - PZ3 - PZ4
- 11 bits for Torx® head screws, coloured \odot T6-T7-T8-T9-T10-T15-T20-T25-T27-T30-T40
- 8 bits for Tamper Resistant Torx® head screws, coloured \oplus T9-T10-T15-T20-T25-T27-T30-T40
- 1 magnetic bit holder with handle 230 mm
- 1 reversible bit ratchet 100 mm
- 5 second cut files 200 mm
- 1 adaptors for drivers
- 1 magnetic bit holder extension bar

Beta N.	TR
42	M05
55	M33
96/SC9	M33
1260	M199
1262	M202
96T	M50
920AN/125	M83
920AN/250	M83
920/25	M83
920/42	M83
920/55	M83
920A	M83
1084	M137
1150	M137
1166	M137
1048	M153
1052	M153
35	M237
1370T	M237
1390N	M237
1032	M145
1034	M145
1036	M145
1038	M145
1267TX	M204
1692	M289
1725CR	M289
1755	M289
1771	M289
860LP	M85
860PE	M85
860PH	M85
860PZ	M85
860TX	M85
860RTX	M85
851SR	M85
860/55	M85
1719BMA8/S5	M236
892/0	M85
882P	M85

€

5904VU/2M 1.640,00 059041202

Assortment recommended in combination with RSC24 - RSC24A - C37 - C39
RSC24L - RSC24L-CAB - C59 - C55 - C23 - RSC28 - C39SM - C39MD - C39T

5904VU/2T

assortment of 104 tools in ABS thermoformed trays

► Universal use

Quantity/Description

- 7 screwdrivers for slotted head screws ● 2,5x50 - 3x75 - 3,5x100 - 4x125
5,5x100 - 5,5x150 - 6,5x150 mm
- 6 screwdrivers for cross head Phillips® screws ● PH0x60 - PH0x100 - PH1x80 - PH1x120 - PH2x100 - PH2x150 mm
- 19 1/2" square drive hexagon sockets ○ 10-11-12-13-14-15-16-17-18-19
20-21-22-23-24-26-27-30-32 mm
- 1 1/2" drive extension bar 125 mm
- 1 1/2" drive extension bar 255 mm
- 1 1/2" drive universal joint
- 1 1/2" drive sliding T-handle 305 mm
- 1 1/2" drive reversible ratchet ⊕
- 1 circlip pliers straight, internal ○ 180 mm
- 1 circlip pliers bent, internal ○ 170 mm
- 1 circlip pliers straight, external ● 175 mm
- 1 circlip pliers bent, external ● 175 mm
- 1 Slip joint pliers boxed joints 250 mm
- 1 self - locking pliers 240 mm
- 1 Heavy-duty diagonal cutting nippers † 160 mm
- 1 half-round needle nose pliers = 180 mm
- 1 Extra-long needle nose pliers ● 160 mm
- 2 flat chisels, ribbed type 100-200 mm
- 1 engineer's hammer 300 g
- 1 soft face hammer Ø 35 mm
- 6 T-handle wrenches with hexagon male ends ○ 2,5-3-4-5-6-8 mm
- 8 double open end wrenches 6x7-8x9-10x11-12x13-14x15
16x17-18x19-20x22 mm
- 9 offset hexagon key wrenches ○ 1,5÷10 mm
- 16 combination wrenches 6-7-8-9-10-11-12-13-14-15-16-17
18-19-20-21 mm
- 5 combination wrenches 22-24-27-30-32 mm
- 1 electrician's scissors, straight blades
- 1 Multiuse scissors
- 1 second-cut square files 200 mm
- 1 second-cut flat files 200 mm
- 1 second-cut triangular files 200 mm
- 1 second-cut half-round files 200 mm
- 1 second-cut round files 200 mm
- 1 hacksaw frame, aluminium handle
- 1 blades for hacksaw
- 1 snap - off blade utility knife 170 mm
- 1 foldaway knife 185 mm

Beta N.	TR
1260	T199
1262	T202
920A	T83
920/21	T83
920/22	T83
920/25	T83
920/42	T83
920/55	T83
1032	T145
1034	T145
1036	T145
1038	T145
1048	T153
1052	T153
1084	T138
1150	T138
1166	T138
35	T234
1370	T234
1390	T234
951	T68
55	T33
96/SC9	T33
42	T05
42	T06
1128BMX	T284
1130BMX	T284
1719BMA...Q	T284
1719BMA...P	T284
1719BMA...T	T284
1719BMA...M	T284
1719BMA...R	T284
1726BM	T284
1728BM	T284
1771BM	T284
1778	T284



T199 T202 T83



T145 T153 T138 T234

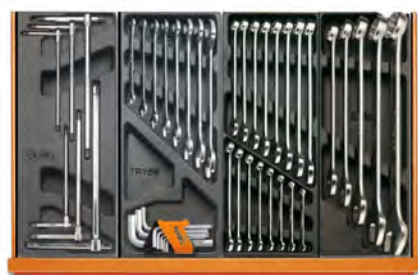

T68 T33 T05 T06



T284

5904VU/2T € 1.545,00 059041070

Assortment recommended in combination with RSC24 - RSC24A - C37 - C39
RSC24L - RSC24L-CAB - C59 - C55 - RSC23T - RSC28 - C39SM - C39MD - C39T

5904VU/3T

assortment of 146 tools in ABS thermoformed trays

► Universal use

Quantity/Description

- 16 combination wrenches 6+21 mm
- 5 combination wrenches 22 - 24 - 27 - 30 - 32 mm
- 5 pin punches Ø 2 - 3 - 4 - 5 - 6 mm
- 1 centre punch Ø 4 mm
- 12 double open end wrenches 6x7 - 8x9 - 10x11 - 12x13 - 14x15 - 16x17 - 18x19 - 20x22 - 21x23 - 24x26 - 27x29 - 30x32 mm
- 9 offset hexagon key wrenches \odot 1,5 - 2 - 2,5 - 3 - 4 - 5 - 6 - 8 - 10 mm
- 6 offset hexagon key wrenches \odot 2 - 2,5 - 3 - 4 - 5 - 6 mm
- 6 drivers for Torx® head screws, with handles \odot T10-T15-T20-T25-T27-T30
- 5 1/2" drive, socket drivers for hexagon screws \odot 5 - 6 - 8 - 10 - 12 mm
- 1 1/2" drive extension bar 125 mm
- 1 1/2" drive extension bar 255 mm
- 1 1/2" drive universal joint
- 1 1/2" drive sliding T-handle
- 1 1/2" drive reversible ratchet \odot
- 19 1/2" square drive hexagon sockets \odot 10+24 - 26 - 27 - 30 - 32 mm
- 13 1/4" hexagon sockets \odot 4-4,5-5-5,5-6-7-8-9-10-11-12-13-14 mm
- 6 1/4" socket drivers for hexagon screws \odot 2,5-3-4-5-6-8 mm
- 1 1/4" drive extension bar 50 mm
- 1 1/4" drive extension bar 150 mm
- 1 1/4" drive universal joint
- 1 1/4" drive spinner handle
- 1 1/4" drive swivel T-handle 115 mm
- 1 1/4" reversible ratchet \odot
- 1 circlip pliers straight, internal \odot 180 mm
- 1 circlip pliers bent, internal \odot 170 mm
- 1 circlip pliers straight, external \odot 175 mm
- 1 circlip pliers bent, external \odot 175 mm
- 1 half-round needle nose pliers \equiv 180 mm
- 1 Extra-long needle nose pliers \bullet 160 mm
- 1 Heavy-duty diagonal cutting nippers ∇ 160 mm
- 1 Slip joint pliers boxed joints 250 mm
- 1 self - locking pliers 240 mm
- 4 screwdrivers for slotted head screws \bullet 3x75 - 4x100 - 5,5x150 - 6,5x150 mm
- 3 screwdrivers for cross head Pozidriv®-Supadriv® screws \oplus PZ0 - PZ1 - PZ2
- 7 drivers for Torx® head screws \odot T6-T7-T8-T9-T10-T15-T20
- 2 flat chisels, ribbed type 100 - 200 mm
- 1 engineer's hammer 300 g
- 1 soft face hammer Ø 35 mm
- 5 second cut files 200 mm

Beta N.	TR
42	T05
42	T06
31	T31
32	T31
55	T31
96N/SC9	T31
96T	T52
97TTX	T55
920ME	T80
920/21	T80
920/22	T80
920/25	T80
920/42	T80
920/55	T80
920A	T80
900	T91
900ME	T91
900/20	T91
900/21	T91
900/25	T91
900BG/30	T91
900/42	T91
900/55	T91
1032	T145
1034	T145
1036	T145
1038	T145
1150	T138
1166	T138
1084	T138
1048	T153
1052	T153
1260	T198
1269PZ	T198
1267TX	T205
35	T234
1370	T234
1390	T234
1719BMA8/S5	T236



T05 T06 T31



T52 T55 T80



T91 T145 T138 T153



T198 T205 T234 T236

€

5904VU/3T

1.870,00 059041203

Assortment recommended in combination with RSC24 - RSC24A - C37 - C39
RSC24L - RSC24L-CAB - C59 - C55 - C39T - C39SM - C39MD - RSC23T - RSC28

5904VU/4T

assortment of 197 tools in ABS thermoformed trays

► Universal use

Quantity/Description

- 1 drift punches Ø 4 mm
- 1 pin punches Ø 4 mm
- 1 centre punch Ø 4 mm
- 54 assortment of 52 hexagon bits, 10 mm, and 2 accessories
- 17 combination wrenches 6-7-8-10-11-12-13-14-16-17-18-19-21-22-24-27-30 mm
- 7 double ended offset ring wrenches 6x7-8x9-10x11-12x13-14x15-16x17-18x19 mm
- 19 1/2" square drive hexagon sockets ○ 10-11-12-13-14-15-16-17-18-19-20-21-22-23-24-26-27-30-32 mm
- 1 1/2" drive extension bar 125 mm
- 1 1/2" drive extension bar 250 mm
- 1 1/2" drive universal joint
- 1 1/2" drive sliding T-handle 305 mm
- 1 1/2" drive reversible ratchet Ⓢ
- 13 1/4" hexagon sockets ○ 4-4,5-5-5,5-6-7-8-9-10-11-12-13-14 mm
- 6 1/4" socket drivers for hexagon screws ○ 2,5-3-4-5-6-8 mm
- 1 1/4" drive extension bar 50 mm
- 1 1/4" drive extension bar 150 mm
- 1 1/4" drive universal joint
- 1 1/4" drive spinner handle
- 1 1/4" drive swivel T-handle 115 mm
- 1 1/4" reversible ratchet Ⓢ
- 1 Diagonal cutting nippers ⚡ 160 mm
- 1 half-round needle nose pliers = 180 mm
- 1 Slip joint pliers boxed joints 250 mm
- 7 screwdriver for slotted head screws ● 2,5x50 - 3x75 - 3,5x100 - 4x125 - 5,5x100 - 5,5x150 - 6,5x150 mm
- 6 screwdriver for cross head Phillips® screws ⊕ PH0x60 - PH1x80 - PH1x120 - PH2x100 - PH2x150 - PH3x150 mm
- 7 screwdrivers for Torx® head screws, with handles ⊕ T6-T7-T8-T9-T10-T15-T20
- 2 flat chisels, ribbed type 100-200 mm
- 1 engineer's hammer 300 g
- 1 soft face hammer Ø 35 mm
- 7 ball head offset hexagon key wrenches burnished ○ 2,5-3-4-5-6-8-10 mm
- 1 offset hexagon key wrenches ○ 12 mm
- 31 bits with magnetic quick release bit holder in plastic case ● ○ ⊕ ⊕ ⊕ ⊕
- 1 socket holder

Beta N.	TR
	30
	31
	32
867/C52	42
	90
920A	90
	920/21
	920/22
	920/25
	920/42
	920/55
	900
900ME	900
900/20	900
900/21	900
900/25	900
900BG/30	900
900/42	900
900/55	900
	1082
	1150
	1048
1201E	1048
	1202E
1207E/TX	1202E
	35
	1370
	1390
	96BP
	96N
860MIX/A31	96N
	895/1



T01

T83



T91

T156

T40

T211



T213

T216

T234

T259

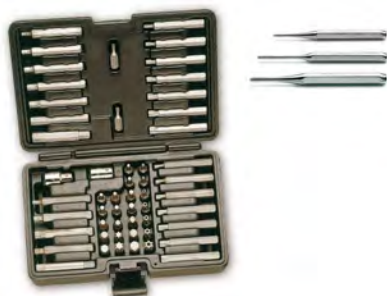

5904VU/4T

€ 1.460,00 059241100

Assortment recommended in combination with items RSC23T - RSC24 - RSC24A - RSC24AXL - RSC24L - RSC24L-CAB - C37 - C39 - C39T - C39SM - C39MD - RSC55 - C59

5908VU/2T

assortment of 161 tools in ABS thermoformed trays

► Universal use

Quantity/Description



T05 T06 T31



T40 T52 T55 T91



T82 T138 T153



T145 T170 T171 T172



T173 T234 T236 VP4

Quantity/Description	Beta N.	TR
16 combination wrenches 6+21 mm	42	T05
5 combination wrenches 22 - 24 - 27 - 30 - 32 mm	42	T06
5 pin punches Ø 2 - 3 - 4 - 5 - 6 mm	31	T31
1 centre punch Ø 4 mm	32	T31
12 double open end wrenches 6x7 - 8x9 - 10x11 - 12x13 - 14x15 - 16x17 18x19 - 20x22 - 21x23 - 24x26 - 27x29 - 30x32 mm	55	T31
9 offset hexagon key wrenches ⌀ 1,5 - 2 - 2,5 - 3 - 4 - 5 - 6 - 8 - 10 mm	96N/SC9	T31
7 double ended offset ring wrenches 6x7-8x9-10x11-12x13-14x15-16x17-18x19 mm	90	T40
6 offset hexagon key wrenches ⌀ 2-2,5-3-4-5-6 mm	96T	T52
6 drivers for Torx® head screws, with handles Ⓢ T10-T15-T20-T25-T27-T30	97TTX	T55
19 1/2" square drive hexagon sockets Ⓢ 10-11-12-13-14 15-16-17-18-19-20-21-22-23-24-26-27-30-32 mm	920A	T82
5 1/2" drive, socket drivers for hexagon screws Ⓢ 5-6-8-10-12 mm	920ME	T82
1 1/2" wobble extension bar 125 mm	920AN/125	T82
1 1/2" wobble extension bar 250 mm	920AN/250	T82
1 1/2" drive universal joint	920/25	T82
1 1/2" drive sliding T-handle 305 mm	920/42	T82
1 1/2" drive reversible ratchet Ⓢ	920/55	T82
13 1/4" hexagon sockets Ⓢ 4-4,5-5-5,5-6-7-8-9-10-11-12-13-14 mm	900	T91
6 1/4" socket drivers for hexagon screws Ⓢ 2,5-3-4-5-6-8 mm	900ME	T91
1 1/4" drive extension bar 50 mm	900/20	T91
1 1/4" drive extension bar 150 mm	900/21	T91
1 1/4" drive universal joint	900/25	T91
1 1/4" drive spinner handle	900BG/30	T91
1 1/4" drive swivel T-handle 115 mm	900/42	T91
1 1/4" reversible ratchet Ⓢ	900/55	T91
1 Heavy-duty diagonal cutting nippers ⚡ 160 mm	1084	T138
1 half-round needle nose pliers = 180 mm	1150	T138
1 Extra-long needle nose pliers ● 160 mm	1166	T138
1 circlip pliers straight, internal Ⓢ 180 mm	1032	T145
1 circlip pliers bent, internal Ⓢ 170 mm	1034	T145
1 circlip pliers straight, external ● 175 mm	1036	T145
1 circlip pliers bent, external ● 175 mm	1038	T145
1 Slip joint pliers boxed joints 250 mm	1048	T153
1 self - locking pliers 240 mm	1052	T153
7 screwdrivers for cross head Phillips® screws ● 2,5x50-3x75-3,5x100-4x125-5,5x100-5,5x150- 6,5x150 mm	1290	T170
3 screwdrivers for cross head Phillips® screws ● 8x150-8x200-10x200 mm	1290	T171
2 screwdriver for slotted head screws, extra-short series ● 4x30-6,5x30 mm	1292	T172
6 screwdrivers for cross head Phillips® screws Ⓢ PH0x60-PH0x100-PH1x80-PH1x120- PH2x100-PH2x150 mm	1292	T173
2 screwdrivers for cross head Phillips® screws Ⓢ PH3x150-PH4x200 mm	1292N	T173
2 screwdriver for cross head Phillips® screws, extra-short series Ⓢ PH1x30-PH2x30 mm	35	T234
2 flat chisels, ribbed type 100-200 mm	1370	T234
1 engineer's hammer 300 g	1390	T234
1 soft face hammer Ø 35 mm	1719BMA...Q	T236
1 second-cut square files 200 mm	1719BMA...T	T236
1 second-cut triangular files 200 mm	1719BMA...P	T236
1 second-cut flat files 200 mm	1719BMA...M	T236
1 second-cut half-round files 200 mm	1719BMA...R	T236
1 second-cut round files 200 mm	VP4	

€

5908VU/2T

2.120,00 059081136

Assortment recommended in combination with items RSC23T - RSC24, 6-7-8 drawers - RSC24A - RSC24AXL - RSC24L - RSC24L-CAB - RSC28 C37, 6-7-8 drawers - C39, 6-7-8 drawers - C39MD - C39SM - C59 - RSC55

5914VU/M

assortment of 109 tools for trolley C14, in EVA foam trays



MC T1



MC T2



MC T3

► Universal use

Quantity/Description

- 31 bits with magnetic quick release bit holder in plastic case ① ○ ⊕ ⊕ ⊕ ⊕
- 1 socket holder
- 13 1/4" hexagon sockets ○ 4-4,5-5,5-6-7-8-9-10-11-12-13-14 mm
- 1 1/4" drive extension bar 150 mm
- 1 1/4" drive universal joint
- 1 1/4" drive spinner handle
- 1 1/4" drive swivel T-handle
- 1 1/4" reversible ratchet ⊕
- 16 1/2" square drive hexagon sockets ○ 10-11-12-13-14-15-16-17-18-19-21-22-24-27-30-32 mm
- 1 1/2" drive universal joint
- 1 1/2" wobble extension bar
- 1 1/2" drive sliding T-handle
- 1 1/2" drive reversible ratchet ⊕
- 16 combination wrenches 6-7-8-9-10-11-12-13-14-15-16-17-18-19-21-22 mm
- 9 offset hexagon key wrenches ○
- 1 adjustable wrench 250 mm
- 1 electrician's scissors, straight blades
- 1 measuring tape 5 mt
- 1 snap - off blade utility knife
- 1 Slip joint pliers boxed joints 250 mm
- 1 Diagonal cutting nippers 160 mm
- 1 half-round needle nose pliers = 180 mm
- 1 Extra-long needle nose pliers ● 160 mm
- 3 screwdrivers for slotted head screws ● 3,5x100-5,5x125-6,5x150 mm
- 3 screwdrivers for cross head Phillips® screws ⊕ PHx60-PH1x80-PH3x100 mm

Beta N.	TR
860MIX/A31	MCT1
895/1	MCT1
900	MCT1
900/...	MCT1
900/25	MCT1
900BG/30C	MCT1
900/42	MCT1
900/55	MCT1
920A	MCT1
920/25	MCT1
920AN/125	MCT1
920/42	MCT1
920/55	MCT1
42	MCT2
96/SC9	MCT2
111	MCT2
1128BMX	MCT2
1692/5	MCT2
1771	MCT2
1048	MCT3
1082BM	MCT3
1150BM	MCT3
1166BM	MCT3
1260	MCT3
1262	MCT3

5914VU/M € 1.016,00 059140112

Assortment recommended in combination with C14

5988U/7M

assortment of 215 tools in EVA foam trays

► Universal use

Quantity/Description



M01



M100



M213



M33

M86

M136

M234

Quantity/Description	Beta N.	TR
22 combination wrenches 6-7-8-9-10-11-12-13-14-15-16-17-18-19-20-21-22-24-27-30-32-36 mm	42	M01
8 double open end wrenches 6x7-8x9-10x11-12x13-14x15-16x17-18x19-20x22 mm	55	M33
9 offset hexagon key wrenches \odot 1,5+10 mm	96/SC9	M33
7 hexagon bits \odot 4-5-6-7-8-10-12 mm	867PE	M86
7 hexagon bits \odot 4-5-6-7-8-10-12 mm	867PEL	M86
5 bits with XZN [®] profile \odot 5-6-8-10-12 mm	867XZN	M86
5 bits with XZN [®] profile \odot 5-6-8-10-12 mm	867XZNL	M86
7 bits for Torx [®] head screws \odot T20-T25-T30-T40-T45-T50-T55	867TX	M86
6 bits for Torx [®] head screws \odot T25-T30-T40-T45-T50-T55	867TXL	M86
7 bits for Tamper Resistant Torx [®] head screws \oplus T20-T25-T30-T40-T45-T50-T55	867RTX	M86
1 bit holder sockets for item 867	867/1	M86
1 bit holder sockets for item 867	867/2	M86
1 socket holder	895/1	M100
1 socket holder	895/3	M100
1 socket holder	895/6	M100
13 1/4" hexagon sockets \odot 4-4,5-5-5,5-6-7-8-9-10-11-12-13-14 mm	900	M100
9 hexagon hand sockets, long series \odot 5-6-7-8-9-10-11-12-13 mm	900L	M100
5 1/4" socket drivers for hexagon screws \odot 3-4-5-6-7 mm	900ME	M100
4 socket drivers for slotted head screws \bullet 0,8x4-1x5,5-1,2x6,5-1,2x8 mm	900LP	M100
4 socket drivers for cross head Phillips [®] screws \oplus PH1-PH2-PH3-PH4	900PH	M100
7 socket drivers for Torx [®] head screws \odot T10-T15-T20-T25-T27-T30-T40	900TX	M100
1 1/4" drive extension bar 50 mm	900/20	M100
1 1/4" drive extension bar 100 mm	900/20L	M100
1 1/4" drive extension bar 150 mm	900/21	M100
1 1/4" drive universal joint	900/25	M100
1 1/4" drive spinner handle	900BG/30	M100
1 1/4" drive swivel T-handle	900/42	M100
1 1/4" reversible ratchet \oplus	900/55	M100
21 1/2" square drive hexagon sockets \odot 8-10-11-12-13-14-15-16-17-18-19-20-21-22-23-24-26-27-28-30-32 mm	920A	M100
1 adaptor, 1/2" female and 3/8" male drives	920/15	M100
1 1/2" drive universal joint	920/25	M100
1 1/2" wobble extension bar 125 mm	920AN/125	M100
1 1/2" wobble extension bar 250 mm	920AN/250	M100
1 1/2" drive sliding T-handle	920/42	M100
1 1/2" drive reversible ratchet \oplus	920/55	M100
8 1/2" sockets for Torx [®] head screws \odot 10-12-14-16-18-20-22-24 mm	920FTX	M100
11 hexagon hand sockets \odot 10-12-13-14-15-16-17-18-19-21-22	920AL	M100
1 Heavy-duty diagonal cutting nippers ∇ 160 mm	1084BM	M136
1 half-round needle nose pliers \equiv 180 mm	1150BM	M136
1 Extra-long needle nose pliers \bullet 160 mm	1166BM	M136
6 screwdriver for slotted head screws \bullet 2,5x50-3x75-4x100-5,5x125-6,5x150-8x200 mm	1201E	M213
1 screwdriver for slotted head screws, extra-short series \bullet 4x30 mm	1201EN	M213
4 screwdriver for cross head Phillips [®] screws \oplus PH0x60-PH1x80-PH2x100-PH3x150 mm	1202E	M213
1 screwdriver for cross head Phillips [®] screws, extra-short series \oplus PH1X30 mm	1202EN	M213
12 screwdrivers for Torx [®] head screws, with handles \odot T6-T7-T8-T9-T10-T15-T20-T25-T27-T30-T40-T45	1207E/TX	M213
1 mains testing screwdriver \bullet	1253	M213
2 flat chisels, ribbed type 100-200 mm	35	M234
1 engineer's hammer 300 g	1370	M234
1 soft face hammer \varnothing 35 mm	1390	M234

€



5988U/7M

2.160,00 059881019

Assortment recommended in combination with items RSC23T - RSC24 - RSC24AXL - RSC24L - RSC24L-CAB - RSC28 - C37 - C39 - C39SM - C39MD - RSC55 - C59

5915VU/0

Assortment of 35 tools

► Universal use

Quantity/Description

- 1 centre punch 4 mm
- 1 flat chisels, ribbed type 125 mm
- 8 double open end wrenches 6x7-8x9-10x11-12x13-14x15-16x17-18x19-20x22 mm
- 7 Offset hexagon key wrenches \odot 1,5-2-2,5-3-4-5-6 mm
- 1 adjustable wrench 150 mm
- 1 Slip joint pliers boxed joints 250 mm
- 1 diagonal cutting nippers, slip-proof double layer PVC coated handles, industrial finish ∇ 160 mm
- 1 electrician's scissors, straight blades
- 1 heavy duty combination pliers, slip-proof double layer PVC coated handles, industrial finish \equiv 180 mm
- 1 extra-long needle knurled nose pliers, slip-proof double layer PVC coated handles, industrial finish \bullet 160 mm
- 4 screwdriver for slotted head screws \bullet 3x75-4x100-5,5x100-6,5x150 mm
- 3 screwdriver for cross head Phillips® screws \oplus PH0x60-PH1x80-PH2x100 mm
- 1 engineer's hammer 300 g
- 1 measuring tape 3 m
- 1 snap - off blade utility knife 18 mm
- 1 car service knife
- 1 high-brightness LED torch, made of sturdy anodized aluminium, up to 500 lumens

Beta N.

- 32
- 35
- 55
- 96/BGS7
- 111
- 1048
- 1082G
- 1128BMX
- 1150G
- 1166G
- 1201E
- 1202E
- 1370
- 1692/3
- 1771
- 1778SOS
- 1833S



€ 

5915VU/0 380,00 059151021

Assortment recommended in combination with C4 - C5 - C5S - C6T

5915VU/1

Assortment of 45 tools

► Universal use

Quantity/Description

- 2 drift punches \varnothing 2-3 mm
- 1 centre punch \varnothing 4 mm
- 2 flat chisels 125-150 mm
- 1 cape chisels, standard type 150 mm
- 14 combination wrenches 6÷14 - 17 - 19 - 21 - 22 - 24 mm
- 9 offset hexagon key wrenches \odot 1,5 - 2 - 2,5 - 3 - 4 - 5 - 6 - 8 - 10 mm
- 1 adjustable wrench 250 mm
- 1 Slip joint pliers boxed joints 250 mm
- 1 diagonal cutting nippers, slip-proof double layer PVC coated handles, industrial finish ∇ 160 mm
- 1 electrician's scissors, straight blades
- 1 heavy duty combination pliers, slip-proof double layer PVC coated handles, industrial finish \equiv 180 mm
- 1 extra-long needle knurled nose pliers, slip-proof double layer PVC coated handles, industrial finish \bullet 160 mm
- 4 screwdriver for slotted head screws \bullet 3x75 - 4x100 - 5,5x100 - 6,5x150 mm
- 3 screwdriver for cross head Phillips® screws \oplus PH0x60 - PH1x80 - PH2x100 mm
- 1 engineer's hammer 300 g
- 1 measuring tape 5 m
- 1 snap - off blade utility knife

Beta N.

- 30
- 32
- 34
- 36
- 42
- 96/SC9
- 111
- 1048
- 1082G
- 1128BMX
- 1150G
- 1166G
- 1201E
- 1202E
- 1370
- 1692
- 1771



€ 

5915VU/1 461,00 059151024

Assortment recommended in combination with C8 - C9 - C10 - C10S - C11 - CP15 - CP15L - C16 - CP17 - CP17L - C18



5915VU/2

Assortment of 49 tools

► Universal use

Quantity/Description

- 8 6x7 - 8x9 - 10x11 - 12x13 - 14x15
16x17 - 18x19 - 20x22 mm
- 9 offset hexagon key wrenches \odot 1,5 - 2 - 2,5 - 3 - 4 - 5 - 6 - 8 - 10 mm
- 13 1/4" hexagon sockets \odot 4 - 4,5 - 5 - 5,5 - 6 - 7 - 8 - 9 - 10 - 11 - 12 - 13 - 14 mm
- 1 1/4" drive extension bar 150 mm
- 1 1/4" drive universal joint
- 1 1/4" drive spinner handle
- 1 1/4" drive swivel T-handle
- 1 1/4" reversible ratchet \otimes
- 1 Slip joint pliers boxed joints 250 mm
- 1 electrician's scissors, straight blades
- 1 heavy duty combination pliers,
slip-proof double layer PVC coated handles,
industrial finish \equiv 180 mm
- 4 screwdriver for slotted head screws \bullet 3x75 - 4x100 - 5,5x150 - 6,5x150 mm
- 3 screwdriver for cross head Phillips® screws \oplus PH0x60 - PH1x80 - PH2x100 mm
- 1 engineer's hammer 300 g
- 1 measuring tape 3 m
- 1 plastic oil bottle 30 cc
- 1 snap - off blade utility knife 18 mm

- Beta N.**
- 55/B8N
 - 96/SC9
 - 900
 - 900/21
 - 900/25
 - 900BG/30
 - 900/42
 - 900/55
 - 1048
 - 1128BMX
 - 1150G
 - 1201E
 - 1202E
 - 1370
 - 1692
 - 1755
 - 1771

5915VU/2

€ 406,00 059151027

Assortment recommended in combination with C7 - CP15 - C20 - C20L



5915VU/3

assortment of 74 tools

► Universal use

Quantity/Description

- 1 pin punches \varnothing 4 mm
- 1 centre punch \varnothing 4 mm
- 1 flat chisels 150 mm
- 14 combination wrenches 6-7-8-10-11-12-13-14-15-16-17-19-22-24 mm
- 9 offset hexagon key wrenches \odot 1,5+10 mm
- 3 offset hexagon key wrenches \odot 4 - 5 - 6 mm
- 1 adjustable wrench 250 mm
- 13 1/2" square drive hexagon sockets \odot 8+17 - 19 - 22 - 24 mm
- 1 1/2" drive extension bar 125 mm
- 1 1/2" drive extension bar 255 mm
- 1 1/2" drive universal joint
- 1 1/2" drive sliding T-handle
- 1 1/2" drive reversible ratchet \otimes
- 8 double ended hexagon tubular socket wrenches, light series
6x7 - 8x9 - 10x11 - 12x13 - 14x15 - 16x17 - 18x19 - 20x22 mm
- 2 tommy bars for tubular wrenches
- 1 slip joint pliers 250 mm
- 1 self - locking pliers 240 mm
- 1 heavy duty diagonal cutting nippers,
slip-proof double layer PVC coated handles,
industrial finish \neq 160 mm
- 1 electrician's scissors, straight blades
- 1 heavy duty combination pliers,
slip-proof double layer PVC coated handles,
industrial finish \equiv 180 mm
- 1 extra-long needle knurled nose pliers,
slip-proof double layer PVC coated handles,
industrial finish \bullet 160 mm
- 4 screwdriver for slotted head screws \bullet 3x75 - 4x100 - 5,5x150 - 6,5x150 mm
- 3 screwdriver for cross head Phillips® screws \oplus PH0x60 - PH1x80 - PH2x100 mm
- 1 engineer's hammer 400 g
- 1 measuring tape 5 m
- 1 hacksaw frame, aluminium handle
- 1 plastic oil bottle 150 cc
- 1 snap - off blade utility knife

- Beta N.**
- 31
 - 32
 - 34
 - 42
 - 96/SC9
 - 96T
 - 111
 - 920A
 - 920/21
 - 920/22
 - 920/25
 - 920/42
 - 920/55
 - 935
 - 940
 - 1048V
 - 1052
 - 1084G
 - 1128BMX
 - 1150G
 - 1166G
 - 1201E
 - 1202E
 - 1370
 - 1692
 - 1726
 - 1755
 - 1771

5915VU/3

€ 850,00 059151028

Assortment recommended in combination with C7 - C9 - C10 - C10S - C11 - CP15L - C16 - CP17 - CP17L - C19 - C19L - C20 - C20L



5915VU/4

Assortment of 80 tools

► Universal use

Quantity/Description

- 1 pin punches Ø 4 mm
- 1 centre punch Ø 4 mm
- 1 flat chisels 150 mm
- 15 combination wrenches 6-7-8-9-10-11-12-13-14-15-16-17-19-22-24 mm
- 9 offset hexagon key wrenches \odot 1,5÷10 mm
- 1 adjustable wrench 250 mm
- 13 1/2" square drive hexagon sockets \odot 8÷17 - 19 - 22 - 24 mm
- 1 1/2" drive extension bar 255 mm
- 1 1/2" drive universal joint
- 1 1/2" drive sliding T-handle
- 1 1/2" drive reversible ratchet \odot
- 17 double ended hexagon/bi - hex offset socket wrenches 6÷22 mm
- 1 Slip joint pliers boxed joints 250 mm
- 1 self - locking pliers 240 mm
- 1 heavy duty diagonal cutting nippers, bi-material handles, industrial finish ∇ 160 mm
- 1 electrician's scissors, straight blades
- 1 heavy duty combination pliers, bi-material handles, industrial finish \equiv 180 mm
- 1 extra-long needle knurled nose pliers, bi-material handles, industrial finish \bullet 160 mm
- 4 screwdriver for slotted head screws \bullet 3x75 - 4x100 - 5,5x150 - 6,5x150 mm
- 3 screwdriver for cross head Phillips® screws \oplus PH0x60 - PH1x80 - PH2x100 mm
- 1 riveting hammer 32 mm
- 1 measuring tape 5 m
- 1 hacksaw frame, aluminium handle
- 1 plastic oil bottle 150 cc
- 1 snap - off blade utility knife

Beta N.

- 31
- 32
- 34
- 42
- 96/SC9
- 111
- 920A
- 920/22
- 920/25
- 920/42
- 920/55
- 932/S17
- 1048
- 1052
- 1084GBM
- 1128BMX
- 1150GBM
- 1166GBM
- 1201E
- 1202E
- 1370F
- 1692
- 1726
- 1755
- 1771

5915VU/4

€ 1.103,00 059151045

Assortment recommended in combination with C20 - C20L



5915VU/5

assortment of 111 tools

► Universal use

Quantity/Description

- 1 pin punches Ø 4 mm
- 1 centre punch Ø 4 mm
- 1 flat chisels 150 mm
- 17 combination wrenches 6-7-8-9-10-11-12-13-14-15-16-17-18-19-20-21-22 mm
- 8 double open end wrenches 6x7-8x9-10x11-12x13-14x15-16x17-18x19-20x22 mm
- 9 ball head offset hexagon key wrenches \odot
- 1 adjustable wrench 250 mm
- 39 11 hexagon sockets, 20 bits and 8 accessories
- 13 11 sockets and 2 accessories
- 1 Slip joint pliers boxed joints 250 mm
- 1 self - locking pliers 240 mm
- 1 diagonal cutting nippers, slip-proof double layer PVC coated handles, industrial finish ∇ 160 mm
- 1 construction worker's pincers 220 mm
- 1 electrician's scissors, straight blades
- 1 heavy duty combination pliers, slip-proof double layer PVC coated handles, industrial finish \equiv 180 mm
- 1 extra-long needle knurled nose pliers, slip-proof double layer PVC coated handles, industrial finish \bullet 160 mm
- 4 screwdriver for slotted head screws \bullet 3x75 - 4x100 - 5,5x100 - 6,5x150 mm
- 3 screwdriver for cross head Phillips® screws \oplus PH0x60 - PH1x80 - PH2x100 mm
- 1 engineer's hammer 300 g
- 1 soft face hammer Ø 35 mm
- 1 measuring tape 3 m
- 1 second cut files
- 1 hacksaw frame, aluminium handle 440 mm
- 1 snap - off blade utility knife 18 mm
- 1 LED inspection torch, made of sturdy anodized aluminium

Beta N.

- 31
- 32
- 34
- 42
- 55/S8
- 96BPC/SC9
- 111
- 900/C11
- 920A/C11
- 1048
- 1052
- 1082G
- 1098
- 1128BMX
- 1150G
- 1166G
- 1201E
- 1202E
- 1370
- 1390
- 1692/3
- 1719BMA8/M
- 1726
- 1771BM
- 1833XS/2

5915VU/5

€ 1.085,00 059151046

Assortment recommended in combination with C12 - C41S - C41H - C42S - C42H



5915VU/AS

assortment of 68 tools

► Universal use

Quantity/Description

- 1 pin punches Ø 4 mm
- 1 centre punch Ø 4 mm
- 1 flat chisels 150 mm
- 13 combination wrenches 1/4 - 5/16 - 3/8 - 7/16 - 1/2 - 9/16 - 5/8 - 11/16 - 3/4 - 13/16 - 7/8 - 15/16 - 1"
- 8 double ended offset ring wrenches 1/4"±1"
- 9 offset hexagon key wrenches, burnished ○ 3/64"±3/8"
- 1 adjustable wrench 250 mm
- 11 1/2" square drive bi - hex sockets ○ 3/8 - 7/16 - 1/2 - 9/16 - 5/8 - 11/16 - 3/4 - 13/16 - 7/8 - 15/16 - 1"
- 1 1/2" drive extension bar 125 mm
- 1 1/2" drive extension bar 255 mm
- 1 1/2" drive universal joint
- 1 1/2" drive sliding T-handle
- 1 1/2" drive reversible ratchet Ⓢ
- 1 Slip joint pliers boxed joints 250 mm
- 1 self - locking pliers 240 mm
- 1 heavy duty diagonal cutting nippers, bi-material handles, industrial finish ⚡ 160 mm
- 1 electrician's scissors, straight blades
- 1 heavy duty combination pliers, bi-material handles, industrial finish ≡ 180 mm
- 1 extra-long needle knurled nose pliers, bi-material handles, industrial finish ● 160 mm
- 4 screwdriver for slotted head screws ● 3x75 - 4x100 - 5,5x150 - 6,5x150 mm
- 3 screwdriver for cross head Phillips® screws ⚡ PH0x60 - PH1x80 - PH2x100 mm
- 1 engineer's hammer 300 g
- 1 measuring tape 5 m
- 1 hacksaw frame, aluminium handle
- 1 plastic oil bottle 150 cc
- 1 snap - off blade utility knife

Beta N.
31
32
34
42AS
90AS/8
96AS/SC9
111
920AS
920/21
920/22
920/25
920/42
920/55
1048
1052
1084GBM
1128BMX
1150GBM
1166GBM
1201E
1202E
1370
1692
1726
1755
1771

€

5915VU/AS 934,00 059151032

Assortment recommended in combination with C10 - C20 - C20L



MC10



MC20

5927VU/M

assortment of 108 tools in EVA foam trays

► Universal use

Quantity/Description

- 16 combination wrenches 6-7-8-9-10-11-12-13-14-15-16-17-18-19-21-22 mm
- 1 Heavy-duty diagonal cutting nippers ⚡ 160 mm
- 9 offset hexagon key wrenches ○ 1,5-2-2,5-3-4-5-6-8-10 mm
- 1 half-round needle nose pliers ≡ 180 mm
- 1 Extra-long needle nose pliers ● 160 mm
- 3 screwdriver for slotted head screws ● 3,5x100-5,5x150-6,5x150 mm
- 3 screwdriver for cross head Phillips® screws ⚡ PH0x3x60-PH1x4,5x80-PH2x6x100 mm
- 31 bits with magnetic quick release bit holder in plastic case ● ○ ⊕ ⊕ ⊕ ⊕
- 1 Slip joint pliers boxed joints 250 mm
- 1 engineer's hammer 300 mm
- 1 centre punch 4 mm
- 1 cape chisels, standard type 4 mm
- 13 1/4" hexagon sockets ○ 4-4,5-5-5,5-6-7-8-9-10-11-12-13-14 mm
- 1 1/4" drive extension bar 150 mm
- 1 1/4" drive universal joint
- 1 1/4" drive spinner handle
- 1 1/4" drive swivel T-handle
- 1 1/4" reversible ratchet Ⓢ
- 16 1/2" square drive hexagon sockets ○ 10-11-12-13-14-15-16-17-18-19-21-22-24-27-30-32 mm
- 1 1/2" drive universal joint
- 1 1/2" wobble extension bar 125 mm
- 1 1/4" drive swivel T-handle
- 1 1/4" reversible ratchet Ⓢ
- 1 socket holder

Beta N.	TR
42	MC10
1084BM	MC10
96/SC9	MC10
1150BM	MC10
1166BM	MC10
1201E	MC10
1202E	MC10
860MX/A31	MC20
1048	MC20
1370	MC20
32	MC20
36	MC20
900	MC20
900/21	MC20
900/25	MC20
900BG/30C	MC20
900/42	MC20
900/55	MC20
920A	MC20
920/25	MC20
920AN/125	MC20
900/42	MC20
900/55	MC20
895/1	MC20

€

5927VU/M 927,00 059271021

Assortment recommended in combination with RSC22 - C27S - RSC23 - RSC23C

5938U/2T

assortment of 210 tools in ABS thermoformed trays

► Universal use

Quantity/Description

- 7 screwdriver for slotted head screws ● 2,5x50 - 3x75 - 3,5x100 - 4x125
5,5x100 - 5,5x150 - 6,5x150 mm
- 6 screwdriver for cross head Phillips® screws ● PH0x60-PH1x80-PH1x120-PH2x100-PH2x150-PH3x150 mm
- 7 screwdrivers
for Torx® head screws, with handles ◉ T6-T7-T8-T9-T10-T15-T20
- 1 circlip pliers straight, internal ◉ 180 mm
- 1 circlip pliers bent, internal ◉ 170 mm
- 1 circlip pliers straight, external ● 175 mm
- 1 circlip pliers bent, external ● 175 mm
- 1 Slip joint pliers boxed joints 240 mm
- 1 self - locking pliers 240 mm
- 1 Heavy-duty diagonal cutting nippers ◄ 160 mm
- 1 half-round needle nose pliers ≡ 180 mm
- 1 Extra-long needle nose pliers ● 160 mm
- 1 reversible ratcheting wrench for bits 1/4x5/16
- 13 1/4" hexagon sockets ◉ 4-4,5-5-5,5-6-7-8-9-10-11-12-13-14 mm
- 1 1/4" reversible ratchet Ⓢ 125 mm
- 1 1/4" drive swivel T-handle 115 mm
- 1 1/4" drive spinner handle 176 mm
- 1 1/4" drive universal joint 41 mm
- 1 1/4" drive extension bar 150 mm
- 1 magnetic bit holder with handle 230 mm
- 5 bits for Spanner screws ● 4-6-8-10-12 mm
- 8 bits for Torq-Set® head screws ◉ 0-1-2-3-4-5-6-8 mm
- 6 bits for Tri-Wing® head screws ● 1-2-3-4-5-6 mm
- 8 bits for Tamper Resistant Torx® head screws ◉ T9-T10-T15-T20-T25-T27-T30-T40
- 11 bits for Torx® head screws ◉ T6-T7-T8-T9-T10-T15-T20-T25-T27-T30-T40
- 3 bits for cross head Pozidriv®-Supadriv® screws ◉ PZ1 - PZ2 - PZ3
- 4 bits for cross head Phillips® screws ◉ PH0 - PH1 - PH2 - PH3
- 8 hexagon bits for power drivers ◉ 2 - 2,5 - 3 - 4 - 5 - 6 - 8 - 10 mm
- 7 bits for slotted head screws ● 0,5x3 - 0,6x4,5 - 0,8x5,5 - 1x5,5 - 1,2x6,5 - 1,2x8 - 1,6x8 mm
- 2 flat chisels, ribbed type 100 - 200 mm
- 1 engineer's hammer 300 g
- 1 soft face hammer Ø 35 mm
- 1 measuring tape 5 m
- 1 mini hacksaw frame
- 1 plastic oil bottle
- 1 snap - off blade utility knife
- 19 1/2" square drive hexagon sockets ◉ 10 - 11 - 12+19 - 20 - 21
22 - 23 - 24 - 26 - 27 - 30 - 32 mm
- 5 1/2" drive, socket drivers for hexagon screws ◉ 5 - 6 - 8 - 10 - 12 mm
- 1 1/2" drive extension bar 125 mm
- 1 1/2" drive extension bar 255 mm
- 1 1/2" drive universal joint
- 1 1/2" drive sliding T-handle
- 1 1/2" drive reversible ratchet Ⓢ
- 1 centre punch Ø 4 mm
- 6 pin punches with handles 2-3-4-5-6-8 mm
- 17 combination wrenches 6-7-8-10-11-12-13-14-16-17-18-19-21-22-24-27-30 mm
- 8 double open end wrenches 6x7 - 8x9 - 10x11 - 12x13 - 14x15 - 16x17 - 18x19 - 20x22 mm
- 9 offset hexagon key wrenches ◉
- 6 T-handle wrenches with hexagon male ends ◉ 2,5 - 3 - 4 - 5 - 6 - 8 mm
- 5 second cut files 200 mm
- 11 offset hexagon key wrenches ◉ 2 - 2,5 - 3 - 3,5 - 4 - 4,5 - 5 - 6 mm
- 4 thermoformed trays, empty
- 4 thermoformed trays, empty
- 4 thermoformed trays, empty

Beta N.	TR
1201E	T211
1202E	T213
1207E/TX	T216
1032	T145
1034	T145
1036	T145
1038	T145
1048	T153
1052	T153
1084BM	T137
1150BM	T137
1166BM	T137
194	T85
900	T85
900/55	T85
900/42	T85
900BG/30	T85
900/25	T85
900/21	T85
851SR	T85
861SP	T85
861TQS	T85
861TRW	T85
861TRX	T85
861TX	T85
861PZ	T85
861PH	T85
861PE	T85
861LP	T85
35	T234
1370	T234
1390	T234
1692	T289
1725CR	T289
1755	T289
1771	T289
920A	T80
920ME	T80
920/21	T80
920/22	T80
920/25	T80
920/42	T80
920/55	T80
32	T239
31BM	T239
42	T01
55	T33
96/SC9	T33
951	T68
1719BMA8/S5	T236
96T	T50
VP-3SC	VP-3SC
VP-LS	VP-LS
VP-LD	VP-LD

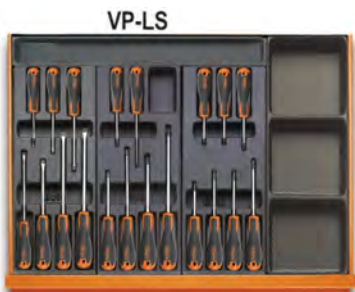

T211 T213 T216 VP3-SC
VP-LS



T145 T153 T137 VP3-SC
VP-LD



T85



T234 T289

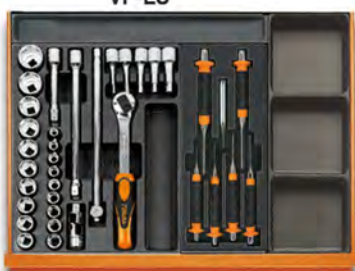

T80 T239 VP3-SC
VP-LS

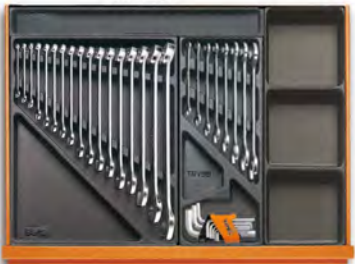

T01 T33 VP3-SC
VP-LD



T68 T236



T50

€

5938U/2T 2.250,00 059381062

Assortment recommended in combination with C38



5957U-P

assortment of 133 tools

► Universal use

Quantity/Description	Beta N.
6 pin punches 2 ÷ 8 mm	31/SP6
6 2 drift punches, 1 centre punch, 3 flat chisels with metal holder	38/SP6
17 combination wrenches 6÷22 - 24 - 27 - 30 - 32 mm	42/S17X
12 double open end wrenches 6x7 ÷ 30x32 mm	55/S12X
8 offset hexagon key wrenches 2 ÷ 10 mm	96T/S8
8 offset key wrenches, for Torx® head screws ⌚ T9 ÷ T40	97TX/SC8
1 adjustable wrench 250 mm	111
13 1/2" square drive hexagon sockets with rail ⌀ 10 ÷ 22 mm	920A/SB13
8 1/2" square drive hexagon sockets with rail ⌀ 23 ÷ 32 mm	920A/SB8
7 socket drivers for cross head Phillips® screws ⌚	920LH/SB7
⌚ 1,2x65 - 1,2x8 - 1,6x9 - 2x12mm - PH1-PH2-PH3	
1 circlip pliers straight, internal ⌀ 180 mm	1032
1 circlip pliers bent, internal ⌀ 170 mm	1034
1 circlip pliers straight, external ⌀ 175 mm	1036
1 circlip pliers bent, external ⌀ 175 mm	1038
1 Slip joint pliers boxed joints 250 mm	1048
1 self - locking pliers 240 mm	1052
1 tin snips 250 mm	1112
1 electrician's scissors, straight blades	1128BMX
8 set of screwdrivers 2,5x50 - 3x75 - 4x100 - 5,5x125 - 6,5x150 - PH0 - PH1 - PH2	1263/D8
2 engineer's hammer 300 - 600 g	1370
1 soft face hammer 35	1390
1 measuring tape 5 m	1692/5
1 flexible magnetic pick-up tool	1712E/2
1 two cutting edges scraper 200 mm	1717A
1 three - cutting edges scraper 200 mm	1717B
5 second cut files 200 mm	1719BMA8/S5
1 metal oil can 200 cc	1751
1 snap - off blade utility knife	1771BM
1 1/2" drive extension bar 125 mm	920/21
1 1/2" drive extension bar 250 mm	920/22
1 1/2" drive universal joint	920/25
1 1/2" drive sliding T-handle	920/42
1 1/2" drive reversible ratchet ⌚	920/55
1 pry bar	963
1 Diagonal cutting nippers ⌚ 160 mm	1082BM
1 Heavy-duty diagonal cutting nippers ⌚ 160 mm	1084BM
1 toggle lever assisted end cutting nippers ⌚ 180 mm	1092V
1 half-round needle nose pliers ⌚ 180 mm	1150BM
1 Extra-long needle nose pliers ⌚ 160 mm	1166BM
1 Extra-long bent needle nose pliers ⌚ 160 mm	1168BM
2 screwdrivers for slotted head screws ⌚ 8x200 - 10x200 mm	1260
1 screwdrivers for cross head Phillips® screws ⌚ PH3 8x150mm	1262
1 sliding gauge	1650
1 hacksaw frame, aluminium handle 420 mm	1725

€ 

5957U-P 2.325,00 059571004

Assortment recommended in combination with C57S A - C57S B - C57SP



5958U

Assortment of 85 tools

► Universal use

Quantity/Description	Beta N.
17 combination wrenches 6÷22 mm	42
12 offset hexagon key wrenches \odot 2÷10 mm	96N/SC12
13 1/2" square drive hexagon sockets with rail \odot 10÷22 mm	920A/SB13
8 1/2" square drive hexagon sockets with rail \odot 23÷32 mm	920A/SB8
1 1/2" drive extension bar 125 mm	920/21
1 1/2" drive extension bar 255 mm	920/22
1 1/2" drive universal joint	920/25
1 1/2" drive sliding T-handle	920/42
1 1/2" drive reversible ratchet \oplus	920/55
1 circlip pliers straight, internal \odot 180 mm	1032
1 circlip pliers straight, external \bullet 175 mm	1036
1 Slip joint pliers boxed joints 250 mm	1048
1 self - locking pliers 240 mm	1052
1 Heavy-duty diagonal cutting nippers ∇ 160 mm	1084BM
1 electrician's scissors, straight blades	1128BMX
1 half-round needle nose pliers \equiv 180 mm	1150BM
1 Extra-long needle nose pliers \bullet 160 mm	1166BM
7 screwdrivers for slotted head screws \bullet 3x75 - 3,5x100 - 4x125 5,5x150 - 6,5x150 - 8x200 - 10x200 mm	1260
4 screwdrivers for cross head Phillips® screws \oplus PH0x60 - PH1x80 PH2x100 - PH3x150 mm	1262/S4
1 engineer's hammer 300 g	1370
1 soft face hammer \varnothing 35 mm	1390
1 measuring tape 5 m	1692
5 Set of 5 second-cut files, with handles 200 mm	1719BMA...S5
1 hacksaw frame, aluminium handle	1725
1 plastic oil can 150 cc	1754
1 snap - off blade utility knife	1771

€ 

5958U 1.177,00 059581008

Assortment recommended in combination with C58P - C45 - C55



5990V1

assortment of 44 tools for tool case COMBO C99V1, in EVA foam tray

► Universal use

Quantity/Description

- 9 ball head offset hexagon key wrenches ○
- 1 snap - off blade utility knife 18 mm
- 1 Slip joint pliers boxed joints 250 mm
- 6 set of 2 drift punches, 1 centre punch, 2 flat chisels and 1 cape chisel in roll-up wallet made of polyester
- 3 screwdrivers for slotted head screws ● 3,5x100-5,5x125-6,5x150 mm
- 3 screwdrivers for cross head Phillips® screws ⊕ PH0x60-PH1x80-PH2x100 mm
- 1 electrician's scissors, straight blades
- 16 combination wrenches 6-7-8-9-10-11-12-13-14-15-16-17-18-19-21-22 mm
- 1 measuring tape 5 mt
- 1 engineer's hammer 300 g
- 1 diagonal cutting nippers, bi-material handles, industrial finish ≤ 160 mm
- 1 heavy duty combination pliers, bi-material handles, industrial finish = 180 mm

Beta N.
96BPC/SC9
1771
1048
38/B6N
1260
1262
1128BMX
42
1692/5
1370
1082GBM
1150GBM

€

5990V1 556,00 059900001

Assortment recommended in combination with C99V1

5990V3

assortment of 116 tools for tool case COMBO C99V3/2C, in EVA foam tray

► Car repairs

Quantity/Description

- 5 offset hexagon key wrenches
- 1 adjustable wrench 250 mm
- 1 1/4" drive spinner handle
- 1 mains testing screwdriver ●
- 1 pocket spirit level with magnetic V-shaped base
- 1 LED inspection torch,
- made of sturdy anodized aluminium
- 31 bits with magnetic quick release bit holder in plastic case ● ○ ⊕ ⊕ ⊕ ⊕
- 1 socket holder
- 12 1/4" hexagon sockets ○ 4-4,5-5-5,5-6-7-8-9-10-11-12-13 mm
- 1 1/4" drive extension bar 50 mm
- 1 1/4" drive extension bar 100 mm
- 1 1/4" drive swivel T-handle
- 1 1/4" drive reversible ratchet, 72 tooth mechanism ⊕
- 38 microscrewdriver with 36 interchangeable 4-mm bits and magnetic extension
- 1 soft face hammer Ø 35mm
- 1 1/4" drive universal joint
- 13 1/2" square drive hexagon sockets ○ 10-11-12-13-14-15-16-17-18-19-20-21-22 mm
- 1 1/2" drive extension bar 125 mm
- 1 1/2" drive extension bar 255 mm
- 1 1/2" drive universal joint
- 1 1/2" drive sliding T-handle
- 1 1/2" drive reversible ratchet ⊕

Beta N.
96T/S5P
111
900BG/30
1253
1695XS
1833XS/2
860MIX/A31
895
900
900/20
900/20L
900/42
900/55Z
1256/C36-2
1390
900/25
920A
920/21
920/22
920/25
920/42
920/55

€

5990V3 793,00 059900003

Assortment recommended in combination with C99V3/2C

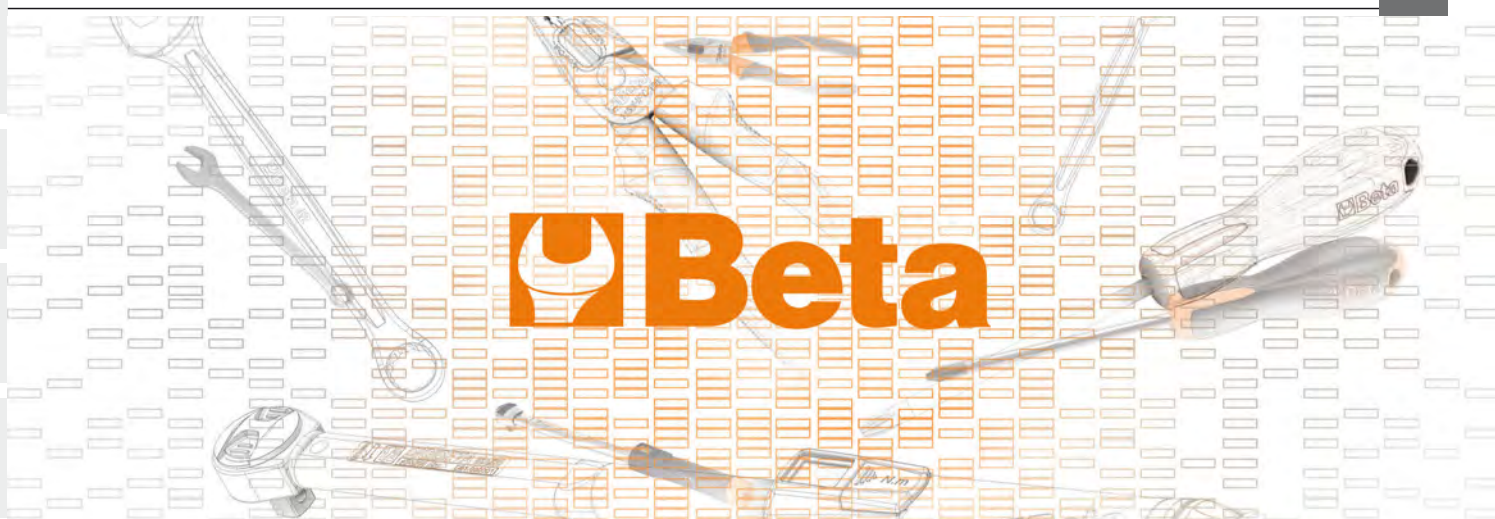

5980U/BIKE

assortment of 90 tools

► Bicycle repairs

Quantity/Description	Beta N.
5 combination wrenches 8-9-10-13-14 mm	42
9 ball head offset hexagon key wrenches burnished \odot 1,5-2-2,5-3-4-5-6-8-10 mm	96BP/SC9
8 offset hexagon key wrenches 2-2,5-3-4-5-6-8-10 mm	96T/S8
8 drivers for Torx® head screws, with handles \odot T8-T10-T15-T20-T25-T27-T30-T40	97TTX/S8
1 adjustable wrenches with scales chrome-plated 200 mm	111G
1 pipe cutter for copper and light alloy pipes	334
1 click-type torque wrenches with reversible ratchets 2÷10 Nm	605E
13 \odot 4-4,5-5-5,5-6-7-8-9-10-11-12-13-14 mm	900/SB13
1 1/4" drive extension bar	900/21
1 1/4" drive universal joint	900/25
1 1/4" reversible ratchet \odot	900/55
1 diagonal cutting nippers, slip-proof double layer PVC coated handles, industrial finish \triangleleft 160 mm	1082G
1 electrician's scissors, straight blades 145 mm	1128BM
1 heavy duty combination pliers, slip-proof double layer PVC coated handles, industrial finish \equiv 180 mm	1150G
1 extra-long needle knurled nose pliers, slip-proof double layer PVC coated handles, industrial finish \bullet 180 mm	1166G
7 3x75-4x125-5,5x150-6,5x150-PH0x60-PH1x80-PH2x100 mm	1203E/D
1 engineer's hammer 300 g	1370
1 soft face hammer \varnothing 35 mm	1390
1 sliding gauge 150 mm	1650
1 measuring tape 3 m	1692/3
1 second-cut flat files 200 mm	1719BMA...P
1 second-cut half-round files 200 mm	1719BMA...M
1 second-cut round files 200 mm	1719BMA...R
1 hacksaw frame, aluminium handle 300 mm	1725
1 snap - off blade utility knife	1771
1 chain wear indicator 120 mm	3935
1 missing link pliers 170 mm	3937
7 set of 7 simple cone wrenches 13-14-15-16-17-18-19 mm	3952/S7
1 pedal wrench 15 mm	3953
1 spoke wrench, black, 3,2 mm \square	3961 3,2
1 spoke wrench, green, 3,3 mm \square	3961 3,3
1 spoke wrench, red, 3,5 mm \square 3	3961 3,5
1 professional spoke wrench, 3,2 - 4,0 mm \square 3,2 - 4,0 mm	3961U
1 sprocket removal wrench with chain whip 289 mm	3967
1 tyre lever 200 mm	3969
3 kit with 3 tyre levers, made of plastic 113 mm	3969K3
1 lever for pushing back disc brake pads 222 mm	3991
1 disc brake straightener 234 mm	3992



€ 

5980U/BIKE 1.405,00 059801040

Assortment recommended in combination with C16 - CP17 - CP17L - C20L

5988H/7M

assortment of 333 tools in EVA foam trays

► Car repairs

Quantity/Description

- 13 hexagon hand sockets ○ 8-9-10-11-12-13-14-15-16-17-19-21-22 mm
- 16 hexagon hand sockets ○ 10-12-13-14-15-16-17-18-19-21-22-23-24-27-30-32 mm
- 7 1/2" sockets for Torx® head screws ○ E12-E14-E16-E18-E20-E22-E24
- 10 socket drivers for hexagon screws ○ 5-6-6L-7-8-8L-10-10L-12-12L mm
- 13 1/2" drive, socket drivers for Torx® head screws ○ T20-T25-T27-T30-T30L-T40-T40L-T45-T50-T50L-T55-T60-T60L
- 8 socket drivers with XZN® profile ○ 5-6-6L-8-8L-10-10L-12L mm
- 18 combination wrenches 6-7-8-9-10-11-12-13-14-15-16-17-18-19-21-22-24-27 mm
- 7 double ended offset ring wrenches 6x7-8x9-10x11-12x13-14x15-16x17-18x19 mm
- 1 quick release adaptor, 1/4", for 10 mm ratcheting wrenches
- 1 quick release adaptor, 3/8", for 13 mm ratcheting wrenches
- 1 quick release adaptor, 1/2", for 19 mm ratcheting wrenches
- 12 reversible ratcheting combination wrenches 8-9-10-11-12-13-14-15-16-17-18-19 mm
- 9 ball head offset hexagon key wrenches ○ 1,5-2-2,5-3-4-5-6-8-10 mm
- 1 socket holder ○ 1/4-□1/4
- 1 socket holder ○ 1/4-□3/8
- 1 socket holder ○ 5/16-□1/2
- 13 1/4" hexagon sockets ○ 4-4,5-5-5,5-6-7-8-9-10-11-12-13-14 mm
- 9 hexagon hand sockets, long series ○ 5-6-7-8-9-10-11-12-13 mm
- 4 socket drivers for slotted head screws ● 0,8x4-1x5,5-1,2x6,51,2x8 mm
- 5 1/4" socket drivers for hexagon screws ○ 3-4-5-6-7 mm
- 4 socket drivers for cross head Phillips® screws ● PH1-PH2-PH3-PH4
- 7 socket drivers for Torx® head screws ○ T10-T15-T20-T25-T27-T30-T40
- 1 adaptor, 1/4" female and 3/8" male drives □1/4-■3/8
- 3 1/4" drive extension bar 50-100-150 mm
- 1 1/4" drive universal joint
- 1 1/4" drive swivel T-handle
- 1 1/4" reversible ratchet ⊕
- 1 1/4" drive spinner handle
- 17 hexagon hand sockets 3/8" ○ 6-7-8-9-10-11-12-13-14-15-16-17-18-19-20-21-22 mm
- 1 adaptor, 3/8" female and 1/4" male drivers □3/8-■1/4
- 1 adaptor, 1/2" female and 3/8" male drives □3/8-■1/2
- 1 extension bar - 3/8" 125 mm
- 1 extension bar - 3/8" 250 mm
- 1 3/8" drive universal joint
- 1 3/8" drive sliding T - handle
- 1 3/8" drive reversible ratchet ⊕
- 21 1/2" square drive hexagon sockets ○ 8-10-11-12-13-4-15-16-17-18-19-20-21-22-23-24-26-27-28-30-32 mm
- 2 1/2" wobble extension bar 125-250 mm
- 1 adaptor, 1/2" female and 3/8" male drives □1/2-■3/8
- 1 1/2" drive universal joint
- 1 1/2" drive sliding T-handle
- 1 1/2" drive reversible ratchet ⊕
- 3 3/8" square drive spark plug sockets ○ 16-17,8-20,8 mm
- 31 bits with magnetic quick release bit holder in plastic case ○ ● ⊕ ⊕ ⊕ ⊕
- 1 Slip joint pliers boxed joints 250 mm
- 1 Diagonal cutting nippers † 160 mm
- 1 half-round needle nose pliers ≡ 180 mm
- 1 Extra-long flat knurled nose pliers ≡ 160 mm
- 5 screwdrivers for cross head Phillips® screws ● 3x75-4x100-5,5x100-6,5x150-8x150 mm
- 1 screwdriver for slotted head screws, extra-short series ● 6,5x30 mm
- 3 screwdrivers for cross head Phillips® screws ● PH1-PH2-PH3
- 1 screwdriver for cross head Phillips® screws, extra-short series ● PH2
- 4 drivers for Torx® head screws, with handles ○ T20-T25-T27-T30
- 6 pin punches 2-3-4-5-6-8 mm
- 1 centre punch 4 mm
- 3 flat chisels 125-150-75 mm
- 1 cape chisels, standard type 125 mm
- 2 engineer's hammer 500-1000 g
- 1 telescopic magnet with flexible head
- 1 soft face hammer Ø 35 mm
- 1 measuring tape 5 m
- 1 circlip pliers straight, internal ○ 180 mm
- 1 circlip pliers bent, internal ○ 170 mm
- 1 circlip pliers straight, external ● 175 mm
- 1 circlip pliers bent, external ● 175 mm
- 1 smooth half - round long needle nose pliers ● 140 mm
- 1 diagonal cutting nippers † 125 mm
- 4 micro-screwdrivers for slotted head screws ● 2,0-2,5-3,0-3,5 mm
- 2 micro-screwdrivers for cross-head Phillips® screws ● 0-00
- 9 drivers for Torx® head screws, with handles ○ T10-T15-T20-T25-T27-T30-T40-T45-T50
- 1 self - locking pliers 240 mm
- 1 adjustable self locking pliers, long jaws 175 mm
- 1 plastic hose pliers
- 1 plastic hose pliers
- 1 sliding gauge
- 1 metric feeler gauge
- 1 packing scraper
- 7 double swivel end socket wrenches 6x7-8x9-10x11-12x13-14x15-16x17-18x19 mm
- 1 1/2" drive swivel handle
- 1 pry bar with handle 450 mm
- 1 telescopic joint inspection mirror 670 mm
- 1 second cut files 200 mm
- 1 second cut files 200 mm
- 1 second cut files 200 mm
- 1 second cut files 200 mm
- 1 second cut files 200 mm
- 1 Steel wire brush

Beta N.	TR
910AL	M125
920AL	M125
920FTX	M125
920PE	M125
920TX	M125
920XZN	M125
	42
	M25
	90
	M25
	123Q1/4
	M25
	123Q3/8
	M25
	123Q1/2
	M25
	142
96BPC/SC9	M105
	895/1
	M105
	895/3
	M105
	895/6
	M105
	900
	M105
	900L
	M105
	900LP
	M105
	900ME
	M105
	900PH
	M105
	900TX
	M105
	900/16
	M105
	900/...
	M105
	900/25
	M105
	900/42
	M105
	900/55
	M105
900BG/30	M105
	910A
	M105
	910/15
	M105
	910/16
	M105
	910/21
	M105
	910/22
	M105
	910/25
	M105
	910/42
	M105
	910/55
	M105
	920A
	M105
	920AN
	M105
	920/15
	M105
	920/25
	M105
	920/42
	M105
	920/55
	M105
	956E
	M105
860MIX/A31	M166
	1048
	M166
	1082BM
	M166
	1150BM
	M166
	1162BM
	M166
	1290
	M166
	1290N
	M166
	1292
	M166
	1292N
	M166
	1297TX
	M166
	31
	M231
	32
	M231
	34
	M231
	36
	M231
	1370
	M231
	1712TF
	M231
	1390
	M231
	1692
	M125
	1032
	M62
	1034
	M62
	1036
	M62
	1038
	M62
	1177BM
	M62
	1188BM
	M62
	1257LP
	M62
	1257PH
	M62
	97TTX
	M62
	1052
	M78
	1058
	M78
	1481PL/A
	M78
	1481PL/B
	M78
	1481PL/C
	M78
	1650
	M78
	1708/20
	M78
	1716P
	M78
	80
	M78
	920/36A
	M78
	965
	M78
	1715
	M231
	1719BMA/8M
	M231
	1719BMA/8P
	M231
	1719BMA/8Q
	M231
	1719BMA/8R
	M231
	1719BMA/8T
	M231
	1737NX
	M231



M125



M25



M105



M166



M231



M62



M78

€

5988H/7M 4.870,00 059881087

Assortment recommended in combination with RSC24/8 - RSC24A/8 - RSC24AXL - C37/8 - C39/8 - RSC28 - C59B

5988L/4M

assortment of 273 tools in EVA foam trays

► Car repairs

Quantity/Description



M105



M125



M25



M166

- 13 1/4" hexagon sockets ○ 4-4,5-5-5,5-6-7-8-9-10-11-12-13-14 mm
- 9 hexagon hand sockets, long series ○ 5-6-7-8-9-10-11-12-13 mm
- 9 ball head offset hexagon key wrenches ○ 1,5-2-2,5-3-4-5-6-8-10 mm
- 1 socket holder
- 1 socket holder
- 1 socket holder
- 5 1/4" socket drivers for hexagon screws ○ 3-4-5-6-7 mm
- 4 socket drivers for slotted head screws ● 0,8x4-1x5,5-1,2x6,5-2x8 mm
- 4 socket drivers for cross head Phillips® screws ● PH1-PH2-PH3-PH4
- 7 socket drivers for Torx® head screws ⊕ T10-T15-T20-T25-T27-T30-T40
- 1 adaptor, 1/4" female and 3/8" male drives □ 1/4 - ■ 3/8
- 3 1/4" drive extension bar 50-100-150 mm
- 1 1/4" drive universal joint
- 1 1/4" drive spinner handle
- 1 1/4" drive swivel T-handle
- 1 1/4" reversible ratchet ⊗
- 17 hexagon hand sockets 3/8" ○ 6-7-8-9-10-11-12-13-14-15-16-17-18-19-20-21-22 mm
- 1 adaptor, 3/8" female and 1/4" male drives □ 3/8 - ■ 1/4
- 1 adaptor, 1/2" female and 3/8" male drives □ 3/8 - ■ 1/2
- 1 extension bar - 3/8" 125 mm
- 1 extension bar - 3/8" 250 mm
- 1 3/8" drive universal joint
- 1 3/8" drive sliding T - handle
- 1 3/8" drive reversible ratchet ⊗
- 17 1/2" square drive hexagon sockets ○ 8-10-11-12-13-14-15-16-17-18-19-20-21-22-23-24-26-27-28-30-32 mm
- 1 adaptor, 1/2" female and 3/8" male drives □ 1/2 - ■ 3/8
- 1 3/8" drive universal joint
- 2 1/2" wobble extension bar 125 - 250 mm
- 1 1/2" drive sliding T-handle
- 1 1/2" drive reversible ratchet ⊗
- 3 3/8" square drive spark plug sockets ○ 16-17,8-20,8 mm
- 13 hexagon hand sockets ○ 8-9-10-11-12-13-14-15-16-17-19-21-22 mm
- 10 socket drivers for hexagon screws ○ 5-6-6L-7-8-8L-10-10L-12-12L mm
- 7 1/2" sockets for Torx® head screws ⊕ E12-E14-E16-E18-E20-E22-E24
- 13 1/2" drive, socket drivers for Torx® head screws ⊕ T20-T25-T27-T30-T30L-T40-T40L-T45-T50-T50L-T55-T60-T60L
- 8 socket drivers with XZN® profile ○ 5-6-6L-8-8L-10-10L-12L mm
- 16 hexagon hand sockets ○ 10-12-13-14-15-16-17-18-19-21-22-23-24-27-30-32 mm
- 1 measuring tape 5 m
- 18 combination wrenches 6-7-8-9-10-11-12-13-14-15-16-17-18-19-21-22-24-27 mm
- 7 double ended offset ring wrenches 6x7-8x9-10x11-12x13-14x15-16x17-18x19 mm
- 1 quick release adaptor, 1/4", for 10 mm ratcheting wrenches
- 1 quick release adaptor, 3/8", for 13 mm ratcheting wrenches
- 1 quick release adaptor, 1/2", for 19 mm ratcheting wrenches
- 12 reversible ratcheting combination wrenches 8-9-10-11-12-13-14-15-16-17-18-19 mm
- 31 bits with magnetic quick release bit holder in plastic case ○ ● ⊕ ⊕ ⊕ ⊕
- 1 Slip joint pliers boxed joints 250 mm
- 1 Diagonal cutting nippers ✂ 160 mm
- 1 half-round needle nose pliers = 180 mm
- 1 Extra-long flat knurled nose pliers = 160 mm
- 5 screwdrivers for cross head Phillips® screws ● 3x75-4x100-5,5x100-6,5x150-8x150 mm
- 1 screwdriver for slotted head screws, extra-short series ● 6,5x30 mm
- 3 screwdrivers for cross head Phillips® screws ● 4,5x80-6x100-8x150 mm
- 1 screwdriver for cross head Phillips® screws, extra-short series ● 6x30 mm
- 4 drivers for Torx® head screws, with handles ⊕ T20-T25-T27-T30

Beta N.	TR
900	M105
900L	M105
96BPC/SC9	M105
895/1	M105
895/3	M105
895/6	M105
900ME	M105
900LP	M105
900PH	M105
900TX	M105
900/16	M105
900/...	M105
900/25	M105
900BG/30	M105
900/42	M105
900/55	M105
910A	M105
910/15	M105
910/16	M105
910/21	M105
910/22	M105
910/25	M105
910/42	M105
910/55	M105
920A	M105
920/15	M105
910/25	M105
920AN	M105
920/42	M105
920/55	M105
956E	M105
910AL	M125
920PE	M125
920FTX	M125
920TX	M125
920XZN	M125
920AL	M125
1692/5	M125
42	M25
90	M25
123Q1/4	M25
123Q3/8	M25
123Q1/2	M25
142	M25
860MIX/A31	M166
1048	M166
1082BM	M166
1150BM	M166
1162BM	M166
1290	M166
1290N	M166
1292	M166
1292N	M166
1297TX	M166

€

5988L/4M

3.470,00 059881088

Assortment recommended in combination with items RSC24 - RSC24A - RSC24AXL - RSC24L - RSC24L-CAB - C37 - C39 - C39T - C39SM - C39MD - RSC55 - C59

5988U6/M

assortment of 214 tools in EVA foam trays

► Universal use

Quantity/Description

- 22 combination wrenches 6-7-8-9-10-11-12-13-14-15-16-17-18-19-20-21-22-24-27-30-32-36 mm
- 11 double open end wrenches 6x7-8x9-10x11-12x13-14x15-16x17
18x19-20x22-21x23-24x27-30x32 mm
- 11 double ended offset ring wrenches 6x7-8x9-10x11-12x13-14x15-16x17-18x19-20x22-21x23-24x27-30x32 mm
- 9 ball head offset hexagon key wrenches \odot 1,5-2-2,5-3-4-5-6-8-10 mm
- 6 screwdriver for slotted head screws \bullet 2,5x50-3x75-4x100-5,5x125-6,5x150-8x200 mm
- 1 screwdriver for slotted head screws, extra-short series \bullet 4x30 mm
- 4 screwdriver for cross head Phillips® screws \oplus PH0x60-PH1x80-PH2x100-PH3x150 mm
- 1 screwdriver for cross head Phillips® screws, extra-short series \oplus PH1x30 mm
- 12 screwdrivers for Torx® head screws, with handles \odot T6-T7-T8-T9-T10-T15-T20-T25-T27-T30-T40-T45
- 1 mains testing screwdriver \bullet
- 3 drift punches \varnothing 2-3-4 mm
- 6 pin punches \varnothing 2-3-4-5-6-8 mm
- 1 centre punch \varnothing 4 mm
- 1 flat chisels 150 mm
- 2 flat chisels, ribbed type 200-250 mm
- 1 cape chisels, standard type 125 mm
- 1 engineer's hammer 500 g
- 1 soft face hammer \varnothing 35 mm
- 1 measuring tape 3 m
- 1 telescopic magnet with flexible head
- 1 second-cut square files 200 mm
- 1 second-cut triangular files 200 mm
- 1 second-cut flat files 200 mm
- 1 second-cut half-round files 200 mm
- 1 second-cut round files 200 mm
- 1 Steel wire brush
- 1 snap - off blade utility knife 18 mm
- 1 circlip pliers straight, internal \odot 180 mm
- 1 circlip pliers bent, internal \odot 170 mm
- 1 circlip pliers straight, external \bullet 175 mm
- 1 circlip pliers bent, external \bullet 175 mm
- 1 Slip joint pliers boxed joints 250 mm
- 1 self - locking pliers 240 mm
- 1 Diagonal cutting nippers \ddagger 160 mm
- 1 construction worker's pincers 220 mm
- 1 tin snips 250 mm
- 1 electrician's scissors, straight blades
- 1 half-round needle nose pliers \equiv 180 mm
- 1 Extra-long needle nose pliers \bullet 160 mm
- 1 Extra-long bent needle nose pliers \bullet 160 mm
- 1 socket holder
- 1 socket holder
- 1 socket holder
- 13 1/4" hexagon sockets \odot 4-4,5-5-5,5-6-7-8-9-10-11-12-13-14 mm
- 9 hexagon hand sockets, long series \odot 5-6-7-8-9-10-11-12-13 mm
- 5 1/4" socket drivers for hexagon screws \odot 3-4-5-6-7 mm
- 4 socket drivers for slotted head screws \bullet 0,8x4-1x5,5-1,2x6,5-1,2x8 mm
- 4 socket drivers for cross head Phillips® screws \oplus PH1-PH2-PH3-PH4
- 7 socket drivers for Torx® head screws \odot T10-T15-T20-T25-T27-T30-T40
- 1 1/4" drive extension bar 50 mm
- 1 1/4" drive extension bar 100 mm
- 1 1/4" drive extension bar 150 mm
- 1 1/4" drive universal joint
- 1 1/4" drive spinner handle
- 1 1/4" drive swivel T-handle
- 1 1/4" reversible ratchet \oplus
- 21 1/2" square drive hexagon sockets \odot 8-10-11-12-13-14-15-16-17-18-19-20-21-22-23-24-26-27-28-30-32 mm
- 1 adaptor, 1/2" female and 3/8" male drives 125 mm
- 1 1/2" drive universal joint 250 mm
- 1 1/2" wobble extension bar
- 1 1/2" wobble extension bar
- 1 1/2" drive sliding T-handle
- 1 1/2" drive reversible ratchet \oplus
- 8 1/2" sockets for Torx® head screws \odot 10-12-14-16-18-20-22-24 mm
- 11 hexagon hand sockets \odot 10-12-13-14-15-16-17-18-19-21-22 mm

Beta N.	TR
42	M01
55	M30
90	M30
96BPC/SC9	M30
1201E	M213
1201EN	M213
1202E	M213
1202EN	M213
1207E/TX	M213
1253	M213
30	M230
31	M230
32	M230
34	M230
35	M230
36	M230
1370	M230
1390	M230
1692	M230
1712TF	M230
1719BMA...Q	M230
1719BMA...T	M230
1719BMA...P	M230
1719BMA...M	M230
1719BMA...R	M230
1737NX	M230
1771	M230
1032	M129
1034	M129
1036	M129
1038	M129
1048	M129
1052	M129
1082BM	M129
1098	M129
1112	M129
1128BM	M129
1150BM	M129
1166BM	M129
1168BM	M129
895/1	M100
895/3	M100
895/6	M100
900	M100
900L	M100
900ME	M100
900LP	M100
900PH	M100
900TX	M100
900/20	M100
900/20L	M100
900/21	M100
900/25	M100
900BG/30	M100
900/42	M100
900/55	M100
920A	M100
920/15	M100
920/25	M100
920AN/125	M100
920AN/250	M100
920/42	M100
920/55	M100
920FTX	M100
920AL	M100



M01



M30



M213



M230



M129

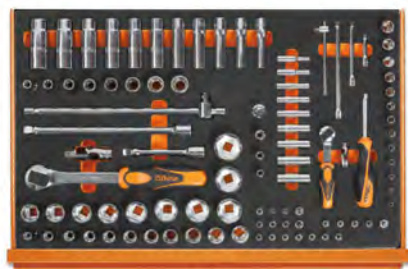

M100

€

5988U6/M

2.890,00 059881430

Assortment recommended in combination with RSC24 with 8 drawers - RSC24/A with 8 drawers - C37 with 8 drawers - C39 with 8 drawers RSC24AXL - RSC28 - C39SM - C39MO - C59B - C55

5935ET/1MB

assortment of 96 tools for tool chest C35, in EVA foam trays

► Electrotechnical maintenance

Quantity/Description

- 1 self-locking pliers 240 mm
- 1 engineer's hammer 500 g
- 1 soft face hammer Ø 35 mm
- 1 second-cut square files 200 mm
- 1 second-cut flat files 200 mm
- 1 second-cut triangular files 200 mm
- 1 second-cut half-round files 200 mm
- 1 second-cut round files 200 mm
- 1 flat chisels, ribbed type 200 mm
- 1 circlip pliers straight, internal ⌀ 180 mm
- 1 circlip pliers bent, internal ⌀ 170 mm
- 1 circlip pliers straight, external ● 175 mm
- 1 circlip pliers bent, external ● 175 mm
- 1 Heavy-duty diagonal cutting nippers ≤ 160 mm
- 1 half-round needle nose pliers = 180 mm
- 1 Extra-long needle nose pliers ● 160 mm
- 9 ball head offset hexagon key wrenches ○
- 1 screwholding screwdriver for slotted head screws ●
- 1 screwholding screwdriver for cross head Phillips® screws ⊕
- 1 mains testing screwdriver ●
- 6 hexagon nut spinners with handles ○ 5,5-6-7-8-10-13 mm
- 4 screwdrivers for cross head Phillips® screws, 1000V
- ⊕ PH0x60-PH1x80-PH2x100-PH3x150 mm
- 6 screwdrivers for headless slotted screws, 1000V
- 2,5x75-3x100-4x100-5,5x125-6x150-8x175 mm
- 31 bits with magnetic quick release bit holder in plastic case ● ○ ⊕ ⊕ ⊕ ⊕
- 1 magnetic bit holder, insulated ⊕
- 8 double open end wrenches 6x7-8x9-10x11-12x13-14x15
16x17-18x19-20x22 mm
- 1 slip joint pliers, boxed joint 250 mm
- 1 diagonal cutting nippers 1000V ≤ 140 mm
- 1 electrician's scissors, straight blades, with countersink
- 1 cable cutter 230 mm
- 1 wire stripping pliers † 160 mm
- 1 combination pliers 1000V = 180 mm
- 1 extra long needle nose pliers, 1000V, ● 160 mm
- 1 extra long bent needle nose pliers ● 160 mm
- 1 adjustable wrench, 1000V 250 mm
- 1 utility knife, 1000V
- 1 bent knurled point spring tweezers, 1000V
- 1 crimping pliers for insulated terminals

Beta N.	TR
1052	MB65
1370	MB65
1390	MB65
1719BMA...Q	MB65
1719BMA...P	MB65
1719BMA...T	MB65
1719BMA...M	MB65
1719BMA...R	MB65
35	MB65
1032	MB65
1034	MB65
1036	MB65
1038	MB65
1084BM	MB65
1150BM	MB65
1166BM	MB65
96BPC/SC9	MB63
1250	MB63
1251	MB63
1253	MB63
943MQ	MB63
1272MQ	MB63
1274MQ	MB63
860MIX/A31	MB63
850MQ	MB63
55	MB64
1048MQ	MB64
1082MQ	MB64
1128BSX	MB64
1132MQ	MB64
1142MQ	MB64
1150MQ	MB64
1166MQ	MB64
1168MQ	MB64
110MQ	MB64
1777MQ	MB64
993MQ	MB64
1602	MB64



MB65



MB64

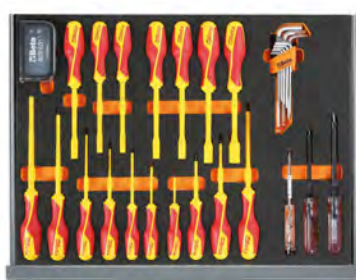

MB63

€

5935ET/1MB 1.655,00 059351332

Assortment recommended in combination with C35



5980ET/A

assortment of 70 tools

► Electrotechnical maintenance

Quantity/Description	Beta N.
1 centre punch Ø 4 mm	32
1 flat chisels, ribbed type 150 mm	35
8 6x7 - 8x9 - 10x11 - 12x13 - 14x15 - 16x17 - 18x19 - 20x22 mm	55/B8N
8 offset hexagon key wrenches, long series \odot 2+10 mm	96LC/SC8
1 adjustable wrench 200 mm	111
1 magnetic bit holder, insulated $\text{\textcircled{B}}$	850MQ
10 bits with magnetic bit holder in plastic case $\text{\textcircled{+}}$ $\text{\textcircled{+}}$	860MIX/A10
1 slip joint pliers, boxed joint 250 mm	1048MQ
1 Diagonal cutting nippers $\text{\textcircled{+}}$ 160 mm	1082BM
1 electrician's scissors, straight blades, with countersink	1128BSX
1 cable cutter 170 mm	1132BM
1 half-round needle nose pliers $\text{\textcircled{=}}$ 180 mm	1150BM
1 Extra-long needle nose pliers $\text{\textcircled{+}}$ 160 mm	1166BM
1 Extra-long bent needle nose pliers $\text{\textcircled{+}}$ 160 mm	1168BM
1 screwholding screwdriver for slotted head screws $\text{\textcircled{+}}$ 4x125 mm	1250
1 screwholding screwdriver for cross head Phillips® screws $\text{\textcircled{+}}$ PH1x150 mm	1251
1 mains testing screwdriver $\text{\textcircled{+}}$	1253
5 screwdriver for slotted head screws $\text{\textcircled{+}}$ 2,5x75 - 3,5x100 - 5,5x125 - 6,5x150 mm	1201E
1 screwdriver for slotted head screws, extra-short series $\text{\textcircled{+}}$ 4x30 mm	1201EN
4 screwdriver for cross head Phillips® screws $\text{\textcircled{+}}$ PH0x60 - PH1x120 - PH2x150 - PH3x150 mm	1202E
1 screwdriver for cross head Phillips® screws, extra-short series $\text{\textcircled{+}}$ PH2x30 mm	1202EN
4 screwdrivers for cross head Phillips® screws, 1000V $\text{\textcircled{+}}$ PH0x60 - PH1x80 - PH2x100 - PH3x150 mm	1272MQ
5 screwdrivers for headless slotted screws, 1000V $\text{\textcircled{+}}$ 5,5x125 - 3x100 - 4x100 - 6,5x150 - 8x175 mm	1274MQ
1 flat chisel with side cutter	1343
1 engineer's hammer 300 g	1370
1 soft face hammer Ø 35 mm	1390
1 crimping pliers for insulated terminals	1602
1 PVC electrical tape 25 m	BMESB1928NE
1 measuring tape 5 m	1692
1 second-cut half-round files 200 mm	1719BMA...M
1 second-cut round files 200 mm	1719BMA...R
1 hacksaw frame, aluminium handle	1725
1 fold - away knife	1777BM

€



5980ET/A 868,00 059801083

Assortment recommended in combination with C12 - 2028VV - 2032TV - 2032VV

5980ET/B

assortment of 64 tools

► Electrotechnical maintenance

Quantity/Description

- 3 pin punches Ø 2 - 3 - 4 mm
- 1 centre punch Ø 4 mm
- 1 flat chisels 150 mm
- 8 6x7 - 8x9 - 10x11 - 12x13 - 14x15 - 16x17 - 18x19 - 20x22 mm
- 9 ball head offset hexagon key wrenches \odot 1,5 - 2 - 2,5 - 3 - 4 - 5 - 6 - 8 - 10 mm
- 1 deburrer 150 mm
- 6 hexagon nut spinners with handles 1000V \odot 5,5 - 6 - 7 - 8 - 10 - 13 mm
- 1 slip joint pliers, boxed joint 250 mm
- 1 diagonal cutting nippers 1000V \nlessdot 160 mm
- 1 electrician's scissors, straight blades, with countersink
- 1 cable cutter 230 mm
- 1 wire stripping pliers \nlessdot 160 mm
- 1 combination pliers 1000V \nlessdot 180 mm
- 1 extra long needle nose pliers, 1000V, \bullet 160 mm
- 1 mains testing screwdriver \bullet
- 3 screwdrivers for cross head Phillips® screws, 1000V \oplus PH0x60 - PH1x80 - PH2x100 mm
- 4 screwdrivers for headless slotted screws, 1000V \bullet 3x100 - 4x100 - 5,5x125 - 6,5x150 mm
- 1 engineer's hammer 300 g
- 1 soft face hammer Ø 35 mm
- 1 crimping pliers for insulated terminals
- 1 flexible graduated rule 250 mm
- 1 engineer's scriber 250 mm
- 1 measuring tape 5 m
- 1 spirit level, made of aluminium 200 mm
- 1 electrician's chisel 10x200 mm
- 1 chalk line reel
- 1 square flexible inspection mirror 600 mm
- 1 second cut files 200 mm
- 1 second cut files 200 mm
- 1 spring puller
- 1 hacksaw frame, aluminium handle
- 1 bristle brush
- 1 fitting tool for nylon ties
- 1 plastic oil bottle 80 cc
- 100 nylon cable ties, black UV resistant 3,6x200 mm
- 100 nylon cable ties, black UV resistant 4,8x300 mm
- 1 snap - off blade utility knife
- 1 soldering iron 30 W
- 1 LED inspection torch, made of sturdy anodized aluminium

Beta N.
31
32
34
55/B8N
96BPC/SC9
345SB
943MQ/S6
1048MQ
1082MQ
1128BSX
1132MQ
1142MQ
1150MQ
1166MQ
1253
1272MQ
1274MQ
1370
1390
1602
1682
1688
1692
1696
1701NE3
1705
1715FL/A
1719BMA8/M
1719BMA8/R
1723
1726BM
1738
1743
1755
1748N
1748N
1771BM
1814M
1833XS/2

5980ET/B

€ 1.187,00 059801084

Assortment recommended in combination with C12 - 2029/VV - 2033P/VV - 2036TV

5980MQ

assortment of 46 tools

► Electrotechnical maintenance

Quantity/Description

- 7 single open end wrenches, 1000V 10 - 12 - 13 - 14 - 17 - 19 - 22 mm
- 1 adjustable wrench, 1000V 250 mm
- 6 hexagon nut spinners with handles \odot 5,5 - 6 - 7 - 8 - 10 - 13 mm
- 4 T-handle wrenches with hexagon male ends \odot 4 - 5 - 6 - 8 mm
- 1 bent knurled point spring tweezers, 1000V
- 1 slip joint pliers, boxed joint 250 mm
- 1 diagonal cutting nippers 1000V \nlessdot 160 mm
- 1 electrician's scissors
- 1 wire stripping pliers \nlessdot 160 mm
- 1 combination pliers 1000V \nlessdot 180 mm
- 1 extra-long bent flat nose pliers \nlessdot 160 mm
- 1 extra long needle nose pliers, 1000V, \bullet 160 mm
- 1 mains testing screwdriver \bullet
- 4 screwdrivers for cross head Phillips® screws, 1000V \oplus PH0x60 - PH1x80 - PH2x100 - PH3x150 mm
- 5 screwdrivers for headless slotted screws, 1000V \bullet 3x100 - 4x100 - 5,5x125 - 6,5x150 - 8x175 mm
- 1 engineer's hammer 300 g
- 1 soft face hammer Ø 35 mm
- 1 measuring tape 5 m
- 1 200 mm
- 1 mini - hacksaw frame, 1000V
- 2 utility knife, 1000V
- 1 soldering iron 30 W
- 1 high-brightness LED torch, made of sturdy anodized aluminium, up to 500 lumens
- 1 combination voltage and continuity tester

Beta N.
52MQ
110MQ
943MQ
951MQ
993MQ
1048MQ
1082MQ
1128MQ
1142MQ
1150MQ
1164MQ
1166MQ
1253
1272MQ
1274MQ
1370
1390
1692
1701NE/3
1725MQ
1777MQ
1814M
1833S
1847P

5980MQ

€ 1.610,00 059801257

Assortment recommended in combination with 2029/VV

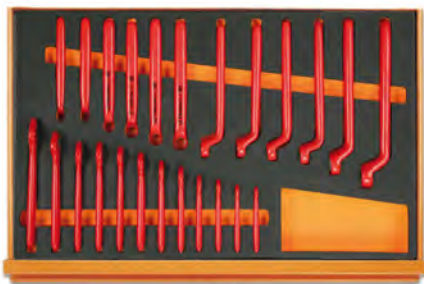

M49



M108



M161

5988 VHB-MQ

assortment of 66 tools in EVA foam trays

► Electrotechnical maintenance

Quantity/Description

- 12 single open end wrenches, 1000V 7-8-10-11-12-13-14-15-16-17-19-22 mm
- 12 single ring wrenches 7-8-10-11-12-13-14-15-16-17-19-22 mm
- 4 socket drivers for hexagon screws \odot 4-5-6-8 mm
- 11 bi-hex sockets \odot 7-8-10-11-12-13-14-15-16-17-19 mm
- 6 socket drivers for Torx® head screws \odot T15-T20-T25-T27-T30-T40
- 2 socket drivers with XZN® profile \odot 8-10 mm
- 1 3/8" drive extension 125 mm
- 1 3/8" drive extension 250 mm
- 1 3/8" drive, T-handle
- 1 3/8" drive reversible ratchet
- 1 electrician's scissors
- 1 slip joint pliers, boxed joint 250 mm
- 1 diagonal cutting nippers 1000V \nless 160 mm
- 1 combination pliers 1000V \equiv 180 mm
- 1 extra long flat nose pliers \equiv 160 mm
- 1 extra-long bent flat nose pliers \equiv 160 mm
- 4 screwdrivers for cross head Phillips® screws, 1000V \oplus PH0x60 - PH1x80 - PH2x100 - PH3x150 mm
- 4 screwdrivers for headless slotted screws, 1000V \bullet 2,5x75 - 3x100 - 4x100 - 5,5x125 mm
- 1 cable stripping knife, insulated

Beta N.	TR
52MQ	M49
89MQ	M49
910MQ/PE	M108
910MQ/B	M108
910MQ/TX	M108
910MQ/XZN	M108
910MQ/21	M108
910MQ/22	M108
910MQ/T	M108
910MQ/55	M108
1128MQ	M161
1048MQ	M161
1082MQ	M161
1150MQ	M161
1162MQ	M161
1164MQ	M161
1272MQ	M161
1274MQ	M161
1777MQ/U	M161

€

5988 VHB-MQ 2.660,00 059880300

Assortment recommended in combination with items RSC23T - RSC24 - RSC24A - RSC24AXL - RSC24L - RSC24L-CAB RSC28 - C37 - C39 - C39SM - C39MD - C39T - RSC55 - C59

5980EL/A

assortment of 57 tools

► Electronics

Quantity/Description

- 13 4÷14 mm
- 9 offset hexagon key wrenches \odot 1,5÷10 mm
- 1 bent point tweezers 130 mm
- 1 straight thin knurled point pin spring tweezers 150 mm
- 1 cross tweezers 155 mm
- 1 electrician's scissors, straight blades
- 1 wire stripping pliers \nless 160 mm
- 1 Extra-long needle nose pliers \bullet 160 mm
- 1 flat nose pliers \equiv
- 1 smooth half - round long bent needle nose pliers \bullet
- 1 combination pliers \bullet
- 1 diagonal flush cutting nippers \nless
- 1 diagonal cutting nippers \nless
- 1 screwholding screwdriver for slotted head screws \bullet 4x125 mm
- 1 screwholding screwdriver for cross head Phillips® screws \oplus PH0x125 mm
- 8 micro-screwdrivers
- 1 engineer's hammer 200 g
- 1 measuring tape 5 m
- 1 telescopic joint inspection mirror
- 3 needle files
- 1 spring puller
- 1 bristle brush
- 1 pen oiler
- 1 snap - off blade utility knife
- 1 self-locking round end knurled tool made of stainless steel
- 1 soldering iron 25 W
- 1 de - soldering pump
- 1 LED inspection torch, made of sturdy anodized aluminium

Beta N.
73/B13N
96N/SC9
991
992
998
1128BMX
1142BM
1166BM
1172BM
1178BM/P
1178BM
1185BM
1188BM
1250
1251
1257LPH/S8
1370
1692
1715
1720/S3
1723
1738
1756
1771
1002
1814M
1830T
1833XS/2

€

5980EL/A 853,00 059801081

Assortment recommended in combination with 2032TV - 2028/VV - 2033P/VV

5980EL/B

assortment of 98 tools

► Electronics

Quantity/Description	Beta N.
13 4+14 mm	73/B13N
9 offset hexagon key wrenches \odot 1,5+10 mm	96/SC9
8 offset key wrenches for Torx® head screws \odot T9 - T10 - T15 - T20 - T25 - T27 - T30 - T40	97TX/BG8
1 adjustable wrench 150 mm	111
18 set of 13 hexagon sockets and 5 accessories, 1/4" square drive	900/C13-5
1 straight thin knurled point spring tweezers 130 mm	990
1 bent point tweezers 130 mm	991
1 extra slim short end spring tweezers 120 mm	999A
1 electrician's scissors, straight blades	1128BMX
1 front wire stripping pliers, self - adjusting 170 mm	1149F
1 half-round needle nose pliers \equiv 180 mm	1150BM
1 flat nose pliers \equiv 140 mm	1172BM
1 smooth half - round long needle nose pliers \bullet 140 mm	1177BM
1 smooth half - round long bent needle nose pliers \bullet 140 mm	1178BM/P
1 diagonal flush cutting nippers, rounded tips \sphericalangle 120 mm	1184BM
1 diagonal flush cutting nippers, slim tips \sphericalangle 120 mm	1186BM
1 end flush oblique cutting nippers \sphericalangle	1191BM
8 micro-screwdrivers	1257LPH/S8
1 mains testing screwdriver \bullet	1253
1 screwdriver for slotted head screws, extra-short series \bullet 6,5x30 mm	1290N
3 screwdrivers for cross head Phillips® screws \oplus PH0x60 - PH1x80 - PH2x100 mm	1292
2 screwdriver for cross head Phillips® screws, extra-short series \oplus PH1x30 - PH2x30 mm	1292N
5 screwdrivers for headless slotted screws \bullet 2,5x60 - 3x75 - 4x100 - 5x125 - 6,5x150 mm	1294
1 engineer's hammer 200 g	1370
1 flexible graduated rule 150 mm	1682
1 engineer's scribe 220 mm	1688
1 measuring tape 5 m	1692
1 telescopic joint inspection mirror 670 mm	1715
1 Needle files \bullet	1720R
1 Needle files \blacktriangle	1720T
1 Needle files \blacksquare	1720P
1 spring puller	1723
1 bristle brush	1738
1 pen oiler	1756
1 snap - off blade utility knife	1771BM
1 fold - away knife	1777BM
1 self-locking round end knurled tool made of stainless steel	1002
1 soldering iron 25W	1814M
1 de - soldering pump	1830T
1 LED inspection torch, made of sturdy anodized aluminium	1833XS/2

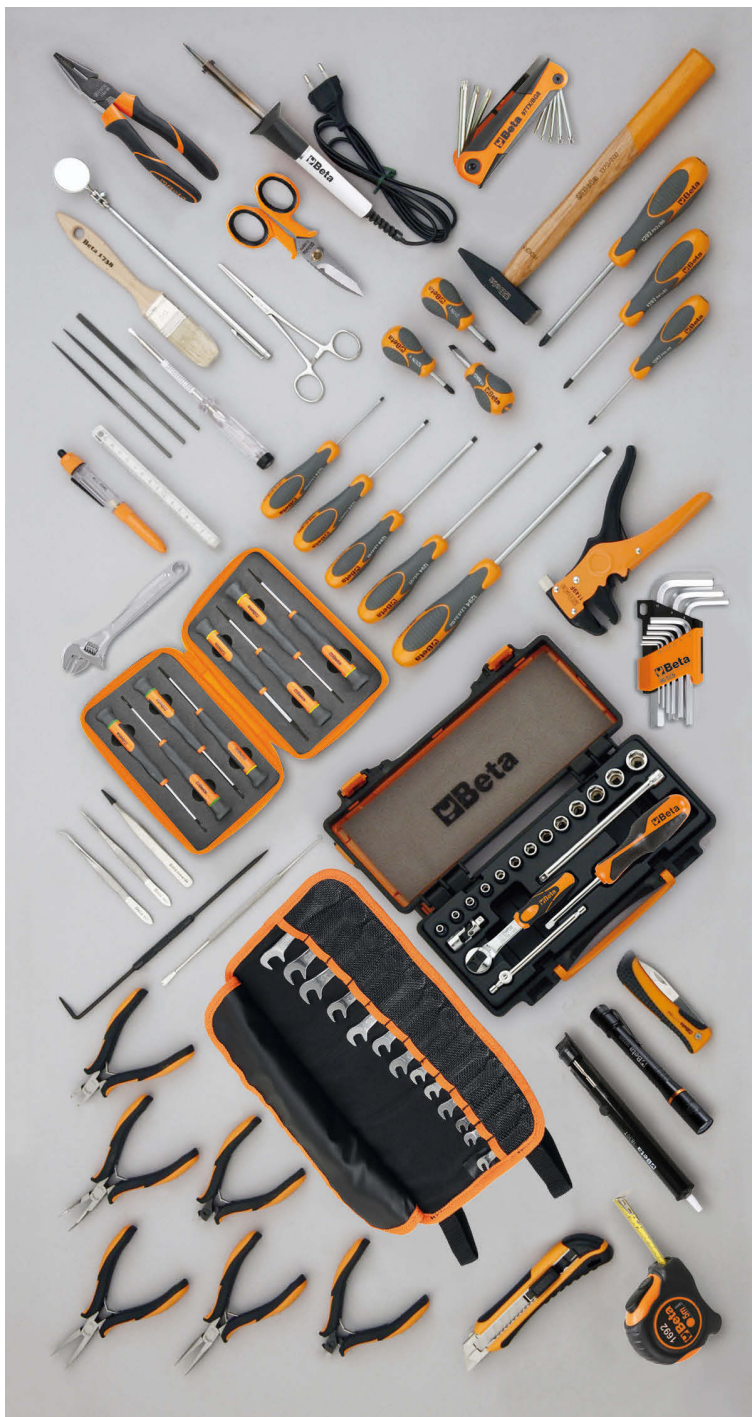

€ 

5980EL/B 1.205,00 059801082

Assortment recommended in combination with 2029/VV - 2033P/VV - 2036TV

5980ID

assortment of 35 tools

► Plumbing maintenance

Quantity/Description

- 1 flat chisels 150 mm
- 1 flat chisels, ribbed type 200 mm
- 12 double open end wrenches 6x7 - 8x9 - 10x11 - 12x13 - 14x15 - 16x17 - 18x19 - 20x22 - 21x23 - 24x27 - 25x28 - 30x32 mm
- 1 adjustable wrench 250 mm
- 1 pipe cutter for copper and light alloy pipes Ø 3+30 mm
- 1 pipe wrench Swedish pattern 320 mm
- 1 self - locking pliers 240 mm
- 1 tin snips 300 mm
- 1 electrician's scissors, straight blades
- 1 heavy duty combination pliers, bi-material handles, industrial finish = 180 mm
- 4 screwdriver for slotted head screws ● 3x75 - 4x100 - 5,5x150 - 8x150 mm
- 2 screwdriver for cross head Phillips® screws ⊕ PH1x80 - PH2x100 mm
- 1 engineer's hammer 300 g
- 1 measuring tape, made of fibre 2 m
- 1 measuring tape 5 m
- 1 spirit level, made of aluminium 200 mm
- 1 second-cut half-round files 200 mm
- 1 hacksaw frame, aluminium handle
- 1 Steel wire brush
- 1 Slip joint pliers boxed joints 250 mm

Beta N.

- 34
- 35
- 55/S12X
- 111
- 334
- 374
- 1052
- 1112
- 1128BMX
- 1150GBM
- 1201E
- 1202E
- 1370
- 1690F
- 1692
- 1696
- 1719BMA...M
- 1725
- 1737NX
- 1048



€

5980ID 552,00 059801085

Assortment recommended in combination with 2009N/VV

5902MT

assortment of 106 tools for agricultural, building and earth-moving machinery

► Car repairs

Quantity/Description

- 2 drift punches Ø 3 - 4 mm
- 2 pin punches Ø 6 - 8 mm
- 1 centre punch Ø 4 mm
- 2 flat chisels, ribbed type 150 - 200 mm
- 18 combination wrenches 6+14 - 17 - 19 - 22 - 24 - 27 - 30 - 32 - 36 - 41 mm
- 10 double ended offset ring wrenches 6x7 - 8x9 - 10x11 - 12x13 - 14x15 - 16x17 - 18x19 - 20x22 - 24x27 - 30x32 mm
- 10 offset hexagon key wrenches ○ 1,5+12 mm
- 17 1/2" square drive hexagon sockets ○ 10+22 - 24 - 27 - 30 - 32 mm
- 1 1/2" drive extension bar 125 mm
- 1 1/2" drive extension bar 255 mm
- 1 1/2" drive universal joint
- 1 1/2" drive sliding T-handle
- 1 1/2" drive push-through square ratchet ⊗
- 11 3/4" square drive hexagon socket ○ 22 - 24 - 27 - 30 - 32 - 36 - 41 - 46 - 50 - 55 - 60 mm
- 1 3/4" drive extension bar 200 mm
- 1 3/4" drive swivel handle
- 1 3/4" drive sliding T - handle
- 1 3/4" drive reversible ratchet ⊗
- 1 pry bar
- 1 Slip joint pliers boxed joints 250 mm
- 1 adjustable self locking pliers, curved jaws
- 1 heavy duty diagonal cutting nippers, bi-material handles, industrial finish ≡ 160 mm
- 1 electrician's scissors, straight blades
- 1 heavy duty combination pliers, bi-material handles, industrial finish = 180 mm
- 1 extra-long needle knurled nose pliers, bi-material handles, industrial finish ● 160 mm
- 4 screwdrivers for slotted head screws with hexagon bolsters ● 6,5x150 - 8x175 - 10x200 - 12x250 mm
- 3 screwdrivers for cross head Phillips® screws with hexagon bolsters ⊕ PH2x150 - PH3x175 - PH4x200 mm
- 1 ball pein hammer 900 g
- 1 soft face hammer Ø 35 mm
- 1 metric feeler gauge
- 1 three - cutting edges scraper 200 mm
- 5 Set of 5 second-cut files, with handles 200 mm
- 1 hacksaw frame, aluminium handle

Beta N.

- 30
- 31
- 32
- 35
- 42
- 90
- 96N/B10
- 920A
- 920/21
- 920/22
- 920/25
- 920/42
- 920/50
- 928A
- 928/21
- 928/36A
- 928/42
- 928/55
- 964
- 1048
- 1055
- 1084GBM
- 1128BMX
- 1150GBM
- 1166GBM
- 1260E
- 1262E
- 1377
- 1390
- 1708/20
- 1717B
- 1719BMA...S5
- 1725



€

5902MT 2.045,00 059021053

Assortment recommended in combination with RSC22 - RSC23 - RSC23C - C39T

5902MT/AS

assortment of 99 tools for earth-moving machinery (CATERPILLAR)



► Car repairs

Quantity/Description	Beta N.
2 drift punches Ø 3 - 4 mm	30
2 pin punches Ø 6 - 8 mm	31
1 centre punch Ø 4 mm	32
2 flat chisels, ribbed type 150 - 200 mm	35
20 combination wrenches 1/4+1.1/2"	42AS
6 double ended offset ring wrenches 1/4x5/16 - 3/8x7/16 - 1/2x9/16	90AS
5/8x3/4 - 11/16x13/16 - 7/8x15/16"	
11 offset hexagon key wrenches \odot 3/64+3/8"	96AS/B11
10 1/2" square drive bi - hex sockets \odot 7/16 - 1/2 - 9/16	920AS
5/8 - 11/16 - 3/4 - 13/16 - 7/8 - 15/16 - 1"	
1 1/2" drive extension bar 125 mm	920/21
1 1/2" drive extension bar 255 mm	920/22
1 1/2" drive universal joint	920/25
1 1/2" drive sliding T-handle	920/42
1 1/2" drive push-through square ratchet \oplus	920/50
12 hexagon hand sockets 1/4" \odot \square 3/4", 7/8 - 15/16 - 1 - 1.1/16 - 1.1/8 - 1.1/4 - 1.5/16 1.1/2 - 1.5/8 - 1.11/16 - 1.7/8 - 2"	928AS
1 3/4" drive extension bar 200 mm	928/21
1 3/4" drive swivel handle	928/36A
1 3/4" drive sliding T - handle	928/42
1 3/4" drive reversible ratchet \oplus	928/55
1 pry bar	964
1 Slip joint pliers boxed joints 250 mm	1048
1 adjustable self locking pliers, curved jaws	1055
1 heavy duty diagonal cutting nippers, bi-material handles, industrial finish ∇ 160 mm	1084GBM
1 electrician's scissors, straight blades	1128BMX
1 heavy duty combination pliers, bi-material handles, industrial finish \equiv 180 mm	1150GBM
1 extra-long needle knurled nose pliers, bi-material handles, industrial finish \bullet 160 mm	1166GBM
4 screwdrivers for slotted head screws with hexagon bolsters \bullet	1260E
6,5x150 - 8x175 - 10x200 - 12x250 mm	
3 screwdrivers for cross head Phillips® screws with hexagon bolsters \oplus	1262E
PH2x150 - PH3x175 - PH4x200 mm	
1 ball pein hammer 900 g	1377
1 soft face hammer Ø 35 mm	1390
1 metric feeler gauge 150 - 200 mm	1708/20
1 three - cutting edges scraper 200 mm	1717B
5 Set of 5 second-cut files, with handles 200 mm	1719BMA...S5
1 hacksaw frame, aluminium handle	1725

€ 

5902MT/AS 2.135,00 059021054

Assortment recommended in combination with RSC22 - RSC23 - RSC23C - C39T

5904VG/2M

assortment of 170 tools in EVA foam trays

► Car repairs

Quantity/Description

- 16 combination wrenches 6+21 mm
- 5 combination wrenches 22 - 24 - 27 - 30 - 32 mm
- 8 offset hexagon key wrenches \odot 2-2,5-3-4-5-6-7-8 mm
- 5 drivers for Torx® head screws, with handles \odot T10-T15-T20-T25-T30
- 7 hexagon bits \odot 4-5-6-7-8-10-12 mm
- 7 hexagon bits \odot 4-5-6-7-8-10-12 mm
- 5 bits with XZN® profile \odot 5-6-8-10-12 mm
- 5 bits with XZN® profile \odot 5-6-8-10-12 mm
- 7 bits for Torx® head screws \odot T20-T25-T30-T40-T45-T50-T55
- 6 bits for Torx® head screws \odot T25-T30-T40-T45-T50-T55
- 7 bits for Tamper Resistant Torx® head screws \odot T20-T25-T30-T40-T45-T50-T55
- 1 bit holder sockets for item 867
- 1 bit holder sockets for item 867
- 5 screwdrivers for slotted head screws \bullet 3x75 - 3,5x100 - 4x125 - 5,5x150 - 6,5x150 mm
- 3 screwdrivers for cross head Phillips® screws \oplus PH0x60 - PH1x80 - PH2x100 mm
- 1 screwdrivers for slotted head screws, extra-short series \bullet 4x30 mm
- 1 screwdrivers for cross head Phillips® screws, extra - short series \oplus PH1x30 mm
- 5 bits for slotted head screws, coloured \bullet 0,5x3 - 0,6x4,5 - 0,8x5,5 - 1x5,5 - 1,2x6,5 mm
- 8 hexagon bits for power drivers, coloured \odot 2 - 2,5 - 3 - 4 - 5 - 6 - 8 - 10 mm
- 5 bits for cross head Phillips® screws, coloured \oplus PH0 - PH1 - PH2 - PH3 - PH4
- 4 bits for cross head Pozidriv® - Supadriv® screws, coloured \oplus PZ1 - PZ2 - PZ3 - PZ4
- 11 bits for Torx® head screws, coloured \odot T6-T7-T8-T9-T10-T15-T20-T25-T27-T30-T40
- 8 bits for Tamper Resistant Torx® head screws, coloured \odot T9-T10-T15-T20-T25-T27-T30-T40
- 1 magnetic bit holder with handle 230 mm
- 1 reversible bit ratchet 100 mm
- 1 magnetic bit holder extension bar 80 mm
- 1 adaptors for drivers \blacksquare 1/4 - \square 1/4
- 2 flat chisels, ribbed type 100 - 200 mm
- 1 engineer's hammer 300 g
- 1 soft face hammer \varnothing 35 mm
- 1 1/2" wobble extension bar 125 mm
- 1 1/2" wobble extension bar 250 mm
- 1 1/2" drive universal joint
- 1 1/2" drive sliding T-handle
- 1 1/2" drive reversible ratchet \oplus
- 19 1/2" square drive hexagon sockets \odot 10+24 - 26 - 27 - 30 - 32 mm
- 1 half-round needle nose pliers \equiv 180 mm
- 1 Extra-long needle nose pliers \bullet 160 mm
- 1 Heavy-duty diagonal cutting nippers \blacktriangleleft 160 mm
- 1 circlip pliers straight, internal \odot 180 mm
- 1 circlip pliers bent, internal \odot 170 mm
- 1 circlip pliers straight, external \bullet 175 mm
- 1 circlip pliers bent, external \bullet 175 mm

Beta N.	TR
	42
	42
	96T
	97TTX
	867PE
	867PEL
	867XZN
	867XZNL
	867TX
	867TXL
	867TXL
	867TX
	8671
	8672
	1260
	1262
	1260N
	1262N
	860LP
	860PE
	860PH
	860PZ
	860TX
	860RTX
	851SR
	860/55
	882P
	8920
	35
	1370
	1390
	920AN/125
	920AN/250
	920/25
	920/42
	920/55
	920A
	1150BM
	1166BM
	1084BM
	1032
	1034
	1036
	1038



M05 M06 VP/M3



M50 M55 M86



M208 M85 M234



M83 M136 M145

€

5904VG/2M 1.615,00 059041198

Assortment recommended in combination with RSC24 - RSC24A - RSC24AXL - C37 - C39
RSC24L - RSC24L-CAB - C59 - C55 - C39T - C39SM - C39MD - RSC23T - RSC28

5904VG/2T

assortment of 99 tools in ABS thermoformed trays

► Car repairs

Quantity/Description

- 16 combination wrenches 6÷21 mm
- 5 combination wrenches 22 - 24 - 27 - 30 - 32 mm
- 19 1/2" square drive hexagon sockets ⌀ 10÷24 - 26 - 27 - 30 - 32 mm
- 5 1/2" drive, socket drivers for hexagon screws ⌀ 5 - 6 - 8 - 10 - 12 mm
- 1 1/2" drive extension bar 125 mm
- 1 1/2" drive extension bar 255 mm
- 1 1/2" drive universal joint
- 1 1/2" drive sliding T-handle
- 1 1/2" drive reversible ratchet Ⓢ
- 1 Slip joint pliers boxed joints 250 mm
- 1 self - locking pliers 240 mm
- 1 Heavy-duty diagonal cutting nippers < 160 mm
- 1 Extra-long needle nose pliers ● 160 mm
- 1 half-round needle nose pliers ≡ 180 mm
- 1 circlip pliers straight, internal Ⓞ 180 mm
- 1 circlip pliers straight, external ● 175 mm
- 1 circlip pliers bent, internal Ⓞ 170 mm
- 1 circlip pliers bent, external ● 175 mm
- 2 flat chisels, ribbed type 100 - 200 mm
- 1 engineer's hammer 300 g
- 1 soft face hammer Ø 35 mm
- 4 screwdrivers for slotted head screws ● 3x75 - 4x100 - 5,5x150 - 6,5x150 mm
- 3 screwdrivers for cross head Phillips® screws ● PH0x60 - PH1x80 - PH2x100 mm
- 8 double open end wrenches 6x7 - 8x9 - 10x11 - 12x13 - 14x15 - 16x17 - 18x19 - 20x22 mm
- 9 offset hexagon key wrenches Ⓞ 1,5 - 2 - 2,5 - 3 - 4 - 5 - 6 - 8 - 10 mm
- 6 offset hexagon key wrenches Ⓞ 2 - 2,5 - 3 - 4 - 5 - 6 mm
- 6 drivers for Torx® head screws, with handles Ⓞ T10 - T15 - T20 - T25 - T27 - T30

Beta N.	TR
	42
	42
	920A
	920ME
	920/21
	920/22
	920/25
	920/42
	920/55
	1048
	1052
	1084
	1084
	1166
	1150
	1032
	1036
	1034
	1038
	35
	1370
	1390
	1260
	1262
	55
	96/SC9
	96T
	97TTX
	T05
	T06
	T80
	T80
	T80
	T80
	T80
	T80
	T80
	T153
	T153
	T138
	T138
	T138
	T145
	T145
	T145
	T145
	T145
	T145
	T145
	T234
	T234
	T234
	T234
	T208
	T208
	T33
	T33
	T52
	T52
	T55



T05 T06 T80



T153 T138 T145 T234



T208 T33 T52 T55

€

5904VG/2T 1.380,00 059041191

Assortment recommended in combination with RSC24 - RSC24A - RSC24AXL - C37 - C39
RSC23T - C39T - RSC24L - RSC24L-CAB - C59 - C55 - RSC28 - C39SM - C39MD



5904VG/3

assortment of 132 tools

► Car repairs

Quantity/Description	Beta N.
6 Ø 2-8 mm	31/B6N
1 centre punch Ø 5 mm	32
1 flat chisels, ribbed type 200 mm	35
17 combination wrenches 6÷22 mm	42
8 double open end wrenches 6x7 - 8x9 - 10x11 - 12x13 - 14x15 - 16x17 - 18x19 - 20x22 mm	55
9 offset hexagon key wrenches ○ 1,5 - 2 - 2,5 - 3 - 4 - 5 - 6 - 8 - 10 mm	96N/SC9
11 offset hexagon key wrenches ○ 2÷10 mm	96T/SP11
13 offset key wrenches for Torx® head screws ○ T6÷T50	97TX/B13
1 adjustable wrench 300 mm	111
13 1/2" square drive hexagon sockets with rail ○ 10÷22 mm	920A/SB13
1 1/2" drive extension bar 125 mm	920/21
1 1/2" drive extension bar 255 mm	920/22
1 1/2" drive universal joint	920/25
1 1/2" drive sliding T-handle	920/42
1 1/2" drive push-through square ratchet Ⓢ	920/50
6 T - handle wrenches with swivelling socket ○ 8 - 10 - 12 - 13 - 17 - 19 mm	952
1 pry bar with handle 450 mm	965
2 circlip pliers straight, internal ○ 180 - 225 mm	1032
2 circlip pliers bent, internal ○ 170 - 210 mm	1034
2 circlip pliers straight, external ● 175 - 225 mm	1036
2 circlip pliers bent, external ● 175 - 220 mm	1038
1 Slip joint pliers boxed joints 250 mm	1048
1 self - locking pliers 240 mm	1057A
1 heavy duty diagonal cutting nippers, bi-material handles, industrial finish † 200 mm	1084GBM
1 toggle lever assisted end cutting nippers † 200 mm	1092V
1 tin snips 250 mm	1112
1 electrician's scissors, straight blades	1128BMX
1 heavy duty combination pliers, bi-material handles, industrial finish = 180 mm	1150GBM
4 screwdrivers for slotted head screws ● 3x75 - 4x100 - 5,5x125 - 6,5x150 mm	1260
1 screwdrivers for slotted head screws, extra-short series ● 6,5x30 mm	1260N
2 screwdrivers for slotted head screws with hexagon bolsters ● 8x175 - 10x200 mm	1260E
3 screwdrivers for cross head Phillips® screws Ⓢ PH0x100 - PH1x120 - PH2x100 mm	1262
1 screwdrivers for cross head Phillips® screws, extra - short series Ⓢ PH2x30 mm	1262N
1 screwdrivers for cross head Phillips® screws with hexagon bolsters Ⓢ PH3x175mm	1262E
1 screwdriver for cross head Phillips® screws, long series Ⓢ PH2x400 mm	1262L
1 screwdriver for headless slotted screws, long series ● 6,5x400 mm	1264L
1 engineer's hammer 500 g	1370
1 soft face hammer Ø 45 mm	1390
1 adjustable oil filter wrench	1491
1 metric feeler gauge	1708/20
5 Set of 5 second-cut files, with handles 200 mm	1719BMA..S5
1 hacksaw frame, aluminium handle	1726BM
1 metal oil can 200 cc	1751

€ 

5904VG/3 2.125,00 059041062

Assortment recommended in combination with RSC24 - RSC24A - RSC24AXL - C37 - C39 with 7 - 8 drawers
RSC24L - RSC24L-CAB - C59 - C55

5904VG/3T

assortment of 102 tools in ABS thermoformed trays

► Car repairs

Quantity/Description

- 21 combination wrenches 6-7-8-9-10-11-12-13-14-15-16-17
18-19-20-21-22-24-27-30-32 mm
- 8 double open end wrenches 6x7-8x9-10x11-12x13-14x15
16x17-18x19-20x22 mm
- 9 offset hexagon key wrenches \odot 1,5-10 mm
- 6 offset hexagon key wrenches \odot 2-2,5-3-4-5-6 mm
- 8 T - handle wrenches with swivelling socket \odot 7-8-10-12-13-14-17-19 mm
- 19 1/2" square drive hexagon sockets \odot 10-11-12-13-14-15-16-17-18-19
20-21-22-23-24-26-27-30-32 mm
- 1 1/2" drive extension bar 125 mm
- 1 1/2" drive extension bar 255 mm
- 1 1/2" drive universal joint
- 1 1/2" drive sliding T-handle 305 mm
- 1 1/2" drive reversible ratchet \oplus
- 1 Heavy-duty diagonal cutting nippers \llcorner 160 mm
- 1 half-round needle nose pliers \equiv 180 mm
- 1 Extra-long needle nose pliers \bullet 160 mm
- 1 circlip pliers straight, internal \odot 180 mm
- 1 circlip pliers bent, internal \odot 170 mm
- 1 circlip pliers straight, external \bullet 175 mm
- 1 circlip pliers bent, external \bullet 175 mm
- 1 self - locking pliers 240 mm
- 1 Slip joint pliers boxed joints 250 mm
- 7 screwdrivers for slotted head screws \bullet 2,5x50 - 3x75 - 3,5x100 - 4x125 - 5,5x100 - 5,5x150 -
6,5x150 mm
- 6 screwdrivers for cross head Phillips® screws \oplus PH0x60 - PH0x100 - PH1x80
PH1x120 - PH2x100 - PH2x150 mm
- 2 flat chisels, ribbed type 100-200 mm
- 1 engineer's hammer 300 g
- 1 soft face hammer \varnothing 35 mm
- 1 empty thermoformed tray

Beta N.	TR
42	T05-T06
55	T33
96/SC9	T33
96T	T52
952	T63
920A	T83
920/21	T83
920/22	T83
920/25	T83
920/42	T83
920/55	T83
1084BM	T137
1150BM	T137
1166BM	T137
1032	T145
1034	T145
1036	T145
1038	T145
1052	T153
1048	T153
1260	T199
1262	T202
35	T234
1370	T234
1390	T234
VP5	



T199 T202 T83



T145 T153 T137 T234



T52 T33 T05 T06



T63 VP5

€

5904VG/3T 1.595,00 059041510

Assortment recommended in combination with RSC24 - RSC24A - C37 - C39
RSC24L - RSC24L-CAB - C59 - C55 - RSC23T - C39T - RSC28 - C39SM - C39MD

5904VG/5T

assortment of 153 tools in ABS thermoformed trays

► Car repairs

Quantity/Description

- 5 1/2" drive, socket drivers for hexagon screws ○ 5 - 6 - 8 - 10 - 12 mm
- 1 1/2" drive extension bar 125 mm
- 1 1/2" drive extension bar 255 mm
- 1 1/2" drive universal joint
- 1 1/2" drive sliding T-handle
- 1 1/2" drive reversible ratchet Ⓢ
- 19 1/2" square drive hexagon sockets ○ 10÷24 - 26 - 27 - 30 - 32 mm
- 16 combination wrenches 6÷21 mm
- 5 combination wrenches 22 - 24 - 27 - 30 - 32 mm
- 8 T - handle wrenches with swivelling socket ○ 7 - 8 - 10 - 12 - 13 - 14 - 17 - 19 mm
- 1 empty thermoformed tray
- 1 circlip pliers straight, internal ○ 180 mm
- 1 circlip pliers bent, internal ○ 170 mm
- 1 circlip pliers straight, external ● 175 mm
- 1 circlip pliers bent, external ● 175 mm
- 7 screwdrivers for cross head Phillips® screws ● 2,5x50 - 3x75 - 3,5x100 - 4x125 - 5,5x100 - 5,5x150 - 6,5x150 mm
- 5 drivers for Torx® head screws, with handles ○ T25 - T27 - T30 - T40 - T45
- 6 offset hexagon key wrenches ○ 2 - 2,5 - 3 - 4 - 5 - 6 mm
- 8 double open end wrenches 6x7 - 8x9 - 10x11 - 12x13 - 14x15 - 16x17 - 18x19 - 20x22 mm
- 9 offset hexagon key wrenches ○ 1,5 - 2 - 2,5 - 3 - 4 - 5 - 6 - 8 - 10 mm
- 3 screwdrivers for cross head Phillips® screws ● 8x150 - 8x200 - 10x200 mm
- 2 screwdriver for slotted head screws, extra-short series ● 4x30 - 6,5x30 mm
- 6 screwdrivers for cross head Phillips® screws Ⓢ PH0x60 - PH0x100 - PH1x80 - PH1x120 - PH2x100 - PH2x150 mm
- 2 screwdrivers for cross head Phillips® screws Ⓢ PH3x150 - PH4x200 mm
- 1 screwdriver for cross head Phillips® screws, extra-short series Ⓢ PH1x30 - PH2x30 mm
- 2 flat chisels, ribbed type 100 - 200 mm
- 1 engineer's hammer 300 g
- 1 soft face hammer Ø 35 mm
- 1 half-round needle nose pliers = 180 mm
- 1 Extra-long needle nose pliers ● 160 mm
- 1 Heavy-duty diagonal cutting nippers † 160 mm
- 6 bits for Torx® head screws ○ T6÷T15
- 8 bits for Torx® head screws ○ T20÷T55
- 1 socket holder
- 1 socket holder
- 6 1/4" sockets for Torx® head screws ○ E4÷E10
- 7 1/2" sockets for Torx® head screws ○ E12÷E24
- 3 1/2" drive, socket drivers for Torx® head screws ○ T55L - T60 - T70L
- 1 Slip joint pliers boxed joints 250 mm
- 1 self - locking pliers 240 mm
- 1 empty thermoformed tray

Beta N.	TR
920ME	T80
920/21	T80
920/22	T80
920/25	T80
920/42	T80
920/55	T80
920A	T80
42	T05
42	T06
952	T63
VP6	VP6
1032	T145
1034	T145
1036	T145
1038	T145
1290	T170
1297TX	T176
96T	T52
55	T33
96N/SC9	T33
1290	T171
1290N	T171
1292	T172
1292	T173
1292N	T173
35	T234
1370	T234
1390	T234
1150BM	T137
1166BM	T137
1084BM	T137
861TX	T112
866TX	T112
895/1	T112
895/6	T112
900FTX	T112
920FTX	T112
920TX	T112
1048	T153
1052	T153
VP6	VP6



T80 T05 T06



T63 VP6



T145 T170 T176 T52



T33 T171 T172 T173



T234 T137 T112 T153

€

5904VG/5T

2.205,00 059041196

Assortment recommended in combination with RSC24 with 7 - 8 drawers - RSC24A with 7 - 8 drawers - RSC24AXL - C37 with 7 - 8 drawers - C39 with 7 - 8 drawers RSC24L - RSC24L-CAB - C59 - C55 - RSC23T - RSC28 - C39MD - C39SM



5905VG/1

assortment of 94 tools for car body repair shops

► Car repairs

Quantity/Description	Beta N.
1 drift punches Ø 4 mm	30
6 Ø 2 - 3 - 4 - 5 - 6 - 8 mm	31/BN
1 centre punch Ø 4 mm	32
1 flat chisels 150 mm	34
1 cape chisels, standard type 150 mm	36
17 combination wrenches 6÷22 mm	42
10 offset hexagon key wrenches \odot 1,5÷12 mm	96/B10
1 adjustable wrench 300 mm	111N
12 hi-torque hexagon nut spinners, long series \odot 4÷14 mm	943BX
1 pry bar with handle 450 mm	965
1 Slip joint pliers boxed joints 250 mm	1048
1 self - locking pliers 240 mm	1052
1 adjustable self locking pliers, aluminium jaws 280 mm	1060AL
1 heavy duty diagonal cutting nippers, bi-material handles, industrial finish \sphericalangle 160 mm	1084GBM
1 construction worker's pincers 250 mm	1098PL
1 compound leverage shears, straight blades	1122
1 electrician's scissors, straight blades	1128BMX
1 heavy duty combination pliers, bi-material handles, industrial finish \equiv 180 mm	1150GBM
1 screwdriver for Dzus® head screws \bullet	1201E/DZ
4 screwdrivers for slotted head screws \bullet 3x75 - 4x100 - 5,5x150 - 6,5x150 mm	1260
1 screwdrivers for slotted head screws, extra-short series \bullet 4x30 mm	1260N
2 screwdrivers for slotted head screws with hexagon bolsters \bullet 10x175 - 12x200 mm	1262
3 screwdrivers for cross head Phillips® screws \oplus PH0x60 - PH1x80 - PH2x100 mm	1262N
1 screwdrivers for cross head Phillips® screws, extra - short series \oplus PH1x30 mm	1262E
1 screwdrivers for cross head Phillips® screws with hexagon bolsters \oplus PH3x175 mm	1267TX
7 drivers for Torx® head screws \odot T6 - T8 - T10 - T15 - T20 - T25 - T30	1303
1 curved dolly 1350 g	1305
1 toe dolly	1306
1 heel dolly	1310
1 general purpose dolly	1313
1 buffer dolly	1326
1 curved angle spoon	1327
1 heavy duty spoon	1330
1 long double-ended spoon	1338A
1 body blade holder, with blade 9"	1342PM
1 extra flat chisel with hand guard	1345
1 body hammer	1357Z/32
1 Ø 32 mm	1370
1 engineer's hammer 300 g	1390
1 soft face hammer Ø 35 mm	1692
1 measuring tape 5 m	

€ 

5905VG/1 1.960,00 059051058

Assortment recommended in combination with C25



5905VG/2 assortment of 118 tools

► Car repairs

Quantity/Description	Beta N.
6 set of 2 drift punches, 1 centre punch, 2 flat chisels and 1 cape chisel in roll-up wallet made of polyester	38/B6N
13 combination wrenches 6-14 - 17 - 19 - 22 - 24 mm	42
13 double open end wrenches 6x7 - 8x9 - 10x11 - 12x13 - 14x15 - 16x17 - 18x19 - 20x22 - 21x23 - 24x26 - 25x28 - 27x29 - 30x32 mm	55
3 half - moon ring wrenches 11x13 - 14x17 - 19x22 mm	83
10 offset hexagon key wrenches \odot 1,5+12 mm	96N/B10
6 drivers for Torx® head screws, with handles \odot T10 - T15 - T20 - T25 - T30 - T40	97TTX
2 1/2" drive impact sockets \odot 17 - 19 mm	720
20 1/2" square drive hexagon sockets \odot 10+24 - 26 - 27 - 28 - 30 - 32 mm	920A
1 1/2" drive extension bar 125 mm	920/21
1 1/2" drive extension bar 255 mm	920/22
1 1/2" drive universal joint	920/25
1 1/2" drive sliding T-handle	920/42
1 1/2" drive reversible ratchet \odot	920/55
8 T - handle wrenches with swivelling socket \odot 7 - 8 - 10 - 11 - 13 - 14 - 17 - 19 mm	952
1 T - handle swivel spark plug wrenches	959
1 wheel nut wrench \odot 17x19x22x \blacksquare 1/2"	979
1 circlip pliers straight, internal \odot 180 mm	1032
1 circlip pliers bent, internal \odot 170 mm	1034
1 circlip pliers straight, external \bullet 175 mm	1036
1 circlip pliers bent, external \bullet 175 mm	1038
1 Slip joint pliers boxed joints 250 mm	1048
1 self - locking pliers 240 mm	1052
1 heavy duty diagonal cutting nippers, bi-material handles, industrial finish \ddagger 160 mm	1084GBM
1 compound leverage shears, straight blades 250 mm	1122
1 electrician's scissors, straight blades	1128BMX
1 heavy duty combination pliers, bi-material handles, industrial finish \blacksquare 180 mm	1150GBM
1 extra-long needle knurled nose pliers, bi-material handles, industrial finish \bullet 160 mm	1166GBM
8 screwdrivers for slotted head screws \bullet 2,5x50 - 3x75 - 3,5x100 - 4x125 - 5,5x125 - 6,5x150 - 8x200 - 10x200 mm	1260
2 screwdrivers for slotted head screws with hexagon bolsters \bullet 10x200 - 12x250 mm	1260E
1 screwdrivers for slotted head screws, extra-short series \bullet 6,5x30 mm	1260N
4 screwdrivers for cross head Phillips® screws \bullet PH0x60 - PH1x80 - PH2x100 - PH3x150 mm	1262
1 engineer's hammer 400 g	1370
1 soft face hammer \odot 35 mm	1390
1 adjustable oil filter wrench	1491
1 circuit tester 3+48 V	1498

€ 

5905VG/2 1.830,00 059051044

Assortment recommended in combination with C25

5908VG/2T

assortment of 212 tools in ABS thermoformed trays

► Car repairs

Quantity/Description



T05 T06 T31



T80 T145 T146



T167 T168
+96N +1771



T63 T209



T55 T110 T113 T236



T264 T234 T153 T138



T105 T106 VP6



Quantity/Description	Beta N.	TR
16 combination wrenches 6÷21 mm	42	T05
5 combination wrenches 22 - 24 - 27 - 30 - 32 mm	42	T06
5 pin punches Ø 2 - 3 - 4 - 5 - 6 mm	31	T31
1 centre punch Ø 4 mm	32	T31
12 double open end wrenches 6x7 - 8x9 - 10x11 - 12x13 - 14x15 - 16x17 - 18x19 - 20x22 - 21x23 - 24x26 - 27x29 - 30x32 mm	55	T31
9 offset hexagon key wrenches Ø 1,5 - 2 - 2,5 - 3 - 4 - 5 - 6 - 8 - 10 mm	96N/SC9	T31
5 1/2" drive, socket drivers for hexagon screws Ø 5 - 6 - 8 - 10 - 12 mm	920ME	T80
1 1/2" drive extension bar 125 mm	920/21	T80
1 1/2" drive extension bar 255 mm	920/22	T80
1 1/2" drive universal joint	920/25	T80
1 1/2" drive sliding T-handle	920/42	T80
1 1/2" drive reversible ratchet	920/55	T80
19 1/2" square drive hexagon sockets Ø 10÷24 - 26 - 27 - 30 - 32 mm	920A	T80
1 circlip pliers straight, internal Ø 180 mm	1032	T145
1 circlip pliers bent, internal Ø 170 mm	1034	T145
1 circlip pliers straight, external Ø 175 mm	1036	T145
1 circlip pliers bent, external Ø 175 mm	1038	T145
1 circlip pliers straight, internal Ø 140 mm	1032	T146
1 circlip pliers straight, internal Ø 225 mm	1032	T146
1 circlip pliers straight, external Ø 140 mm	1036	T146
1 circlip pliers straight, external Ø 225 mm	1036	T146
9 screwdrivers for slotted head screws ● 3x75 - 3x100 - 4x100 - 4x150 - 5,5x100 - 5,5x150 - 6,5x150 - 8x150 - 10x200 mm	1260	T167
2 screwdrivers for slotted head screws, extra-short series ● 4x30 - 6,5x30 mm	1260N	T167
7 screwdrivers for cross head Phillips® screws ● PH0x60 - PH0x100 - PH1x80 - PH1x120 - PH2x100 - PH2x150 - PH3x150 mm	1262	T168
2 screwdrivers for cross head Phillips® screws, extra - short series ● PH1x30 - PH2x30 mm	1262N	T168
8 T - handle wrenches with swivelling socket ○ 7 - 8 - 10 - 12 - 13 - 14 - 17 - 19 mm	952	T63
2 screwdriver for cross head Phillips® screws, long series ● PH1x400 - PH2x400 mm	1262L	T209
3 screwdriver for headless slotted screws, long series ● 3x300 - 4x400 - 5x400 mm	1264L	T209
6 drivers for Torx® head screws, with handles ○ T10-T15-T20-T25-T27-T30	97TTX	T55
13 1/2" drive impact sockets ○ 10-11-12-13-14-16-17-18-19-21-22-23-24 mm	720	T110
1 1/2" drive impact extension bar 125 mm	720/21	T110
5 socket drivers for hexagon screws ○ 5L - 6L - 7L - 8L - 10L	920PE	T113
4 1/2" drive, socket drivers for Torx® head screws ○ T40L - T45L - T55L - T70L	920TX	T113
3 socket drivers with XZN® profile ○ M6L - M8L - M12L	920XZN	T113
5 second cut files 200 mm	1719BMA8/S5	T236
1 adjustable oil filter wrench 110 mm	1491	T264
1 square oil drain plug socket ■ 10 mm	1494	T264
7 male hexagon oil drain plug sockets ○ 8-9-10-11-12-14-17 mm	1494E	T264
4 male square oil drain plug sockets ○ 8-9,5-12-13 mm	1494Q	T264
1 male triangular oil drain plug socket Δ	1494T	T264
1 male oil drain plug socket with XZN® profile ○	1494XZN	T264
1 oil plug wrenches	1496C	T264
2 flat chisels, ribbed type 100 - 200 mm	35	T234
1 engineer's hammer 300 g	1370	T234
1 soft face hammer Ø 35 mm	1390	T234
1 Slip joint pliers boxed joints 250 mm	1048	T153
1 self - locking pliers 240 mm	1052	T153
1 half-round needle nose pliers = 180 mm	1150	T138
1 Extra-long needle nose pliers ● 160 mm	1166	T138
1 Heavy-duty diagonal cutting nippers † 160 mm	1084	T138
11 3/4" square drive hexagon socket ○ 22-24-27-30-32-34-36-38-41-46-50 mm	928A	T105
1 3/4" drive extension bar 200 mm	928/21	T106
1 3/4" drive extension bar 380 mm	928/22	T106
1 3/4" drive sliding T - handle 450 mm	928/42	T106
1 3/4" drive reversible ratchet	928/55	T106
1 empty thermoformed tray	VP6	VP6
4 offset hexagon key wrenches Ø 13-14-17-19 mm	96N	
1 adjustable wrench 300 mm	111	
1 pry bar with handle	965	
1 tin snips 250 mm	1112	
1 electrician's scissors, straight blades	1128BMX	
1 engineer's hammer 1000 g	1370	
1 metric feeler gauge	1708/20	
1 telescopic magnet with flexible head	1712	
1 telescopic joint inspection mirror	1715	
1 three - cutting edges scraper 200 mm	1717B	
1 hacksaw frame, aluminium handle 440 mm	1726	
1 Steel wire brush	1737NX	
1 metal oil can 200 cl	1751	
1 snap - off blade utility knife	1771	

5908VG/2T 3.680,00 059081017

Assortment recommended in combination with RSC28

5910VG/3T

assortment of 202 tools in ABS thermoformed trays

► Car repairs

Quantity/Description

- 16 combination wrenches 6÷21 mm
- 5 combination wrenches 22 - 24 - 27 - 30 - 32 mm
- 6 double swivel end socket wrenches 8x9 - 10x11 - 12x13 - 14x15 - 16x17 - 18x19 mm
- 1 adjustable oil filter wrench 110 mm
- 1 square oil drain plug socket ■ 10 mm
- 7 male hexagon oil drain plug sockets ○ 8-9-10-11-12-14-17 mm
- 4 male square oil drain plug sockets ○ 8-9-5-12-13 mm
- 1 male triangular oil drain plug socket Δ
- 1 male oil drain plug socket with XZN® profile ○
- 1 oil plug wrenches
- 5 1/2" drive, socket drivers for hexagon screws ○ 5 - 6 - 8 - 10 - 12 mm
- 1 1/2" drive extension bar 125 mm
- 1 1/2" drive extension bar 255 mm
- 1 1/2" drive universal joint
- 1 1/2" drive sliding T-handle
- 1 1/2" drive reversible ratchet Ⓢ
- 19 1/2" square drive hexagon sockets ○ 10÷24 - 26 - 27 - 30 - 32 mm
- 1 circlip pliers straight, internal ○ 180 mm
- 1 circlip pliers bent, internal ○ 170 mm
- 1 circlip pliers straight, external ● 175 mm
- 1 circlip pliers bent, external ● 175 mm
- 1 circlip pliers straight, internal ○ 140 mm
- 1 circlip pliers bent, internal ○ 225 mm
- 1 circlip pliers straight, external ● 140 mm
- 1 circlip pliers bent, external ● 225 mm
- 6 drivers for Torx® head screws, with handles Ⓢ T10-T15-T20-T25-T27-T30
- 12 swivel end ratcheting combination wrenches
8 - 9 - 10 - 11 - 12 - 13 - 14 - 15 - 16 - 17 - 18 - 19 mm
- 1 half-round needle nose pliers = 180 mm
- 1 Extra-long needle nose pliers ● 160 mm
- 1 Heavy-duty diagonal cutting nippers † 160 mm
- 1 slip joint pliers, push button alignment 240 mm
- 1 self - locking pliers 240 mm
- 8 T - handle wrenches with swivelling socket ○ 7 - 8 - 10 - 12 - 13 - 14 - 17 - 19 mm
- 9 screwdrivers for slotted head screws ● 3x75 - 3,5x100 - 4x100 - 4x150 - 5,5x100 - 5,5x150 - 6,5x150 - 8x150 - 10x200 mm
- 2 screwdrivers for slotted head screws, extra-short series ● 4x30 - 6,5x30 mm
- 6 pin punches
- 7 screwdrivers for cross head Phillips® screws Ⓢ PH0x60 - PH0x100 - PH1x80 - PH1x120 - PH2x100 - PH2x150 - PH3x150 mm
- 2 screwdrivers for cross head Phillips® screws, extra - short series Ⓢ PH1x30 - PH2x30 mm
- 1 adjustable wrench 250 mm
- 1 1/2" drive swivel T-handle
- 6 T-handle wrenches with hexagon male ends ○ 2,5-3-4-5-6-8 mm
- 4 T handle wrenches with swivelling hexagon male ends ○ 4-5-6-8 mm
- 2 engineer's hammer 300-500 g
- 2 screwdriver for cross head Phillips® screws, long series Ⓢ PH1x400 - PH2x400 mm
- 3 screwdriver for headless slotted screws, long series ● 3x300 - 4x400 - 5x400 mm
- 9 ball head offset hexagon key wrenches ○
- 1 click-type torque wrenches with reversible ratchets Ⓢ 8 ÷ 60 Nm
- 1 click-type torque wrenches with reversible ratchets Ⓢ 60 ÷ 330 Nm
- 12 impact sockets
- 1 adaptor, 1/2" female and 3/8" male drives
- 1 assortment of 12 sockets and 5 accessories 3/4"
- 3 lever with articulated, flat, curved head
- 1 dead blow hammer Ø 50 mm
- 1 Reversible impact wrench, made from composite material Ⓢ

Beta N.	TR
42	T05
42	T06
80	T79
1491	T264
1494	T264
1494E	T264
1494Q	T264
1494T	T264
1494XZN	T264
1496C	T264
920ME	T80
920/21	T80
920/22	T80
920/25	T80
920/42	T80
920/55	T80
920A	T80
1032	T145
1034	T145
1036	T145
1038	T145
1032	T146
1034	T146
1036	T146
1038	T146
97TTX	T55
142SN	T46
1150BM	T137
1166BM	T137
1084BM	T137
1047	T151
1057A	T151
952	T63
1260	T167
1260N	T167
31/B6	
1262	T168
1262N	T168
111	T59
920/40	T59
951	T59
953	T59
1370	T59
1262L	T209
1264L	T209
96BPC/SC9	
666N/5	
666N/30	
720/C12	
910/16	
928A/C12	
966/C3	
1392	
1927P	



T05 T06 T79 T264



T80 T145 T146

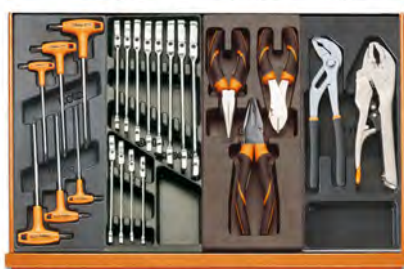

T55 T46 T137 T151

T63



T167 T168 + 96BPC/SC9 + 31/B6

T59



T209



5910VG/3T

€ 5.200,00 059101068

Assortment recommended for use with item C30M

5935VG/1MB

assortment of 98 tools for tool chest C35, in EVA foam trays



MB12



MB39



MB46

► Car repairs

Quantity/Description

- 21 combination wrenches 6-7-8-9-10-11-12-13-14-15-16-17-18-19-20-21-22-24-27-30-32 mm
- 8 double open end wrenches 6x7-8x9-10x11-12x13-14x15
16x17-18x19-20x22 mm
- 1 Slip joint pliers boxed joints 250 mm
- 4 screwdrivers for slotted head screws ● 3x75-4x100-5x125-6,5x150 mm
- 3 screwdrivers for cross head Phillips® screws ⊕ PH0x60-PH1x80--PH2x100 mm
- 6 drivers for Torx® head screws ⊙ T8-T10-T15-T20-T25-T30
- 9 ball head offset hexagon key wrenches ⊖
- 6 offset hexagon key wrenches ⊖ 2-2,5-3-4-5-6
- 1 self - locking pliers 240 mm
- 19 1/2" square drive hexagon sockets ⊖ 10-11-12-13-14-15-16-17-18-19
20-21-22-23-24-26-27-30-32 mm
- 1 1/2" drive extension bar 125 mm
- 1 1/2" drive extension bar 250 mm
- 1 1/2" drive universal joint
- 1 1/2" drive sliding T-handle
- 1 1/2" drive reversible ratchet ⊗
- 5 socket drivers for hexagon screws ⊖ 5-6-8-10-12 mm
- 1 circlip pliers straight, internal ⊖ 180 mm
- 1 circlip pliers bent, internal ⊖ 170 mm
- 1 circlip pliers straight, external ● 175 mm
- 1 circlip pliers bent, external ● 175 mm
- 1 flat chisels, ribbed type 200 mm
- 1 Heavy-duty diagonal cutting nippers ⊚ 160 mm
- 1 half-round needle nose pliers = 180 mm
- 1 Extra-long needle nose pliers ● 160 mm
- 1 engineer's hammer 500 g
- 1 soft face hammer 35 mm

Beta N.	TR
42	MB12
55	MB12
1048	MB12
1260	MB46
1262	MB46
1267TX	MB46
96BPC/SC9	MB46
96T	MB46
1052	MB46
920A	MB39
920/21	MB39
920/22	MB39
920/25	MB39
920/42	MB39
920/55	MB39
920PE	MB39
1032	MB39
1034	MB39
1036	MB39
1038	MB39
35	MB39
1084BM	MB39
1150BM	MB39
1166BM	MB39
1370	MB39
1390	MB39

€

5935VG/1MB 1.460,00 059351321

Assortment recommended in combination with C35

5940SBK

assortment of 125 tools

► Motorcycle repairs

Quantity/Description

- 1 drift punches Ø 2 mm
- 1 centre punch Ø 4 mm
- 1 flat chisels 125 mm
- 10 combination wrenches 6 - 7 - 8 - 10 - 11 - 12 - 13 - 14 - 17 - 19 mm
- 6 double open end wrenches 6x7 - 8x9 - 10x11 - 12x13 - 14x15 - 16x17 mm
- 9 offset hexagon key wrenches ⊖ 1,5 - 2 - 2,5 - 3 - 4 - 5 - 6 - 8 - 10 mm
- 1 click-type torque wrenches with reversible ratchets ⊗ 3/8", 8÷60 Nm
- 54 assortment of 52 hexagon bits, 10 mm, and 2 accessories
- 17 assortment of 12 sockets and 5 accessories
- 1 adaptor, 1/2" female and 3/8" male drives
- 2 spark plug socket ⊖ 14 - 16 mm
- 1 extra - long nose pliers ● 283 mm
- 2 circlip pliers straight, internal ⊖ 140 - 180 mm
- 1 circlip pliers straight, external ● 140x1,3 mm
- 1 diagonal cutting nippers,
slip-proof double layer PVC coated handles,
industrial finish ⊚ 160 mm
- 1 electrician's scissors, straight blades
- 1 heavy duty combination pliers,
slip-proof double layer PVC coated handles,
industrial finish = 180 mm
- 1 screwdriver for Dzus® head screws ●
- 4 screwdriver for slotted head screws ● 3x75 - 4x100 - 5,5x100 - 6,5x150 mm
- 3 screwdriver for cross head Phillips® screws ⊕ PH0x60 - PH1x80 - PH2x100 mm
- 1 circuit testing screwdriver ●
- 1 engineer's hammer 300 g
- 1 adjustable oil filter wrench
- 1 metric feeler gauge
- 1 mini hacksaw frame
- 1 Brass wire brush
- 1 plastic oil can 250 cc

Beta N.	TR
30	
32	
34	
42	
55	
96/SC9	
666N/5	
867/C52	
920A/C12X	
910/16	
956C	
1009L/A	
1032	
1036	
1082G	
1128BM	
1150G	
1201E/DZ	
1201E	
1202E	
1254	
1370	
1491	
1708/13	
1725CR	
1737	
1754	

€

5940SBK 1.169,00 059401082

Assortment recommended for use with items C41S - C41H - C42S - C42H - C42S - C41S



MC21



MC12



5941VU/M

assortment of 64 tools for trolley C41H, in EVA foam trays

► Universal use

Quantity/Description

- 16 combination wrenches 6-7-8-9-10-11-12-13-14-15-16-17-18-19-21-22 mm
- 9 offset hexagon key wrenches \odot
- 1 measuring tape 5 m
- 19 1/2" square drive hexagon sockets \odot 10-11-12-13-14-15-16-17-18-19-20-21-22-23-24-26-27-30-32 mm
- 1 1/2" drive universal joint
- 1 1/2" drive sliding T-handle
- 1 1/2" drive reversible ratchet \odot
- 2 1/2" wobble extension bar 125-250 mm
- 1 adjustable wrench 250 mm
- 1 Slip joint pliers boxed joints 250 mm
- 1 \ddagger 160 mm
- 1 electrician's scissors, straight blades 145 mm
- 1 heavy duty combination pliers, bi-material handles, industrial finish \equiv 180 mm
- 1 extra-long needle knurled nose pliers, bi-material handles, industrial finish \bullet 160 mm
- 3 screwdrivers for slotted head screws \bullet 3,5x100-5,5x125-6,5x150 mm
- 3 screwdrivers for cross head Phillips® screws \oplus PH0-PH1-PH2
- 1 engineer's hammer 300 g
- 1 snap - off blade utility knife 18 mm

Beta N.	TR
42	MC12
96/SC9	MC12
1692/5	MC12
920A	MC21
920/25	MC21
920/42	MC21
920/55	MC21
920AN	MC21
111	
1048	
1082GBM	
1128BMX	
1150GBM	
1166GBM	
1260	
1262	
1370	
1771	

5941VU/M

€ 798,00 059411002

Assortment recommended in combination with C41H

Beta

5945VUM

assortment of 231 tools in EVA foam trays

► Universal use

Quantity/Description

- 21 combination wrenches 6-7-8-9-10-11-12-13-14-15-16-17-18-19-20-21-22-24-27-30-32 mm
- 9 ball head offset hexagon key wrenches \odot 1,5-2-2,5-3-4-5-6-8-10 mm
- 8 offset hexagon key wrenches \odot 2-2,5-3-4-5-6-7-8 mm
- 1 engineer's hammer 300 g
- 1 soft face hammer \varnothing 35
- 2 flat chisels, ribbed type 100-200 mm
- 5 second cut files 200 mm
- 1 socket holder \odot 1/4 - \square 1/4
- 1 socket holder \odot 1/4 - \square 3/8
- 1 socket holder \odot 5/16 - \square 1/2
- 13 1/4" hexagon sockets \odot 4-4,5-5-5,5-6-7-8-9-10-11-12-13-14 mm
- 9 hexagon hand sockets, long series \odot 5-6-7-8-9-10-11-12-13 mm
- 5 1/4" socket drivers for hexagon screws \odot 3-4-5-6-7 mm
- 4 socket drivers for slotted head screws \bullet 0,8x4-1x5,5x1,2x6,5-1,2x8 mm
- 4 socket drivers for cross head Phillips® screws \oplus PH1-PH2-PH3-PH4
- 7 socket drivers for Torx® head screws \odot T10-T15-T20-T25-T27-T30-T40
- 1 adaptor, 1/4" female and 3/8" male drives \square 1/4 - \blacksquare 3/8
- 1 1/4" drive extension bar 50 mm
- 1 1/4" drive extension bar 100 mm
- 1 1/4" drive extension bar 150 mm
- 1 1/4" drive universal joint
- 1 1/4" drive spinner handle 176 mm
- 1 1/4" drive swivel T-handle 115 mm
- 1 1/4" reversible ratchet \odot 125 mm
- 17 hexagon hand sockets 3/8" \odot 6-7-8-9-10-11-12-13-14-15-16-17-18-19-20-21-22 mm
- 1 adaptor, 3/8" female and 1/4" male drivers \square 3/8 - \blacksquare 1/4
- 1 adaptor, 1/2" female and 3/8" male drives \square 3/8 - \blacksquare 1/2
- 1 extension bar - 3/8" 125 mm
- 1 extension bar - 3/8" 250
- 1 3/8" drive universal joint
- 1 3/8" drive sliding T - handle 210 mm
- 1 3/8" drive reversible ratchet \odot 200 mm
- 21 1/2" square drive hexagon sockets \odot 8-10-11-12-13-14-15-16-17-18-19-20-21-22-23-24-26-27-28-30-32 mm
- 1 adaptor, 1/2" female and 3/8" male drives \square 1/2 - \blacksquare 3/8
- 1 1/2" drive universal joint
- 1 1/2" wobble extension bar 125 mm
- 1 1/2" wobble extension bar 250 mm
- 1 1/2" drive sliding T-handle 305 mm
- 1 1/2" drive reversible ratchet \odot 275 mm
- 3 3/8" square drive spark plug sockets \odot 16 mm (5/8")-17,8 (11/16")-20,8 (13/16")
- 5 drivers for Torx® head screws, with handles \odot T10-T15-T20-T25-T30
- 1 Heavy-duty diagonal cutting nippers \ddagger 160 mm
- 1 half-round needle nose pliers \equiv 180 mm
- 1 Extra-long needle nose pliers \bullet 160 mm
- 1 circlip pliers straight, internal \odot 19+60 mm
- 1 circlip pliers bent, internal \odot 19+60 mm
- 1 circlip pliers straight, external \bullet 19+60 mm
- 1 circlip pliers bent, external \bullet 19+60 mm
- 1 Slip joint pliers boxed joints 250 mm
- 1 self - locking pliers 240 mm
- 38 microscrewdriver with 36 interchangeable 4-mm bits and magnetic extension
- 6 screwdriver for slotted head screws \bullet 04x2,5x50-0,5x3x75-0,8x4x100-1,0x5,5x125-1,2x6,5x150-1,2x8x200 mm
- 1 screwdriver for slotted head screws, extra-short series \bullet 0,8x4x30 mm
- 4 screwdriver for cross head Phillips® screws \oplus PH0x60-PH1x80PH2x100PH3x150 mm
- 1 screwdriver for cross head Phillips® screws, extra-short series \oplus PH1x30 mm
- 12 screwdrivers for Torx® head screws, with handles \odot T06-T07-T08-T09-T10-T15-T20-T25-T27-T30-T40-T45
- 1 mains testing screwdriver \bullet 0,5x3,5x100 mm

Beta N.	TR
42	MM11
96BPC/SC9	MM11
96T	MM61
1370	MM61
1390	MM61
35	MM61
1719BMA8/S5	MM61
895/1	MM105
895/3	MM105
895/6	MM105
900	MM105
900L	MM105
900ME	MM105
900LP	MM105
900PH	MM105
900TX	MM105
900/16	MM105
900/20	MM105
900/20L	MM105
900/21	MM105
900/25	MM105
900BG/30	MM105
900/42	MM105
900/55	MM105
910A	MM105
910/15	MM105
910/16	MM105
910/21	MM105
910/22	MM105
910/25	MM105
910/42	MM105
910/55	MM105
920A	MM105
920/15	MM105
920/25	MM105
920AN	MM105
920AN	MM105
920/42	MM105
920/55	MM105
956E	MM105
97TTX	MM140
1084BM	MM140
1150BM	MM140
1166BM	MM140
1032	MM140
1034	MM140
1036	MM140
1038	MM140
1048	MM140
1052	MM140
1256/C36-2	MM140
1201E	MM210
1201EN	MM210
1202E	MM210
1202EN	MM210
1207E/TX	MM210
1253	MM210



MM11



MM61



MM105



MM140



MM210

€

5945VUM 2.490,00 059451001

Assortment recommended in combination with item C45



5954VG

assortment of 138 tools

► Car repairs

Quantity/Description	Beta N.
5 pin punches Ø 2-3-4-5-6 mm	31
1 centre punch Ø 4 mm	32
1 flat chisels 125 mm	34
18 combination wrenches 6÷22 - 24 mm	42
8 double open end wrenches 6x7 - 8x9 - 10x11 - 12x13 - 14x15 - 16x17 - 18x19 - 20x22 mm	55
3 double ended offset ring wrenches 12x13 - 14x15 - 17x19 mm	90
13 offset hexagon key wrenches \odot 2÷10 - 12 mm	96
4 1/2" drive impact sockets \odot 17 - 19 - 21 - 22 mm	720
20 1/2" square drive hexagon sockets \odot 10-11-12-13-14-15-16-17-18-19-20-21-22-23-24-26-27-28-30-32 mm	920A
1 1/2" drive extension bar	920/21
1 1/2" drive extension bar	920/22
1 1/2" drive universal joint	920/25
1 1/2" drive sliding T-handle	920/42
1 1/2" drive reversible ratchet \odot	920/55
3 hi-torque hexagon nut spinners, long series \odot 8 - 10 - 13 mm	943BX
10 T - handle wrenches with swivelling socket \odot 6 - 7 - 8 - 10 - 11 - 12 - 13 - 14 - 17 - 19 mm	952
3 spark plug socket \odot 16 - 17,8 - 20,8 mm	956C
1 pry bar	964
1 circlip pliers straight, internal \odot	1032
1 circlip pliers bent, internal \odot	1034
1 circlip pliers straight, external \bullet	1036
1 circlip pliers bent, external \bullet	1038
1 Slip joint pliers boxed joints 250 mm	1048
1 self - locking pliers 240 mm	1052
1 adjustable self locking pliers, long jaws 175 mm	1058
1 Diagonal cutting nippers \angle 160 mm	1082BM
1 electrician's scissors, straight blades	1128BMX
1 half-round needle nose pliers \equiv 180 mm	1150BM
1 Extra-long needle nose pliers \bullet 160 mm	1166BM
1 circuit testing screwdriver \bullet 6÷24V	1254
1 screwdrivers for slotted head screws \bullet 8 x 200 mm	1260
1 screwdrivers for slotted head screws, extra-short series \bullet 6,5x30 mm	1260N
1 screwdrivers for cross head Phillips® screws \oplus 8 x 150 mm	1262
1 screwdrivers for cross head Phillips® screws, extra - short series \oplus PH2x30 mm	1262N
5 drivers for Torx® head screws \odot T8 - T10 - T15 - T20 - T25	1267TX
8 set of screwdrivers	1263/D8
1 engineer's hammer 300 g	1370
1 dead blow hammer Ø 35 mm	1392
1 brake spring pliers 210 mm	1470
1 crimping pliers for non insulated terminals	1603
1 measuring tape 5 m	1692
1 metric feeler gauge	1708/20
1 flexible magnetic pick-up tool 1,8 kg	1712E/2
6 needle files 160 mm	1720/B6
1 plastic oil can 150 cc	1754

€ 

5954VG 2.120,00 059541054

Assortment recommended in combination with C54VG



5957VG

assortment of 174 tools

► Car repairs

Quantity/Description	Beta N.
6 pin punches Ø 2 - 3 - 4 - 5 - 6 - 8 mm	31/SP6
6 2 drift punches, 1 centre punch, 3 flat chisels with metal holder	38/SP6
17 combination wrenches 6-7-8-10-11-12-13-14-15-16-17-19-21-22-24-27-30 mm	42
12 double open end wrenches 6x7 ÷ 30x32 mm	55/S12X
8 offset hexagon key wrenches 2 ÷ 10 mm	96T/S8
1 offset hexagon key wrenches Ø 2,5 ÷ 12 mm	96N/G7
8 offset key wrenches, for Torx® head screws ⌘ T9 ÷ T40	97TX/SC8
5 offset key wrenches with XZN® profile Ø M5 ÷ M12	98XZN/B5
1 adjustable wrench 250 mm	111
1 click-type torque wrenches with reversible ratchets ⌚ 1/2", 40÷200 Nm	666N/20
13 1/2" square drive hexagon sockets with rail ⌘ 10÷22 mm	920A/SB13
8 1/2" square drive hexagon sockets with rail ⌘ 23÷32 mm	920A/SB8
4 1/2" socket drivers for slotted head screws ● 1,2x6,5 - 1,2x8 - 1,6x9 - 2x12 mm	920LP
3 1/2" socket drivers for Phillips® screws ⌚ PH2 - 3 - 4	920PH
1 1/2" drive extension bar 125 mm	920/21
1 1/2" drive extension bar 255 mm	920/22
1 1/2" drive universal joint	920/25
1 1/2" drive sliding T-handle	920/42
1 1/2" drive reversible ratchet ⌚	920/55
2 1/2" drive impact sockets ⌘ 17 - 19 mm	720
10 T - handle wrenches with swivelling socket ⌘ 7 - 8 - 10 - 11 - 12 - 13 - 14 - 15 - 17 - 19 mm	952
3 T - handle swivel spark plug wrenches 14 - 16 - 20,8 mm	959
1 pry bar	963
1 wheel nut wrench ⌘ ■ 1/2" - 17 - 19 - 22 mm	979
2 circlip pliers straight, internal ⌘ 140 - 180 mm	1032
2 circlip pliers bent, internal ⌘ 130 - 170 mm	1034
2 circlip pliers straight, external ● 140x1,3 - 175 mm	1036
2 circlip pliers bent, external ● 135x1,3 - 175 mm	1038
1 Slip joint pliers boxed joints 250 mm	1048
1 self - locking pliers 240 mm	1052
1 Diagonal cutting nippers ⌘ 160 mm	1082BM
1 Heavy-duty diagonal cutting nippers ⌘ 160 mm	1084BM
1 toggle lever assisted end cutting nippers ⌘ 180 mm	1092V
1 tin snips 250 mm	1112
1 electrician's scissors, straight blades	1128BMX
1 half-round needle nose pliers = 180 mm	1150BM
1 Extra-long needle nose pliers ● 160 mm	1166BM
1 Extra-long bent needle nose pliers ● 200 mm	1168BM
2 screwdrivers for slotted head screws ● 8x200 - 10x200 mm	1260
1 screwdrivers for cross head Phillips® screws ⌚ PH3x150 mm	1262
8 set of screwdrivers	1263/D8
2 engineer's hammer 300 - 600 g	1370
1 soft face hammer Ø 35 mm	1390
11 roller stud extractors M5÷M16 mm	1433/C11
1 adjustable oil filter wrench	1491
1 circuit tester	1498
1 measuring tape 5 m	1692
1 metric feeler gauge	1708/20
1 flexible magnetic pick-up tool 1,8 kg	1712E/2
1 two cutting edges scraper 200 mm	1717A
1 three - cutting edges scraper 200 mm	1717B
5 second cut files 200 mm	1719BMA8/S5
1 hacksaw frame, aluminium handle	1725
1 metal oil can 200 cc	1751
1 snap - off blade utility knife	1771
1 sliding gauge	1650



€

5957VG 3.700,00 059571007

Assortment recommended for use with items C57S A - C57S B - C57SP - C55PSP

SOFT MODULES

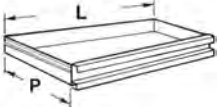
Assortment of tools in thermoformed trays,
designed for roller cabs

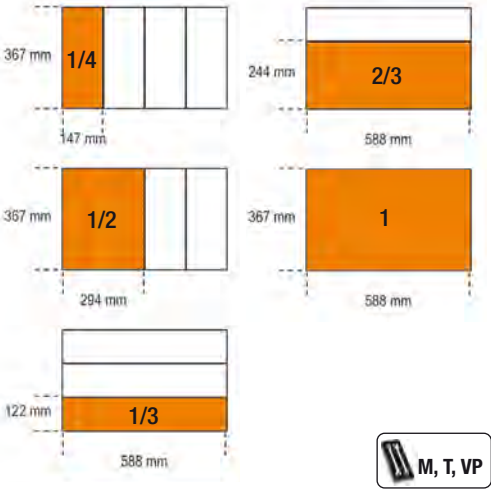
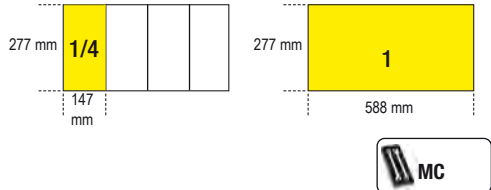
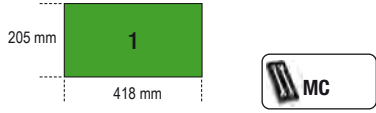
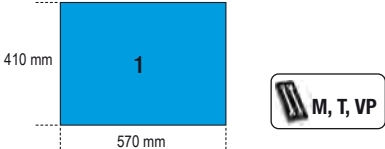
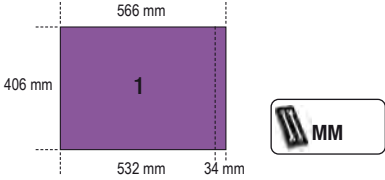
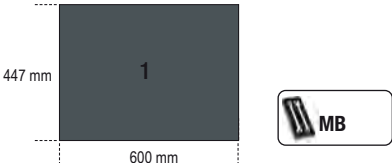
		
RSC23T RSC24 RSC24A RSC24AXL RSC24L/7 RSRSC28 C30M C37 C39 C39T C39MD C39SM C50S C57S C59 RSC55		479÷488 493÷503
RSC22 RSC23 RSC23C C27S		489 503
C41S C41H		489
C04TSS C38 C38T		492 503
C45PRO		491
C35		489÷491

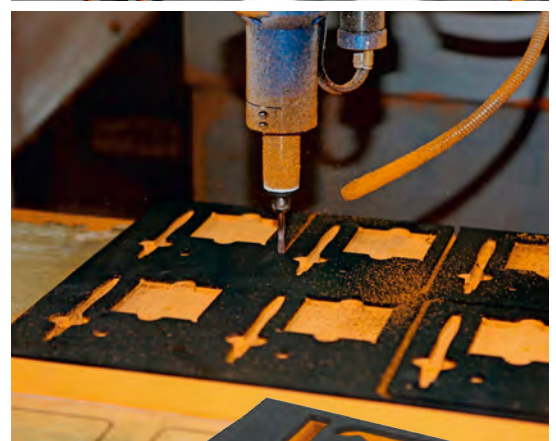

M01

22



42 6-7-8-9-10-11-12-13-14-15-16-17-18-19-20-21-22-24-27-30-32-36 mm

4,5 kg



M01	403,00	€	1	024500001
MV10	54,50	€	1	024510010

M02

26



42 6-7-8-9-10-11-12-13-14-15-16-17-18-19-20-21-22-23-24-25-26-27-28-29-30-32 mm

6,3 kg



M02	456,00	€	1	024500002
MV02	54,50	€	1	024510002

M05

16



42 6-7-8-9-10-11-12-13-14-15-16-17-18-19-20-21 mm

1,5 kg



M05	198,50	€	1	024500005
MV15	28,50	€	1	024510015

M06

5



42 22-24-27-30-32 mm

2,1 kg



M06	140,00	€	1	024500006
MV16	38,50	€	1	024510016

M13

11



42SLIM 8-10-11-12-13-14-15-16-17-18-19 mm

1,2 kg



M13	143,50	€	1	024500013
MV13	28,50	€	1	024510013

M25

40



42 6-7-8-9-10-11-12-13-14-15-16-17-18-19-21-22-24-27 mm
 90 6x7-8x9-10x11-12x13-14x15-16x17-18x19 mm
 123Q1/4
 123Q3/8
 123Q1/2
 142 8-9-10-11-12-13-14-15-16-17-18-19 mm

5,1 kg



M25	651,00	€	1	024500025
MV25	54,50	€	1	024510073

M30

31



55 6x7-8x9-10x11-12x13-14x15-16x17-18x19-20x22-21x23-24x27-30x32 mm
 90 6x7-8x9-10x11-12x13-14x15-16x17-18x19-20x22-21x23-24x27-30x32 mm
 96BPC/SC9 1,5-2-2,5-3-4-5-6-8-10 mm

4,2 kg



M30	377,00	€	1	024500030
MV30	54,50	€	1	024510030



M31

27



42AS 1/4-9/32-5/16-3/8-7/16-1/2-9/16-19/32-5/8-11/16-3/4-13/16-7/8-15/16-1-1-1/16-1-1/8-1-1/4

96BP/AS-SC9 1/16-3/32-1/8-5/32-3/16-7/32-1/4-5/16-3/8

4,5 kg



M31	396,00	€	1	024500031
MV31	54,50	€	1	024510031

M33

17

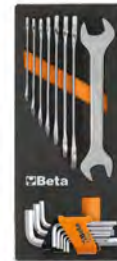

55 6x7-8x9-10x11-12x13-14x15-16x17-18x19-20x22 mm
 96/SC9 1,5÷10 mm

1,1 kg



M33	91,00	€	1	024500033
MV33	28,50	€	1	024510033

M38

4



55 21x23-24x26-27x29-30x32 mm

1,7 kg



M38	76,50	€	1	024500038
MV38	38,50	€	1	024510038



M39

36



- 31 2-3-4-5-6-8 mm
- 32 4 mm
- 55 6x7-8x9-10x11-12x13-14x15-16x17-18x19-20x22-21x23-24x26-25x28-27x29-30x32 mm
- 96/SC12 2-2,5-3-3,5-4-4,5-5-6-7-8-9-10 mm
- 96 12-14-17-19 mm

5,7 kg



M39	315,00	1	024500039
MV39	54,50	1	024510039

M40

7



- 90 6x7-8x9-10x11-12x13-14x15-16x17-18x19 mm

810 g



M40	102,00	1	024500040
MV40	28,50	1	024510040

M44

12



- 141 8-9-10-11-12-13-14-15-16-17-18-19 mm

1,3 kg



M44	261,00	1	024500044
MV44	28,50	1	024510044

M45

12



- 142 8-9-10-11-12-13-14-15-16-17-18-19 mm

1,3 kg



M45	297,00	1	024500045
MV45	28,50	1	024510045

M46

12



- 142SN 8-9-10-11-12-13-14-15-16-17-18-19 mm

1,4 kg



M46	352,00	1	024500046
MV46	28,50	1	024510046

M49

24

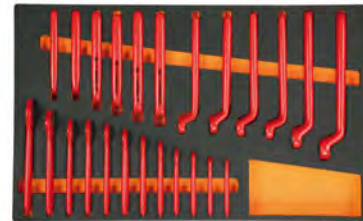

- 52MQ 7-8-10-11-12-13-14-15-16-17-19-22 mm
- 89MQ 7-8-10-11-12-13-14-15-16-17-19-22 mm

3,3 kg



M49	1.035,00	1	024500049
MV49	54,50	1	024510049

M50

8



- 96T 2-2,5-3-4-5-6-7-8 mm

1,1 kg



M50	121,50	1	024500050
MV50	38,50	1	024510051

M52

5



- 96T 2,5-3-4-5-6 mm

330 g



M52	70,50	1	024500052
MV52	28,50	1	024510052

M53

5



- 96TBP 2,5-3-4-5-6 mm

350 g



M53	74,50	1	024500053
MV52	28,50	1	024510052

M55

5



- 97TTX T10-T15-T20-T25-T30

330 g



M55	78,00	1	024500055
MV55	28,50	1	024510055



M60

23



- 96T 2-2,5-3-4-5-6-7-8-10 mm
- 97BTX/SC8 T9-T10-T15-T20-T25-T27-T30-T40
- 944BX 5-6-7-8-10-13 mm

1,9 Kg

M60	€ 349,00	1	024500060
MV60	€ 54,50	1	024510060

M62

21

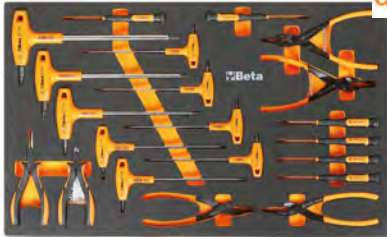

- 97TTX T10-T15-T20-T25-T27-T30-T40-T45-T50
- 1032 180 mm
- 1034 170 mm
- 1036 175 mm
- 1038 175 mm
- 1177BM 140 mm
- 1188BM 125 mm
- 1257LP 2-2,5-3-3,5 mm
- 1257PH 0-00

2,3 kg

M62	€ 416,00	1	024500875
MV62	€ 54,50	1	024510875

M63

8



- 952 7-8-10-12-13-14-17-19 mm

3,4 kg

M63	€ 322,00	1	024500063
MV63	€ 54,50	1	024510063

M65

16

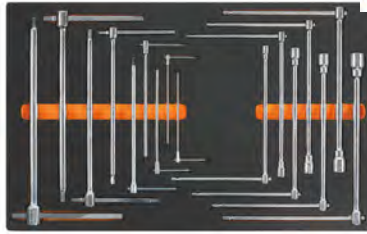

- 950 8-10-12-13-14-17-19 mm
- 951 2,5-3-4-5-6-8-10-12-14 mm

3,6 Kg

M65	€ 486,00	1	024500065
MV65	€ 54,50	1	024510065

M69

9



- 951 2,5-3-4-5-6-8 10-12-14 mm

1,8 kg

M69	€ 276,00	1	024500069
MV69	€ 38,50	1	024510069

M75

16



- 933 7-8-9-10-11-12-13-14-15 16-17-18-19-21-22-24 mm

5,5 kg

M75	€ 411,00	1	024500075
MV75	€ 54,50	1	024510075

M78

17



- 80 6x7-8x9-10x11-12x13-14x15-16x17-18x19 mm
- 920/36A
- 965 450 mm
- 1052 240 mm
- 1058 175 mm
- 1481PL/A
- 1481PL/B
- 1481PL/C
- 1650 150 mm
- 1708/20
- 1716P

4,4 kg

M78	€ 627,00	1	024500878
MV77	€ 54,50	1	024510878

M79

6



- 80 8x9-10x11-12x13-14x15 16x17-18x19 mm

1,3 kg

M79	€ 275,00	1	024500079
MV79	€ 28,50	1	024510079

M82

29



- 920A 10-11-12-13-14 15-16-17-18-19 20-21-22-23-24 26-27-30-32 mm
- 920ME 5-6-8-10-12 mm
- 920AN/125 125 mm
- 920AN/250 250 mm
- 920/25
- 920/42 305 mm
- 920/55

4,1 kg

M82	€ 407,00	1	024500082
MV82	€ 38,50	1	024510082



M83



- 920A 10-11-12-13-14
15-16-17-18-19
20-21-22-23-24
26-27-30-32 mm
- 920AN/125 125 mm
- 920AN/250 250 mm
- 920/25 255 mm
- 920/42 305 mm
- Ⓢ 920/55

3,7 kg 12"

M83	327,00	1	024500083
MV83	38,50	1	024510083

M85



- 851SR 230 mm
- 860LP 0,5x3 - 0,6x4,5
- 0,8x5,5 - 1x5,5 -
1,2x6,5 mm
- 860PE 2 - 2,5 - 3 - 4 - 5 - 6 - 8
- 10 mm
- ⊕ 860PH PH0 - PH1 - PH2 -
PH3 - PH4
- ⊕ 860PZ PZ1 - PZ2 - PZ3 - PZ4
- ⊕ 860TX T6-T7-T8-T9-T10-T15-
T20-T25-T27-T30-T40
- ⊕ 860RTX T9-T10-T15-T20-T25-
T27-T30-T40
- 860/55 100 mm
- 882P 80 mm
- 892 ■ 1/4 - □ 1/4

450 g 1/4

M85	184,00	1	024500085
MV85	28,50	1	024510085

M86



- 867PE 4-5-6-7-8-10-12 mm
- 867PE/L 4-5-6-7-8-10-12 mm
- 867XZN 5-6-8-10-12 mm
- 867XZN/L 5-6-8-10-12 mm
- ⊕ 867TX T20-T25-T30-T40-
T45-T50-T55
- ⊕ 867TX/L T25-T30-T40-T45-
T50-T55
- ⊕ 867RTX T20-T25-T30-T40-
T45-T50-T55
- 867/1
- 867/2

1,4 kg 10"

M86	130,50	1	024500086
MV86	28,50	1	024510086

M91



- 900 4-4,5-5-5,5-6-7-8-9-
10-11-12-13-14 mm
- 900ME 2,5-3-4-5-6-8 mm
- 900/20 50 mm
- 900/21 150 mm
- 900/25 □ 1/4 - ■ 1/4
- 900BG/30
- 900/42
- Ⓢ 900/55

560 g 1 1/4"

M91	221,50	1	024500091
MV90	28,50	1	024510090

M92



- 910A 6-7-8-9-10-11-12-13-
14-15-16-17-18-19-20-
21-22 mm
- 910/21 125 mm
- 910/22 250 mm
- 910/25
- 910/42
- Ⓢ 910/55

1,5 kg 3/8"

M92	246,50	1	024500092
MV92	28,50	1	024510092

M94



- 900AS/L 3/16-7/32-1/4-9/32-
5/16-11/32-3/8-7/16-
1/2-9/16
- 900AS 3/16-7/32-5/32-1/4-
9/32-5/16-11/32-3/8-
7/16-1/2-9/16
- 900AN 50-100mm
- 900/25
- Ⓢ 900/55
- 900/42

930 g 1 1/4"

M94	257,00	1	024500094
MV94	28,50	1	024510094

M96



- 920A/AS 3/8-7/16-1/2-9/16-
19/32-5/8-11/16-3/4-
25/32-13/16-7/8-
15/16-1-1.1/16-1.1/18-
1.3/16-1.1/4
- 920/25
- 920AN 125-250mm
- 920/42
- Ⓢ 920/55

3,8 kg 1 1/2"

M96	334,00	1	024500096
MV96	38,50	1	024510096

M100



- 895/1
- 895/3
- 895/6
- 900 4-4,5-5,5-6-7-8-9-10-11-12-13-14 mm
- 900L 5-6-7-8-9-10-11-12-13 mm
- 900ME 3-4-5-6-7 mm
- 900LP 0,8x4-1x5,5-1,2x6,5-1,2x8 mm
- ⊕ 900PH PH1-PH2-PH3-PH4
- ⊕ 900TX T10-T15-T20-T25-T27-T30-T40
- 900/20 50 mm
- 900/20L 100 mm
- 900/21 150 mm
- 900/25
- 900BG/30
- 900/42
- Ⓢ 900/55
- 920A 8-10-11-12-13-14-15-16-17-18-19-20
21-22-23-24-26-27-28-30-32 mm
- 920/15
- 920/25
- 920AN/125 125 mm
- 920AN/250 250 mm
- 920/42
- Ⓢ 920/55
- 920FTX 10-12-14-16-18-20-22-24 mm
- 920AL 10-12-13-14-15-16-17-18-19-21-22

6,7 Kg 1 1/4" 1 1/2"

M100	1.128,00	1	024500100
MV100	54,50	1	024510100



M105

116



- 900 4-4,5-5-5,5-6-7-8-9-10-11-12-13-14 mm
- 900L 5-6-7-8-9-10-11-12-13 mm
- 96BPC/SC9 1,5-2-2,5-3-4-5-6-8-10 mm
 - 895/1
 - 895/3
 - 895/6
- 900ME 3-4-5-6-7 mm
- 900LP 0,8x4-1x5,5-1,2x6,5-2x8 mm
- ⊕ 900PH PH1-PH2-PH3-PH4
- ⊕ 900TX T10-T15-T20-T25-T27-T30-T40
 - 900/16 □ 1/4 - ■ 3/8
 - 900/... 50-100-150 mm
 - 900/25
 - 900BG/30
 - 900/42
- ⊕ 900/55
- 910A 6-7-8-9-10-11-12-13-14-15-16-17-18-19-20-21-22 mm
 - 910/15 □ 3/8 - ■ 1/4
 - 910/16 □ 3/8 - ■ 1/2
 - 910/21 125 mm
 - 910/22 250 mm
 - 910/42
- ⊕ 910/55
- 920A 8-10-11-12-13-14-15-16-17-18-19-20-21-22-23-24-26-27-28-30-32 mm
 - 920/15 □ 1/2 - ■ 3/8
 - 920/25
 - 920AN 125 - 250 mm
 - 920/42
- ⊕ 920/55
- 956E 16-17,8-20,8 mm

7,7 kg

14" 38" 12"



M105	1.215,00	1	024500871
MV105	54,50	1	024510871

Beta

M108

27

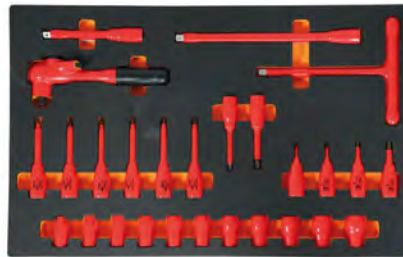

- 910MQ/PE 4-5-6-8 mm
- 910MQ/B 7-8-10-11-12-13-14-15-16-17-19 mm
- ⊕ 910MQ/TX T15-T20-T25-T27-T30-T40
- 910MQ/XZN 8-10 mm
 - 910MQ/21 125 mm
 - 910MQ/22 250 mm
 - 910MQ/T
 - 910MQ/55

2,7 kg



M108	1.153,00	1	024500108
MV108	54,50	1	024510108

M110

36



- ⊕ 850MQ
- ⊕ 860TX/A10
- 920MQ/A 8-9-10-11-12-13-14-15-16-17-18-19-20 mm
- 920MQ/PE 5-6-8-10-12 mm
 - 920MQ/21 125 mm
 - 920MQ/22 250 mm
 - 920MQ/55A
- 943MQ 6-7-8-10 mm

3,1 kg



M110	1.160,00	1	024500110
MV110	54,50	1	024510110

M112

32



- ⊕ 861TX ● 1/4-T6+T15
- ⊕ 866TX ● 5/16-T20+T55
- 895/1 ○ 1/4x□1/4
- 895/6 ○ 5/16x□1/2
- ⊕ 900FTX □ 1/4-E4+E10
- ⊕ 920FTX □ 1/2-E12+E24
- ⊕ 920TX □ 1/2-T55-L-T60-T70L

1,3 kg

14" 12"



M112	288,00	1	024500112
MV112	28,50	1	024510112

M115

54



- ⊕ 666N 40+200 Nm
- 920A 13-14-15-16-17-18-19-20-21-22-24-26-27-30-32 mm
- ⊕ 920FTX 12-14-16-18-20-22-24 mm
- 920PE 6-7-8-8L-10-10L-12-12L-14-14L
- ⊕ 920TX T20-T25-T27-T30-T40-T45-T50-T55-T60-T20L-T25L-T27L-T30L-T40L-T45L-T50L
 - 920/21 125 mm
 - 920/22 255 mm
 - 920/25
 - 920/42 305 mm
- ⊕ 920/55

7,8 Kg

12"



M115	1.073,00	1	024500115
MV115	54,50	1	024510115

M120

75



- 920A 10-11-12-13-14-15-16-17-18-19-20-21-22-24-26-27-30-32 mm
 - 920AN/125 125 mm
 - 920AN/250 250 mm
 - 920/25
 - 920/42
- 920AL 10-12-13-14-15-16-17-18-19-22-24-27-30-32 mm
- ⊕ 920FTX 10-12-14-16-18-20-22-24 mm
- ⊕ 920/55
- 920PE 5-5L-6-6L-7-7L-8-8L-10-10L-12-12L-14-14L
- ⊕ 920TX T20-T25-T27-T30-T40-T45-T50-T55-T60-T20L-T25L-T27L-T30L-T40L-T45L-T50L

6,9 Kg

12"



M120	1.205,00	1	024500120
MV120	54,50	1	024510120

Beta

M121

46



- 920BP 5L-6L-8L-10L-5XL-6XL-8XL mm
- ⊗ 920TX T20-T25-T27-T30-T40L-T45L-T50L-T55L-T60L-T70L
- 920XZN 4-5-6-6L-8-8L-10-10L-12-12L-14-14L-16-18 mm
- ⊗ 920ES 7-9-10-11-12L-14L-16L-7XL-9XL-10XL-11XL-12XL-14XL-16XL mm

920/36A

12"

6,3 Kg

M121	€ 1.140,00	1	024500121
MV121	€ 54,50	1	024510121

M125

68



- 910AL 8-9-10-11-12-13-14-15-16-17-19-21-22 mm
- 920PE 5-6-6L-7-8-8L-10-10L-12-12L mm
- ⊗ 920FTX E12-E14-E16-E18-E20-E22-E24
- ⊗ 920TX T20-T25-T27-T30-T30L-T40-T40L-T45-T50-T50L-T55-T60-T60L
- 920XZN 5-6-6L-8-8L-10-10L-12L mm
- 920AL 10-12-13-14-15-16-17-18-19-21-22-23-24-27-30-32 mm
- 1692/5 5 m

38" 12"

7,9 kg

M125	€ 1.189,00	1	024500872
MV125	€ 54,50	1	024510872

M126

26



- 928A 19-21-22-24-26-27-28-30-32-34-35-36-38-41-46 mm
- 928ME 14-17-19-22 mm
- 928/15 □ 3/4 - ■ 1/2
- 928/16 □ 3/4 - ■ 1
- 928/21 200 mm
- 928/22 380 mm
- 928/25 380 mm
- 928/42 450 mm
- ⊗ 928/55

34"

12,4 kg

M126	€ 898,00	1	024500126
MV126	€ 54,50	1	024510126

M127

23



- 728 19-21-22-24-27-30-32-33-34-35-36-38-40-41-46
- ⊗ 728FTX 20-22-24 mm
- 728/15 □ 3/4 - ■ 1/2
- 728/16 □ 3/4 - ■ 1
- 728/21 175 mm
- 728/22 250 mm
- 728/25

34"

12,5 kg

M127	€ 853,00	1	024500127
MV127	€ 54,50	1	024510127

M128

50

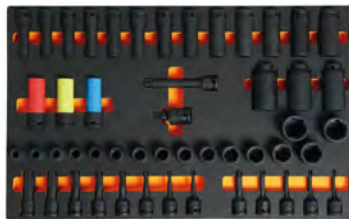

- 720 10-11-12-13-14-15-16-17-18-19-21-22-24-27-30-32 mm
- 720L 10-11-12-13-14-15-16-17-18-19-21-22-24-27-30-32 mm
- ⊗ 720TX T30-T40-T45-T50-T55
- 720ME 5-6-8-10-12-14-17-19 mm
- 720LC 17-19-21 mm
- 720/21 125 mm
- 720/25

12"

8,9 kg

M128	€ 881,00	1	024500128
MV128	€ 54,50	1	024510128

M129

13



- 1032 180 mm
- 1034 170 mm
- 1036 175 mm
- 1038 175 mm
- 1048 250 mm
- 1052 240 mm
- 1082BM 160 mm
- 1098 220 mm
- 1112 250 mm
- 1128BM
- 1150BM 180 mm
- 1166BM 160 mm
- 1168BM 160 mm

3,4 Kg

M129	€ 401,00	1	024500129
MV130	€ 54,50	1	024510130

M133

3



- 1082G 160 mm
- 1150G 180 mm
- 1166G 160 mm

650 g

M133	€ 76,50	1	024500133
MV133	€ 28,50	1	024510133

M134

3



- 1082GBM 160 mm
- 1150GBM 180 mm
- 1166GBM 160 mm

750 g

M134	€ 97,00	1	024500134
MV134	€ 28,50	1	024510134

M135

3



- 1082MQ 160 mm
- 1150MQ 180 mm
- 1166MQ 160 mm

750 g

M135	€ 163,00	1	024500135
MV135	€ 28,50	1	024510135

M136

3



- 1084BM 160 mm
- 1150BM 180 mm
- 1166BM 160 mm

750 g

M136	€ 110,50	1	024500136
MV131	€ 28,50	1	024510131

M137



- 1084 160 mm
- 1150 180 mm
- 1166 160 mm

650 g



M137	€ 90,50	1	024500137
MV132	€ 28,50	1	024510132

M145



- 1032 180 mm
- 1034 170 mm
- 1036 175 mm
- 1038 175 mm

640 g



M145	€ 124,50	1	024500145
MV145	€ 28,50	1	024510145

M153



- 1048 250 mm
- 1052 240 mm

1 kg



M153	€ 76,00	1	024500153
MV153	€ 28,50	1	024510153

M161



- 1128MQ
- 1048MQ 250 mm
- 1082MQ 160 mm
- 1150MQ 180 mm
- 1162MQ 160 mm
- 1164MQ 160 mm
- 1272MQ PH0x60 - PH1x80 - PH2x100 - PH3x150 mm
- 1274MQ 2,5x75 - 3x100 - 4x100 - 5,5x125 mm
- 1777MQ/U

3,0 kg



M161	€ 476,00	1	024500161
MV161	€ 54,50	1	024510161

M162

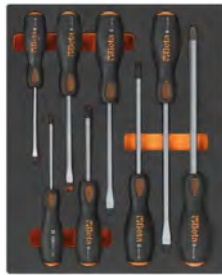

- 1241 5,5x100-6,5x125-8x150-10x200 mm
- 1242 PH1x100-PH2x100-PH3x150-PH4x200 mm

1,4 kg



M162	€ 134,00	1	024500162
MV162	€ 38,50	1	024510162

M166



- 860MIX/A31
- 1048 250 mm
- 1082BM 160 mm
- 1150BM 180 mm
- 1162BM 160 mm
- 1290 3x75-4x100-5,5x100-6,5x150-8x150 mm
- 1290N 6,5x30 mm
- 1292 4,5x80-6x100-8x150 mm
- 1292N 6x30 mm
- 1297TX T20-T25-T27-T30

2,9 kg



M166	€ 408,00	1	024500879
MV165	€ 54,50	1	024510874

M170



- 1290 2,5x50
3x75
3,5x100
4x125
5,5x100
5,5x150
6,5x150 mm

500 g



M170	€ 70,00	1	024500170
MV170	€ 28,50	1	024510170

M172



- 1292 PH0x60
PH0x100
PH1x80
PH1x120
PH2x100
PH2x150 mm

450 g



M172	€ 64,00	1	024500172
MV172	€ 28,50	1	024510172

M174



- 1297TX T8-T10-T15-T20-T25-T30

450 g



M174	€ 94,00	1	024500174
MV174	€ 28,50	1	024510174

M180



- 1290 3x75
4x100
5,5x150
6,5x150 mm
- 1292 PH0x60
PH1x80
PH2x100 mm

500 g



M180	€ 73,00	1	024500180
MV180	€ 28,50	1	024510180



M195

25



- 1260 2,5x50-3x75-4x100-5,5x125-6,5x150-8x200 mm
- 1260N 4x30 mm
- ⊕ 1262 PH0x60-PH1x80-PH2x100-PH3x150 mm
- ⊕ 1262N PH1X30 mm
- ⊖ 1267TX T6-T7-T8-T9-T10-T15-T20-T25-T27-T30-T40-T45
- 1253 3,5x100 mm

📦 2,3 kg

M195	€ 286,00	📦 1	📄 024500195
MV195	€ 54,50	📦 1	📄 024510195

M199

7



- 1260 2,5x50-3x75-3,5x100-4x125-5,5x100-5,5x150-6,5x150 mm

📦 500 g

M199	€ 57,50	📦 1	📄 024500199
MV199	€ 28,50	📦 1	📄 024510199

M202

6



- ⊕ 1262 PH0x60-PH0x100-PH1x80-PH1x120-PH2x100-PH2x150 mm

📦 450 g

M202	€ 53,00	📦 1	📄 024500202
MV202	€ 28,50	📦 1	📄 024510202

M204

6



- ⊖ 1267TX T8-T10-T15-T20-T25-T30

📦 450 g

M204	€ 73,50	📦 1	📄 024500204
MV204	€ 28,50	📦 1	📄 024510204

M208

10



- 1260 3x75-3,5x100-4x125-5,5x150-6,5x150 mm
- ⊕ 1262 PH0x60-PH1x80-PH2x100 mm
- 1260N 4x30 mm
- ⊕ 1262N PH1x30 mm

📦 750 g

M208	€ 84,50	📦 1	📄 024500208
MV208	€ 38,50	📦 1	📄 024510208

M209

10



- 1260N 4x30 mm
- 1264 2,5x60 - 3x100 - 4x125 - 5x150 - 6,5x150 mm
- ⊕ 1262 PH0x60 - PH1x80 - PH2x100 mm
- ⊕ 1262N PH1x30 mm

📦 820 g

M209	€ 83,50	📦 1	📄 024500209
MV208	€ 38,50	📦 1	📄 024510208

M213

25

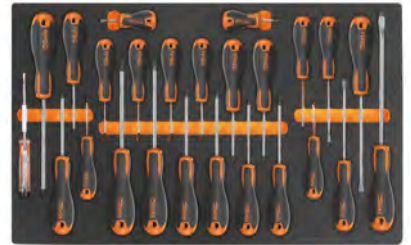

- 1201E 2,5x50-3x75-4x100-5,5x125-6,5x150-8x200 mm
- 1201EN 4x30 mm
- ⊕ 1202E PH0x60-PH1x80-PH2x100-PH3x150 mm
- ⊕ 1202EN PH1X30 mm
- ⊖ 1207E/TX T6-T7-T8-T9-T10-T15-T20-T25-T27-T30-T40-T45
- 1253 3,5x100 mm

📦 1,8 Kg

M213	€ 202,50	📦 1	📄 024500213
MV210	€ 54,50	📦 1	📄 024510210

M214

7



- 1201E 2,5x50-3x75-3,5x100-4x125-5,5x100-5,5x150-6,5x150 mm

📦 500 g

M214	€ 42,00	📦 1	📄 024500214
MV211	€ 28,50	📦 1	📄 024510211

M216

6



- ⊕ 1202E PH0x60-PH1x80-PH1x120-PH2x100-PH2x150-PH3x150 mm

📦 450 g

M216	€ 45,50	📦 1	📄 024500216
MV212	€ 28,50	📦 1	📄 024510212

Beta

Beta

M217



1207E/TX T6-T7-T8-T9-T10-T15-T20

500 g



M217	58,50	1	024500217
MV215	28,50	1	024510215

M218



1201E 3x75
4x100
5,5x150
6,5x150 mm
1202E PH0x60
PH1x80
PH2x100 mm

500 g



M218	44,00	1	024500218
MV220	28,50	1	024510220

M219



1202E 3x60 - 4,5x80 - 6x100 mm
1204E 3x75 - 4x100 - 5x150 - 6,5x150 mm

590 g



M219	44,00	1	024500219
MV220	28,50	1	024510220

M222



1272MQ PH0x60 mm
1272MQF PH1x80 - PH2x100 mm
1274MQF 3,5x100 - 4,5x100 - 5,5x125 - 6,5x150 mm

540 g



M222	121,00	1	024500222
MV222	28,50	1	024510222

M226



1274MQ 3x100
4x100
5,5x125
6,5x150 mm
1272MQ PH0x60
PH1x80
PH2x100 mm

500 g



M226	94,50	1	024500226
MV226	28,50	1	024510226

M227



944BX 6-7-8-10-13 mm

420 g



M227	119,00	1	024500227
MV227	28,50	1	024510227

M230



30 Ø 2-3-4 mm
31 Ø 2-3-4-5-6-8 mm
32 Ø 4 mm
34 150 mm
35 200-250 mm
36 125 mm
1370 500 g
1390 Ø 35 mm
1692 3 m
1712TF
1719BMA/Q 200 mm
1719BMA/T 200 mm
1719BMA/P 200 mm
1719BMA/M 200 mm
1719BMA/R 200 mm
1737NX
1771 18 mm

3,2 Kg



M230	378,00	1	024500230
MV230	54,50	1	024510230

M231



31 2-3-4-5-6-8 mm
32 4 mm
34 125-150-175 mm
36 125 mm
1370 500-1000 g
1390 Ø 35 mm
1712TF 590 mm
1715 670 mm
1719BMA8/Q 200 mm
1719BMA8/T 200 mm
1719BMA8/P 200 mm
1719BMA8/M 200 mm
1719BMA8/R 200 mm
1737NX

4,7 kg



M231	364,00	1	024500877
MV231	54,50	1	024510877

M234



35 100-200 mm
1370 300 g
1390 Ø 35 mm

1,3 kg



M234	94,50	1	024500234
MV232	28,50	1	024510232

M236



1719BMA/Q 200 mm
1719BMA/T 200 mm
1719BMA/P 200 mm
1719BMA/M 200 mm
1719BMA/R 200 mm

870 g



M236	94,00	1	024500236
MV236	28,50	1	024510236

M237



35 100-200 mm
1370T 300 mm
1390N Ø 35 mm

1,3 kg



M237	€ 103,00	1	024500237
MV232	€ 28,50	1	024510232

M240



31BM Ø 2-3-4-5-6-8 mm
32 Ø 4 mm

850 g



M240	€ 128,00	1	024500240
MV240	€ 28,50	1	024510240

M264



1491 Ø 65+110 mm
■ 1494 ■ 10 mm
○ 1494E ○ 8-9-10-11-12-14-17 mm
○ 1494Q ○ 8-9,5-12-13 mm
△ 1494T △ 9,5
○ 1494XZN ○ 16
1496C ■ 8x ■ 10 mm

2,1 kg



M264	€ 219,00	1	024500264
MV264	€ 28,50	1	024510264

M284



1128BMX
1130BMX
■ 1719BMA...Q 200 mm
▲ 1719BMA...P 200 mm
▶ 1719BMA...M 200 mm
● 1719BMA...R 200 mm
1726BM 400 mm
1728BM (5)
1771BM 170 mm
1778V18 185 mm

2,4 Kg



M284	€ 223,50	1	024500284
MV284	€ 54,50	1	024510284

M285



1112 250 mm
1128BM
1726 440 mm
1728BM (5)
1753 200 cc

1,5 kg



M285	€ 116,50	1	024500285
MV285	€ 54,50	1	024510285

M289



1692 5 m
1725CR
1755 30 cc
1771

500 g



M289	€ 47,00	1	024500289
MV289	€ 28,50	1	024510289

M292



111 250 mm
1128BMX
1692/5 5 m
1771 170 mm

500 g



M292	€ 87,50	1	024500292
MV292	€ 28,50	1	024510292

M295



1650
1682 L=300 mm
1707
1708/20

450 g



M295	€ 109,50	1	024500295
MV295	€ 28,50	1	024510295

M305



1927B
○ 720 12-13-14-15-16-17
18-19-21-22
24-27 mm
720/21

4,2 kg



M305	€ 378,00	1	024500305
MV305	€ 38,50	1	024510305

M310



1927CD
○ 720 12-13-14-15-16-17
18-19-21-22
24-27 mm
720/21

4,0 kg



M310	€ 569,00	1	024500310
MV310	€ 38,50	1	024510310

Beta

MC10

34



- 42 6-7-8-9-10-11-12
13-14-15-16-17
18-19-21-22 mm
- 96/SC9 1,5-2-2,5-3-4-5-6-8-10 mm
- ◄ 1084BM 160 mm
- ▬ 1150G 180 mm
- 1166G 160 mm
- 1201E 3,5x100-5,5x150-6,5x150 mm
- 1202E PH0x60-PH1x80-PH2x100 mm

3,5 kg



	€		
MC10	357,00	1	027500011
MCV10	38,50	1	027510010

MC12

26



- 42 6-7-8-9-10-11-12-13-14-15-16-17-18-19-21-22 mm
- 96/SC9 1,5-2-2,5-3-4-5-6-8-10 mm
- 1692/5 5 m

2,2 kg



	€		
MC12	238,00	1	041500012
MCV11	38,50	1	041510011

MC20

74



- 860MIX/A31
- 895/1
- 1048 250 mm
- 1370 300 g
- 32 Ø 4 mm
- 36 Ø 4 mm
- 900 4-4,5-5-5,5-6-7-8-9-10-11-12-13-14 mm
- 900/21 150 mm
- 900/25
- 900BG/30C
- 900/42
- 900/55
- 920A 10-11-12-13-14-15-16-17-18-19-20-21-22-23-24-26-27-30-32 mm
- 920/25
- 920AN/125 125 mm
- 920/42
- 920/55

6 kg

12"



	€		
MC20	570,00	1	027500020
MCV20	38,50	1	027510020

MC21

24



- 920A 10-11-12-13-14-15-16-17-18-19-20-21-22-23-24-26-27-30-32 mm
- 920/25
- 920/42
- ⊕ 920/55
- 920AN 125-250 mm

4,3 kg



	€		
MC21	327,00	1	041500021
MCV21	38,50	1	041510021

MB12

30



- 42 6-7-8-9-10-11-12-13-14-15-16-17-18-19-20-21-22-24-27-30-32 mm
- 55 6x7-8x9-10x11
12x13-14x15
16x17-18x19
20x22 mm
- 1048 250 mm

5,4 kg



	€		
MB12	447,00	1	024504212
MBV11	148,00	1	024524211

MB37

52



- 920A 10-11-12-13-14-15-16-17-18-19-20-21-22-23-24-26-27-30-32 mm
- 920/21 125 mm
- 920/22 150 mm
- 920/25
- 920/42
- ⊕ 920/55
- 111 250 mm
- 1052 240 mm
- ◄ 1084BM 160 mm
- ▬ 1150BM 180 mm
- 1166BM 160 mm
- 1032 180 mm
- 1034 170 mm
- 1036 175 mm
- 1038 175 mm
- 900 4,4-5-5,5-6-7-8-9-10-11-12-13-14 mm
- 900/20 50 mm
- 900/21 150 mm
- 900/25
- 900BG/30
- ⊕ 900/55
- 900/42

7,0 kg



	€		
MB37	798,00	1	024504237
MBV34	148,00	1	024524234

MB38

80



- 96T 2-2,5-3-4-5-6-7-8 mm
- 851SR 230 mm
- 860LP 0,5x3 - 0,6x4,5 - 0,8x5,5 - 1x5,5 - 1,2x6,5 mm
- 860PE 2 - 2,5 - 3 - 4 - 5 - 6 - 8 - 10 mm
- ⊕ 860PH PH0 - PH1 - PH2 - PH3 - PH4
- ⊕ 860PZ PZ1 - PZ2 - PZ3 - PZ4
- ⊕ 860RTX T9-T10-T15-T20-T25-T27-T30-T40
- ⊕ 860TX T6-T7-T8-T9-T10-T15-T20-T25-T27-T30-T40
- 860/55 100 mm
- 882P
- 892/0
- 920A 10-11-12-13-14-15-16-17-18-19-20-21-22-23-24-26-27-30-32 mm
- 920/21 125 mm
- 920/22 255 mm
- 920/25
- 920/42
- ⊕ 920/55
- ◄ 1084BM 160 mm
- ▬ 1150BM 180 mm
- 1166BM 160 mm

5,9 kg



	€		
MB38	735,00	1	024504238
MBV35	148,00	1	024524235

MB39

39



- 920A 10-11-12-13-14-15-16-17-18-19-20-21-22-23-24-26-27-30-32 mm
- 920/21 125 mm
- 920/22 255 mm
- 920/25
- 920/42
- ⊕ 920/55
- 920PE 5-6-8-10-12 mm
- 1032 180 mm
- 1034 170 mm
- 1036 175 mm
- 1038 175 mm
- 35 200 mm
- ◄ 1084BM 160 mm
- ▬ 1150BM 180 mm
- 1166BM 160 mm
- 1370 500 g
- 1390 35 mm

7,2 kg



	€		
MB39	715,00	1	024504239
MBV36	148,00	1	024524236

MB44

34



- 1260 2,5x50-3x75-3,5x100-4x100-5,5x125-6,5x150-8x200 mm
- 1260N 4x30-6,5x30 mm
- ⊕ 1262 PH0x60-PH0x100-PH1x80-PH1x120-PH2x100-PH2x150-PH3x150 mm
- ⊕ 1262N PH1x30-PH2x30 mm
- 1253
- 96BPC/SC9
- 951 2,5-3-4-5-6-8 mm

2,8 kg



	€	
MB44	359,00	1 024504244
MBV44	148,00	1 024524244

MB45

29



- 1260 2,5x50-3x75-3,5x100-4x100-5,5x100-5x125-6,5x150 mm
- ⊕ 1262 PH0x60-PH0x100-PH1x80-PH1x120-PH2x100-PH2x150 mm
- ⊖ 1267TX T8-T10-T15-T20-T25-T30
- 1052 240 mm
- 96BPC/SC9

2,8 kg



	€	
MB45	267,00	1 024504245
MBV45	148,00	1 024524245

MB46

29



- 1260 3x75-4x100-5,5x125-6,5x150 mm
- ⊕ 1262 PH0x60-PH1x80-PH2x100 mm
- ⊖ 1267TX T8-T10-T15-T20-T25-T30
- 96BPC/SC9
- 96T 2-2,5-3-4-5-6
- 1052 240 mm

2,8 kg



	€	
MB46	298,00	1 024504246
MBV46	148,00	1 024524246

MB47

48



- 1260 3x75-4x100-5,5x125-6,5x150 mm
- ⊕ 1262 PH0x60-PH1x80-PH2x100 mm
- 1260N 4x30 mm
- ⊕ 1262N PH1x30 mm
- 96T 2,5-3-4-5-6-8 mm
- 96BPC/SC9
- 920A 10-11-12-13-14-15-16-17-18-19-20-21-22-23-24-26-27-30-32 mm
- 920/21 125 mm
- 920/22 250 mm
- 920/25
- 920/42
- ⊖ 920/55

5,6 kg

12"



	€	
MB47	586,00	1 024504247
MBV47	148,00	1 024524247

MB56

15

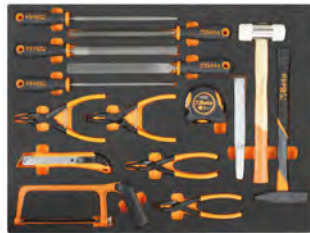

- 1719BMA/Q 200 mm
- ▲ 1719BMA/T 200 mm
- 1719BMA/P 200 mm
- ▶ 1719BMA/M 200 mm
- 1719BMA/R 200 mm
- 1032 180 mm
- 1034 170 mm
- 1036 175 mm
- 1038 175 mm
- 1370T 300 g
- 1390N Ø 35 mm
- 35 200 mm
- 1692 5 mt
- 1725CR 260 mm
- 1771 18 mm

3,7 kg



	€	
MB56	343,00	1 024504256
MBV56	148,00	1 024524256

Beta

Quality Tools

MB58

17



- 31 Ø 2-3-4-5-6 mm
- 32 Ø 4 mm
- 35 200 mm
- 1112 250 mm
- 1128BMX
- 1370 500 g
- 1390 Ø 45 mm
- 1719BMA...Q 200 mm
- ▲ 1719BMA...T 200 mm
- 1719BMA...P 200 mm
- ▶ 1719BMA...M 200 mm
- 1719BMA...R 200 mm
- 1726 440 mm

4,5 kg



	€	
MB58	343,00	1 024504258
MBV55	148,00	1 024524255

MB59

15



- 1719BMA...Q 200 mm
- ▲ 1719BMA...T 200 mm
- 1719BMA...P 200 mm
- ▶ 1719BMA...M 200 mm
- 1719BMA...R 200 mm
- 31 Ø 4-6 mm
- 32 Ø 4 mm
- 35 125-200 mm
- 1370 300 g
- 1390 Ø 35 mm
- 1692 5 mt
- 1725 420 mm
- 1833XS/2

3,4 kg



	€	
MB59	287,00	1 024504259
MBV57	148,00	1 024524257

Beta

Quality Tools

MB65

16

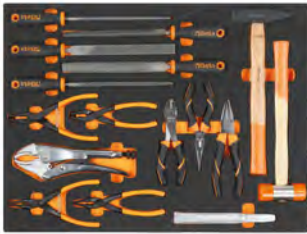

1719BMA...Q	200 mm
1719BMA...P	200 mm
1719BMA...T	200 mm
1719BMA...M	200 mm
1719BMA...R	200 mm
35	200 mm
1032	180 mm
1034	170 mm
1036	175 mm
1038	175 mm
1052	240 mm
1084BM	160 mm
1150BM	180 mm
1166BM	160 mm
1370	500 g
1390	Ø 35 mm

4,8 kg

MB65	440,00	1	024504265
MBV61	148,00	1	024524261

MB63

60

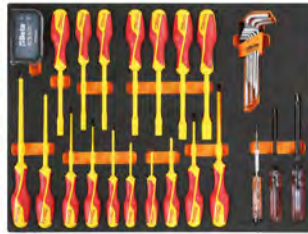

96BPC/SC9	
1250	4x125 mm
1251	PH1x150 mm
1253	
943MQ	5,5-6-7-8-10-13 mm
1272MQ	PH0x60-PH1x80-PH2x100-PH3x150 mm
1274MQ	2,5x75-3x100-4x100-5,5x125-6,5x150-8x175 mm
860LP	0,5x3 - 0,6x4 - 0,8x5,5 1,0x5,5 - 1,2x6,5 mm
860PE	2 - 2,5 - 3 - 4 - 5 - 6 8 - 10 mm
860PH	PH0 - PH1 - PH2 - PH3 - PH4
860PZ	PZ1 - PZ2 - PZ3 - PZ4
860RTX	T9 - T10 - T15 - T20 T25 - T27 - T30 - T40
882MSR/50	Ø 1/4 ● 1/4
850MQ	

3,2 kg

MB63	456,00	1	024504263
MBV63	148,00	1	024524263

MB64

20



55	6x7-8x9-10x11 12x13-14x15 16x17-18x19 20x22 mm
1048MQ	250 mm
1082MQ	140 mm
1128BSX	
1132MQ	230 mm
1142MQ	160 mm
1150MQ	180 mm
1166MQ	160 mm
1168MQ	160 mm
110MQ	250 mm
1777MQ	
993MQ	
1602	

4,1 kg

MB64	762,00	1	024504264
MBV62	148,00	1	024524262

MM11

30



42	6-7-8-9-10-11-12-13-14-15-16-17-18-19- 20-21-22-24-27-30-32 mm
96BPC/SC9	1,5-2-2,5-3-4-5-6-8-10 mm

4,5 kg

MM11	374,00	1	024580011
MMV10	54,50	1	024590010

MM61

17



96T	2-2,5-3-4-5-6-7-8 mm
1390	Ø 35
1370	300 g
35	100-200 mm
1719BMA8/S5	200 mm

2,9 kg

MM61	298,00	1	024580061
MMV61	54,50	1	024590061

 **Beta**

 **Beta**

Beta

MM105

107



- 895/1 □1/4-□1/4
- 895/3 □1/4-□3/8
- 895/6 □5/16-□1/2
- 900 4-4-5-5-5-5-6-7-8-9-10-11-12-13-14 mm
- 900L 5-6-7-8-9-10-11-12-13 mm
- 900ME 3-4-5-6-7 mm
- 900LP 0,8x4-1x5,5-1,2x6,5-1,2x8
- 900PH PH1-PH2-PH3-PH4
- 900TX T10-T15-T20-T25-T27-T30-T40
- 900/16 50-100-150 mm
- 900/... 50-100-150 mm
- 900/25 176 mm
- 900BG/30 176 mm
- 900/42 115 mm
- 900/55 125 mm
- 910A 6-7-8-9-10-11-12-13-14-15-16-17-18-19-20-21-22 mm
- 910/15 □3/8-■1/4
- 910/16 □3/8-■1/2
- 910/21 125 mm
- 910/22 250 mm
- 910/25 210 mm
- 910/42 210 mm
- 910/55 200 mm
- 920A 8-10-11-12-13-14-15-16-17-18-19-20-21-22-23-24-26-27-28-30-32 mm
- 920/15 □1/2-■3/8
- 920/25 125-250 mm
- 920/42 305 mm
- 920/55 275 mm
- 956E 16 mm (5/8")-17,8 (11/16")-20,8 (13/16")

7,2 kg

MM105	1.177,00	1	024580105
MMV105	54,50	1	024590105

MM140

52



- 97TTX T10-T15-T20-T25-T30
- 1084BM 160 mm
- 1150BM 180 mm
- 1166BM 160 mm
- 1032 180 mm
- 1034 170 mm
- 1036 175 mm
- 1038 175 mm
- 1048 250 mm
- 1052 240 mm
- 1256/C36-2

2,2 kg

MM140	439,00	1	024580141
MMV140	54,50	1	024590140

MM210

25



- 1201E 2,5x50-3x75-4x100-5,5x125-6,5x150-8x200 mm
- 1201EN 4x30 mm
- 1202E PH0x60-PH1x80-PH2x100-PH3x150 mm
- 1202EN PH1X30 mm
- 1207E/TX T6-T7-T8-T9-T10-T15-T20-T25-T27-T30-T40-T45
- 1253

2,1 kg

MM210	202,50	1	024580211
MMV210	54,50	1	024590210

Beta

VPM0

soft thermoformed tray with tote tray



VPM0	22,20	1	088870350
------	-------	---	-----------

VPM3

soft thermoformed tray with 4 tote trays

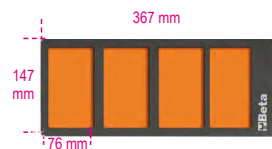

VPM3	22,20	1	088870353
------	-------	---	-----------

VPM7

soft thermoformed tray with 3 tote trays

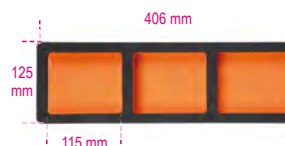

VPM7	23,90	1	088870356
------	-------	---	-----------

VPM8

soft thermoformed tray with tote tray



VPM8	18,20	1	088870357
------	-------	---	-----------

VPM9

soft thermoformed tray with tote tray



VPM9	17,60	1	088870358
------	-------	---	-----------

VPM7-C

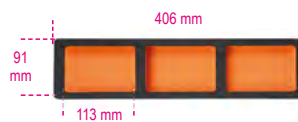

VPM7-C	27,50	1	088870360
--------	-------	---	-----------

Hard thermoformed trays T-series



Assortment of tools in thermoformed trays, designed for all roller cabs and all trolleys.

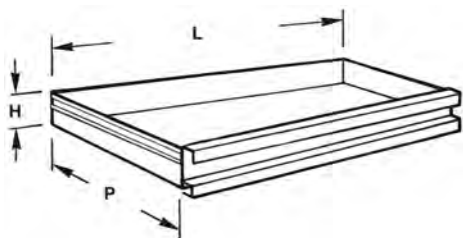

H mm	LxP mm
70	588x367

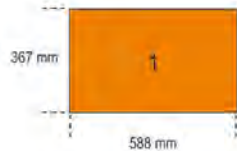
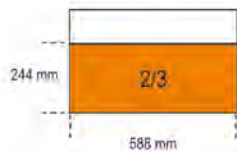
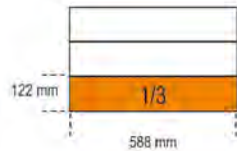
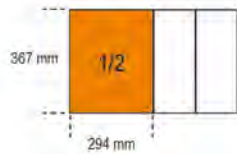
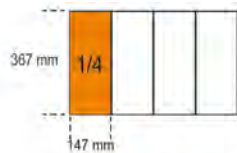

T01



42 6-7-8-10-11-12-13
14-16-17-18-19-21
22-24-27-30 mm



2,7 kg



	€	1	024240001
T01	244,50	1	024240001
TV10	28,00	1	024000400

T05



42 6-7-8-9-10-11-12
13-14-15-16-17
18-19-20-21 mm



1,5 kg



	€	1	024240005
T05	188,00	1	024240005
TV15	21,00	1	024000445

T06



42 22-24-27-30-32 mm



2,1 kg



	€	1	024240006
T06	133,50	1	024240006
TV16	21,00	1	024000446

T13



42SLIM 8-10-11-12
13-14-15-16-17
18-19 mm



1,5 kg



	€	1	024240013
T13	136,50	1	024240013
TV13	21,00	1	024249913

T18



42MP 6-7-8-9-10-11-12
13-14-15-16-17
18-19-20-21 mm



1,5 kg



	€	1	024240018
T18	269,00	1	024240018
TV15	21,00	1	024000445

T19



42MP 22-24-27-30-32 mm



2,1 kg



	€	1	024240019
T19	179,00	1	024240019
TV16	21,00	1	024000446

T22



42AS 5/16-3/8-7/16-1/2
9/16-5/8-11/16-3/4
96AS/IG7 3/32-1/8-5/32-3/16
1/4-5/16-3/8



1 kg



	€	1	024240022
T22	144,50	1	024240022
TV20	21,00	1	024000488

T23



42INOX 8-10-11-12-13-14-15-
17-19 mm
96BPINOX 2,5-3-4-5-6-8-10 mm



1 kg



	€	1	024240023
T23	246,00	1	024240023
TV23	21,00	1	024249906

T31

31 Ø 2-3-4-5-6 mm
 32 Ø 4 mm
 55 6x7-8x9-10x11
 12x13-14x15
 16x17-18x19
 20x22-21x23
 24x26-27x29
 30x32 mm
 ○ 96N/SC9 1,5+10 mm

📦 3 kg



T31	€ 203,00	📦 1	📄 024240031
TV30	€ 28,00	📦 1	📄 024000401

T33

55 6x7-8x9-10x11
 12x13-14x15
 16x17-18x19
 20x22 mm
 ○ 96/SC9 1,5+10 mm

📦 1 kg



T33	€ 86,00	📦 1	📄 024240033
TV20	€ 21,00	📦 1	📄 024000488

T34

55MP 6x7-8x9-10x11
 12x13-14x15
 16x17-18x19
 20x22 mm
 ○ 96/SC9 1,5+10 mm

📦 1 kg



T34	€ 109,50	📦 1	📄 024240034
TV20	€ 21,00	📦 1	📄 024000488

T40

90 6x7-8x9-10x11
 12x13-14x15
 16x17-18x19 mm

📦 810 g



T40	€ 96,50	📦 1	📄 024240040
TV40	€ 21,00	📦 1	📄 024000456

T41

90 20x22-21x23
 24x26-25x28
 27x29 mm

📦 1,5 kg



T41	€ 141,50	📦 1	📄 024240041
TV41	€ 21,00	📦 1	📄 024000457

T45

142 8-9-10-11-12
 13-14-15-16
 17-18-19 mm

📦 1,3 kg



T45	€ 289,00	📦 1	📄 024240045
TV45	€ 21,00	📦 1	📄 024000498

T46

142SN 8-9-10-11-12
 13-14-15-16
 17-18-19 mm

📦 1,5 kg



T46	€ 344,00	📦 1	📄 024240046
TV46	€ 21,00	📦 1	📄 024000499

T48

○ 96BPC/SC9 1,5+10 mm
 142C 8-9-10-11-12
 13-14-15-16
 17-18-19 mm

📦 1,4 kg



T48	€ 247,50	📦 1	📄 024240048
TV47	€ 21,00	📦 1	📄 024000763

T50

○ 96T 2-2,5-3-3,5-4-4,5
 5-6-7-8-10 mm

📦 1,3 kg



T50	€ 162,00	📦 1	📄 024240050
TV50	€ 28,00	📦 1	📄 024000764

T52

○ 96T 2-2,5-3-4-5-6 mm

📦 350 g



T52	€ 78,50	📦 1	📄 024240052
TV52	€ 21,00	📦 1	📄 024000765

T53

○ 96TBP 2,5-3-4-5-6 mm

📦 300 g



T53	€ 70,50	📦 1	📄 024240053
TV52	€ 21,00	📦 1	📄 024000765

T55

○ 97TTX T10-T15-T20
 T25-T27-T30

📦 330 g



T55	€ 91,00	📦 1	📄 024240055
TV55	€ 21,00	📦 1	📄 024000766

T56



○ 96BP 2-3-4-5-6-8-10 mm
 ○ 97TX T20-T25-T30-T40-T45-T50-T55



300 g



T56	€ 108,50	1	024240056
TV56	€ 21,00	1	024249901

T57



○ 96TINOX 2,5-3-4-5-6 mm



350 g



T57	€ 75,00	1	024240057
TV57	€ 21,00	1	024249907

T59



111 250 mm
 920/40 1/2
 ○ 951 2,5-3-4-5-6-8 mm
 ○ 953 4-5-6-8 mm
 1370 300 - 500 g

4,7 kg



T59	€ 407,00	1	024240059
TV60	€ 42,00	1	024000420

T63



○ 952 7-8-10-12-13-14-17-19 mm



3,8 kg



T63	€ 308,00	1	024240063
TV63	€ 35,00	1	024000471

T64



○ 952FTX E10-E12-E14
 ○ 953TX T25-T27-T30-T40-T45



3,8 kg



T64	€ 377,00	1	024240064
TV63	€ 35,00	1	024000471

T65



○ 953 3-3,5-4-5-6-7-8-10 mm



2,8 kg



T65	€ 297,00	1	024240065
TV63	€ 35,00	1	024000471

T68



○ 951 2,5-3-4-5-6-8 mm



590 g



T68	€ 133,00	1	024240068
TV68	€ 21,00	1	024000470

T73



○ 930 6x7-8x9-10x11-12x13-14x15-16x17-18x19-20x22 mm



1,3 kg



T73	€ 195,00	1	024240073
TV73	€ 21,00	1	024000418

T75



○ 933 7-8-9-10-11-12-13-14-15-16-17-18-19-21-22-24 mm



4,2 kg



T75	€ 400,00	1	024240075
TV75	€ 42,00	1	024000422

T76



○ 932 7-8-9-10-11-12-13-14-15-16-17-18-19-21-22-24 mm



4,2 kg



T76	€ 400,00	1	024240076
TV75	€ 42,00	1	024000422

T77



○ 933 6-7-8-10-11-12-13-14-17-19 mm



1,4 kg



T77	€ 199,50	1	024240077
TV77	€ 21,00	1	024000474

T79



80 8x9-10x11-12x13-14x15-16x17-18x19 mm



1,3 kg



T79	€ 267,00	1	024240079
TV79	€ 21,00	1	024000490

T80



- 920A 10-11-12-13-14
15-16-17-18-19
20-21-22-23-24
26-27-30-32 mm
- 920ME 5-6-8-10-12 mm
- 920/21 125 mm
- 920/22 255 mm
- 920/25 305 mm
- Ⓢ 920/55

4,1 kg

12"



T80	385,00	1	024240080
TV80	28,00	1	024000403

T81



- 920B 10-11-12-13-14
15-16-17-18-19
20-21-22-23-24
26-27-30-32 mm
- 920ME 5-6-8-10-12 mm
- 920/21 125 mm
- 920/22 255 mm
- 920/25 305 mm
- Ⓢ 920/55

4,1 kg

12"



T81	385,00	1	024240081
TV80	28,00	1	024000403

T82



- 920A 10-11-12-13-14
15-16-17-18-19
20-21-22-23-24
26-27-30-32 mm
- 920ME 5-6-8-10-12 mm
- 920AN/125 125 mm
- 920AN/250 250 mm
- 920/25 305 mm
- Ⓢ 920/55

4,1 kg

12"



T82	397,00	1	024240082
TV80	28,00	1	024000403

T83



- 920A 10-11-12-13-14
15-16-17-18-19
20-21-22-23-24
26-27-30-32 mm
- 920/21 125 mm
- 920/22 255 mm
- 920/25 305 mm
- Ⓢ 920/55

3,6 kg

12"



T83	300,00	1	024240083
TV83	28,00	1	024000402

T85



- 861LP 0,5x3 - 0,6x4,5 - 0,8x5,5 - 1x5,5 - 1,2x6,5 - 1,2x8 - 1,6x8 mm
- 861PE 2 - 2,5 - 3 - 4 - 5 - 6 - 8 - 10 mm
- ⊕ 861PH PH0 - PH1 - PH2 - PH3
- ⊕ 861PZ PZ1 - PZ2 - PZ3
- ⊕ 861TX T6-T7-T8-T9-T10-T15-T20-T25-T27-T30-T40
- ⊕ 861RTX T9-T10-T15-T20-T25-T27-T30-T40
- ⊕ 861TRW 1-2-3-4-5-6 mm
- ⊕ 861TQS 0-1-2-3-4-5-6-8-10 mm
- ⊕ 861SP 4-6-8-10-12 mm
- 851SR 230 mm
- 900 4-4,5-5-5,5-6-7-8-9
10-11-12-13-14 mm
- 900/21 150 mm
- 900/25 41 mm
- 900BG/30 176 mm
- 900/42 115 mm
- Ⓢ 900/55 125 mm
- 194 1/4x5/16

1,0 kg

14"



T85	321,00	1	024240085
TV85	28,00	1	024000747

T91



- 900 4-4,5-5-5,5-6
7-8-9-10-11
12-13-14 mm
- 900ME 2,5-3-4-5-6-8 mm
- 900/20 50 mm
- 900/21 150 mm
- 900/25 115 mm
- 900BG/30 115 mm
- Ⓢ 900/55

560 g

14"



T91	209,50	1	024240091
TV90	21,00	1	024000447

T92



- 910A 6-7-8-9-10-11-12-13
14-15-16-17-18-19
20-21-22 mm
- 910/21 125 mm
- 910/22 250 mm
- 910/25 210 mm
- 910/42 210 mm
- Ⓢ 910/55

1,5 kg

38"



T92	236,50	1	024240092
TV92	21,00	1	024000458

T99



- 920INOX-A 10-12-13-14-15-16-17
18-19-21-22-24-27
30-32 mm
- Ⓢ 920/55INOX



2,7 kg

12"



T99	1.067,00	1	024240099
TV99	21,00	1	024249908

T100



- 920A 10-12-13-14-15
16-17-18-19-21
22-24 mm
- 920/21 125 mm
- 920/25 305 mm
- Ⓢ 920/55

2,1 kg

12"



T100	215,00	1	024240100
TV100	21,00	1	024000495

T101



- 920B 10-12-13-14-15
16-17-18-19-21
22-24 mm
- 920/21 125 mm
- 920/25 305 mm
- Ⓢ 920/55

2,1 kg

12"



T101	215,00	1	024240101
TV100	21,00	1	024000495

T102



- 920AS 3/8-7/16-1/2
9/16-5/8-11/16
3/4-13/16-7/8
15/16-1-1-1/16
- 920/21 125 mm
- 920/25 305 mm
- Ⓢ 920/55

2,1 kg

12"



T102	234,50	1	024240102
TV100	21,00	1	024000495

T103



- 900L 6-7-8-9-10-11-12 mm
- 920AL 13-14-16-17-18-19
21-22-24-27 mm

1,1 kg

14" 12"



T103	€ 281,00	1	024240103
TV103	€ 21,00	1	024000748

T105



- 928A 22-24-27-30-32-34
36-38-41-46-50 mm

4,9 kg

34"



T105	€ 279,00	1	024240105
TV105	€ 21,00	1	024000484

T106



- 928/21 200 mm
- 928/22 380 mm
- 928/42 450 mm
- 928/55

4,5 kg

34"



T106	€ 295,00	1	024240106
TV106	€ 21,00	1	024000485

T110



- 720 10-11-12-13-14
16-17-18-19-21
22-23-24 mm
- 720/21 125 mm

1,8 kg

12"



T110	€ 184,00	1	024240110
TV110	€ 21,00	1	024000477

T112



- 861TX ● 1/4-T6+T15
- 866TX ● 5/16-T20+T55
- 895/1 ○ 1/4x□1/4
- 895/6 ○ 5/16x□1/2
- 900FTX □ 1/4-E4+E10
- 920FTX □ 1/2-E12+E24
- 920TX □ 1/2-T55L-T60-T70L

1,3 kg

14" 12"



T112	€ 281,00	1	024240112
TV112	€ 21,00	1	024000480

T113



- 920PE 5L-6L-7L-8L-10L
- 920TX T40L-T45L
T55L-T70L
- 920XZN M6L-M8L-M12L

1,5 kg

12"



T113	€ 250,00	1	024240113
TV113	€ 21,00	1	024000489

T121



- 666N/20 40 - 200 Nm

1,4 kg

12"



T121	€ 267,00	1	024240121
TV121	€ 21,00	1	024000767

T123



- 1082G 160 mm
- 1150G 180 mm
- 1166G 160 mm

550 g

€ 72,00

1 024240123

T123	€ 72,00	1	024240123
TV135	€ 21,00	1	024000762

T124



- 1082GBM 160 mm
- 1150GBM 180 mm
- 1166GBM 160 mm

640 g

€ 91,50

1 024240124

T124	€ 91,50	1	024240124
TV135	€ 21,00	1	024000762

T135



- 1082MQ 160 mm
- 1150MQ 180 mm
- 1166MQ 160 mm

△ 1000 V

750 g

€ 154,00

1 024240135

T135	€ 154,00	1	024240135
TV135	€ 21,00	1	024000762

T136



- 1048MQ 250 mm
- 1777MQ/U

△ 1000 V

700 g

€ 110,00

1 024240136

T136	€ 110,00	1	024240136
TV136	€ 21,00	1	024000438

T137



- 1084BM 160 mm
- 1150BM 180 mm
- 1166BM 160 mm

750 g

€ 104,50

1 024240137

T137	€ 104,50	1	024240137
TV130	€ 21,00	1	024000451

T138



- ◄ 1084 160 mm
- ≡ 1150 180 mm
- 1166 160 mm

📦 650 g

T138	€ 85,50	1	024240138
TV130	€ 21,00	1	024000451

T146



- 1032 140x0,9 mm
- 1032 225 mm
- 1036 140x1,3 mm
- 1036 225 mm

📦 700 g

T146	€ 121,50	1	024240146
TV146	€ 21,00	1	024000449

T157



- ◄ 1082BM 160 mm
- ≡ 1150BM 180 mm
- 1048BM 250 mm

📦 1,1 kg

T157	€ 117,50	1	024240157
TV148	€ 21,00	1	024000500

T140



- 1032 140x0,9 - 180 mm
- 1034 170 mm
- 1036 140x1,3 - 175 mm
- 1038 175 mm
- ◄ 1084 160 mm
- 1128BM

📦 1,1 kg

T140	€ 212,50	1	024240140
TV140	€ 28,00	1	024000405

T151



- 1047 240 mm
- 1057A 240 mm

📦 1,3 kg

T151	€ 108,00	1	024240151
TV150	€ 21,00	1	024000462

T160



Betamax
HIGH TORQUE PH SCREWDRIVERS

- 1290 3x75
- 3x100
- 4x100
- 4x150
- 5,5x100
- 5,5x150
- 6,5x150
- 8x150
- 10x200 mm
- 1290N 4x30
- 6,5x30 mm

📦 1,3 kg

T160	€ 122,50	1	024240160
TV160	€ 28,00	1	024000706

T144



- 1048 250 mm
- 1052 240 mm
- 1112 250 mm
- ≡ 1150 180 mm

📦 1,8 kg

T144	€ 128,50	1	024240144
TV143	€ 28,00	1	024000409

T153



- 1048 250 mm
- 1052 240 mm

📦 1,1 kg

T153	€ 71,50	1	024240153
TV150	€ 21,00	1	024000462

T161



Betamax
HIGH TORQUE PH SCREWDRIVERS

- 1292 PH0x60
- PH0x100
- PH1x80
- PH1x120
- PH2x100
- PH2x150
- PH3x150 mm
- 1292N PH1x30
- PH2x30 mm

📦 1 kg

T161	€ 96,50	1	024240161
TV161	€ 28,00	1	024000707

T145



- 1032 180 mm
- 1034 170 mm
- 1036 175 mm
- 1038 175 mm

📦 640 g

T145	€ 116,00	1	024240145
TV145	€ 21,00	1	024000448

T156



- ◄ 1082 160 mm
- ≡ 1150 180 mm
- 1048 250 mm

📦 1 kg

T156	€ 92,00	1	024240156
TV148	€ 21,00	1	024000500

T164



- 952 8-10-13-17-19 mm
- 959 16 mm (5/8") - 20,8 mm (13/16")
- 1260 3x75-4x100-5,5x100-6,5x150-10x200 mm
- 1262 PH0x60-PH1x80-PH2x100-PH3x150 mm

📦 5 kg

T164	€ 429,00	1	024240164
TV61	€ 42,00	1	024000721

T167



- 1260 3x75
3x100
4x100
4x150
5,5x100
5,5x150
6,5x150
8x150
10x200 mm
- 1260N 4x30
6,5x30 mm

1,3 kg



T167	€ 102,00	1	024240167
TV160	€ 28,00	1	024000706

T168



- ⊕ 1262 PH0x60
PH0x100
PH1x80
PH1x120
PH2x100
PH2x150
PH3x150 mm
- ⊕ 1262N PH1x30
PH2x30 mm

1 kg



T168	€ 81,00	1	024240168
TV161	€ 28,00	1	024000707

T170



- 1290 2,5x50
3x75
3,5x100
4x125
5,5x100
5,5x150
6,5x150 mm

450 g



T170	€ 66,50	1	024240170
TV170	€ 21,00	1	024000741

T171



- 1290 8x150
8x200
10x200 mm
- 1290N 4x30
6,5x30 mm

750 g



T171	€ 73,50	1	024240171
TV171	€ 21,00	1	024000742

T172



- ⊕ 1292 PH0x60
PH0x100
PH1x80
PH1x120
PH2x100
PH2x150 mm

450 g



T172	€ 60,50	1	024240172
TV172	€ 21,00	1	024000743

T173



- ⊕ 1292 PH3x150
PH4x200 mm
- ⊕ 1292N PH1x30
PH2x30 mm

560 g



T173	€ 59,50	1	024240173
TV173	€ 21,00	1	024000744

T175



- ⊖ 1297TX T6-T7-T8-T9
T10-T15-T20

410 g



T175	€ 95,50	1	024240175
TV175	€ 21,00	1	024000760

T176



- ⊖ 1297TX T25-T27-T30
T40-T45

640 g



T176	€ 87,50	1	024240176
TV176	€ 21,00	1	024000761

T177



- ⊕ 1298RTX T9-T10-T15
T20-T25-T27
T30-T40

680 g



T177	€ 133,50	1	024240177
TV177	€ 21,00	1	024000759

T180



- 1290 3x75
4x100
5,5x150
6,5x150 mm
- ⊕ 1292 PH0x60
PH1x80
PH2x100 mm

480 g



T180	€ 69,00	1	024240180
TV180	€ 21,00	1	024000701

T183



- ⊕ 1292L PH1x400-PH2x400 mm
- 1294L 3x300-4x400-5x400 mm

580 g



T183	€ 95,00	1	024240183
TV183	€ 21,00	1	024000497

T198



- 1260 3x75
4x100
5,5x150
6,5x150 mm
- ⊕ 1269PZ PZ0 - PZ1 - PZ2

490 g



T198	€ 60,50	1	024240198
TV180	€ 21,00	1	024000701

T199



- 1260 2,5x50
3x75
3,5x100
4x125
5,5x100
5,5x150
6,5x150 mm

490 g



T199	€ 54,50	1	024240199
TV170	€ 21,00	1	024000741

T201



- 1260 8x200
10x150
10x200 mm
- 1260N 4x30
6,5x30 mm

680 g



T201	€ 59,50	1	024240201
TV171	€ 21,00	1	024000742

T202



- ⊕ 1262 PH0x60
PH0x100
PH1x80
PH1x120
PH2x100
PH2x150 mm

490 g



T202	€ 50,00	1	024240202
TV172	€ 21,00	1	024000743

T204



- ⊕ 1262 PH3x150
PH4x200 mm
- ⊕ 1262N PH1x30
PH2x30 mm

610 g



T204	€ 49,50	1	024240204
TV173	€ 21,00	1	024000744

T205



- ⊕ 1267TX T6-T7-T8-T9
T10-T15-T20

460 g



T205	€ 71,50	1	024240205
TV175	€ 21,00	1	024000760

T206



- ⊕ 1267TX T25-T27-T30
T40-T45

710 g



T206	€ 73,50	1	024240206
TV176	€ 21,00	1	024000761

T207



- ⊕ 1268RTX T9-T10-T15
T20-T25-T27-T30

760 g



T207	€ 88,00	1	024240207
TV207	€ 21,00	1	024000758

T208



- 1260 3x75
4x100
5,5x150
6,5x150 mm
- ⊕ 1262 PH0x60
PH1x80
PH2x100 mm

530 g



T208	€ 57,50	1	024240208
TV180	€ 21,00	1	024000701

T209



- ⊕ 1262L PH1x400-PH2x400 mm
- 1264L 3x300-4x400-5x400 mm

580 g



T209	€ 72,00	1	024240209
TV183	€ 21,00	1	024000497

T211



- 1201E 2,5x50
3x75
3,5x100
4x125
5,5x100
5,5x150
6,5x150 mm

490 g



T211	€ 39,50	1	024240211
TV170	€ 21,00	1	024000741

T213



- ⊕ 1202E PH0x60
PH1x80
PH1x120
PH2x100
PH2x150
PH3x150 mm

490 g



T213	€ 43,00	1	024240213
TV212	€ 21,00	1	024000440

T216



- ⊕ 1207E/TX T6-T7-T8-T9
T10-T15-T20

410 g



T216	€ 55,00	1	024240216
TV175	€ 21,00	1	024000760

T221



- 1201E 3x75
4x100
5,5x150
6,5x150 mm
- ⊕ 1202E PH0x60
PH1x80
PH2x100 mm

530 g



T221	€ 42,00	1	024240221
TV180	€ 21,00	1	024000701

T226

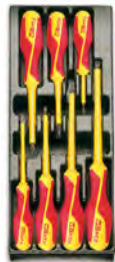

- 1274MQ 3x100
4x100
5,5x125
6,5x150 mm
- ⊕ 1272MQ PH0x60
PH1x80
PH2x100 mm

1000 V

460 g



T226	€ 89,00	1	024240226
TV180	€ 21,00	1	024000701

T227



- 944BX 5-6-7-8-10-13 mm

490 g



T227	€ 128,00	1	024240227
TV227	€ 21,00	1	024000705

T228



- 1290INOX 3x75 - 4x100 -
5,5x150 - 6,5x150 mm
- ⊕ 1292INOX PH0x60 - PH1x80 -
PH2x100 mm



480 g



T228	€ 79,50	1	024240228
TV180	€ 21,00	1	024000701

T231



- 1370 400 g
- 1390 Ø 35 mm
- ▲ 1719BMA/T 200 mm
- 1719BMA/P 200 mm
- ▷ 1719BMA/M 200 mm

1,7 kg



T231	€ 109,00	1	024240231
TV230	€ 28,00	1	024000411

T233



- 35 100-200 mm
- 1370F 32 mm
- 1390 Ø 35 mm

1,3 kg



T233	€ 100,50	1	024240233
TV232	€ 21,00	1	024000452

T234



- 35 100-200 mm
- 1370 300 g
- 1390 Ø 35 mm

1,3 kg



T234	€ 89,50	1	024240234
TV232	€ 21,00	1	024000452

T236



- 1719BMA/Q 200 mm
- ▲ 1719BMA/T 200 mm
- 1719BMA/P 200 mm
- ▷ 1719BMA/M 200 mm
- 1719BMA/R 200 mm

670 g



T236	€ 89,00	1	024240236
TV235	€ 21,00	1	024000453

T239



- 31BM Ø 2-3-4-5-6-8 mm
- 32 Ø 4 mm

850 g



T239	€ 119,50	1	024240239
TV239	€ 21,00	1	024000439

T241



- 1500N/1
- 1500N/3
- 1516/1

4,2 kg



T241	€ 275,00	1	024240241
TV241	€ 28,00	1	024000414

T250

Automotive



- 34 150 mm
- 83/S3 11x13-14x17
19x22 mm
- 1458 175 mm
- 1491
- 1603
- 1708/13 0,05+1 mm

1430 g



T250	€ 241,50	1	024240250
TV250	€ 28,00	1	024000408

T256

Automotive



- 956E 16 mm (5/8) - 20,8 mm (13/16)
- 956L 16 mm (5/8) - 20,8 mm (13/16)
- 959 16 mm (5/8) - 20,8 mm (13/16)
- 1164 200 mm
- 1708/20 0,05+1 mm

3,2 kg



T256	€ 383,00	1	024240256
TV255	€ 35,00	1	024000467

T259



- 96BP 2,5-3-4-5
6-8-10 mm
- 96N 12 mm
- 860MIX/A31
-
- +
- +
- +
- 895/1

950 g



T259	139,00	1	024240259
TV263	21,00	1	024000492

T264



- 1491 Ø 65÷110 mm
- 1494 ■ 10 mm
- 1494E ○ 8-9-10-11-12-14-17 mm
- 1494Q ○ 8-9,5-12-13 mm
- △ 1494T △ 9,5
- 1494XZN ○ 16
- 1496C ■ 8x ■ 10 mm

2,1 kg



T264	206,50	1	024240264
TV264	21,00	1	024000466

T270



- 430 M3 - 4 - 5 - 6 - 7 - 8 - 9
10 - 12 - 14 - 16 - 18 - 20
- 433 M6x0,75 - M8x1 - M10x1,25
M12x1,5 - M14x1,5
M16x1,5 - M18x1,5
- 440 M3 - 4 - 5 - 6 - 7 - 8 - 9
- 440A M10 - 12 - 14 - 16 - 18 - 20
- 441 M6x0,75 - M8x1,0
- 441A M10x1,25 - M12x1,5
M14x1,5 - M16x1,5
M18x1,5

4,3 kg



T270	482,00	1	024240270
TV270	28,00	1	024000481

T273



- 435/1,5 M3÷M12
- 435/3 M5÷M21
- 436/1 □ 2,0÷5,0 mm
(M3÷M8)
- 436/2 □ 4,6÷8 mm
(M5÷M12)
- 444/1 Ø 25,4 mm
- 444/2 Ø 38,1 mm
- 1707 W 62÷4x1"

2,1 kg



T273	219,50	1	024240273
TV272	28,00	1	024000482

T281



- 1741B 250 mm
- 1741RV2,9K 2,9x6 mm (100)
- 1741RV3,2K 3,2x8 mm (100)
- 1741RV3,8K 3,8x10 mm (100)
- 1741RV4K 4x12 mm (100)

1,4 kg



T281	66,00	1	024240281
TV280	21,00	1	024000478

T285



- 1112 250 mm
- 1128BM -
- 1726 400 mm
- 1728BM (5)
- 1753 200 cc

1,5 kg



T285	111,00	1	024240285
TV285	35,00	1	024000487

T284



- 1128BMX
- 1130BMX
- 1719BMA...Q 200 mm
- ▲ 1719BMA...T 200 mm
- 1719BMA...P 200 mm
- ▶ 1719BMA...M 200 mm
- 1719BMA...R 200 mm
- 1726BM 400 mm
- 1728BM
- 1771BM 170 mm
- 1778V18 185 mm

3,3 kg



T284	236,00	1	024240284
TV286	42,00	1	024249904

T289



- 1692 5 m
- 1725CR -
- 1755 30 cc
- 1771 -

500 g



T289	44,50	1	024240289
TV290	21,00	1	024000455

T291



- 1479RB/1
- 1479RB/2
- 1479RB/3

600 g



T291	93,50	1	024240291
TV291	21,00	1	024000472

T297



1651DGT
1682
1691BM

490 g



	€	1	024240297
T297	156,00	1	024240297
TV296	21,00	1	024000749

VP1 - VP2

thermoformed trays for small items,
made from plastic
for all roller cabs C22, C23, C23C

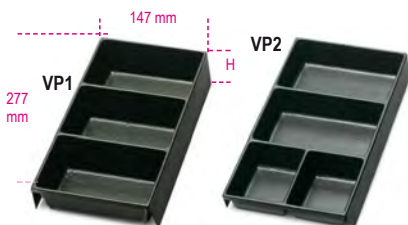

	H mm	€	1	088880351
VP1	50	12,10	1	088880351
VP2	35	12,10	1	088880352

VP3 - VP4

thermoformed trays for small items,
made from plastic
for all roller cabs and all trolleys

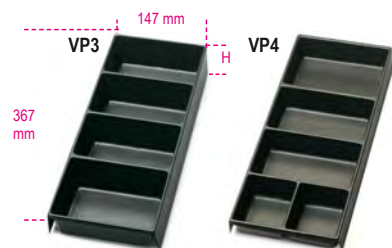

	H mm	€	1	088880353
VP3	50	12,70	1	088880353
VP4	35	12,70	1	088880354

VP5

thermoformed tray



	€	1	088880355
VP5	14,30	1	088880355



VP6

thermoformed tray

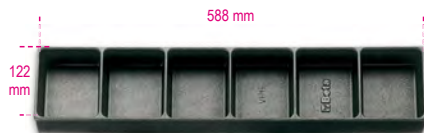

	€	1	088880359
VP6	14,60	1	088880359

VP-3SC

thermoformed tool trays,
made from plastic,
for mobile roller cab C38 +C04TSS-7

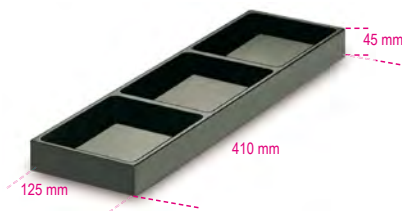

	H mm	€	1	088880356
VP-3SC	45	15,30	1	088880356

VP-LS

thermoformed tool trays,
made from plastic,
for mobile roller cab C38 +C04TSS-7



	H mm	€	1	088880357
VP-LS	45	10,50	1	088880357

VP-LD

thermoformed tool trays,
made from plastic,
for mobile roller cab C38



	H mm	€	1	088880358
VP-LD	45	10,00	1	088880358

8889P1

parallel partitions for item RSC22 e C27S

drawer 588x257 mm

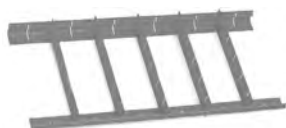

	h	€	1	088890005
8889P1/5	50 mm	40,50	1	088890005
8889P1/7	70 mm	41,50	1	088890007

8889C1

crossed partitions for item RSC22 and C27S

for drawer 588x257 mm

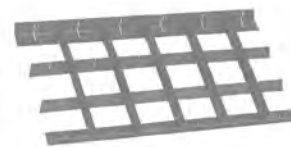

	h	€	1	088890015
8889C1/5	50 mm	54,00	1	088890015
8889C1/7	70 mm	55,00	1	088890017

8889P2

parallel partitions for standard drawer 588x367 mm



	h	€	1	088890107
8889P2/7	70 mm	48,50	1	088890107

8889C2

crossed partitions for standard drawer
588x367 mm



	h	€	1	088890117
8889C2	70 mm	62,00	1	088890117

8889P3

parallel partitions for item RSC24AXL

for drawer 882x367 mm



	h	€	1	088890207
8889P3	70 mm	77,50	1	088890207

8889C3

crossed partitions for RSC24AXL

for drawer 882x367 mm



	h	€	1	088890217
8889C3	70 mm	94,50	1	088890217

8889P4

parallel partitions for item C41

for drawer 418x205 mm



8889P4	h 70 mm	€ 32,50		1	088890307
--------	------------	------------	--	---	-----------

8889I4

crossed partition for item trolley C41

for drawer 418x205 mm



8889C4	h 70 mm	€ 39,50		1	088890317
--------	------------	------------	--	---	-----------

8889PS

parallel partitions for item C38 - C45PRO M4/M5/M7

left side drawer 570x410 mm

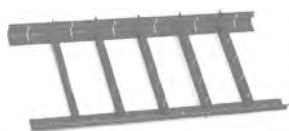

8889PS/7	h 70 mm	€ 57,50		1	088890407
----------	------------	------------	--	---	-----------

8889CS

crossed partitions for item C38 - C45PRO M4/M5/M7

left side drawer 570x410 mm

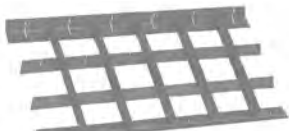

8889CS/7	h 70 mm	€ 70,00		1	088890417
----------	------------	------------	--	---	-----------

8889PD

parallel partitions for item C38

right side drawer 313x410 mm



8889PD/7	h 70 mm	€ 30,50		1	088890427
----------	------------	------------	--	---	-----------

8889CD

crossed partitions for item C38

right side drawer 313x410 mm



8889CD/7	h 70 mm	€ 42,50		1	088890437
----------	------------	------------	--	---	-----------

8889C6

crossed partitions for item C35

for drawer 600x447 mm



8889C6/7,5	h 75 mm	€ 30,00		1	088890475
8889C6/10	100 mm	29,50		1	088890480
8889C6/15	150 mm	36,50		1	088890485
8889C6/20	200 mm	57,00		1	088890490

SB

socket rails



	L mm	€		10	
SB1	210	3,05		10	088880201
SB2	280	3,40		10	088880202
SB3	360	3,60		10	088880203

PM 1/2-Q5

magnetic socket rail

12"



PM 1/2-Q5	€ 37,00		1	088880233
-----------	------------	--	---	-----------

MB

socket clips for rails SB



MB0	1/4	€ 0,91		50	088880210
MB1	3/8	0,91		50	088880211
MB2	1/2	0,91		50	088880212

KIT/GPS

kit of 40-mm GPS hooks with screws VE1

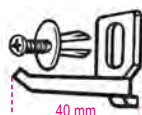

KIT/GPS	€ 1,76		50	088880119
---------	-----------	--	----	-----------

VE1

expansion bolts



VE1	€ 0,62		20	088880120
-----	-----------	--	----	-----------

GM

snap hooks with screw



Ø mm	€		5	
6,5	5,40		5	088880250
9,5	5,60		5	088880251
13	5,60		5	088880252
16	5,70		5	088880253
19	5,90		5	088880254
25	5,60		5	088880255

S55/8

supports for double open end wrenches

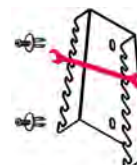

S55/8	€ 19,30		1	088880420
-------	------------	--	---	-----------

55/S8
55AS/8
55MP/S8

S55/12

supports for double open end wrenches

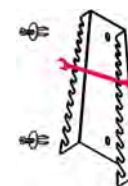

S55/12	€ 23,90		1	088880421
--------	------------	--	---	-----------

55/S12
55/S12X
55AS/12
55MP/S12

ST2P

pliers pocket

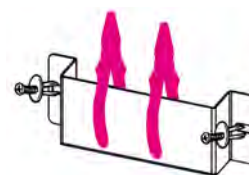

ST2P	€ 21,00		1	088880422
------	------------	--	---	-----------

TSPP

tool pockets



TSPP	€ 4,75		1	088880402
------	-----------	--	---	-----------

S952/10

supports for T-handle wrenches with swivelling socket

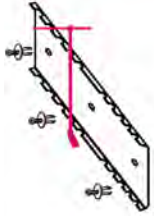

S952/10 € 25,50 1 088880423

S1719BM

supports for files



S1719BM € 14,60 1 088880404
1719BMA: Q-T-P-M-R
1719BMD: Q-T-P-M-R

SGN

supports for mini screwdrivers

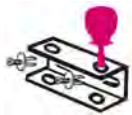

SGN € 7,40 1 088880405
1290N-1292N-1299N/PZ
1260N-1262N-1269N/PZ
1201EN-1202EN-1209EN/PZ

CB/2

thermoformed tray for 1/2" sockets and accessories, empty
Only for item C54S

12"

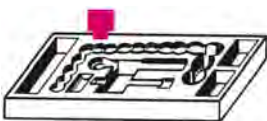

CB/2 € 22,20 1 088880411
920A/920B
10÷24+26-27
28-30-32 mm
920/21-920/22-920/25-
920/42-920/55

S42/17

supports for combination wrenches

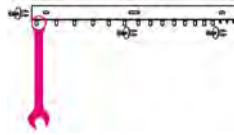

S42/17 € 24,90 1 088880428
42/S17
42MP/S17
42/S17X
42AS/17
142/S17

S951/6

supports for T handle wrenches with hexagon male ends

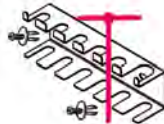

S951/6 € 16,50 1 088880429
951/S6
951AS/S6X
951TX/S6

SPG11 - S1203/8

supports for screwdrivers



SPG11 € 17,10 1 088880910
n.8 Ø = 7 mm
n.2 Ø = 10 mm
n.1 Ø = 12 mm
S1203/8 € 18,20 1 088880430
1203E/S8
1263/D8
1293/S8

S96T/8

supports for hexagon key wrenches



S96T/8 € 18,20 1 088880431

96T/SPV

supports for items 96T and 97TTX

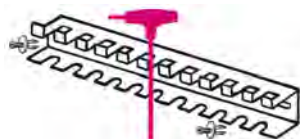

96T/SPV € 32,50 1 000960958
96T/S11
97TTX/S11



Beta CHEMICALS

Tightening a bolt is not always enough to guarantee secure tightening. Cleaning, lubrication and sealing are also necessary.

The range comprises anaerobic sealants, cyanoacrylate adhesives and aerosol cans for maintaining, cleaning and lubricating mechanical parts.

Anaerobic Products

Anaerobic products allow complete filling of small superficial irregularities in metal, so that mechanical stress can be distributed throughout the connecting surface. They harden in total absence of oxygen and completely seal joints or threads from water, gas, oil, fuel and industrial fluids.

They are available in three different strengths – high (H), medium (M) and low (L) – and in different packs, to satisfy different needs.

Silicone sealant

- Enables permanent elastic sealing.
- Replaces preformed gaskets.
- The convenient dispenser allows easy (one-coated), accurate, uniform spreading of the product.
- Polymerizes by reacting with atmospheric moisture and forms an elastic, durable gasket.

Instant Glue

Adhesive based on ethyl cyanoacrylate, for structural joints in a number of materials.

Aerosols

A wide range of products in spray cans, for use for unlocking, greasing, lubricating, cleaning, galvanizing and sanitizing purposes.

Liquids

Developed to remove encrustations and rust from mechanical parts and metal objects. Ideal for use with ultrasonic cleaning tanks 1895.



ATTENTION!

Countries where the products of the Beta Chemicals range are allowed to be distributed: Austria, Belgium, China, Czech Republic, France, Hungary, Italy, Netherlands, Poland, Portugal, Republic of Ireland, Slovakia, Slovenia, Spain, Switzerland, United Kingdom, United Arab Emirates.

9803H

threadlocker-High Resistance

Ideal for permanent locking of parts that do not need subsequent dismantling, and for passivated metal surfaces, including brass, aluminium and stainless steel. Does not allow disassembly with hand tools.



Temperature range (°C)	-50/+150
Max gap fill (mm)	0,25
Handling cure time (minutes)	10/15
Functional cure time (h)	3-6
Viscosity (mPa.s) 25°C	800/1200
Breakaway torque ISO-10964	35-45 Nm
Prevailing torque ISO-10964	30-40 Nm

ml			
20	bottle	12	098030002
50	bottle	4	098030005
250	bottle	4	098030025
20	bottle	12	098032002
50	bottle	4	098032005
250	bottle	4	098032025

9802M

threadlocker-Medium Resistance

Ideal for fixing parts subject to periodic maintenance, bearings and bushes. Allows dismantling by using hand tools.



Temperature range (°C)	-50/+150
Max gap fill (mm)	0,15
Handling cure time (minutes)	10/15
Functional cure time (h)	3-6
Viscosity (mPa.s) 25°C	500/800
Breakaway torque ISO-10964	22-30 Nm
Prevailing torque ISO-10964	20-25 Nm

ml			
20	bottle	12	098020002
50	bottle	4	098020005
250	bottle	4	098020025
20	bottle	12	098022002
50	bottle	4	098022005
250	bottle	4	098022025

9801L

threadlocker-Low Resistance

Ideal for fixing particular light alloys which could get damaged during disassembly and for adjusting screws. Easier parts disassembly.



Temperature range (°C)	-50/+150
Max gap fill (mm)	0,10
Handling cure time (minutes)	10/15
Functional cure time (h)	3-6
Viscosity (mPa.s) 25°C	500/800
Breakaway torque ISO-10964	6-10 Nm
Prevailing torque ISO-10964	4-8 Nm

ml			
20	bottle	12	098010002
50	bottle	4	098010005
250	bottle	4	098010025
20	bottle	12	098012002
50	bottle	4	098012005
250	bottle	4	098012025

9813H

thread sealant-High Resistance

Ideal for permanent sealing of nipples, that do not need subsequent dismantling, and for passivated metal surfaces, including brass, aluminium and stainless steel. Does not allow disassembly with hand tools.



Temperature range (°C)	-50/+200
Max gap fill (mm)	0,15
Handling cure time (minutes)	10/15
Functional cure time (h)	3-6
Viscosity (mPa.s) 25°C	40.000/80.000
Breakaway torque ISO-10964	35-45 Nm
Prevailing torque ISO-10964	25-35 Nm

ml			
20	bottle	12	098130002
50	bellow bottle	6	098130305
50	tube	4	098130505
100	tube	4	098130510
250	tube	4	098130525
20	bottle	12	098132002
50	bellow bottle	6	098132305
50	tube	4	098132505
100	tube	4	098132510
250	tube	4	098132525

9812M

thread sealant-Medium Resistance

Ideal for sealing nipples parts subject to periodic maintenance. Allows dismantling by using hand tools.



Temperature range (°C)	-50/+150
Max gap fill (mm)	0,35
Handling cure time (minutes)	12/18
Functional cure time (h)	3-6
Viscosity (mPa.s) 25°C	20.000/40.000
Breakaway torque ISO-10964	27-35 Nm
Prevailing torque ISO-10964	20-30 Nm

ml			
20	bottle	12	098120002
50	bellow bottle	6	098120305
50	tube	4	098120505
100	tube	4	098120510
250	tube	4	098120525
20	bottle	12	098122002
50	bellow bottle	6	098122305
50	tube	4	098122505
100	tube	4	098122510
250	tube	4	098122525

9811L

thread sealant-Low Resistance

Ideal for sealing small or fine-pitch joints. Easier parts disassembly.



Temperature range (°C)	-50/+150
Max gap fill (mm)	0,20
Handling cure time (minutes)	10/15
Functional cure time (h)	3-6
Viscosity (mPa.s) 25°C	10.000/20.000
Breakaway torque ISO-10964	6-10 Nm
Prevailing torque ISO-10964	4-8 Nm

ml			
20	bottle	12	098110002
50	bellow bottle	6	098110305
50	tube	4	098110505
100	tube	4	098110510
250	tube	4	098110525
20	bottle	12	098112002
50	bellow bottle	6	098112305
50	tube	4	098112505
100	tube	4	098112510
250	tube	4	098112525

9823H

liquid gasket-High Resistance

Ideal for permanent sealing of surfaces. Also ideal for reclaiming bearing housings and worn parts. Does not allow disassembly with hand tools.



Temperature range (°C)	-50/+150
Max gap fill (mm)	0,35
Handling cure time (minutes)	10/16
Functional cure time (h)	3-6
Viscosity (mPa.s) 25°C	100.000/200.000
Breakaway torque ISO-10964	35-45 Nm
Prevailing torque ISO-10964	20-30 Nm

ml			
20	bottle	12	098230002
50	bellow bottle	6	098230305
50	tube	4	098230505
100	tube	4	098230510
250	tube	4	098230525
20	bottle	12	098232002
50	bellow bottle	6	098232305
50	tube	4	098232505
100	tube	4	098232510
250	tube	4	098232525

9822M

liquid gasket-Medium Resistance

Ideal for sealing of surfaces of parts subject to periodic maintenance. Allows dismantling by using hand tools.



Temperature range (°C)	-50/+150
Max gap fill (mm)	0,35
Handling cure time (minutes)	10/15
Functional cure time (h)	3-6
Viscosity (mPa.s) 25°C	40.000/70.000
Breakaway torque ISO-10964	25-35 Nm
Prevailing torque ISO-10964	20-30 Nm

ml			
20	bottle	12	098220002
50	bellow bottle	6	098220305
50	tube	4	098220505
100	tube	4	098220510
250	tube	4	098220525
20	bottle	12	098222002
50	bellow bottle	6	098222305
50	tube	4	098222505
100	tube	4	098222510
250	tube	4	098222525

9821L

liquid gasket-Low Resistance

Ideal for sealing of surfaces of parts subject to frequent maintenance. Protects threads from corrosion and seizure from corrosion. Easier parts disassembly.



Temperature range (°C)	-50/+150
Max gap fill (mm)	0,35
Handling cure time (minutes)	20/30
Functional cure time (h)	3-6
Viscosity (mPa.s) 25°C	60.000/90.000
Breakaway torque ISO-10964	7-11 Nm
Prevailing torque ISO-10964	4-9 Nm

ml			
20	bottle	12	098210002
50	bellow bottle	6	098210305
50	tube	4	098210505
100	tube	4	098210510
250	tube	4	098210525
20	bottle	12	098212002
50	bellow bottle	6	098212305
50	tube	4	098212505
100	tube	4	098212510
250	tube	4	098212525

9833H

locker-High Resistance

Ideal for fixing parts that do not need subsequent dismantling. Also suitable for fixing already installed devices that are difficult to dismantle. Does not allow disassembly with hand tools.



Temperature range (°C)	-50/+180
Max gap fill (mm)	0,15
Handling cure time (minutes)	10/15
Functional cure time (h)	3-6
Viscosity (mPa.s) 25°C	400/700
Breakaway torque ISO-10964	35-45 Nm
Prevailing torque ISO-10964	30-40 Nm

ml			
20	bottle	12	098330002
50	bottle	4	098330005
250	bottle	4	098330025
20	bottle	12	098332002
50	bottle	4	098332005
250	bottle	4	098332025

9832M

locker-Medium Resistance

Ideal for fixing parts subject to periodic maintenance. Allows dismantling by using hand tools.



Temperature range (°C)	-50/+180
Max gap fill (mm)	0,25
Handling cure time (minutes)	12/20
Functional cure time (h)	3-6
Viscosity (mPa.s) 25°C	2000/4000
Breakaway torque ISO-10964	25-35 Nm
Prevailing torque ISO-10964	18-28 Nm

ml			
20	bottle	12	098320002
50	bottle	4	098320005
250	bottle	4	098320025
20	bottle	12	098322002
50	bottle	4	098322005
250	bottle	4	098322025

9831L

locker-Low Resistance

Ideal for fixing small parts subject to frequent maintenance. Easier parts disassembly.



Temperature range (°C)	-50/+150
Max gap fill (mm)	0,10
Handling cure time (minutes)	10/15
Functional cure time (h)	3-6
Viscosity (mPa.s) 25°C	500/800
Breakaway torque ISO-10964	6-10 Nm
Prevailing torque ISO-10964	4-8 Nm

ml			
20	bottle	12	098310002
50	bottle	4	098310005
250	bottle	4	098310025
20	bottle	12	098312002
50	bottle	4	098312005
250	bottle	4	098312025



9841N

black acetic-reticulation silicone sealant,
resistant to high temperatures,
with convenient pressure dispenser

Withstands temperatures up to 240 °C
Enables permanent elastic sealing. Replaces preformed gaskets.

The dispenser allows easy, accurate, uniform spreading of the product.

Polymerizes by reacting with atmospheric moisture and forms an elastic, durable gasket.

Ideal for oil sumps, oil pumps, housings, gearboxes, engine parts that are not subject to high pressure and applications that require resistance to high temperatures. Adheres to non-porous substrates, including glass, coated wood, ceramic and enamel. Not suitable for PE, PP, PC, PMMA, PTFE, soft plastics, neoprene and bituminous substrates. Cannot be painted.



ml		
200	12	098410120
200	12	098412120

9841R

red acetic-reticulation silicone sealant,
resistant to high temperatures,
with convenient pressure dispenser

Withstands temperatures up to 300 °C.
Enables permanent elastic sealing. Replaces preformed gaskets.

The dispenser allows easy, accurate, uniform spreading of the product.

Polymerizes by reacting with atmospheric moisture and forms an elastic, durable gasket.

Ideal for oven and furnace doors, plates, heating systems, outlets, thermostats, pumps, heating pipes, engine parts that are not subject to high pressure and applications that require resistance to high temperatures. Adheres to non-porous substrates, including glass, coated wood, ceramic and enamel. Not suitable for PE, PP, PC, PMMA, PTFE, soft plastics, neoprene and bituminous substrates. Cannot be painted.



ml		
200	12	098410020
200	12	098412020

9851

instant glue
for structural joints

based on ethyl cyanoacrylate
for adhesion of a wide range of materials, including metal, plastics, leather, wood and several other types of substrates, whether combined with each other or separate;
bonds quickly.



Temperature (°C)	-55/+82
Viscosity (mPa.s) 25 °C	80-120

g		
5	tube	24 098510500
20	bottle	12 098510002
50	bottle	10 098510005
500	bottle	1 098510050
5	tube	24 098512500
20	bottle	12 098512002
50	bottle	10 098512005
500	bottle	1 098512050

9710 - LUBRIBETA universal

7-in-1 multipurpose unlocking lubricant

1. Unlocking;
 2. Lubricating;
 3. Detergent, degreasing;
 4. Rust protective;
 5. Deoxidizing, for electrical contacts;
 6. Waterproof;
 7. Antifreezing.
- Silicone-free.



ml		
400	12	097100040
400	12	097101040
400	12	097102040



9712 - Ultra Sblock

unlocking lubricant, super-penetrating

Unlocking, deoxidizing, waterproof.
Ideal for dissolving rust from nuts, bolts, screws and gears.



ml		
400	12	097120040
400	12	097121040
400	12	097122040

9720 - Multi Grease

multipurpose grease

Particularly useful for lubricating chains, gears and moving metal parts. Resistant to friction and weather.
Highly adhesive. Does not drip.



ml		
400	12	097200040
400	12	097201040
400	12	097202040

9722 - Lithium Grease

white lithium grease

Based on grease with lithium, titanium and zinc oxide soaps.
Ideal for lubricating gears, bearings and joints.
Specific for marine applications.
Highly resistant to water, sea salt, weather and high temperatures.
Does not drip.



ml		
400	12	097220040
400	12	097221040
400	12	097222040

9724 - PTFE Grease

PTFE based grease

Particularly suitable for lubricating industrial chains and mechanical movements subject to heavy stress and low rotation speeds. Suitable for applications on plastics and rubber.

Totally colourless. Waterproof and resistant to oxidation.



ml		
400	12	097240040
400	12	097241040
400	12	097242040

9726 - Copper Grease

copper grease

Suitable for lubricating joints, bolts, gears, driveshafts and other metal parts subject to high temperatures (up to 1,000 °C).

Protective, anti-wear. Prevents oxidation.
Does not drip.



ml		
400	12	097260040
400	12	097261040
400	12	097262040

9729 - Silic Spray

silicone spray

Suitable for lubricating plastic, rubber and metal parts. Protects from corrosion. Detaching. Antistatic.

Waterproof. Can be used to polish wood, plastics and rubber. Solvent-free.



ml		
400	12	097290040
400	12	097291040
400	12	097292040

9738 - Cutting Oil

cutting oil

Highly lubricating and protective.

Suitable for milling, boring, threading, drilling and manual and automatic machine working.

Highly resistant to oxidation.

Water washable. Solvent-free.



ml		
400	12	097380040
400	12	097381040
400	12	097382040

9740 - Brake Cleaner

brake cleaner

Ideal for cleaning brake discs and pads, engines.

Removes grease and tar, without leaving residue.

Evaporates quickly.

Does not damage plastics and rubber.



ml		
500	12	097400050
500	12	097401050
500	12	097402050

9741 - Multi Cleaner

multipurpose detergent/degreaser

Detergent and degreaser for dissolving grease, oil, tar, silicone and glue.

Suitable for cleaning metal, hard plastic, ceramic, steel and aluminium surfaces.

Free from oil residues.



ml		
400	12	097410040
400	12	097411040
400	12	097412040

9742 - Contact Cleaner

cleaner for electric and electronic contacts

Removes grease and dirt, without leaving oily residue.

Evaporates quickly.

Does not damage plastics and rubber.



ml		
400	12	097420040
400	12	097421040
400	12	097422040

9743 - SURFACE CLEANER

foam detergent

Foam detergent for all types of surfaces, tools and fabrics.

Based on quaternary ammonium salts, it forms an active foam which cleans and removes dirt and grease.

Removes bad smells. No rinse required. Not a disinfectant.



ml		
500	12	097430050
500	12	097431050
500	12	097432050

9745 - Carb Cleaner

cleaner for carburettors and throttle bodies

Specific for interior and exterior cleaning of carburettors, suction ducts and throttle bodies.

Totally removes carbonaceous residue, deposits and impurities.

Does not leave oily residue.



ml		
400	12	097450040
400	12	097451040
400	12	097452040

9746 - Clima Cleaner

air conditioner cleaner

Cleaner for industrial, civil and car air conditioners. Based on its thick foam formulation and the straw supplied with it, it allows dirt, deposits and odours to be removed from ducts, leaving a pleasant fragrance.



ml		
400		12 097460040
400		12 097461040
400		12 097462040

9749 - Air Spray

air spray

Compressed gas aerosol spray. Ideal for removing dust deposits from cracks, gear, electrical parts, keyboards and delicate mechanisms in general. The aerosol can with straw allows hardly accessible parts to be easily reached.



ml		
400		12 097490040
400		12 097491040
400		12 097492040

9752 - Zinc 98%

clear zinc

Highly covering, it is ideal for galvanizing iron parts. Highly adhesive, it forms an elastic film of very light colour, similar to hot galvanizing. Particularly resistant to oxidation, abrasion and weather. Can be overpainted. Does not drip.



ml		
400		12 097520040
400		12 097521040
400		12 097522040

9755 - Welding Spray

welding anti-spatter spray

Silicone-free welding anti-spatter spray. It prevents slag adhesion, thereby making welding easier and quicker. For use on parts that need welding and as a protector for welding torch nozzles. It makes it possible to carry out subsequent operations, e.g. painting, galvanizing and chrome-plating. No fumes. Easy to remove. Chlorinated-free.



ml		
400		12 097550040
400		12 097551040
400		12 097552040

9765 - Deicer Spray

de-icer spray

De-icer and defroster spray, for removing ice and frost from windows. Also ideal for frozen locks and mechanisms. Effective down to -40 °C. Nongreasy, smear-free. Does not affect treated surfaces, rubber and plastics.



ml		
400		12 097650040
400		12 097651040
400		12 097652040

9775 - Water Stop

fabric waterproofing spray

Waterproofing, water-repellent spray for textiles and leather. Ideal for footwear, jackets and clothing in general. It allows fabrics to be waterproofed, without affecting breathability. Based on its stain resistance properties, fabrics are easier to wash. Improved resistance to bending and abrasion.



ml		
400		12 097750040
400		12 097751040
400		12 097752040

9881U

industrial alkaline detergent for ultrasonic tank

Industrial alkaline detergent, concentrated, water-based. For ultrasonic cleaning and other purification processes. Allows spare parts and metal pieces in general (injectors, carburetors, valves etc.) to be accurately and effectively cleaned.

Removes oil, grease, lubricants, residues of glue, resin and wax. Also suitable for cleaning aluminium parts.



Lt		
1		1 098810010
1		1 098812010

9882R

selective rust remover liquid

Water-based selective rust remover liquid for iron, steel, stainless steel, cast iron and chrome platings. Removes top oxidized layer, without affecting underlying metal.

Dilution: from pure to max. 1:1.

Minimum operating temperature: 15 °C.

Operating times: 30' - 24/48h (for heavy rust). Biodegradable and 100% water-soluble.



Lt		
1		1 098820010
1		1 098822010





A comprehensive range of hard and flexible abrasives, comprising over 500 coded items, entirely made in Italy. Designed and developed to satisfy all industrial and professional cutting and material removal requirements. Beta Utensili relies on the Beta Abrasives project to assert its determination to offer market professionals a comprehensive product range and an unequalled technical standard, resulting from the manufacturing skills contributed by AbraBeta.



HARD CUTTING AND GRINDING DISCS

Hard discs mean the main category of this new product family; hence Beta Utensili has concentrated on selecting the very best materials and types.

Cutting and grinding discs are the quickest and most versatile instruments for working a wide variety of materials, by using the most suitable tools, whether angle grinders or stationary machines

DISC SHAPES

 **T42**
cutting disc with depressed centre

 **T41**
cutting disc with flat centre

 **T27**
grinding disc with depressed centre

TOP
— LINE — Uncompromising quality: for extremely demanding users

PREMIUM
— LINE — High quality for high performance, at competitive prices, for the best quality/price ratio.

CERTIFICATION  

PICTOGRAMS on discs

 Wear safety glasses

 Wear ear protectors

 Wear dust mask

 Wear protector gloves

 Wear safety clothes

 Check user manual

 Disc for cutting only – not for grinding

 Do not use disc if damaged

 Iron, sulphur and chlorine free ($\leq 0.1\%$)

Product shelf life

Product shelf-life: 3 years from manufacturing date. "V01" as engraved on the metal washer in the middle of the disc indicates the quarter of expiration. Example: "V07/2022" indicates the disc was manufactured in the 3rd quarter of 2019 and can be used until the end of the 3rd quarter of 2022.



	Quarter
V01	Jan-Mar
V04	Apr-Jun
V07	Jul-Sep
V10	Oct-Dec



ABRASIVE SHAFT-MOUNTED WHEELS

Abrasive shaft-mounted wheels for use with die grinders. Made in several shapes to suit different working processes, with three types of abrasives.



SHAFT-MOUNTED WHEELS

Shaft-mounted flap wheels are provided with flexible flaps which allow precise, homogenous finish to be obtained on irregular shapes and surfaces.



FLAP DISCS

Flap discs are made up of abrasive cloth flaps glued onto a support; they are an excellent choice for roughing and finishing operations. Generally speaking, they ensure quicker removal, more homogenous finish, less vibration, less noise and lower operating temperatures than grinding discs. They are available with cloths made of several different abrasive materials, with different grain sizes and two different types of support.

Shapes

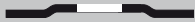

Flat

Used at a maximum angle of 15° compared to the worktop, it allows working of flat surfaces and edges.



Conical

Used at an angle between 15° and 25° compared to the worktop, it makes jobs on uneven surfaces easier. It ensures a larger contact surface between the disc and the surface being worked. The flaps can be used until they are fully worn out.



Uncompromising quality: for extremely demanding users.



High quality for high performance, at competitive prices, for the best quality/price ratio.



WHEELS WITH BORES

Flange flap wheels are suitable for working irregular edges, contours and surfaces based on high flap flexibility.



WHEELS FOR SATINIZING MACHINES

Beta's wheels (or rollers) for satinizing machines mean the best solution for finishing any material.

Gradi di grana/finitura

C	Coarse
M	Medium
F	Fine
VF	Very Fine
UF	Ultra fine



RADIAL DISCS AND FIBRE DISCS

Special nonwoven discs producing remarkable polishing effects, resulting in quick, precise working processes.



ANTI-WASTE ROLLS

A wide range of anti-waste rolls made of abrasive cloth and paper or nonwoven, of excellent quality, for a number of uses.

For further information, please refer to the dedicated catalogue available on Beta's website:

www.beta-tools.com

11001

abrasive steel cutting discs
with depressed centre

A30S EN 12413



A30S

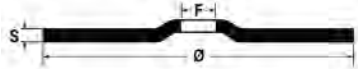

	Ø	S	F	max.	€		
	mm	mm	mm	rpm			
11001	115	3,2	22,23	13300	1,32	10	110010118
11001	125	3,2	22,23	12200	1,44	10	110010128
11001	230	3,2	22,23	6600	2,89	10	110010233

11001H

abrasive steel cutting discs
with depressed centre

HARD

A30T EN 12413



A30T



	Ø	S	F	max.	€		
	mm	mm	mm	rpm			
11001H	230	3,2	22,23	6600	2,89	10	110010733

11003

abrasive steel cutting discs
with flat centre

A30T EN 12413



A30T

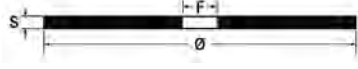

	Ø	S	F	max.	€		
	mm	mm	mm	rpm			
11003	115	2,5	22,23	13300	1,26	10	110030117
11003	125	2,5	22,23	12200	1,32	10	110030127
11003	180	2,5	22,23	8500	2,26	10	110030182
11003	230	2,5	22,23	6600	2,84	10	110030232

11011

abrasive steel grinding discs
with depressed centre

A24N EN 12413



A24N



	Ø	S	F	max.	€		
	mm	mm	mm	rpm			
11011	115	6,5	22,23	13300	1,75	10	110110115
11011	125	6,5	22,23	12200	1,89	10	110110125
11011	180	6,5	22,23	8500	3,45	10	110110180
11011	230	6,5	22,23	6600	4,75	10	110110230

11011H

abrasive steel grinding discs
with depressed centre

HARD

A24R EN 12413



A24R



	Ø	S	F	max.	€		
	mm	mm	mm	rpm			
11011H	115	6,5	22,23	13300	1,75	10	110110615
11011H	125	6,5	22,23	12200	1,89	10	110110625
11011H	180	6,5	22,23	8500	3,45	10	110110680
11011H	230	6,5	22,23	6600	4,75	10	110110730

11018

abrasive ultra-thin steel cutting discs
with flat centre

60 m/s

A46N EN 12413



A46N

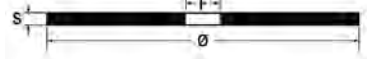

	Ø	S	F	max.	€		
	mm	mm	mm	rpm			
11018	300	2,5	25,40	4010	4,60	10	110180030
11018	350	3,0	25,40	3440	7,80	10	110180035
11018	400	3,2	25,40	3010	9,20	10	110180040

11019

abrasive ultra-thin steel cutting discs
with flat centre

80 m/s

A24N EN 12413



A24N



	Ø	S	F	max.	€		
	mm	mm	mm	rpm			
11019	300	3,8	25,40	5100	5,50	10	110190030
11019	350	4,2	25,40	4400	8,20	10	110190035
11019	400	4,5	25,40	3800	11,00	10	110190040

11021

abrasive steel and stainless steel cutting discs
with depressed centre

A30Q EN 12413



A30Q



	Ø	S	F	max.	€		
	mm	mm	mm	rpm			
11021	115	3,2	22,23	13300	1,36	10	110210118
11021	125	3,2	22,23	12200	1,49	10	110210128
11021	180	3,2	22,23	8500	2,40	10	110210183
11021	230	3,2	22,23	6600	2,99	10	110210233

11023

abrasive steel and stainless steel grinding discs
with depressed centre

A24Q EN 12413



A24Q



	Ø	S	F	max.	€		
	mm	mm	mm	rpm			
11023	115	6,5	22,23	13300	1,75	10	110230115
11023	125	6,5	22,23	12200	1,89	10	110230125
11023	230	6,5	22,23	6600	4,75	10	110230230

11024

abrasive steel and stainless steel cutting discs,
thin, with depressed centre

TOP LINE

A46U EN 12413



TOP
LINE

A46U



	Ø	S	F	max.	€		
	mm	mm	mm	rpm			
11024	230	2,0	22,23	6600	3,35	10	110240230

11031÷11038

abrasive steel and stainless steel cutting discs,
thin, with flat centre

TOP LINE

Ø 65 mm

A46U EN 12413



TOP
LINE

A46U

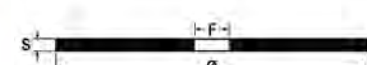

	Ø	S	F	max.	€		
	mm	mm	mm	rpm			
11031	65	1,0	6,00	24000	1,16	25	110310006
11031	65	1,0	10,00	24000	1,16	25	110310010
11031	65	1,6	10,00	24000	1,16	25	110310020

	Ø	S	F	max.	€		
	mm	mm	mm	rpm			
11032	76	1,0	6,00	20200	1,16	25	110320006
11032	76	1,0	10,00	20200	1,16	25	110320010
11032	76	1,6	10,00	20200	1,16	25	110320020

	Ø	S	F	max.	€		
	mm	mm	mm	rpm			
11034	115	1,0	22,23	13300	1,65	25	110340022
11034	115	1,2	22,23	13300	1,65	25	110340042
11034	115	1,6	22,23	13300	1,65	25	110340062

	Ø	S	F	max.	€		
	mm	mm	mm	rpm			
11035	125	1,0	22,23	12200	1,78	25	110350022
11035	125	1,2	22,23	12200	1,78	25	110350042
11035	125	1,6	22,23	12200	1,78	25	110350062

	Ø	S	F	max.	€		
	mm	mm	mm	rpm			
11037	180	2,0	22,23	8500	2,78	10	110370022

	Ø	S	F	max.	€		
	mm	mm	mm	rpm			
11038	230	2,0	22,23	6600	3,25	10	110380022

11040

abrasive steel and stainless steel cutting discs,
thin, with depressed centre

PREMIUM LINE

A36Q EN 12413



A36Q

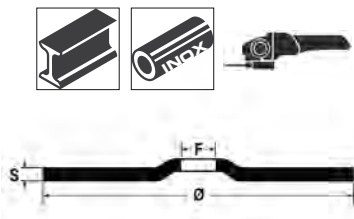

	Ø	S	F	max.	€		
	mm	mm	mm	rpm			
11040	230	2,0	22,23	6600	2,92	10	110400230

11045-11046

abrasive steel and stainless steel cutting discs,
thin, with flat centre

PREMIUM LINE

Ø 115 mm

A46Q EN 12413



A46Q

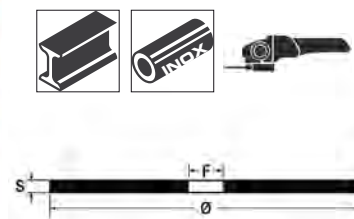

	Ø	S	F	max.	€		
	mm	mm	mm	rpm			
11045	115	1,0	22,23	13300	1,37	25	110450010
11045	115	1,2	22,23	13300	1,37	25	110450012
11045	115	1,6	22,23	13300	1,37	25	110450016

	Ø	S	F	max.	€		
	mm	mm	mm	rpm			
11046	125	1,0	22,23	12200	1,45	25	110460010
11046	125	1,2	22,23	12200	1,45	25	110460012
11046	125	1,6	22,23	12200	1,45	25	110460016

11048-11049

abrasive steel and stainless steel cutting discs,
thin, with flat centre

Ø 180 mm

A36Q EN 12413



A36Q

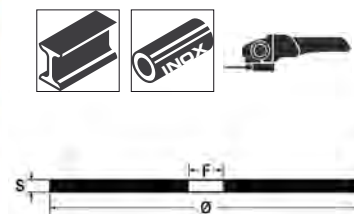

	Ø	S	F	max.	€		
	mm	mm	mm	rpm			
11048	180	2,0	22,23	8500	2,38	10	110480019

	Ø	S	F	max.	€		
	mm	mm	mm	rpm			
11049	230	2,0	22,23	6600	2,72	10	110490019

11050

abrasive steel grinding discs,
with zirconia abrasive and depressed centre

ZA24R - EN 12413



ZA24R



	Ø	S	F	max.	€		
	mm	mm	mm	rpm			
11050	115	6,5	22,23	13300	2,75	10	110500115
11050	125	6,5	22,23	12200	3,10	10	110500125
11050	180	7,0	22,23	8500	6,10	10	110500180
11050	230	7,0	22,23	6600	9,45	10	110500230

11069

abrasive stone and marble cutting discs
with depressed centre

C30S EN 12413



C30S



	Ø	S	F	max.	€		
	mm	mm	mm	rpm			
11069	115	3,2	22,23	13300	1,43	10	110690115
11069	125	3,2	22,23	12200	1,56	10	110690125
11069	230	3,2	22,23	6600	3,15	10	110690230

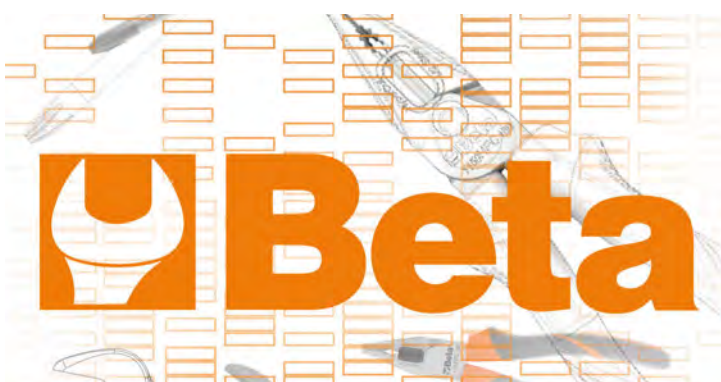

11100

abrasive shaft-mounted wheels,
abrasive pink corundum grains,
cylindrically shaped

shaft \varnothing 3 x 37 mm

EN 12413

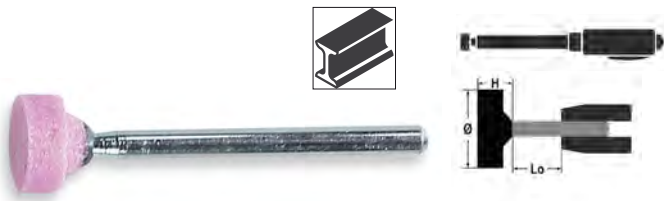

	\varnothing mm	h mm	max. rpm Lo=13 mm		€		
11100	4	8	130.000	AR60P5V	0,80	25	111000004
11100	6	10	93.100	AR60P5V	0,80	25	111000006
11100	8	12	64.500	AR60P5V	0,80	25	111000008
11100	10	10	60.100	AR60P5V	0,80	25	111000011
11100	10	12	52.700	AR60P5V	0,80	25	111000012
11100	12	15	37.300	AR60P5V	0,89	25	111000013

11101

abrasive shaft-mounted wheels,
abrasive pink corundum grains,
cylindrically shaped

shaft \varnothing 6 x 40 mm

EN 12413

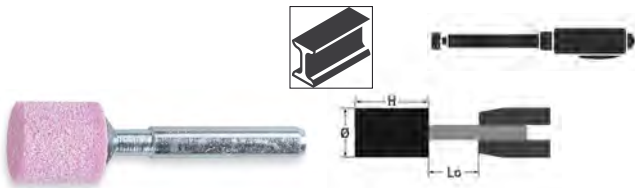

	\varnothing mm	h mm	max. rpm Lo=13 mm		€		
11101	4	8	130.000	AR60P5V	0,94	25	111010004
11101	5	10	130.000	AR60P5V	0,94	25	111010005
11101	6	10	130.000	AR60P5V	0,94	25	111010006
11101	8	10	119.300	AR60P5V	0,94	25	111010008
11101	10	10	95.400	AR60P5V	0,94	25	111010010
11101	10	15	95.400	AR60P5V	0,94	25	111010011
11101	10	20	86.600	AR60P5V	1,03	25	111010012
11101	10	25	72.700	AR60P5V	1,13	25	111010013
11101	10	32	58.700	AR60P5V	1,19	25	111010014
11101	12	10	79.500	AR60P5V	0,87	25	111010015
11101	12	15	79.500	AR60P5V	0,89	25	111010016
11101	12	20	79.500	AR60P5V	0,97	25	111010017
11101	15	3	63.600	AR60P5V	0,87	25	111010018
11101	15	15	63.600	AR60P5V	0,94	25	111010019
11101	16	20	59.600	AR46P5V	1,06	25	111010020
11101	16	25	56.900	AR46P5V	1,13	25	111010021
11101	16	32	45.100	AR46P5V	1,28	25	111010022
11101	20	4	47.700	AR60P5V	0,87	25	111010023
11101	20	15	47.700	AR46P5V	0,94	25	111010024
11101	20	20	47.700	AR46P5V	1,13	25	111010025
11101	20	25	46.100	AR46P5V	1,19	25	111010026
11101	20	30	38.900	AR46P5V	1,30	25	111010027
11101	20	40	29.000	AR46P5V	1,64	25	111010028
11101	25	10	38.100	AR60P5V	0,94	25	111010030
11101	25	25	37.200	AR36/46P5V	1,30	25	111010031
11101	25	40	23.300	AR36/46P5V	1,92	10	111010032
11101	30	10	31.800	AR60P5V	1,06	25	111010034
11101	30	30	26.200	AR36/46P5V	1,56	25	111010035
11101	30	40	19.500	AR36/46P5V	2,08	10	111010036
11101	32	20	29.800	AR36P5V	1,47	25	111010037
11101	32	32	23.100	AR36P5V	2,00	10	111010038
11101	40	10	23.800	AR36/46P5V	1,56	25	111010041
11101	40	20	23.800	AR36P5V	2,08	10	111010042
11101	40	25	23.400	AR36P5V	2,19	10	111010043
11101	40	30	19.700	AR36P5V	2,39	10	111010044
11101	40	40	14.700	AR36P5V	2,91	10	111010045
11101	50	15	19.000	AR36P5V	2,33	10	111010051
11101	50	25	18.800	AR36P5V	2,77	10	111010052
11101	60	10	15.900	AR36P5V	2,58	10	111010060

11102

abrasive shaft-mounted wheels,
abrasive pink corundum grains,
cylindrically shaped

shaft \varnothing 6 x 80 mm

EN 12413

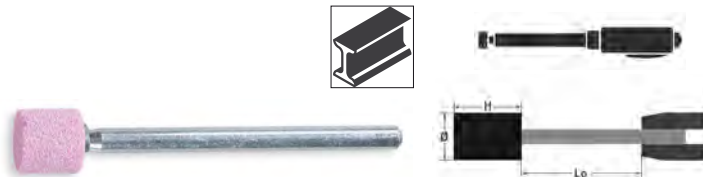

	\varnothing mm	h mm	max. rpm Lo=13 mm		€		
11102	8	20	100.500	AR60P5V	1,23	25	111020008
11102	10	15	95.400	AR60P5V	1,16	25	111020010
11102	10	30	62.200	AR60P5V	1,42	25	111020020
11102	12	15	79.500	AR60P5V	1,19	25	111020022
11102	15	15	63.600	AR60P5V	1,28	25	111020035
11102	15	30	51.000	AR46P5V	1,59	25	111020040
11102	20	30	38.900	AR46P5V	1,61	25	111020060

11105

abrasive shaft-mounted wheels,
abrasive pink corundum grains,
cylindrically/triangularly shaped

shaft \varnothing 6 x 40 mm

EN 12413



	\varnothing mm	h mm	max. rpm Lo=13 mm		€		
11105	20	65	16.200	AR36/46P5V	3,05	25	111050020

11106

abrasive shaft-mounted wheels,
abrasive pink corundum grains,
trapezoidally shaped

shaft \varnothing 3 x 37 mm

EN 12413

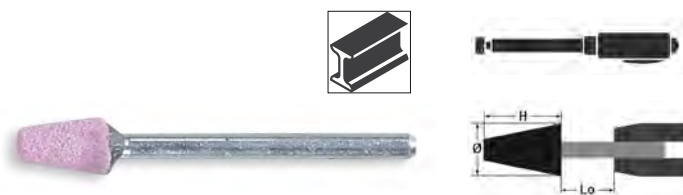

	\varnothing mm	h mm	max. rpm Lo=13 mm		€		
11106	6	10	93.100	AR60P5V	1,06	25	111060006

11107

abrasive shaft-mounted wheels,
abrasive pink corundum grains,
trapezoidally shaped

shaft Ø 6 x 40 mm

EN 12413

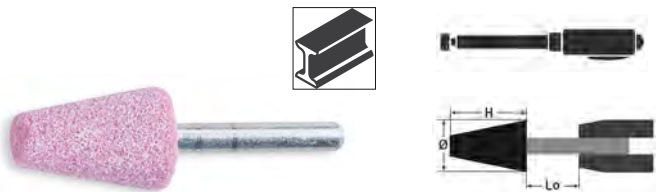

	Ø mm	h mm	max. rpm Lo=13 mm		€		
11107	12	20	79.500	AR60P5V	1,19	25	111070012
11107	15	25	60.400	AR46P5V	1,42	25	111070015
11107	20	30	38.900	AR46P5V	1,64	25	111070020
11107	25	40	23.300	AR36/46P5V	2,39	10	111070025

11110

abrasive shaft-mounted wheels,
abrasive pink corundum grains,
rounded, cone-shaped

shaft Ø 3 x 37 mm

EN 12413

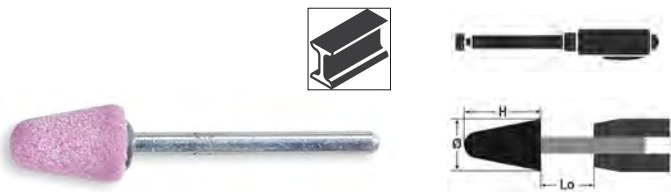

	Ø mm	h mm	max. rpm Lo=13 mm		€		
11110	10	15	44.300	AR60P5V	1,06	25	111100010

11111

abrasive shaft-mounted wheels,
abrasive pink corundum grains,
rounded, cone-shaped

shaft Ø 6 x 40 mm

EN 12413

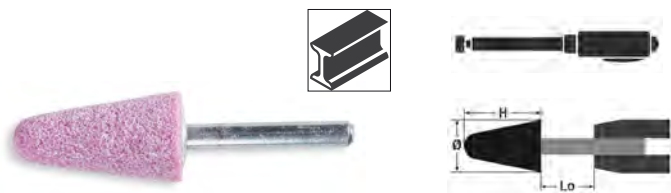

	Ø mm	h mm	max. rpm Lo=13 mm		€		
11111	10	20	86.600	AR60P5V	1,23	25	111110010
11111	15	30	51.000	AR46P5V	1,61	25	111110015
11111	16	45	31.400	AR46P5V	2,19	25	111110016
11111	20	28	41.500	AR46P5V	1,64	25	111110020
11111	20	40	29.000	AR46P5V	2,08	25	111110021
11111	30	50	15.100	AR36/46P5V	3,05	10	111110030

11115

abrasive shaft-mounted wheels,
abrasive pink corundum grains,
ogive-shaped

shaft Ø 3 x 37 mm

EN 12413

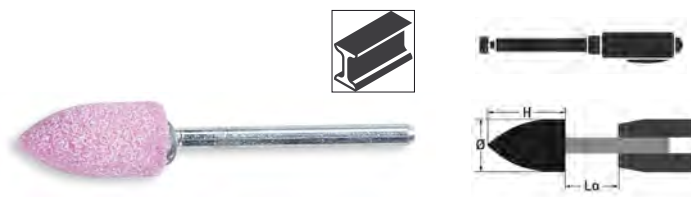

	Ø mm	h mm	max. rpm Lo=13 mm		€		
11115	10	20	34.700	AR60P5V	1,13	25	111150010

11116

abrasive shaft-mounted wheels,
abrasive pink corundum grains,
ogive-shaped

shaft Ø 6 x 40 mm

EN 12413

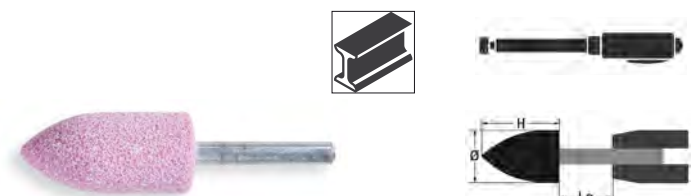

	Ø mm	h mm	max. rpm Lo=13 mm		€		
11116	10	20	86.600	AR60P5V	1,23	25	111160010
11116	18	30	43.000	AR46P5V	1,64	25	111160018
11116	20	50	22.500	AR36/46P5V	2,58	25	111160020
11116	22	70	13.400	AR36/46P5V	3,90	10	111160022

11120

abrasive shaft-mounted wheels,
abrasive pink corundum grains,
cylindrically/pyramidally shaped

shaft Ø 3 x 37 mm

EN 12413

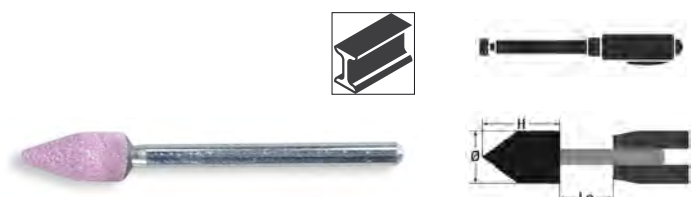

	Ø mm	h mm	max. rpm Lo=13 mm		€		
11120	6	13	77.800	AR60P5V	1,06	25	111200006

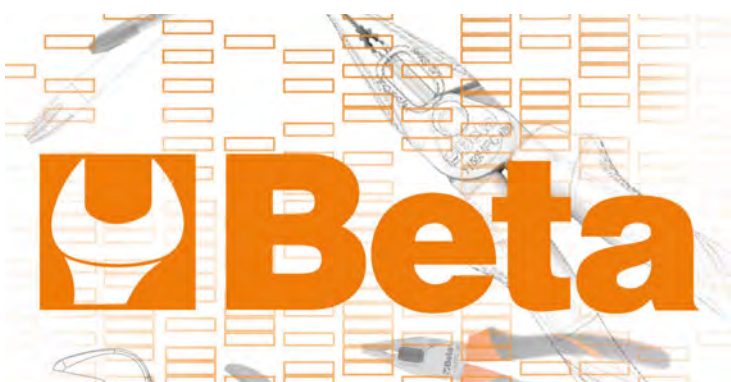

11121

abrasive shaft-mounted wheels,
abrasive pink corundum grains,
cylindrically/pyramidally shaped

shaft \varnothing 6 x 40 mm

EN 12413

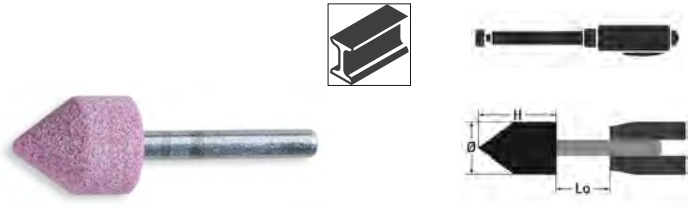

	\varnothing mm	h mm	max. rpm Lo=13 mm		€		
11121	6	25	100.700	AR60P5V	1,64	25	111210007
11121	12	20	79.500	AR60P5V	1,19	25	111210012
11121	20	25	46.100	AR46P5V	1,49	25	111210020
11121	25	25	37.200	AR36/46P5V	1,64	25	111210025
11121	30	30	26.200	AR36/46P5V	1,95	25	111210030

11125

abrasive shaft-mounted wheels,
abrasive pink corundum grains,
rounded, cylindrically shaped

shaft \varnothing 6 x 40 mm

EN 12413

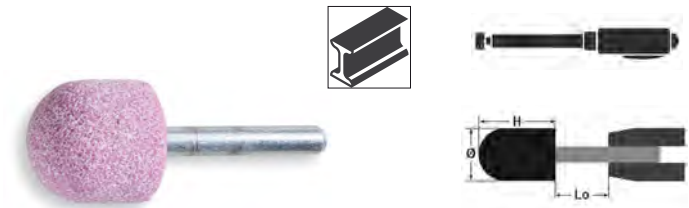

	\varnothing mm	h mm	max. rpm Lo=13 mm		€		
11125	6	20	117.700	AR60P5V	1,33	25	111250006
11125	25	25	37.200	AR36/46P5V	1,64	25	111250025
11125	30	50	15.100	AR36/46P5V	3,05	10	111250030
11125	40	40	14.700	AR36P5V	3,70	10	111250040

11130

abrasive shaft-mounted wheels,
abrasive pink corundum grains,
globe-shaped

shaft \varnothing 3 x 37 mm

EN 12413

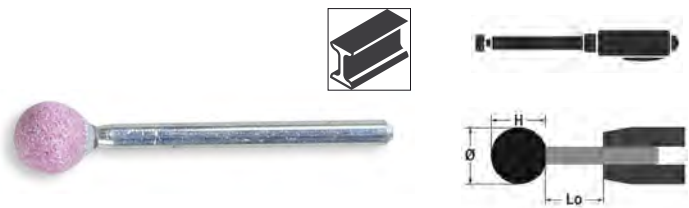

	\varnothing mm	h mm	max. rpm Lo=13 mm		€		
11130	6	6	124.900	AR60P5V	1,06	25	111300006
11130	8	8	84.800	AR60P5V	1,06	25	111300008
11130	10	10	60.100	AR60P5V	1,06	25	111300010

11131

abrasive shaft-mounted wheels,
abrasive pink corundum grains,
globe-shaped

shaft \varnothing 6 x 40 mm

EN 12413

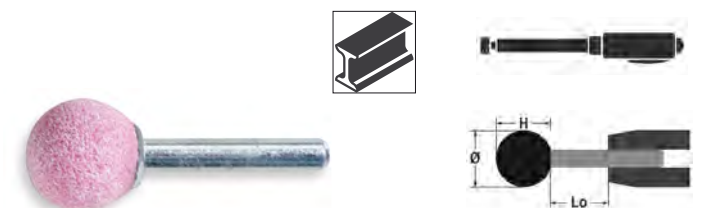

	\varnothing mm	h mm	max. rpm Lo=13 mm		€		
11131	10	10	95.400	AR60P5V	1,13	25	111310010
11131	15	15	63.600	AR60P5V	1,19	25	111310015
11131	20	20	47.700	AR46P5V	1,42	25	111310020
11131	25	25	37.200	AR36/46P5V	1,64	25	111310025
11131	30	30	26.200	AR36/46P5V	1,95	25	111310030

11132

abrasive shaft-mounted wheels,
abrasive pink corundum grains,
globe-shaped

shaft \varnothing 6 x 80 mm

EN 12413

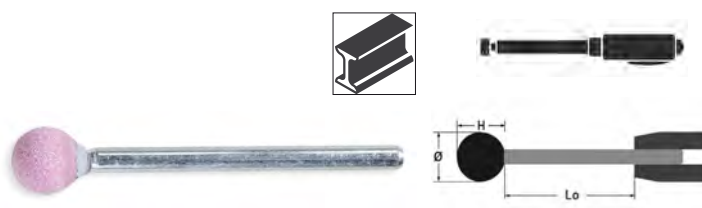

	\varnothing mm	h mm	max. rpm Lo=13 mm		€		
11132	10	10	95.400	AR60P5V	1,33	25	111320010
11132	15	15	63.600	AR60P5V	1,49	25	111320015
11132	20	20	47.700	AR46P5V	1,75	25	111320020

11135

abrasive shaft-mounted wheels,
abrasive pink corundum grains,
disc-shaped

shaft \varnothing 6 x 40 mm

EN 12413

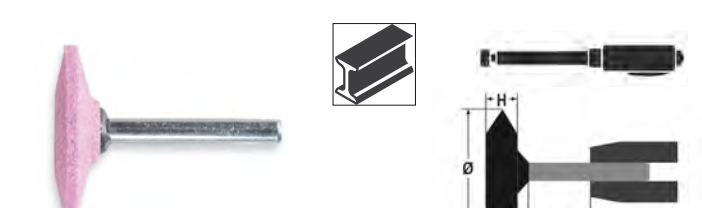

	\varnothing mm	h mm	max. rpm Lo=13 mm		€		
11135	30	6	31.800	AR60P5V	1,30	25	111350030
11135	40	10	23.800	AR36/46P5V	2,00	25	111350040

11140

abrasive shaft-mounted wheels,
abrasive grey/pink corundum grains,
cylindrically shaped

shaft \varnothing 6 x 40 mm

EN 12413



	\varnothing mm	h mm	max. rpm Lo=13 mm		€		
11140	20	30	38.900	A/AR24R5V	1,30	25	111400020
11140	25	25	37.200	A/AR24R5V	1,30	25	111400025
11140	30	30	26.200	A/AR24R5V	1,56	25	111400030
11140	50	10	19.000	A/AR24R5V	2,08	10	111400050

11141

abrasive shaft-mounted wheels,
abrasive grey/pink corundum grains,
cylindrically shaped

shaft \varnothing 6 x 80 mm

EN 12413



	\varnothing mm	h mm	max. rpm Lo=13 mm		€		
11141	20	40	46.800	A/AR24R5V	1,85	25	111410020
11141	30	40	31.800	A/AR24R5V	2,25	10	111410030
11141	40	40	23.800	A/AR24R5V	3,15	10	111410040

11145

abrasive shaft-mounted wheels,
abrasive grey/pink corundum grains,
ogive-shaped

shaft \varnothing 6 x 40 mm

EN 12413

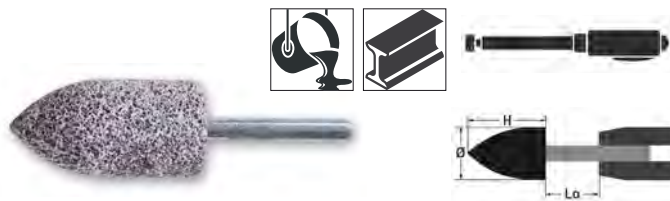

	\varnothing mm	h mm	max. rpm Lo=13 mm		€		
11145	20	30	38.900	A/AR24R5V	1,64	25	111450020
11145	25	50	18.100	A/AR24R5V	2,91	10	111450025

11200A-11200B

flap discs with zirconia abrasive cloth,
plastic backing pad, single flap construction

Flat
PREMIUM LINE
 \varnothing 115 mm
EN 13743

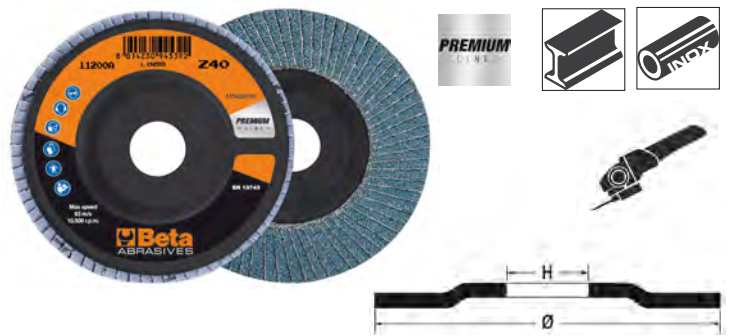

	\varnothing mm	P	F mm		€		
11200A	115	40	22,23		2,30	10	112000004
11200A	115	60	22,23		2,30	10	112000006
11200A	115	80	22,23		2,30	10	112000008
11200A	115	120	22,23		2,30	10	112000012

	\varnothing mm	P	F mm		€		
11200B	125	40	22,23		2,90	10	112000104
11200B	125	60	22,23		2,90	10	112000106
11200B	125	80	22,23		2,90	10	112000108

11202A÷11202C

flap discs with zirconia abrasive cloth,
plastic backing pad, double flap construction

Flat
PREMIUM LINE
 \varnothing 115 mm
EN 13743

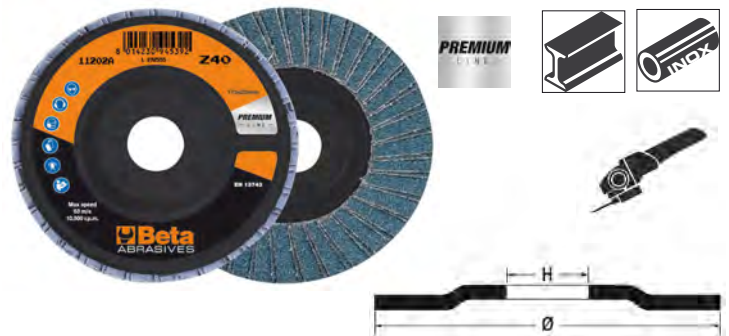

	\varnothing mm	P	F mm		€		
11202A	115	40	22,23		2,30	10	112020004
11202A	115	60	22,23		2,30	10	112020006
11202A	115	80	22,23		2,30	10	112020008
11202A	115	120	22,23		2,30	10	112020012

	\varnothing mm	P	F mm		€		
11202B	125	40	22,23		2,90	10	112020104
11202B	125	60	22,23		2,90	10	112020106
11202B	125	80	22,23		2,90	10	112020108

	\varnothing mm	P	F mm		€		
11202C	180	40	22,23		6,30	10	112020204
11202C	180	60	22,23		6,30	10	112020206

11204A÷11204C

flap discs with zirconia abrasive cloth,
fibreglass backing pad, single flap construction

Flat
PREMIUM LINE
Ø 115 mm
EN 13743

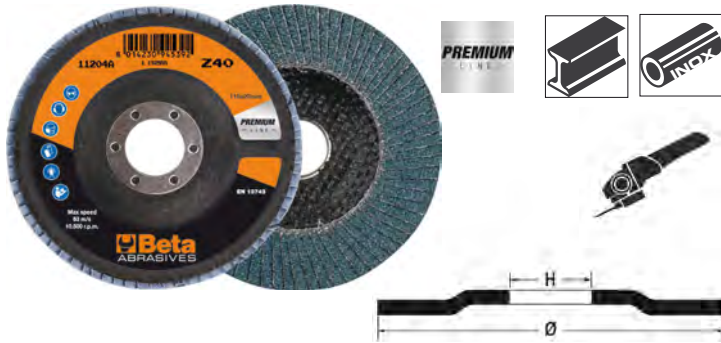

	Ø	P	F	€		
	mm		mm			
11204A	115	40	22,23	2,30	10	112040004
11204A	115	60	22,23	2,30	10	112040006
11204A	115	80	22,23	2,30	10	112040008
11204A	115	120	22,23	2,30	10	112040012

	Ø	P	F	€		
	mm		mm			
11204B	125	40	22,23	2,75	10	112040104
11204B	125	60	22,23	2,75	10	112040106
11204B	125	80	22,23	2,75	10	112040108

	Ø	P	F	€		
	mm		mm			
11204C	180	40	22,23	6,10	10	112040204
11204C	180	60	22,23	6,10	10	112040206

11208A-11208B

flap discs with zirconia abrasive cloth,
fibreglass backing pad, double flap construction

Flat
PREMIUM LINE
Ø 115 mm
EN 13743

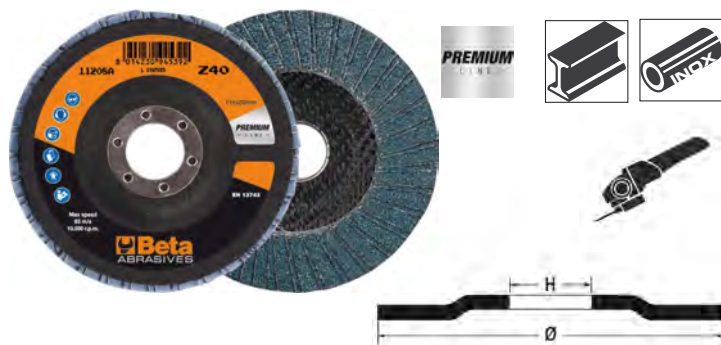

	Ø	P	F	€		
	mm		mm			
11208A	115	40	22,23	2,30	10	112080004
11208A	115	60	22,23	2,30	10	112080006

	Ø	P	F	€		
	mm		mm			
11208B	125	40	22,23	2,75	10	112080104
11208B	125	60	22,23	2,75	10	112080106

11210A÷11210C

flap discs with zirconia abrasive cloth,
fibreglass backing pad, single flap construction

Cone-shaped
PREMIUM LINE
Ø 115 mm
EN 13743



	Ø	P	F	€		
	mm		mm			
11210A	115	40	22,23	2,30	10	112100004
11210A	115	60	22,23	2,30	10	112100006
11210A	115	80	22,23	2,30	10	112100008
11210A	115	120	22,23	2,30	10	112100012

	Ø	P	F	€		
	mm		mm			
11210B	125	40	22,23	2,75	10	112100104
11210B	125	60	22,23	2,75	10	112100106
11210B	125	80	22,23	2,75	10	112100108

	Ø	P	F	€		
	mm		mm			
11210C	180	40	22,23	6,10	10	112100204
11210C	180	60	22,23	6,10	10	112100206

11212A - 11212B

flap discs with zirconia abrasive cloth,
plastic backing pad, single flap construction

Flat
TOP LINE
Ø 115 mm
EN 13743

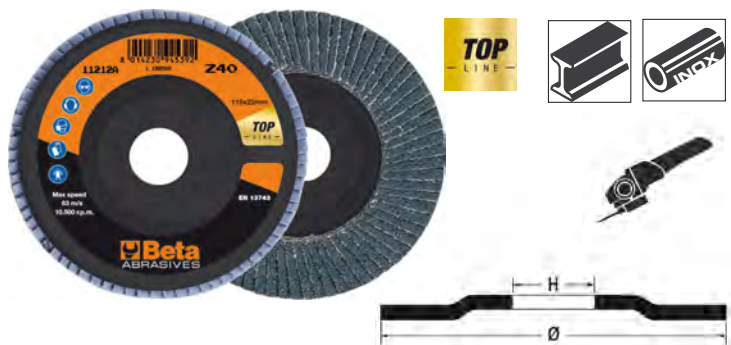

	Ø	P	F	€		
	mm		mm			
11212A	115	40	22,23	2,85	10	112120004
11212A	115	60	22,23	2,85	10	112120006
11212A	115	80	22,23	2,85	10	112120008
11212A	115	120	22,23	2,85	10	112120012

	Ø	P	F	€		
	mm		mm			
11212B	125	40	22,23	3,65	10	112120104
11212B	125	60	22,23	3,65	10	112120106
11212B	125	80	22,23	3,65	10	112120108

11214A÷11214C

flap discs with zirconia abrasive cloth,
plastic backing pad, double flap construction

Flat
TOP LINE
Ø 115 mm
EN 13743

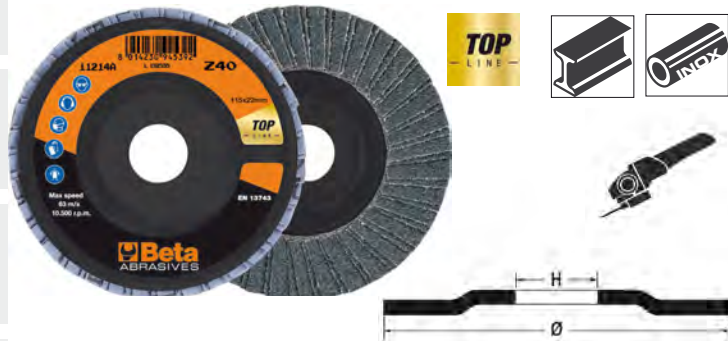

Ø	P	F	€	10	10
mm		mm			
11214A	115	40	22,23	2,85	10 112140004
11214A	115	60	22,23	2,85	10 112140006
11214A	115	80	22,23	2,85	10 112140008
11214A	115	120	22,23	2,85	10 112140012

Ø	P	F	€	10	10
mm		mm			
11214B	125	40	22,23	3,65	10 112140104
11214B	125	60	22,23	3,65	10 112140106
11214B	125	80	22,23	3,65	10 112140108

Ø	P	F	€	10	10
mm		mm			
11214C	180	40	22,23	6,80	10 112140204
11214C	180	60	22,23	6,80	10 112140206

11216A÷11216C

flap discs with zirconia abrasive cloth,
fibreglass backing pad, single flap construction

Flat
TOP LINE
Ø 115 mm
EN 13743



Ø	P	F	€	10	10
mm		mm			
11216A	115	40	22,23	2,85	10 112160004
11216A	115	60	22,23	2,85	10 112160006
11216A	115	80	22,23	2,85	10 112160008
11216A	115	120	22,23	2,85	10 112160012

Ø	P	F	€	10	10
mm		mm			
11216B	125	40	22,23	3,45	10 112160104
11216B	125	60	22,23	3,45	10 112160106
11216B	125	80	22,23	3,45	10 112160108

Ø	P	F	€	10	10
mm		mm			
11216C	180	40	22,23	6,80	10 112160204
11216C	180	60	22,23	6,80	10 112160206

11218A-11218B

flap discs with zirconia abrasive cloth,
fibreglass backing pad, double flap construction

Flat
TOP LINE
Ø 115 mm
EN 13743



Ø	P	F	€	10	10
mm		mm			
11218A	115	40	22,23	2,85	10 112180004
11218A	115	60	22,23	2,85	10 112180006

Ø	P	F	€	10	10
mm		mm			
11218B	125	40	22,23	3,45	10 112180104
11218B	125	60	22,23	3,45	10 112180106

11220A÷11220C

flap discs with zirconia abrasive cloth,
fibreglass backing pad, single flap construction

Cone-shaped
TOP LINE
Ø 115 mm
EN 13743



Ø	P	F	€	10	10
mm		mm			
11220A	115	40	22,23	2,85	10 112200004
11220A	115	60	22,23	2,85	10 112200006
11220A	115	80	22,23	2,85	10 112200008
11220A	115	120	22,23	2,85	10 112200012

Ø	P	F	€	10	10
mm		mm			
11220B	125	40	22,23	3,45	10 112200104
11220B	125	60	22,23	3,45	10 112200106
11220B	125	80	22,23	3,45	10 112200108

Ø	P	F	€	10	10
mm		mm			
11220C	180	40	22,23	6,80	10 112200204
11220C	180	60	22,23	6,80	10 112200206

11222

flap discs with zirconia abrasive cloth,
fibreglass backing pad, double flap construction

Cone-shaped
TOP LINE
Ø 115 mm
EN 13743

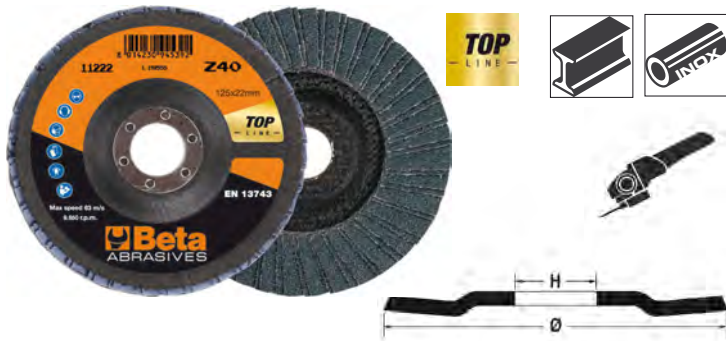

	Ø mm	P mm	F mm	€		
11222B	125	40	22,23	3,45	10	112220104
11222B	125	60	22,23	3,45	10	112220106
11222B	125	80	22,23	3,45	10	112220108

11230A-11230B

flap discs with corundum abrasive cloth,
plastic backing pad, single flap construction

Flat
PREMIUM LINE
Ø 115 mm
EN 13743



	Ø mm	P mm	F mm	€		
11230A	115	40	22,23	2,30	10	112300004
11230A	115	60	22,23	2,30	10	112300006
11230A	115	80	22,23	2,30	10	112300008
11230A	115	120	22,23	2,30	10	112300012
<hr/>						
	Ø mm	P mm	F mm	€		
11230B	125	40	22,23	2,90	10	112300104
11230B	125	60	22,23	2,90	10	112300106

Beta

11232A

flap discs with corundum abrasive cloth,
plastic backing pad, double flap construction

Flat
PREMIUM LINE
Ø 115 mm
EN 13743

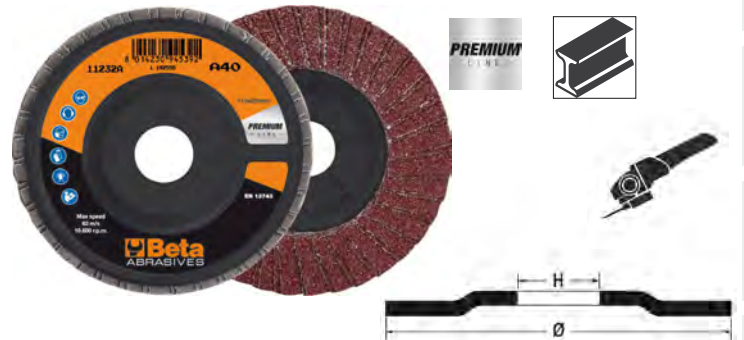

	Ø mm	P mm	F mm	€		
11232A	115	40	22,23	2,30	10	112320004
11232A	115	60	22,23	2,30	10	112320006
11232A	115	80	22,23	2,30	10	112320008
11232A	115	120	22,23	2,30	10	112320012

11234A-11234B

flap discs with corundum abrasive cloth,
fibreglass backing pad, single flap construction

Flat
TOP LINE
Ø 115 mm
EN 13743



	Ø mm	P mm	F mm	€		
11234A	115	40	22,23	2,60	10	112340004
11234A	115	60	22,23	2,60	10	112340006
11234A	115	80	22,23	2,60	10	112340008
11234A	115	120	22,23	2,60	10	112340012
<hr/>						
	Ø mm	P mm	F mm	€		
11234B	125	40	22,23	3,10	10	112340104
11234B	125	60	22,23	3,10	10	112340106

Beta

11240A-11240B

flap discs with ceramic-coated zirconia abrasive cloth, plastic backing pad and single flap construction

Flat
Ø 115 mm
EN 13743



	Ø mm	P mm	F mm	€		
11240A	115	40	22,23	3,90	10	112400004
11240A	115	60	22,23	3,90	10	112400006

	Ø mm	P mm	F mm	€		
11240B	125	40	22,23	4,60	10	112400104
11240B	125	60	22,23	4,60	10	112400106

11242A-11242B

flap discs with ceramic-coated zirconia abrasive cloth, fibreglass backing pad and single flap construction

Flat
Ø 115 mm
EN 13743

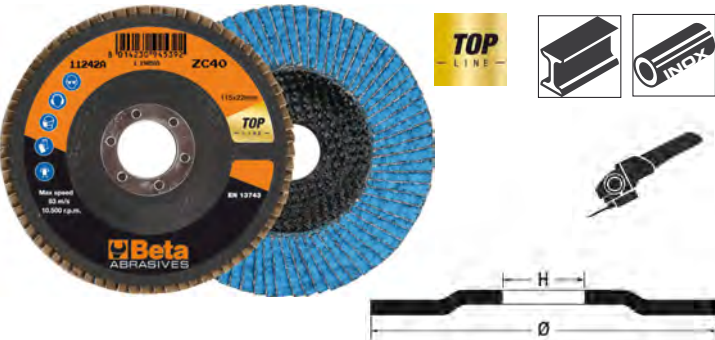

	Ø mm	P mm	F mm	€		
11242A	115	40	22,23	3,90	10	112420004
11242A	115	60	22,23	3,90	10	112420006

	Ø mm	P mm	F mm	€		
11242B	125	40	22,23	4,60	10	112420104
11242B	125	60	22,23	4,60	10	112420106

11246A

flap discs with ceramic-coated abrasive cloth, plastic backing pad and single flap construction

Flat
Ø 115 mm
EN 13743

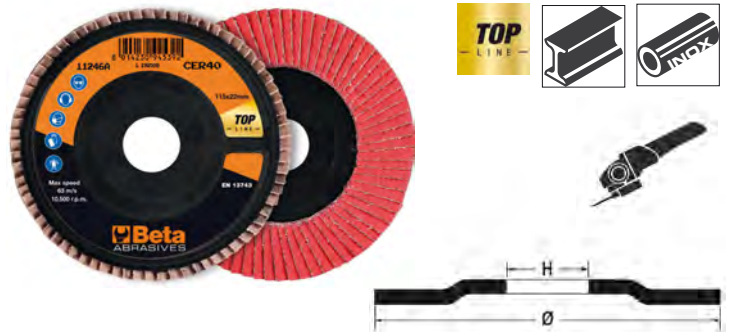

	Ø mm	P mm	F mm	€		
11246A	115	40	22,23	4,65	10	112460004
11246A	115	60	22,23	4,65	10	112460006

11248A-11248B

flap discs with ceramic-coated abrasive cloth, fibreglass backing pad and single flap construction

Flat
Ø 115 mm
EN 13743

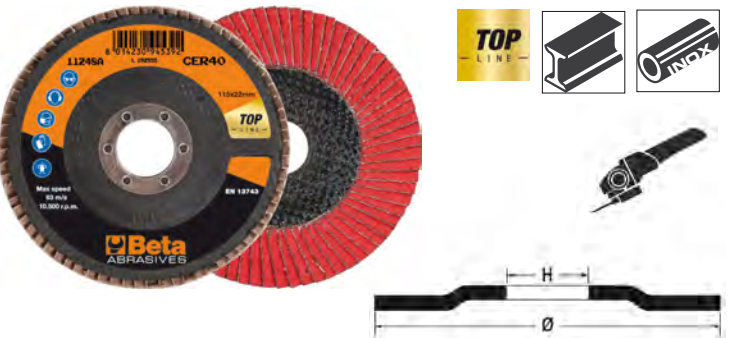

	Ø mm	P mm	F mm	€		
11248A	115	40	22,23	4,65	10	112480004
11248A	115	60	22,23	4,65	10	112480006

	Ø mm	P mm	F mm	€		
11248B	125	40	22,23	5,90	10	112480104
11248B	125	60	22,23	5,90	10	112480106

11259

felt flap discs, fibreglass backing pad, single flap construction

Flat



	Ø mm	F mm	€		
11259	115	22,23	8,00	10	112590115
11259	125	22,23	9,40	10	112590125

Beta

11260÷11268

shaft-mounted flap wheels,
corundum abrasive cloth flaps

shaft Ø 3 mm

EN 13743



	Ø mm	h mm	S mm	P	€		
11260	10	10	3	60	3,65	10	112600010
11260	15	15	3	60	3,00	10	112600015

	Ø mm	h mm	S mm	P	€		
11263	30	10	6	60	2,25	10	112630006
11263	30	15	6	60	2,25	10	112630016
11263	30	15	6	80	2,25	10	112630018
11263	30	20	6	40	2,35	10	112630024
11263	30	20	6	60	2,40	10	112630026
11263	30	20	6	80	2,40	10	112630028
11263	30	20	6	120	2,40	10	112630032

	Ø mm	h mm	S mm	P	€		
11264	40	15	6	60	2,50	10	112640006
11264	40	15	6	80	2,50	10	112640008
11264	40	15	6	120	2,50	10	112640012
11264	40	20	6	40	2,55	10	112640014
11264	40	20	6	60	2,60	10	112640016
11264	40	30	6	40	2,85	10	112640024
11264	40	30	6	60	2,85	10	112640026

	Ø mm	h mm	S mm	P	€		
11265	50	20	6	60	2,90	10	112650006
11265	50	20	6	80	2,90	10	112650008
11265	50	30	6	40	3,25	10	112650014
11265	50	30	6	60	3,25	10	112650016
11265	50	30	6	80	3,25	10	112650018
11265	50	30	6	120	3,45	10	112650022

	Ø mm	h mm	S mm	P	€		
11266	60	20	6	40	3,35	10	112660004
11266	60	20	6	60	3,35	10	112660006
11266	60	30	6	40	3,85	10	112660014
11266	60	30	6	60	3,85	10	112660016
11266	60	30	6	80	3,85	10	112660018
11266	60	30	6	120	4,10	10	112660022
11266	60	40	6	60	4,40	10	112660026
11266	60	40	6	80	4,40	10	112660028

	Ø mm	h mm	S mm	P	€		
11268	80	30	6	60	5,10	10	112680006
11268	80	30	6	80	5,10	10	112680008

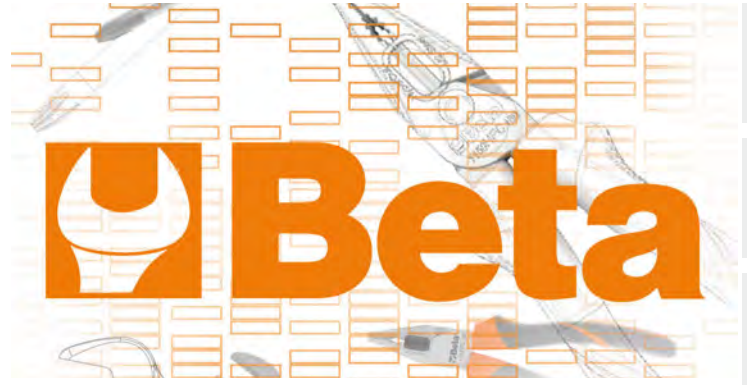

11271A÷11271C

abrasive non-woven wheels, shaft-mounted,
corundum synthetic fibre fabric

Ø 40 mm

shaft Ø 6 mm



	Ø mm	h mm	S mm	P	€		
11271A	40	20	6	C	5,10	10	112710001
11271A	40	20	6	M	5,10	10	112710002
11271A	40	20	6	F	5,10	10	112710003
11271A	40	20	6	VF	5,10	10	112710004

	Ø mm	h mm	S mm	P	€		
11271B	60	30	6	C	5,60	10	112710011
11271B	60	30	6	M	5,60	10	112710012
11271B	60	30	6	F	5,60	10	112710013
11271B	60	30	6	VF	5,60	10	112710014

	Ø mm	h mm	S mm	P	€		
11271C	80	50	6	C	6,40	10	112710021
11271C	80	50	6	M	6,40	10	112710022
11271C	80	50	6	F	6,40	10	112710023
11271C	80	50	6	VF	6,40	10	112710024

11276A÷11276C

flap/non-woven wheels, shaft-mounted,
flaps made of abrasive cloth alternating with corundum synthetic fibre
fabric

Ø 40 mm

shaft Ø 6 mm



	Ø mm	h mm	S mm	P	€		
11276A	40	20	6	M/60	5,70	10	112760006
11276A	40	20	6	M/80	5,70	10	112760008
11276A	40	20	6	M/120	5,70	10	112760012

	Ø mm	h mm	S mm	P	€		
11276B	60	30	6	M/60	6,70	10	112760016
11276B	60	30	6	M/80	6,70	10	112760018
11276B	60	30	6	M/120	6,70	10	112760022

	Ø mm	h mm	S mm	P	€		
11276C	80	50	6	M/60	8,15	10	112760036
11276C	80	50	6	M/80	8,15	10	112760038
11276C	80	50	6	M/120	8,15	10	112760042

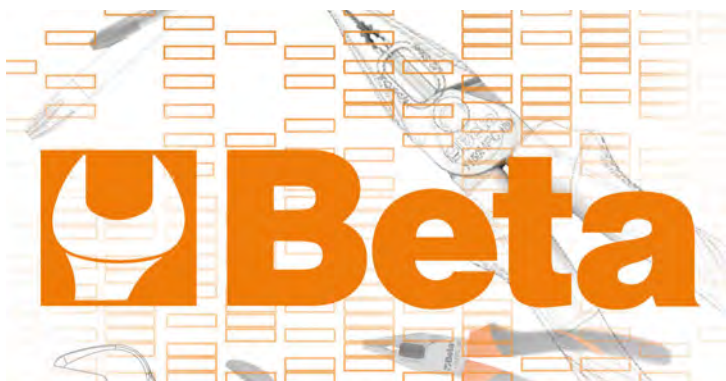

11300A÷11300G

flap wheels with corundum cloth, with bores

Ø 165 x 30 mm

EN 13743

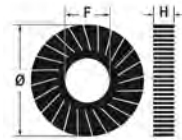

	Ø mm	H mm	P	F mm	€	🔧	📄
11300A	165	30	40	54	21,00	3	113000004
11300A	165	30	60	54	23,00	3	113000006
11300A	165	30	80	54	23,00	3	113000008
11300A	165	30	120	54	24,00	3	113000012
11300A	165	30	180	54	25,50	3	113000018
11300A	165	30	220	54	27,00	3	113000022
<hr/>							
11300B	165	50	40	54	28,50	2	113000104
11300B	165	50	60	54	30,00	2	113000106
11300B	165	50	80	54	31,00	2	113000108
11300B	165	50	120	54	34,50	2	113000112
11300B	165	50	180	54	38,00	2	113000118
11300B	165	50	220	54	39,50	2	113000122
<hr/>							
11300C	200	30	40	54	24,50	3	113000204
11300C	200	30	60	54	26,00	3	113000206
11300C	200	30	80	54	29,00	3	113000208
11300C	200	30	120	54	30,50	3	113000212
11300C	200	30	180	54	33,00	3	113000218
<hr/>							
11300D	200	50	40	54	35,00	2	113000304
11300D	200	50	60	54	38,00	2	113000306
11300D	200	50	80	54	40,00	2	113000308
11300D	200	50	120	54	43,00	2	113000312
11300D	200	50	180	54	48,00	2	113000318
11300D	200	50	220	54	51,00	2	113000322
<hr/>							
11300E	250	30	40	100	43,00	3	113000404
11300E	250	30	60	100	45,50	3	113000406
11300E	250	30	80	100	47,50	3	113000408
11300E	250	30	120	100	50,00	3	113000412
<hr/>							
11300F	250	50	40	100	63,00	2	113000504
11300F	250	50	60	100	67,50	2	113000506
11300F	250	50	80	100	69,00	2	113000508
11300F	250	50	120	100	72,00	2	113000512
11300F	250	50	180	100	80,50	2	113000518
11300F	250	50	220	100	91,00	2	113000522
<hr/>							
11300G	300	50	40	100	88,00	2	113000604
11300G	300	50	60	100	91,00	2	113000606
11300G	300	50	80	100	94,50	2	113000608

11320

abrasive non-woven wheels with bores,
corundum synthetic fibre fabric

Ø 200 x 50 mm



	Ø mm	H mm	P	F mm	€	🔧	📄
11320	200	50	C	76,2	25,50	2	113200006
11320	200	50	M	76,2	25,50	2	113200008
11320	200	50	F	76,2	25,50	2	113200012
11320	200	50	VF	76,2	25,50	2	113200024

11411

flap wheels with corundum cloth for satinizing machines

Ø 100 x 100 mm

EN 13743

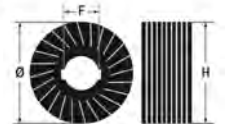

	Ø mm	H mm	P	F mm	€	🔧	📄
11411	100	100	40	19,1	22,50	2	114110004
11411	100	100	60	19,1	23,50	2	114110006
11411	100	100	80	19,1	24,50	2	114110008
11411	100	100	120	19,1	25,50	2	114110012
11411	100	100	240	19,1	26,50	2	114110024

11415B

non-woven flaps with
corundum synthetic fibres for satinizing machines

Ø 100 x 100 mm

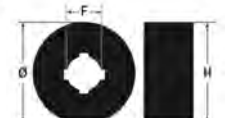

	Ø mm	H mm	P	F mm	€	🔧	📄
11415B	100	100	C	19,1	17,70	2	114150106
11415B	100	100	M	19,1	17,70	2	114150108
11415B	100	100	F	19,1	17,70	2	114150112
11415B	100	100	VF	19,1	17,70	2	114150124

11420B

flap/non-woven wheels for satinizing machines,
abrasive cloth alternating with corundum synthetic fibres

Ø 100 x 100 mm

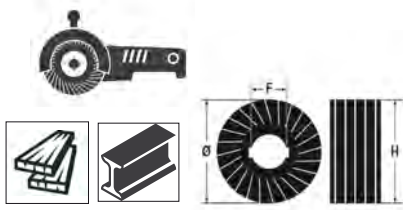

	Ø mm	H mm	P	F mm	€		
11420B	100	100	C/60	19,1	20,80	2	114200106
11420B	100	100	M/80	19,1	20,80	2	114200108
11420B	100	100	F/120	19,1	20,80	2	114200112
11420B	100	100	VF/240	19,1	20,80	2	114200124

11431

non-woven radial discs,
corundum synthetic fibres

Ø 115 mm

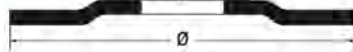

	Ø mm	P	F mm	€		
11431	115	C	22,23	12,00	4	114310006
11431	115	M	22,23	12,00	4	114310008
11431	115	F	22,23	12,00	4	114310012
11431	115	VF	22,23	12,00	4	114310024

11435

flap/non-woven radial discs,
abrasive cloth alternating with corundum synthetic fibres

Ø 115 mm

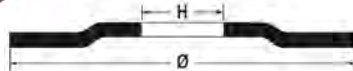

	Ø mm	P	F mm	€		
11435	115	M/80	22,23	15,10	4	114350008
11435	115	M/120	22,23	15,10	4	114350012
11435	115	F/150	22,23	15,10	4	114350015
11435	115	F/180	22,23	15,10	4	114350018

11440A÷11440C

fibre discs with zirconia cloth

Ø 115 mm

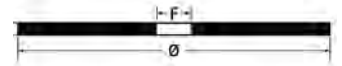

	Ø mm	P	F mm	€		
11440A	115	24	22	0,97	25	114400024
11440A	115	36	22	0,97	25	114400036
11440A	115	60	22	0,86	25	114400060
11440A	115	120	22	0,86	25	114400120

	Ø mm	P	F mm	€		
11440B	125	24	22	1,09	25	114400224
11440B	125	36	22	1,09	25	114400236
11440B	125	60	22	1,02	25	114400260
11440B	125	120	22	1,02	25	114400320

	Ø mm	P	F mm	€		
11440C	180	24	22	1,72	25	114400424
11440C	180	36	22	1,72	25	114400436
11440C	180	60	22	1,66	25	114400460
11440C	180	120	22	1,66	25	114400520

11450A÷11450C

fibre discs with corundum cloth

Ø 115 mm



	Ø mm	P	F mm	€		
11450A	115	24	22	0,75	25	114500024
11450A	115	36	22	0,75	25	114500036
11450A	115	60	22	0,69	25	114500060
11450A	115	120	22	0,69	25	114500120

	Ø mm	P	F mm	€		
11450B	125	24	22	0,86	25	114500224
11450B	125	36	22	0,86	25	114500236
11450B	125	60	22	0,80	25	114500260
11450B	125	120	22	0,80	25	114500320

	Ø mm	P	F mm	€		
11450C	180	24	22	1,38	25	114500424
11450C	180	36	22	1,38	25	114500436
11450C	180	60	22	1,32	25	114500460
11450C	180	120	22	1,32	25	114500520

11488PF

fixing pads for fibre discs with ring nut M14



	Ø mm	€		
11488P	115	6,30	1	114880115
11488P	125	7,00	1	114880125
11488P	180	10,80	1	114880180

11491-11493-11495

anti-waste rolls made of corundum abrasive cloth

h 38 mm x 50 m



	H mm	L m	P	€		
11491	38	50	40	38,00	1	114910004
11491	38	50	60	37,00	1	114910006
11491	38	50	80	36,00	1	114910008
11491	38	50	100	36,00	1	114910010
11491	38	50	120	36,00	1	114910012
11491	38	50	150	36,00	1	114910015
11491	38	50	180	36,00	1	114910018
11491	38	50	220	36,00	1	114910022
11491	38	50	240	36,00	1	114910024
11491	38	50	320	36,00	1	114910032
11491	38	50	400	36,00	1	114910040

	H mm	L m	P	€		
11493	50	50	40	58,50	1	114930004
11493	50	50	60	56,00	1	114930006
11493	50	50	80	54,00	1	114930008
11493	50	50	100	52,00	1	114930010
11493	50	50	120	52,00	1	114930012
11493	50	50	150	52,00	1	114930015
11493	50	50	180	52,00	1	114930018
11493	50	50	220	52,00	1	114930022
11493	50	50	240	52,00	1	114930024
11493	50	50	320	52,00	1	114930032
11493	50	50	400	52,00	1	114930040

	H mm	L m	P	€		
11495	120	25	40	73,00	1	114950004
11495	120	25	60	71,00	1	114950006
11495	120	25	80	69,00	1	114950008
11495	120	25	100	67,50	1	114950010
11495	120	25	120	67,50	1	114950012
11495	120	25	180	67,50	1	114950018
11495	120	25	240	67,50	1	114950024
11495	120	25	400	67,50	1	114950040

11498

non-woven anti-waste roll
with corundum synthetic fibres
h 100 mm x 10 m



	H mm	L m	P	€		
11498	100	10	M	30,50	1	114980008
11498	100	10	F	23,90	1	114980012
11498	100	10	VF	23,90	1	114980015
* 11498	100	10	UF	27,00	1	114980018



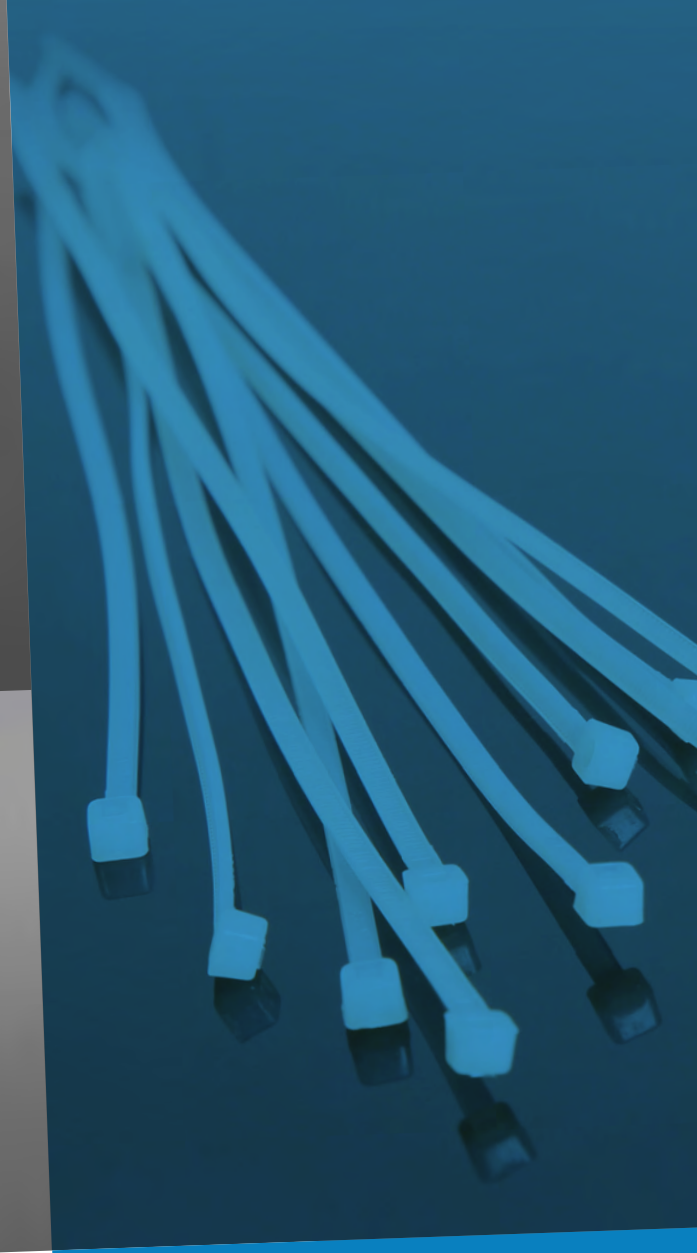

PRODUCTS UNDER THE BRAND NAME BM: CABLE TIES, TERMINAL BLOCKS, ELECTRICAL TAPES

BM Group has been designing, manufacturing and distributing connecting parts and electrical installation products since 1958. Quality, safety and reliability have always been BM's key values. Combined with a passion for excellence, these values have allowed the company to develop – step by step – into a benchmark for the electrical material market.

In 2018 BM Group was taken over by Beta Utensili. This section comprises an accurate selection of products under the brand name BM, supplementing Beta's product range.

CERTIFIED QUALITY

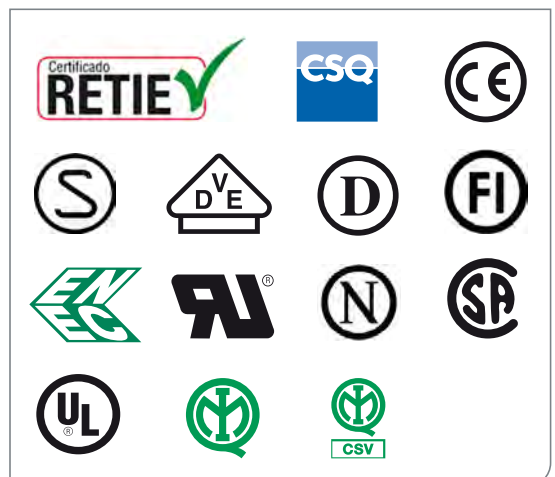

1610-B

pre-insulated ring terminals



D mm	mm²	L mm	€	100	BM00119
4	0,25-1,5	20,6	7,10	100	BM00119
5	0,25-1,5	21,8	7,05	100	BM00125
5	1,5-2,5	22,4	7,20	100	BM00225
6	1,5-2,5	26	8,05	100	BM00231
8	1,5-2,5	29,8	9,60	100	BM00237
6	4-6	29,1	12,60	50	BM00331
8	4-6	34,5	15,50	50	BM00337

- Please indicate number of terminals, and not of packages, in your order
- Stated prices are for 100 pieces

1614-P

pre-insulated ferrule terminals

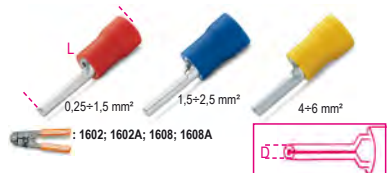

D mm	mm²	L mm	€	100	BM00151
1,8	0,25-1,5	20	7,10	100	BM00151
1,8	1,5-2,5	20	7,50	100	BM00251
2,6	4-6	28	12,40	50	BM00350

- Please indicate number of terminals, and not of packages, in your order
- Stated prices are for 100 pieces

1616-SM

pre-insulated male pin terminals

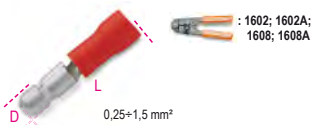

D mm	mm²	L mm	€	100	BM00130
4	0,25-1,5	21	14,00	100	BM00130

- Please indicate number of terminals, and not of packages, in your order
- Stated prices are for 100 pieces

1618-SF

pre-insulated female pin terminals



D mm	mm²	L mm	€	100	BM00140
4	0,25-1,5	23,5	16,30	100	BM00140

- Please indicate number of terminals, and not of packages, in your order
- Stated prices are for 100 pieces

1620-M

pre-insulated quick male terminals

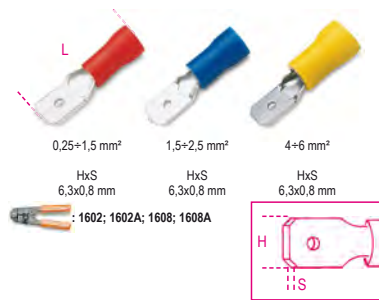

HxS mm	mm²	L mm	€	100	BM00180
6,3x0,8	0,25-1,5	21	13,50	100	BM00180
6,3x0,8	1,5-2,5	21	14,00	100	BM00280
6,3x0,8	4-6	24,5	15,40	50	BM00380

- Please indicate number of terminals, and not of packages, in your order
- Stated prices are for 100 pieces

1622-F

pre-insulated quick female terminals

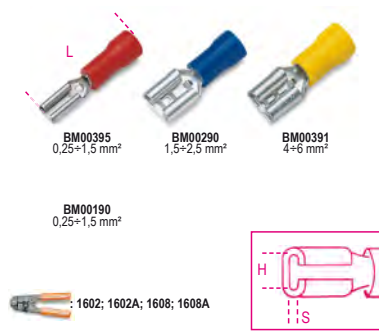

HxS mm	mm²	L mm	€	100	BM00190
6,3x0,8	0,25-1,5	20,7	13,70	100	BM00190
2,8x0,5	0,25-1,5	18,5	11,60	100	BM00395
6,3x0,8	1,5-2,5	20,7	14,00	100	BM00290
6,3x0,8	4-6	24,5	19,90	50	BM00391

- Please indicate number of terminals, and not of packages, in your order
- Stated prices are for 100 pieces

1624-FI

insulated quick female terminals

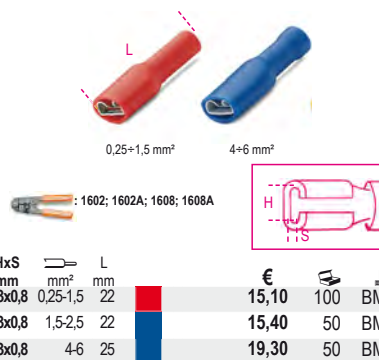

HxS mm	mm²	L mm	€	100	BM00191
6,3x0,8	0,25-1,5	22	15,10	100	BM00191
6,3x0,8	1,5-2,5	22	15,40	50	BM00291
6,3x0,8	4-6	25	19,30	50	BM00392

- Please indicate number of terminals, and not of packages, in your order
- Stated prices are for 100 pieces

1628-C

pre-insulated cable connectors

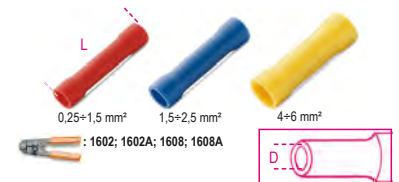

D mm	mm²	L mm	€	100	BM00160
1,8	0,25-1,5	25	11,40	100	BM00160
2,5	1,5-2,5	26,5	13,50	100	BM00260
3,7	4-6	27	18,70	50	BM00360

- Please indicate number of terminals, and not of packages, in your order
- Stated prices are for 100 pieces

1630-CR

quick connectors



mm²	L mm	€	500	BM00110
0,25-1	20	11,80	500	BM00110
1,25-2,5	20	11,40	500	BM00210

- Please indicate number of terminals, and not of packages, in your order
- Stated prices are for 100 pieces

1632-TS

single tube terminals



mm²	L mm	€	500	BM00601
0,5	14	1,42	500	BM00601
0,75	14	1,42	500	BM00602
1	14	1,42	500	BM00603
1,5	14	1,42	500	BM00604
2,5	14	1,85	250	BM00506
4	17	2,93	200	BM00508
6	20	4,75	100	BM00610

- Please indicate number of terminals, and not of packages, in your order
- Stated prices are for 100 pieces

1634-TD

dual tube terminals



mm²	L mm	€	200	BM00651
2x0,5	15	4,70	200	BM00651
2x0,75	15	3,60	200	BM00652
2x1	15	3,60	200	BM00654
2x1,5	16	3,85	200	BM00656
2x2,5	18,5	4,40	100	BM00558
2x4	23	13,20	100	BM00560
2x6	26	17,10	50	BM00661

- Please indicate number of terminals, and not of packages, in your order
- Stated prices are for 100 pieces



1635-S

closed end connector terminals, for free connections

Insulating housing: transparent polycarbonate UL94 V0

Conductive body: brass

Captive screw: galvanized steel

Self-extinguishing: EN60695-2-10 a 850°C, EN 60335-1:2002

+A2:2006, EN60695-2-11

Working temperature: max. 85 °C

Degree of protection: IP20

Reference standards: EN60998-1; EN60998-2-1:2004



mm²	L	L1	S	mm²	N	€		
1.5	15	7.5	14.5	1.5	2	1,05	10	BM991
				0.75	2+4			
2.5	17.5	9	18.2	2.5	2	1,08	10	BM992
				1.5	2+3			
				1	2+4			
4	21	10.3	20	4	2	1,44	10	BM9924
				2	2+3			
				1.5	2+4			
6	22.5	11.8	23	6	2	1,68	10	BM993
				4	2+3			
				2.5	2+4			
10	26	14.7	26	10	2	2,85	10	BM994
				6	2+3			
				4	2+4			
16	31.8	18.8	32.2	16	2	6,80	10	BM995
				10	2+3			
				6	2+4			

1635-S



mm²	L	L1	S	mm²	N	€		
25	36.3	22.5	41.9	25	2	3,25	25	BM9960
				16	2+3			
				10	2+4			
35	43.5	26.1	49.4	35	2	4,15	25	BM9961
				25	2+3			
				16	2+4			



1748-BV2

nylon cable ties, natural colour

Material: polyamide PA 6.6

Self-extinguishing class: UL 94-V2

Working temperature: -40 °C ÷ +85 °C

Minimum installation temperature: -10 °C

Resistance to chemicals: Good resistance to bases, oils, greases, chloride solvents. Limited resistance to acids. Not resistant to phenols

Reference standards: EN 62275:2015-02

Classification: type 1 (EN); type 21 (UL)



A	L	Ø MAX	F MAX	€		
2.5	80	14	80	1,02	100	BMB0824
2.5	100	20.5	80	0,96	100	BMB1025
2.5	120	27	80	1,68	100	BMB1225
2.5	160	40	80	2,25	100	BMB1625
2.5	200	52.5	80	2,49	100	BMB2025
3.6	140	33	180	2,53	100	BMB1436
3.6	200	52.5	180	3,50	100	BMB2036
3.6	300	106	180	4,90	100	BMB2936
3.6	370	105	180	7,80	100	BMB3736
4.6	120	24	220	3,40	100	BMB1248
4.6	160	36	220	3,65	100	BMB1648
4.8	188	46	220	4,35	100	BMB1948
4.8	200	50	220	4,30	100	BMB2048
4.8	250	65	220	6,25	100	BMB2548
4.8	300	81	220	6,35	100	BMB3048
4.8	370	103.5	220	8,10	100	BMB3748
4.8	390	110	220	11,00	100	BMB3948
4.8	430	122.5	220	14,20	100	BMB4348
4.8	530	160	220	23,60	100	BMB5348
7.6	150	24	550	11,70	100	BMB1576
7.6	200	51	550	12,10	100	BMB2076
7.6	300	83	550	13,50	100	BMB2976
7.6	370	103.5	550	16,40	100	BMB3776
7.6	450	130.5	550	27,50	100	BMB4576
7.6	540	159	550	35,50	100	BMB5476
7.6	750	226	550	57,00	100	BMB7576
8.8	550	163.5	800	33,50	100	BMB5390
8.8	710	195	800	47,50	100	BMB7190
8.8	780	235.5	800	53,00	100	BMB7890
9.0	430	130.5	800	28,00	100	BMB4390
9.0	810	245	800	63,00	100	BMB8190
9.0	1020	295	800	86,50	100	BMB1090
9.0	1220	375.5	800	112,50	100	BMB1290
9.0	1530	460	800	154,00	100	BMB1590

- Please indicate number of cable ties, and not of packages, in your order
- Stated prices are for 100 pieces

1748N

nylon cable ties, black

UV resistant

Material: polyamide PA 6.6 + carbon black

Self-extinguishing class: UL 94-V2

Working temperature: -40 °C ÷ +85 °C

Minimum installation temperature: -10 °C

Resistance to chemicals: Good resistance to bases, oils, greases, chloride solvents. Limited resistance to acids. Not resistant to phenols

Reference standards: EN 62275:2015-02

Classification: type 1 (EN)



A	L	F MAX	€			
2.5	80	14	80	1,02	100	BMN0824
2.5	100	20.5	80	0,96	100	BMN1025
2.5	120	27	80	1,71	100	BMN1225
2.5	160	40	80	2,25	100	BMN1625
2.5	200	52.5	80	2,49	100	BMN2025

A	L	F MAX	€			
3.6	140	33	180	2,53	100	BMN1436
3.6	200	52.5	180	3,50	100	BMN2036
3.6	300	106	180	4,90	100	BMN2936
3.6	370	105	180	7,95	100	BMN3736
4.6	120	24	220	3,40	100	BMN1248
4.6	160	36	220	3,70	100	BMN1648
4.8	188	46	220	4,45	100	BMN1948
4.8	200	50	220	4,30	100	BMN2048
4.8	250	65	220	6,25	100	BMN2548
4.8	300	81	220	6,35	100	BMN3048
4.8	370	103.5	220	8,10	100	BMN3748
4.8	390	110	220	11,00	100	BMN3948
4.8	430	122.5	220	14,20	100	BMN4348
4.8	530	160	220	23,60	100	BMN5348
7.6	150	24	550	11,70	100	BMN1576
7.6	200	51	550	12,10	100	BMN2076
7.6	300	83	550	13,50	100	BMN2976
7.6	370	103.5	550	16,10	100	BMN3776
7.6	450	130.5	550	27,50	100	BMN4576
7.6	540	159	550	35,50	100	BMN5476
7.6	750	226	550	57,00	100	BMN7576
8.8	550	163	800	33,50	100	BMN5390
8.8	710	195	800	47,00	100	BMN7190
8.8	780	235.5	800	53,00	100	BMN7890
9.0	430	130	800	28,00	100	BMN4390
9.0	810	245	800	62,50	100	BMN8190
9.0	1020	295	800	87,00	100	BMN1090
9.0	1220	375.5	800	112,50	100	BMN1290
9.0	1530	460	800	154,00	100	BMN1590

- Please indicate number of cable ties, and not of packages, in your order
- Stated prices are for 100 pieces

1748-UL

nylon cable ties, for heavy loads, black

UV and IMPACT resistant

Material: polyamide PA 6.6 + carbon black

Self-extinguishing class: UL 94-V2

Working temperature: -40 °C ÷ +85 °C

Minimum installation temperature: -10 °C

Resistance to chemicals: Good resistance to bases, oils, greases, chloride solvents. Limited resistance to acids. Not resistant to phenols

Reference standards: EN 62275:2015-02

Classification: type 1 (EN); type 21 (UL)

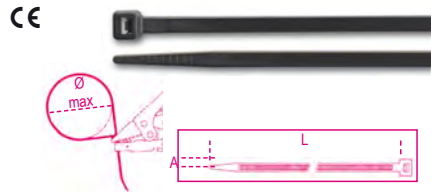

A	L	Ø MAX	F MAX	€		
12.4	230	57	1200	34,50	100	BMN2412
12.4	480	136.5	1200	60,00	100	BMN4912
12.4	730	216.1	1200	83,00	100	BMN7412
12.4	880	263.9	1200	99,50	100	BMN8912
12.4	1000	305	1200	118,50	100	BMN1012

- Please indicate number of cable ties, and not of packages, in your order
- Stated prices are for 100 pieces



1748-N2D

nylon cable ties,
black,
UV resistant

Material: polyamide PA 6.6 + carbon black
Self-extinguishing class: UL 94-V2
Working temperature: -40 °C ÷ +85 °C
Minimum installation temperature: -10 °C
Resistance to chemicals: Good resistance to bases, oils, greases, chloride solvents. Limited resistance to acids. Not resistant to phenols
Reference standards: EN 62275:2015-02
Classification: type 1 (EN)

CE



A	L	Ø MAX	F MAX	€	📦	🖨️
mm	mm	mm	N			
9.0	180	40	400	18,10	100	BMN1890
9.0	265	62	540	28,00	100	BMN2690
9.0	360	93	540	34,00	100	BMN3690

- Please indicate number of cable ties, and not of packages, in your order
- Stated prices are for 100 pieces

1748-BV0

self-extinguishing nylon cable ties,
white

Material: polyamide PA 6.6
Self-extinguishing class: UL 94-V0
Working temperature: -40 °C ÷ +85 °C
Minimum installation temperature: -10 °C
Resistance to chemicals: Good resistance to bases, oils, greases, chloride solvents. Limited resistance to acids. Not resistant to phenols
Reference standards: EN 62275:2015-02
Classification: type 1 (EN)

CE

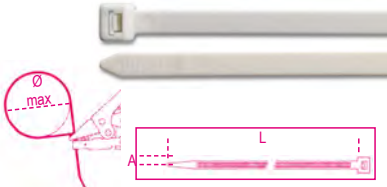

A	L	Ø MAX	F MAX	€	📦	🖨️
mm	mm	mm	N			
2.5	100	20.5	80	1,48	100	BMB1025V0
3.6	150	36.0	180	3,60	100	BMB1536V0
3.6	200	52.5	180	5,20	100	BMB2036V0
4.8	200	49.5	230	5,65	100	BMB2048V0
4.8	300	81.0	230	8,25	100	BMB3048V0
4.8	380	106.7	230	11,80	100	BMB3848V0
7.6	380	106.7	540	20,70	100	BMB3876V0

- Please indicate number of cable ties, and not of packages, in your order
- Stated prices are for 100 pieces

1748-BX

nylon cable ties,
blue,
detectable by metal detectors

Material: polyamide PA 6.6 + metal powder
Self-extinguishing class: UL 94-V2
Working temperature: -40°C ÷ +85°C
Minimum installation temperature: -10 °C
Resistance to chemicals: Good resistance to bases, oils, greases, chloride solvents. Limited resistance to acids. Not resistant to phenols
Reference standards: EN 62275:2015-02
Classification: type 1 (EN)

CE

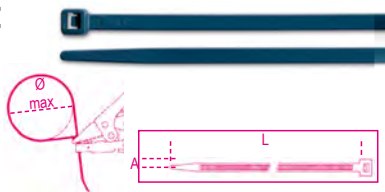

A	L	Ø MAX	F MAX	€	📦	🖨️
mm	mm	mm	N			
2.5	100	20.5	80	1,79	100	BMBX1025
3.6	150	36.0	180	4,70	100	BMBX1536
3.6	200	52.5	180	6,35	100	BMBX2036
4.8	200	49.5	230	7,75	100	BMBX2048
4.8	300	81.0	230	11,20	100	BMBX3048
4.8	380	106.7	230	15,20	100	BMBX3848
7.6	380	106.7	540	27,50	100	BMBX3876

- Please indicate number of cable ties, and not of packages, in your order
- Stated prices are for 100 pieces

1748-BL

steel tooth nylon cable ties,
natural colour

Material: polyamide PA 6.6 + steel
Self-extinguishing class: UL 94-V2
Working temperature: -40 °C ÷ +85 °C
Minimum installation temperature: -10 °C
Resistance to chemicals: Good resistance to bases, oils, greases, chloride solvents. Limited resistance to acids. Not resistant to phenols
Reference standards: EN 62275:2015-02
Classification: type 1 (EN)

CE

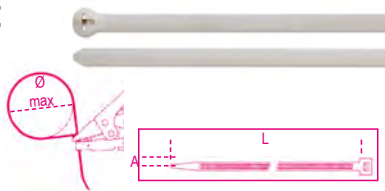

A	L	Ø MAX	F MAX	€	📦	🖨️
mm	mm	mm	N			
2.5	100	20.5	180	3,55	100	BMBL1025
3.6	140	33.0	250	8,00	100	BMBL1436
2.5	200	52.5	180	4,65	100	BMBL2025
4.8	200	49.5	360	11,10	100	BMBL2048
4.8	300	81.0	360	14,30	100	BMBL3048
4.8	370	103.5	360	17,20	100	BMBL3748
7.6	370	103.5	780	32,50	100	BMBL3776

- Please indicate number of cable ties, and not of packages, in your order
- Stated prices are for 100 pieces

1748-NL

steel tooth nylon cable ties,
black,
UV resistant

Material: polyamide PA 6.6 + steel + carbon black
Self-extinguishing class: UL 94-V2
Working temperature: -40 °C ÷ +85 °C
Minimum installation temperature: -10 °C
Resistance to chemicals: Good resistance to bases, oils, greases, chloride solvents. Limited resistance to acids. Not resistant to phenols
Reference standards: EN 62275:2015-02
Classification: type 1 (EN)

CE



A	L	Ø MAX	F MAX	€	📦	🖨️
mm	mm	mm	N			
2.5	100	20.5	180	3,55	100	BMNL1025
3.6	140	33.0	250	8,00	100	BMNL1436
2.5	200	52.5	180	4,65	100	BMNL2025
4.8	200	49.5	360	11,10	100	BMNL2048
4.8	300	81.0	360	14,30	100	BMNL3048
4.8	370	103.5	360	17,20	100	BMNL3748
7.6	370	103.5	780	32,00	100	BMNL3776

- Please indicate number of cable ties, and not of packages, in your order
- Stated prices are for 100 pieces

1748-BR

reusable nylon cable ties,
natural colour

Material: polyamide PA 6.6
Self-extinguishing class: UL 94-V2
Working temperature: -40 °C ÷ +85 °C
Minimum installation temperature: -10 °C
Resistance to chemicals: Good resistance to bases, oils, greases, chloride solvents. Limited resistance to acids. Not resistant to phenols
Reference standards: EN 62275:2015-02
Classification: type 1 (EN); type 21 (UL)

CE

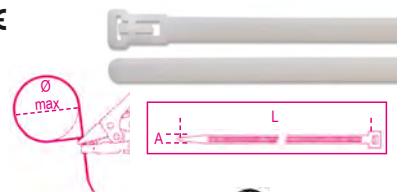

UL FILE N° E223175

A	L	Ø MAX	F MAX	€	📦	🖨️
mm	mm	mm	N			
7.6	150	40	230	12,30	100	BMBR1576
7.6	200	55	230	13,20	100	BMBR2076
7.6	300	82	230	22,30	100	BMBR3076

- Please indicate number of cable ties, and not of packages, in your order
- Stated prices are for 100 pieces

Beta

Beta

1748-BH

nylon cable ties with eyelets,
natural colour

Material: polyamide PA 6.6
Self-extinguishing class: UL 94-V2
Working temperature: -40 °C ÷ +85 °C
Minimum installation temperature: -10 °C
Resistance to chemicals: Good resistance to bases, oils, greases, chloride solvents. Limited resistance to acids. Not resistant to phenols
Reference standards: EN 62275:2015-02
Classification: type 1 (EN); type 21 (UL)

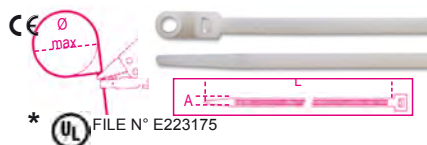

A	L	Ø MAX	F MAX	€	📦	🖨️
mm	mm	mm	N			
2.5	110	19.0	80	3,30	100	BMBH1125
* 4.8	200	49.8	230	8,10	100	BMBH2048
* 7.6	305	78.7	550	26,50	100	BMBH3076

- Please indicate number of cable ties, and not of packages, in your order
- Stated prices are for 100 pieces

1748-BP

insertion nylon cable ties,
natural colour

Material: polyamide PA 6.6
Self-extinguishing class: UL 94-V2
Working temperature: -40 °C ÷ +85 °C
Minimum installation temperature: -10 °C
Resistance to chemicals: Good resistance to bases, oils, greases, chloride solvents. Limited resistance to acids. Not resistant to phenols
Reference standards: EN 62275:2015-02
Classification: type 1 (EN); type 21 (UL)

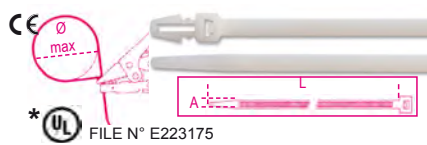

A	L	Ø MAX	F MAX	€	📦	🖨️
mm	mm	mm	N			
3.6	155	37.9	180	5,00	100	BMBP1536
* 4.8	200	50.8	230	8,65	100	BMBP2048

- Please indicate number of cable ties, and not of packages, in your order
- Stated prices are for 100 pieces

1748-BT

nylon cable ties with cross plates, 25x8mm,
natural colour

Material: polyamide PA 6.6
Self-extinguishing class: UL 94-V2
Working temperature: -40 °C ÷ +85 °C
Minimum installation temperature: -10 °C
Resistance to chemicals: Good resistance to bases, oils, greases, chloride solvents. Limited resistance to acids. Not resistant to phenols
Reference standards: EN 62275:2015-02
Classification: type 1 (EN); type 21 (UL)

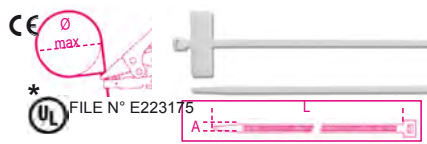

A	L	Ø MAX	F MAX	€	📦	🖨️
mm	mm	mm	N			
2.5	100	22.0	80	5,60	100	BMBT21025
2.5	200	53.5	80	8,80	100	BMBT22025

- Please indicate number of cable ties, and not of packages, in your order
- Stated prices are for 100 pieces

1748-BT2

nylon cable ties with lengthwise plates,
13x27mm,
natural colour

Material: polyamide PA 6.6
Self-extinguishing class: UL 94-V2
Working temperature: -40 °C ÷ +85 °C
Minimum installation temperature: -10 °C
Resistance to chemicals: Good resistance to bases, oils, greases, chloride solvents. Limited resistance to acids. Not resistant to phenols
Reference standards: EN 62275:2015-02
Classification: type 1 (EN)

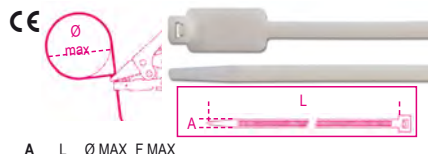

A	L	Ø MAX	F MAX	€	📦	🖨️
mm	mm	mm	N			
4.8	190	51	230	10,40	100	BMBT12248

- Please indicate number of cable ties, and not of packages, in your order
- Stated prices are for 100 pieces

1748-BT3

nylon cable ties with exterior plates, 20x9mm,
natural colour

Material: polyamide PA 6.6
Self-extinguishing class: UL 94-V2
Working temperature: -40 °C ÷ +85 °C
Minimum installation temperature: -10 °C
Resistance to chemicals: good Resistance to bases, oils, greases, chloride solvents. Limited resistance to acids. Not resistant to phenols
Reference standards: EN 62275:2015-02
Classification: type 1 (EN)

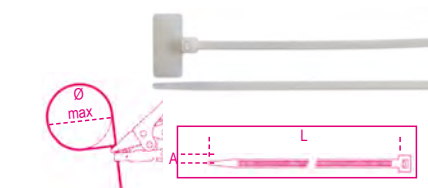

A	L	Ø MAX	F MAX	€	📦	🖨️
mm	mm	mm	N			
2.5	110	22	80	5,75	100	BMBT11125

- Please indicate number of cable ties, and not of packages, in your order
- Stated prices are for 100 pieces

1748-BA1

cable tie mounts

Material: polyamide PA 6.6
Self-extinguishing class: UL 94-V2
Working temperature: -40 °C ÷ +85 °C
Minimum installation temperature: -10 °C
Resistance to chemicals: Good resistance to bases, oils, greases, chloride solvents. Limited resistance to acids. Not resistant to phenols



SxDxH	Ø	F	€	📦	🖨️
mm	mm	mm			
15.2x9.4x6.8	3.3	3.6	7,75	100	BMB0905
22x16.2x10.8	5.2	9	17,60	100	BMB0906

- Please indicate number of cable ties, and not of packages, in your order
- Stated prices are for 100 pieces

1748-NA1

cable tie mounts

Material: polyamide PA 6.6
Self-extinguishing class: UL 94-V2
Working temperature: -40 °C ÷ +85 °C
Minimum installation temperature: -10 °C
Resistance to chemicals: Good resistance to bases, oils, greases, chloride solvents. Limited resistance to acids. Not resistant to phenols



SxDxH	Ø	F	€	📦	🖨️
mm	mm	mm			
15.2x9.4x6.8	3.3	3.6	8,05	100	BMN0905
22x16.2x10.8	5.2	9	14,30	100	BMN0906

- Please indicate number of cable ties, and not of packages, in your order
- Stated prices are for 100 pieces

1748-BA2

cable tie mounts - two-way

Material: polyamide PA 6.6
Self-extinguishing class: UL 94-V2
Working temperature: -40 °C ÷ +85 °C
Minimum installation temperature: -10 °C
Resistance to chemicals: Good resistance to bases, oils, greases, chloride solvents. Limited resistance to acids. Not resistant to phenols

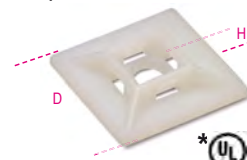

SxDxH	F	€	📦	🖨️
mm	mm			
19x19x5.4	3.6	9,75	100	BMB0901
* 28x28x7	4.8	13,40	100	BMB0902
* 28x28x5.8	4.8	12,30	100	BMB0903

1748-NA2

cable tie mounts - two-way,
UV resistant

Material: polyamide PA 6.6
Self-extinguishing class: UL 94-V2
Working temperature: -40 °C ÷ +85 °C
Minimum installation temperature: -10 °C
Resistance to chemicals: Good resistance to bases, oils, greases, chloride solvents. Limited resistance to acids. Not resistant to phenols



SxDxH	F	€	📦	🖨️
mm	mm			
19x19x5.4	3.6	9,75	100	BMN0901
* 28x28x7	4.8	13,40	100	BMN0902
* 28x28x5.8	4.8	12,20	100	BMN0903

- Please indicate number of cable ties, and not of packages, in your order
- Stated prices are for 100 pieces

1748-S

self-locking stainless steel cable ties

Material: stainless steel AISI 304
 Locking device: roller ball type
 Self-extinguishing class: non-flammable
 Plenum rating: AH-1
 UV resistance: excellent
 Working temperature: -60 °C ÷ +300 °C
 Minimum installation temperature: -60 °C
 Resistance to chemicals: excellent
 Reference standards: EN 62275:2015-02
 Classification: type 2 (EN); type 2 (UL)

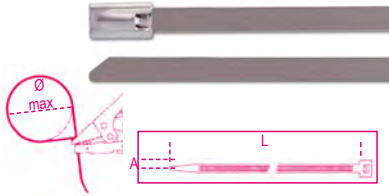

A	L	ØMAX	Trazione	€		
mm	mm	mm	N			
4.6	125	38	890	59,00	100	BMS1345
4.6	200	61	890	61,50	100	BMS2045
7.9	200	61	1500	65,00	100	BMS2079
4.6	290	90	890	66,00	100	BMS3045
7.9	300	90	1500	75,00	100	BMS3079
4.6	360	112	890	72,00	100	BMS3745
7.9	360	112	1500	82,00	100	BMS3779
7.9	520	163	1500	97,00	100	BMS5079
4.6	520	163	890	72,00	100	BMS5245
4.6	680	214	890	76,50	100	BMS6845
7.9	680	214	1500	110,50	100	BMS6879
4.6	840	265	890	80,00	100	BMS8445
7.9	840	265	1500	131,00	100	BMS8479

1748-SC

self-locking stainless steel cable ties, black polyester coating

Material: stainless steel AISI 304 + polyester
 Locking device: roller ball type
 Self-extinguishing class: non-flammable
 Plenum rating: AH-1
 UV resistance: excellent
 Working temperature: -60 °C ÷ +300 °C
 Minimum installation temperature: -60 °C
 Resistance to chemicals: excellent
 Reference standards: EN 62275:2015-02
 Classification: type 2 (EN); type 2 (UL)



A	L	ØMAX	Trazione	€		
mm	mm	mm	N			
4.6	125	38	450	61,50	100	BMSC1345
4.6	200	61	450	71,50	100	BMSC2045
7.9	200	61	800	72,50	100	BMSC2079
4.6	290	90	450	80,00	100	BMSC3045
7.9	300	90	800	85,50	100	BMSC3079
4.6	360	112	450	88,00	100	BMSC3745
7.9	360	112	800	96,00	100	BMSC3779
7.9	520	163	800	121,00	100	BMSC5079
4.6	520	163	450	89,50	100	BMSC5245
4.6	680	214	450	101,50	100	BMSC6845
7.9	680	214	800	137,50	100	BMSC6879
4.6	840	265	450	108,00	100	BMSC8445
7.9	840	265	800	165,50	100	BMSC8479

1748-ST

automatic clamps for stainless steel cable ties, for cable ties with width ranging from 4.6 to 9 mm, automatic tension and cut control



BMS-T 202,50 1 BM1105



1639ESB

PVC electrical tape

Working temperature: 0-90 °C
 Tensile strength: 28N/cm equivalent to 18.6 N/mm²
 Elongation: 200%
 Adhesion to steel: 2.2N/cm
 Adhesion to backing: 2 N/cm
 Dielectric strength: 45kV/mm
 Flammability: flame retardant
 Reference standards: IEC 60454-2
 Classification: CEI EN 60454-3-1-5/F-PVCP/90



S	A	L	€		
mm	mm	m			
0.15	15	10	0,67	10	BMESB1510BI
0.15	15	10	0,67	10	BMESB1510BL
0.15	15	10	0,67	10	BMESB1510GI
0.15	15	10	0,67	10	BMESB1510GR
0.15	15	10	0,74	10	BMESB1510GV
0.15	15	10	0,67	10	BMESB1510MA
0.15	15	10	0,67	10	BMESB1510NE
0.15	15	10	0,67	10	BMESB1510RO
0.15	15	10	0,67	10	BMESB1510VE
0.15	15	25	1,64	10	BMESB1525BI
0.15	15	25	1,64	10	BMESB1525BL
0.15	15	25	1,64	10	BMESB1525GI
0.15	15	25	1,64	10	BMESB1525GR
0.15	15	25	1,71	10	BMESB1525GV
0.15	15	25	1,64	10	BMESB1525MA
0.15	15	25	1,64	10	BMESB1525NE
0.15	15	25	1,64	10	BMESB1525RO
0.15	15	25	1,64	10	BMESB1525VE
0.15	19	25	1,78	10	BMESB1925BI
0.15	19	25	1,78	10	BMESB1925BL
0.15	19	25	1,78	10	BMESB1925GI
0.15	19	25	1,78	10	BMESB1925GR
0.15	19	25	1,86	10	BMESB1925GV
0.15	19	25	1,78	10	BMESB1925MA
0.15	19	25	1,78	10	BMESB1925NE
0.15	19	25	1,78	10	BMESB1925RO
0.15	19	25	1,78	10	BMESB1925VE
0.15	25	25	2,53	8	BMESB2525BI
0.15	25	25	2,53	8	BMESB2525BL
0.15	25	25	2,53	8	BMESB2525GI
0.15	25	25	2,53	8	BMESB2525GR
0.15	25	25	2,60	8	BMESB2525GV
0.15	25	25	2,53	8	BMESB2525MA
0.15	25	25	2,53	8	BMESB2525NE
0.15	25	25	2,53	8	BMESB2525RO
0.15	25	25	2,53	8	BMESB2525VE

1639ESC

PVC electrical tape

Working temperature: 0-80 °C
 Tensile strength: 28N/cm equivalent to 18.6 N/mm²
 Elongation: 200%
 Adhesion to steel: 2.2N/cm
 Adhesion to backing: 2.2 N/cm
 Dielectric strength: 38kV/mm
 Flammability: flame retardant
 Reference standards: ASTM-D-1000 ; UL510
 Classification: CEI EN 60454-3-1-5/F-PVCP/90



S 0.18 mm, A 19 mm, L 20 m, € 2,38, 10 BMESC1920NE

1639ETA

PVC electrical tape for extreme temperatures

Working temperature: -18 ÷ +105 °C
 Tensile strength: 35N/cm equivalent to 19.4 N/mm²
 Elongation: 300%
 Adhesion to steel: 3.1N/cm
 Adhesion to backing: 2.7 N/cm
 Dielectric strength: 55.5kV/mm
 Flammability: flame retardant
 Reference standards: ASTM-D-1000 ; UL510
 Classification: CEI EN 60454-3-1-5/F-PVCP/90



S 0.18 mm, A 19 mm, L 20 m, € 7,15, 1 BMETA1920NE

1639EAB

EPR self-amalgamating electrical tape

Working temperature: -40 ÷ +90 °C
 Tensile strength: 2.4 N/mm²
 Elongation: 750%
 Dielectric strength: 29.5kV/mm
 Flammability: flame retardant
 Reference standards: ASTM-D-4388; ASTM-D-4325
 Excellent resistance to: moisture, corrosion, chemicals



S 0.76 mm, A 19 mm, L 9 m, € 14,60, 1 BMEAB1909NE





BLISTER PACK RANGE

free-service sales!

- **Increased visibility**
- **Display efficiency**
- **Bar code**



Blister pack support:

- *tearproof PVC*
- *4 formats for optimized display space*
- *New-generation fixing system with elastic band*

42K



mm	€	Hand	Code
5,5x5,5	7,90	5	000429505
6x6	8,00	5	000429506
7x7	8,05	5	000429507
8x8	8,20	5	000429508
9x9	8,75	5	000429509
10x10	9,00	5	000429510
11x11	9,60	5	000429511
12x12	9,85	5	000429512
13x13	9,90	5	000429513
14x14	11,10	5	000429514
15x15	12,10	5	000429515
16x16	12,60	5	000429516
17x17	13,30	5	000429517
18x18	14,00	5	000429518
19x19	14,40	5	000429519
20x20	16,20	3	000429520
21x21	17,40	3	000429521
22x22	18,00	3	000429522
23x23	19,40	3	000429523
24x24	20,20	3	000429524
25x25	21,50	2	000429525
26x26	23,10	2	000429526
27x27	25,00	2	000429527
28x28	26,00	2	000429528
29x29	28,00	2	000429529
30x30	29,00	2	000429530
32x32	32,00	2	000429532

55K



mm	€	Hand	Code
6x7	5,10	5	000559012
8x9	5,25	5	000559021
10x11	5,55	5	000559030
10x12	7,40	5	000559033
10x13	8,10	5	000559035
12x13	6,25	5	000559042
12x14	8,35	5	000559045
13x17	9,95	5	000559051
14x15	7,75	5	000559054
14x17	10,60	5	000559057
16x17	8,85	5	000559060
17x19	11,70	2	000559063
18x19	10,60	2	000559066
19x22	13,40	2	000559069
20x22	11,70	2	000559075
21x23	12,50	2	000559078
22x24	14,40	2	000559081
24x26	14,80	2	000559087
24x27	16,10	2	000559090
25x28	16,80	2	000559096
27x29	19,10	2	000559099
27x30	21,70	2	000559102
30x32	20,90	2	000559108

90K



mm	€	Hand	Code
6x7	9,75	5	000909006
8x9	10,40	5	000909012
10x11	11,30	5	000909018
12x13	12,30	5	000909027
14x15	13,50	5	000909033
16x17	15,30	5	000909039
18x19	17,80	5	000909045
20x22	20,40	3	000909051
21x23	23,00	2	000909057
24x26	25,50	2	000909063
24x27	28,50	2	000909067

mm	€	Hand	Code
25x28	30,50	2	000909070
27x29	33,00	2	000909073
30x32	37,50	2	000909080

93K



mm	€	Hand	Code
21x22	38,50	3	000939021

94K



mm	€	Hand	Code
8x10	16,60	2	000949008
9x11	17,30	2	000949009
10x11	18,20	2	000949010
11x13	18,80	2	000949011
12x14	19,90	2	000949012
13x15	19,90	2	000949013
14x15	23,20	2	000949014
14x17	23,70	2	000949015
17x19	24,30	2	000949017
19x22	26,00	2	000949019
22x24	31,50	2	000949022
24x27	35,00	2	000949024
30x32	45,00	2	000949030

96/SC9

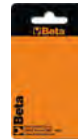

Code	€	Hand	Code
96/SC9	19,50	1	000960374

1,5-2-2,5-3-4-5-6-8-10 mm

96/ST6K

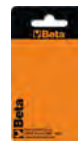

Code	€	Hand	Code
96/ST6K	14,00	3	000969370

2,5-3-4-5-6-8 mm

96N/ST6K



Code	€	Hand	Code
96N/ST6K	10,20	3	000969640

2,5-3-4-5-6-8 mm

96BPA/SC9



Code	€	Hand	Code
96BPA/SC9	45,00	1	000961974

1,5-2-2,5-3-4-5-6-8-10 mm

96BP-CL/SC9



Code	€	Hand	Code
96BP-CL/SC9	50,00	1	000961619

1,5-2-2,5-3-4-5-6-8-10 mm

96BPC/SC9



Code	€	Hand	Code
96BPC/SC9	41,00	1	000960354

1,5-2-2,5-3-4-5-6-8-10 mm

96C/AS



Code	€	Hand	Code
1/16	1,61	20	000961702
3/32	2,23	20	000961706
1/8	2,34	20	000961710
5/32	2,73	20	000961714
3/16	3,10	20	000961716
7/32	3,50	20	000961718
1/4	3,90	20	000961720
5/16	4,40	10	000961724
3/8	5,40	10	000961728

96LBP/SC9



Code	€	Hand	Code
96LBP/SC9	47,50	1	000961354

1,5-2-2,5-3-4-5-6-8-10 mm

96/BGS7



96/BGS7	€	🔧	📦
1,5-2-2,5-3-4-5-6 mm	29,00	1	000960367

96/BG7



96/BG7	€	🔧	📦
2,5-3-4-5-6-8-10 mm	31,00	1	000960368

96TK



mm	€	🔧	📦
2	11,30	5	000969934
2,5	11,30	5	000969935
3	11,80	5	000969936
4	12,20	5	000969938
5	12,60	5	000969940
6	14,30	5	000969941
8	18,20	3	000969943
10	20,80	3	000969945

97BTX/SC8



97BTX/SC8	€	🔧	📦
T9-T10-T15-T20-T25-T27-T30-T40	73,00	1	000970164

97BTXL/SC8



97BTXL/SC8	€	🔧	📦
T9-T10-T15-T20-T25-T27-T30-T40	84,50	1	000970364

111K



L mm	€	🔧	📦
100	23,10	3	001119010
150	23,90	3	001119015
200	29,00	3	001119020
250	36,00	3	001119025
300	47,50	3	001119030

123/K4



123/K4	€	🔧	📦
	31,50	1	001230504

142K



mm	€	🔧	📦
6	17,30	3	001429006
7	17,30	3	001429007
8	17,90	3	001429008
9	19,10	3	001429009
10	19,60	3	001429010
11	20,10	3	001429011
12	20,80	3	001429012
13	22,40	3	001429013
14	23,10	2	001429014
15	24,40	2	001429015
16	26,50	2	001429016
17	27,00	2	001429017
18	29,00	2	001429018
19	29,50	2	001429019
21	38,50	1	001429021
22	40,00	1	001429022
24	46,00	1	001429024

192/S2

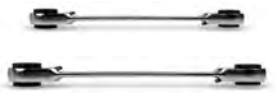

192/S2	€	🔧	📦
8x10/12x13 mm 16x17/18x19 mm	62,00	1	001920070

195K



mm	€	🔧	📦
8x10	19,90	2	001959010
12x13	22,60	2	001959013
14x15	23,70	2	001959015
16x18	27,50	2	001959018
17x19	29,00	2	001959019

374K



L mm	€	🔧	📦
240	37,00	1	003749024

850MQ



L mm	€	🔧	📦
233	22,70	1	008500910

855P



L1 mm	€	🔧	📦
240	68,50	1	008550010

860/58K



L mm	€	🔧	📦
126	73,00	1	008609884

860LP

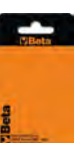

SxA mm	€	🔧	📦
0,5x3	1,79	5	008600005
0,6x4,5	1,79	5	008600010
0,8x5,5	1,79	5	008600015
1x5,5	1,79	5	008600020
1,2x6,5	1,79	5	008600025

860PH

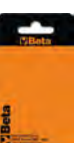

PH	€	🔧	📦
0	1,79	5	008600220
1	1,79	5	008600225
2	1,79	5	008600230
3	1,79	5	008600245
4	2,59	5	008600250

860PZ



PZ	€		
1	1,79	5	008600320
2	1,79	5	008600325
3	1,79	5	008600330
4	2,59	5	008600335

860PE



mm	€		
2	1,90	5	008600101
2,5	1,90	5	008600102
3	1,90	5	008600103
4	1,90	5	008600104
5	1,90	5	008600105
6	1,90	5	008600106
8	2,39	5	008600108
10	2,39	5	008600110

860TX



°	€		
T6	2,39	5	008600704
T7	2,39	5	008600705
T8	2,39	5	008600710
T9	2,39	5	008600715
T10	1,90	5	008600720
T15	1,90	5	008600725
T20	1,90	5	008600730
T25	1,90	5	008600735
T27	1,90	5	008600740
T30	1,90	5	008600745
T40	1,90	5	008600750

860RTX



°	€		
T9	2,59	5	008600550
T10	2,59	5	008600555
T15	2,59	5	008600560
T20	2,59	5	008600565
T25	2,59	5	008600570
T27	2,59	5	008600575
T30	2,59	5	008600580
T40	2,59	5	008600585

860/C27



860/C27	€		
	83,00	1	008600880

860MIX/A10



860MIX/A10	€		
	34,50	1	008600900

860TX/A10



860TX/A10	€		
	37,00	1	008600970

860MIX/A31



860MIX/A31	€		
	81,50	1	008600902

862F/A7



862F/A7	€		
	47,00	1	008620950

900K



mm	€		
4	4,15	10	009009040
4,5	4,15	10	009009045
5	4,15	10	009009050
5,5	4,15	10	009009055
6	4,15	10	009009060
7	4,15	10	009009070
8	4,15	10	009009080
9	4,15	10	009009090
10	4,15	10	009009100
11	4,15	10	009009110
12	4,15	10	009009120
13	4,20	10	009009130
14	4,25	10	009009140

900/20LK



L mm	€		
100	9,20	5	009009819

900/25K



L mm	€		
41	17,10	5	009009830

900BG/30K



L mm	€		
128	9,00	5	009009834

900/55K



L mm	€		
125	45,50	5	009009870

900/55ZK



L mm	€		
125	45,50	3	009009882

900/58K



L mm	€		
126	69,00	2	009009884



910AK

3/8"



mm	€	Hand	Code
6	6,50	5	009109006
7	6,50	5	009109007
8	6,50	5	009109008
9	6,50	5	009109009
10	6,50	5	009109010
11	6,50	5	009109011
12	6,65	5	009109012
13	6,65	5	009109013
14	6,65	5	009109014
15	6,65	5	009109015
16	7,45	5	009109016
17	7,45	5	009109017
18	7,45	5	009109018
19	7,45	5	009109019
20	8,00	5	009109020
21	8,00	5	009109021
22	8,20	5	009109022

910/21K

3/8"



L mm	€	Hand	Code
125	11,80	5	009109822

910/25K

3/8"



L mm	€	Hand	Code
54,6	21,10	5	009109830

910/55K

3/8"



L mm	€	Hand	Code
200	49,50	3	009109882

910/58K

3/8"



L mm	€	Hand	Code
222	76,50	1	009109884



920AK

1/2"



mm	€	Hand	Code
10	6,50	10	009209010
11	6,50	10	009209011
12	6,50	10	009209012
13	6,75	10	009209013
14	6,75	10	009209014
15	6,75	10	009209015
16	7,60	10	009209016
17	7,60	10	009209017
18	7,60	10	009209018
19	7,60	10	009209019
20	8,20	5	009209020
21	8,20	5	009209021
22	8,20	5	009209022
23	9,55	5	009209023
24	9,55	5	009209024
25	9,55	5	009209025
26	9,95	5	009209026
27	9,95	5	009209027
28	9,95	5	009209028
29	10,40	5	009209029
30	10,40	5	009209030
32	10,80	5	009209032

920/21K

1/2"



L mm	€	Hand	Code
125	16,10	5	009209822

920/25K

1/2"



L mm	€	Hand	Code
75	25,50	5	009209830

920/55K

1/2"



L mm	€	Hand	Code
275	60,50	3	009209882

920/58K

1/2"



L mm	€	Hand	Code
281	90,50	1	009209926

935K



mm	€	Hand	Code
6x7	7,80	5	009359105
8x9	8,35	5	009359111
10x11	9,30	5	009359115
12x13	10,60	5	009359117
14x15	12,00	5	009359126
16x17	13,20	5	009359128
18x19	15,50	5	009359131
20x22	18,80	3	009359138

937K



mm	€	Hand	Code
6x6	8,35	5	009379006
7x7	8,70	5	009379007
8x8	9,10	5	009379008
9x9	9,60	5	009379009
10x10	10,10	5	009379010
11x11	10,60	5	009379011
12x12	11,50	5	009379012
13x13	11,80	5	009379013
14x14	13,00	5	009379014
15x15	14,30	5	009379015
16x16	15,40	5	009379016
17x17	16,00	5	009379017
18x18	16,30	5	009379018
19x19	17,00	5	009379019
20x20	19,30	5	009379020
21x21	20,90	3	009379021
22x22	21,90	3	009379022

943BKK



mm	€	Hand	Code
5,5	16,30	5	009439005
6	16,30	5	009439006
7	17,50	5	009439007
8	17,50	5	009439008
10	19,10	3	009439010
13	20,10	3	009439013

951K



mm	€	Hand	Code
2	18,20	5	009519521
2,5	18,20	5	009519525
3	18,20	5	009519530
3,5	18,80	5	009519535
4	18,80	5	009519540
4,5	20,40	5	009519545
5	20,40	5	009519550
6	23,50	5	009519560
8	25,50	5	009519580
10	31,50	5	009519610

1032K



L mm	€	5	010329013
140x0,9	23,80	5	010329013
140x1,3	23,30	5	010329014
180	25,00	5	010329017

1033K



L mm	€	5	010339013
140x0,9	27,00	5	010339013
140x1,3	26,50	5	010339014
180	27,50	5	010339017

1034K



L mm	€	5	010349013
130x0,9	27,00	5	010349013
130x1,3	26,50	5	010349014
170	27,50	5	010349017

1036K



L mm	€	5	010369013
140x0,9	26,00	5	010369013
140x1,3	25,00	5	010369014
175	26,50	5	010369017

1037K



L mm	€	5	010379013
140x0,9	29,00	5	010379013
140x1,3	27,50	5	010379014
175	29,00	5	010379017

1038K



L mm	€	5	010389013
135x0,9	29,00	5	010389013
135x1,3	27,50	5	010389014
175	29,00	5	010389017

1044K



L mm	€	5	010449250
250	33,00	5	010449250

1044FK



L mm	€	5	010449015
250	26,00	5	010449015

1046K



L mm	€	5	010469240
240	37,00	5	010469240

1048K



L mm	€	3	010489010
175	32,00	3	010489010
250	35,00	5	010489250

1048VK



L mm	€	3	010489110
175	27,00	3	010489110
250	31,00	5	010489025

1052K



L mm	€	3	010529014
140	25,50	3	010529014
190	29,00	3	010529019
240	31,00	3	010529024

1082K



L mm	€	5	010829004
140	24,70	5	010829004
160	26,00	5	010829006

1082GK



L mm	€	5	010829064
140	21,30	5	010829064
160	22,40	5	010829066

1082BMK



L mm	€	3	010829034
140	30,50	3	010829034
160	34,00	3	010829036

1082GBMK



L mm	€	3	010829264
140	27,00	3	010829264
160	30,00	3	010829266

1084K



L mm	€	3	010849006
160	29,00	3	010849006

1084GK



L mm	€		
160	25,00	5	010849066

1084BMK

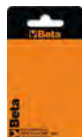

L mm	€		
160	35,50	3	010849036

1084GBMK

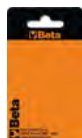

L mm	€		
160	38,50	3	010849266

1088K



L mm	€		
160	36,00	2	010889006

1088BMK

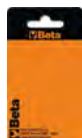

L mm	€		
160	43,50	2	010889036

1096K



L mm	€		
200	22,20	5	010969020

1098K



L mm	€		
190	19,30	5	010989190
220	21,60	5	010989220

1098PLK



L mm	€		
220	24,00	5	010989320

1112K



L mm	€		
200	25,00	2	011129020

1122K



L mm	€		
250	34,50	2	011229020

1123K



L mm	€		
250	34,50	2	011239020

1124K



L mm	€		
250	34,50	2	011249020



1128BAX



L mm	€		
150	32,00	5	011280088

1128BMX



L mm	€		
147	16,90	5	011280051

1128BSX



L mm	€		
148	29,00	5	011280061

1128FX



L mm	€		
145	31,00	5	011280090

1128FXS



L mm	€	🔧	📄
145	36,50	5	011280095

1129BMK



L mm	€	🔧	📄
145	16,50	5	011299000

1130BMX



L mm	€	🔧	📄
185	19,00	1	011300002

1132K



L mm	€	🔧	📄
170	48,00	2	011329107

1132BMK



L mm	€	🔧	📄
170	59,00	2	011329137

1142BMK



L mm	€	🔧	📄
160	39,00	3	011429036

1149F



L mm	€	🔧	📄
175	16,50	1	011490010

1150K



L mm	€	🔧	📄
160	21,80	5	011509046
180	23,90	5	011509048
200	26,00	5	011509050
220	28,50	2	011509052

1150GK



L mm	€	🔧	📄
160	20,50	5	011509066
180	22,30	5	011509068
200	24,70	5	011509070
220	26,00	2	011509072

1150BMK



L mm	€	🔧	📄
160	27,00	3	011509146
180	29,50	3	011509148
200	32,50	3	011509150
220	35,50	2	011509152

1150GBMK



L mm	€	🔧	📄
160	25,50	3	011509266
180	27,00	3	011509268
200	30,50	3	011509270
220	32,50	2	011509272

1162K



L mm	€	🔧	📄
160	25,50	5	011629006
200	29,50	5	011629010

1162GK



L mm	€	🔧	📄
160	21,80	5	011629066
200	25,50	5	011629070

1162BMK



L mm	€	🔧	📄
160	31,00	3	011629036
200	35,50	3	011629040

1162GBMK



L mm	€	🔧	📄
160	27,00	3	011629266
200	31,50	3	011629270

1164K



L mm	€	🔧	📄
160	28,00	5	011649006
200	31,00	5	011649010

1164BMK



L mm	€	🔧	📄
160	34,50	3	011649036
200	38,50	3	011649040

1166K



L mm	€		
160	25,50	5	011669006
200	29,50	5	011669010

1166GK



L mm	€		
160	21,80	5	011669066
200	25,50	5	011669070

1166BMK



L mm	€		
160	31,00	3	011669036
200	35,50	3	011669040

1166GBMK



L mm	€		
160	27,00	3	011669266
200	31,50	3	011669270

1168K



L mm	€		
160	28,00	5	011689006
200	31,00	5	011689010

1168GK



L mm	€		
160	23,90	5	011689066
200	27,00	5	011689070

1168BMK



L mm	€		
160	34,50	3	011689036
200	38,50	3	011689040

1168GBMK



L mm	€		
160	30,00	3	011689266
200	34,50	3	011689270

1201E/K



SxAxL mm	€		
0,4x2,5x50	4,15	5	012019203
0,4X2,5x75	4,30	5	012019206
0,5x3x75	4,35	5	012019209
0,5x3x100	4,70	5	012019212
0,6x3,5X75	4,70	5	012019218
0,6x3,5x100	4,80	5	012019221
0,8x4x100	4,85	5	012019230
0,8x4x125	5,05	5	012019233
0,8x4X150	5,50	5	012019236
1,0x5,5x100	6,00	5	012019239
1,0x5,5X125	6,30	5	012019240
1,0x5,5x150	6,45	5	012019242
1,2x6,5x100	7,05	5	012019248
1,2x6,5x125	7,30	5	012019250
1,2x6,5x150	7,45	5	012019251
1,2x8x150	9,60	3	012019257
1,2x8X200	10,40	3	012019260
1,6x10x200	11,70	3	012019266

1201EN/K



SxAxL mm	€		
0,8x4x30	5,90	3	012019303
1,2x6,5x30	6,20	3	012019306

1202E/K



PHxDxL mm	€		
0x3x60	4,30	5	012029203
0x3X100	4,80	5	012029206
1x4,5x80	5,45	5	012029209
1x4,5x120	6,15	5	012029212
2x6x100	7,30	5	012029218
2x6x150	7,90	5	012029221
3x8x150	10,10	3	012029224
4x9,5x200	13,00	3	012029227

1202EN/K



PHxDxL mm	€		
1x4,5x30	5,90	3	012029303
2x6x30	6,20	3	012029306

1204E/K



SxDxL mm	€		
0,4x2,5x60	4,25	5	012049103
0,6x3x75	4,35	5	012049106
0,5x3x100	4,45	5	012049109
0,8x4x100	4,95	5	012049112
0,8x4x125	5,20	5	012049115
1,0x5x125	6,05	5	012049118
1,0x5x150	6,50	5	012049121
1,2x6,5x150	7,05	5	012049124

1207E TX/K



	€		
T5	6,30	5	012079105
T6	6,65	5	012079106
T7	6,85	5	012079107
T8	6,95	5	012079108
T9	7,20	5	012079109
T10	8,15	5	012079110
T15	8,30	5	012079115
T20	8,40	5	012079120
T25	8,65	5	012079125
T27	9,20	5	012079127
T30	9,30	5	012079130
T40	10,90	2	012079140
T45	11,80	2	012079145

1208E RTX/K



	€		
T9	7,30	5	012089109
T10	8,15	5	012089110
T15	8,65	5	012089115
T20	8,80	5	012089120
T25	9,05	5	012089125
T27	9,80	5	012089127
T30	10,20	5	012089130
T40	11,90	2	012089140

1209E PZ/K



PZ	€		
0	4,95	5	012099200
1	6,45	5	012099203
2	8,15	5	012099206
3	12,20	3	012099209
4	13,50	3	012099212

1209EN-PZ/K



	€	U	U
1	5,90	3	012099303
2	6,20	3	012099306

1253



SxAxL mm	€	U	U
0,5x3,5x100	9,10	5	012530001

1254



SxAxL mm	€	U	U
0,5x3x44	10,00	5	012540001

1260K



SxAxL	€	U	U
0,4x2,5x50	5,55	5	012609003
0,4x2,5x75	5,80	5	012609006
0,5x3x75	5,95	5	012609009
0,5x3x100	6,10	5	012609012
0,6x3,5x75	6,30	5	012609018
0,6x3,5x100	6,45	5	012609021
0,8x4x100	6,95	5	012609030
0,8x4x125	7,20	5	012609033
0,8x4x150	7,45	5	012609036
1x5,5x100	7,95	5	012609039
1x5,5x150	8,80	5	012609042
1,5x6,5x100	9,50	5	012609048
1,2x6,5x150	10,20	5	012609051
1,2x8x150	12,30	3	012609057
1,2x8x200	12,80	3	012609060
1,6x10x200	15,40	3	012609066

1260NK



SxAxL mm	€	U	U
0,8x4x30	7,30	5	012609103
1,2x6,5x30	8,05	5	012609106

1260EK



SxAxL mm	€	U	U
1,2x6,5x150	13,10	3	012609156
1,2x8x175	16,00	3	012609157
1,6x10x200	18,50	2	012609159
2x12x250	21,30	2	012609162

1262K



PHxDxL mm	€	U	U
0x3x60	5,95	5	012629003
0x3x100	6,25	5	012629006
1x4,5x80	7,70	5	012629009
1x4,5x120	8,30	5	012629012
2x6x100	9,40	5	012629018
2x6x150	10,40	5	012629021
3x8x150	13,60	3	012629024
4x10x200	17,30	3	012629027

1262NK



PHxDxL	€	U	U
1x4,5x30	7,30	5	012629103
2x6x30	8,05	5	012629106

1262EK



PHxDxL mm	€	U	U
2x6x150	13,10	3	012629153
3x8x175	15,80	3	012629156
4x10x200	19,90	3	012629159

1264K



SxDxL mm	€	U	U
0,5x2,5x60	5,55	5	012649003
0,6x3x75	5,95	5	012649006
0,6x3x100	6,10	5	012649009
0,8x4x100	6,95	5	012649012
0,8x4x125	7,20	5	012649015
1x5x125	8,05	5	012649018
1x5x150	8,50	5	012649021
1,2x6,5x150	10,20	5	012649024

1267TKK



T	€	U	U
T5	8,15	5	012679005
T6	8,50	5	012679006
T7	8,80	5	012679007
T8	9,20	5	012679008
T9	9,60	5	012679009
T10	10,00	5	012679010
T15	10,60	5	012679015
T20	11,00	5	012679020
T25	11,80	5	012679025
T27	12,30	5	012679027
T30	13,00	5	012679030
T40	15,00	2	012679040
T45	16,40	2	012679045

1268RTKK



T	€	U	U
T9	10,40	3	012689009
T10	10,70	3	012689010
T15	11,00	3	012689015
T20	11,80	3	012689020
T25	12,10	3	012689025
T27	13,00	3	012689027
T30	13,20	3	012689030
T40	15,20	2	012689040

1269PZK



PZ	€	U	U
0	6,65	5	012699000
1	8,65	5	012699001
2	10,50	5	012699002
3	14,60	3	012699003
4	18,70	3	012699004

1269N/PZK



PZ	€	U	U
1	7,30	5	012699011
2	8,05	5	012699012

Beta
Quality Tools

1290K



SxAxL mm	€	🔧	📄
0,4x2,5x50	6,85	5	012909003
0,4x2,5x75	7,05	5	012909006
0,5x3x75	7,20	10	012909009
0,5x3x100	7,60	10	012909012
0,6x3,5x75	8,15	10	012909018
0,6x3,5x100	8,30	10	012909021
0,8x4x100	8,40	10	012909030
0,8x4x125	8,65	10	012909033
0,8x4x150	9,20	10	012909036
1x5,5x100	9,40	10	012909039
1x5,5x150	10,50	10	012909042
1,2x6,5x100	11,50	10	012909048
1,2x6,5x150	12,10	10	012909051
1,2x8x150	15,20	3	012909057
1,2x8x200	16,10	3	012909060
1,6x10x200	18,90	3	012909066

1290NK



SxAxL mm	€	🔧	📄
0,8x4x30	8,90	5	012909103
1,2x6,5x30	9,90	5	012909106

1290K/INOX



SxAxL mm	€	🔧	📄
0,4x2,5x50	9,05	4	012909403
0,5x3x75	9,20	4	012909409
0,8x4x100	9,60	4	012909430
1,0x5,5x150	11,90	4	012909442
1,2x6,5x150	13,70	4	012909451

1292K



PHxDxL mm	€	🔧	📄
0x3x60	6,55	10	012929003
0x3x100	7,45	5	012929006
1x4,5x80	9,05	10	012929009
1x4,5x120	10,00	10	012929012
2x6x100	11,60	10	012929018
2x6x150	12,60	10	012929021
3x8x150	15,90	3	012929024
4x10x200	21,70	3	012929027

1292NK



PHxDxL mm	€	🔧	📄
1x4,5x30	8,50	5	012929103
2x6x30	9,30	5	012929106

1292K/INOX



PHxDxL mm	€	🔧	📄
0x3x60	8,40	4	012929403
1x4,5x80	10,00	4	012929409
2x6x100	11,90	4	012929418

1294K



SxDxL mm	€	🔧	📄
0,5x2,5x60	6,50	5	012949003
0,6x3x75	6,70	5	012949006
0,8x4x100	8,40	5	012949012
1x5x125	10,60	5	012949018

1298RTKX



⊕	€	🔧	📄
T9	13,80	5	012989009
T10	14,10	5	012989010
T15	15,00	5	012989015
T20	15,10	5	012989020
T25	15,40	5	012989025
T27	16,60	5	012989027
T30	17,30	5	012989030
T40	18,50	2	012989040

1299PZK



PZ	€	🔧	📄
0	9,40	5	012999000
1	10,90	5	012999003
2	14,70	5	012999006

1299N/PZK



PZ	€	🔧	📄
1	10,60	5	012999021
2	11,60	5	012999024

1472VW



L mm	€	🔧	📄
200	44,50	1	014720051

1473P



A Max mm	€	🔧	📄
53	34,50	1	014730020

1497RC



1497RC	€	🔧	📄
	71,00	1	014970351

1600Q 8



1600Q 8	€	🔧	📄
	27,50	1	016000008

1600Q 10



1600Q 8	€	🔧	📄
	27,50	1	016000008

1603K



🔧 mm2	€	🔧	📄
0÷8	15,50	5	016039001

1603BK



mm ²	€		
0-8	57,50	2	016039010

1691BM

CE



L m	€		
5	15,00	1	016910205
8	22,50	1	016910208
10	27,50	1	016910210

1692

CE



L m	€		
2	7,30	5	016920052
3	9,10	5	016920053
5	12,90	5	016920055
8	18,70	5	016920058

1693

CE



IP54



H mm	€		
100	115,50	1	016930020

1729CG



L mm	€		
310	22,20	2	017290200

1729DM 450



L mm	€		
450	25,50	4	017290450

1741U



200 mm



Ø mm	2,4	3	3,2	4	4,8
Aluminium	•	•	•	•	•
Steel	•	•	•	•	•
Stainless steel	•	•	•	•	•

1741U	€		
	44,00	1	017410450

1741B



250 mm

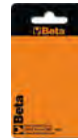

Ø mm	2,4	3,2	4	4,8	5
Aluminium	•	•	•	•	•
Steel	•	•	•	•	•
Stainless steel	•	•	•	•	•

1741B	€		
	36,50	1	017410000

1760K

CE



180 mm

CAT III-1000V

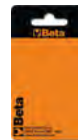

1760K	€		
	35,00	1	017600140

1762K



Ø mm	€		
2-2,5-3 3,5-4-4,5	29,50	2	017629001

1771



18 mm

170 mm



1771	€		
	8,95	10	017710000

1770BM



L mm	€		
140	12,10	10	017700050

1771BM



L mm	€		
170	19,50	10	017710050

1771HD



L mm	€		
190	21,90	5	017710100

1772R



L mm	€		
125	16,50	5	017720006

Beta

1773A



L mm 180 € 17,30 10 017730000

1777BMT NOT AVAILABLE IN THE UK, IRELAND AND USA



L mm 170 € 26,50 5 017770050

1777T



L mm 160 € 24,70 5 017770030

1783



L mm 215 € 14,50 5 017830021
L mm 240 € 16,20 5 017830024

1820



€ 42,50 1 018200003
1820 30 30W
L = 210mm
€ 48,00 1 018200006
1820 60 60W
L = 220mm
€ 68,50 1 018200008
1820 80 80W
L = 260mm

1822



€ 104,50 1 018220012
1822 120 120W
LxA = 250x125 mm
€ 110,00 1 018220018
1822 180 180W
LxA = 250x125mm
€ 137,00 1 018220032
1822 320 320W
LxA = 250x140mm

1833S



L mm 150 € 35,50 1 018330002

1833M



L mm 162 € 44,50 1 018330003

1833L



L mm 196 € 73,50 1 018330004

1833KL



L mm 300 € 92,00 1 018330005

1833L/USB



L mm 240 € 107,50 1 018330054

1834RR

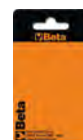

€ 48,50 1 018340520
1834RR

1836A



€ 49,00 1 018360050
1836A

1836B



€ 120,50 1 018360200
1836B

Beta

Beta

1837F



L mm 460 € 79,00 1 018370050

1837F/USB



L mm 460 € 117,00 1 018370060

1838COB



1838COB € 86,50 1 018380010

1838P



1838P € 74,50 1 018380005

1838S



L mm 260 € 80,00 1 018380122

1838SLIM

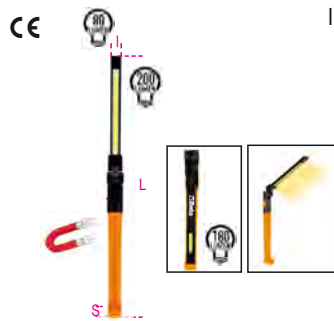

L mm 307 € 67,50 1 018380221

6888B1/4

blister support for 1/4" sockets



6888B1/4 € 0,57 50 068880900

6888B3/8

blister support for 3/8" sockets



6888B3/8 € 0,68 50 068880910

6888B1/2

blister support for 1/2" sockets



6888B1/2 € 0,68 50 068880920



Beta



DISPLAY UNITS FOR SALES POINTS

Beta
SHOP
in Shop



38/DS1

wall-mounted display
with 75 punches



495x260x332 mm

display with assortment	€	1	000380701	n.
38/DS1	676,00			
30	Ø 2 - 3 - 4 - 5 - 6 mm			5
31	Ø 2 - 3 - 4 - 5 - 6 - 8 - 10 mm			5
32	Ø 3 - 4 - 5 mm			5

empty display	€	1	000380751
38/DVS1	104,50		

38/DS2

wall-mounted display
with 65 chisels

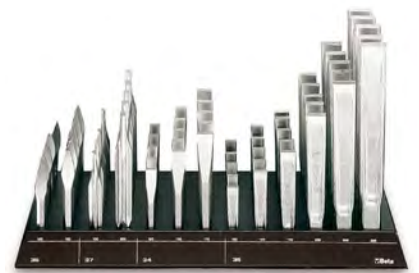

495x260x332 mm

display with assortment	€	1	000380702	n.
38/DS2	1.260,00			
34	125 - 150 - 175 mm			5
35	100 - 125 - 150 - 200 - 250 - 300 mm			5
36	125 - 150 mm			5
37	150 - 200 mm			5

empty display	€	1	000380752
38/DVS2	104,50		

**BUILD
your Beta corner**

www.beta-tools.com/planner3d/

942BK/DG

wall-mounted display
with 43 hi-torque hexagon nut spinners,
short series



330x260x332 mm

display
with assortment
942BK/DG € 677,00 1 009420701

	n.
942BX 5 - 5,5 mm	3
6 - 7 mm	6
8 - 9 - 10 mm	5
11 mm	2
12 mm	3
13 mm	5

empty display
942BK/DVG € 92,50 1 009420751

943BK/DG

wall-mounted display
with 43 hi-torque hexagon nut spinners,
long series



330x260x332 mm

display
with assortment
943BK/DG € 729,00 1 009430701

	n.
943BX 5 - 5,5 mm	3
6 - 7 mm	6
8 - 9 - 10 mm	5
11 mm	2
12 mm	3
13 mm	5

empty
display
943BK/DVG € 92,50 1 009430751

944BK/DG

wall-mounted display
with 43 deep hi-torque
hexagon nut spinners with handles, long
series



330x260x332 mm

display
with assortment
944BK/DG € 844,00 1 009440701

	n.
944BX 5 - 5,5 mm	3
6 - 7 mm	6
8 - 9 - 10 mm	5
11 mm	2
12 mm	3
13 mm	5

empty
display
944BK/DVG € 92,50 1 009430751

943MQ/BG

wall-mounted display
with 30 hexagon nut spinners



⚠ 1000 V ⚡ 330x260x332 mm

display
with assortment
943MQ/BG € 585,00 1 009430281

	n.
943MQ 5,5 - 6 - 7 - 8 - 10 - 13 mm	5

empty
display
943BG-MQ/DV € 92,50 1 009430285

1203/E1P

wall-mounted display with 82 screwdrivers



495x260x310 mm

display with assortment
1203E/E1P € 449,00 1 012031301

	n.
1201 0,4x2,5x50 - 0,5x3x75 - 0,6x3,5x100 - 0,8x4x100 - 0,8x4x125 mm	7
1,0x5,5x100 - 1,0x5,5x150 - 1,2x6,5x150 mm	6
1,2x8x150 mm	5
1202 PH0x3x60 mm	7
PH1x4,5x80 - PH2x6x100 mm	6
PH3x8x150 mm	5

empty display
1203E/EV1P € 106,00 1 012031351

1203/E4P

wall-mounted display with 85 screwdrivers



495x260x310 mm

display with assortment
1203E/E4P € 431,00 1 012031304

	n.
1201 0,4x2,5x50 - 0,5x3x75 - 0,8x4x125 mm	7
1,0x5,5x100 - 1,0x5,5x150 - 1,2x6,5x150 mm	6
1204 0,4x2,5x60 - 0,5x3x100 - 0,8x4x100 mm	7
1,0x5x125 mm	6
1209PZ PZ0x3x60 mm	7
PZ1x4,5x80 - PZ2x6x100 mm	6

empty display
1203E/EV4P € 106,00 1 012031354

1203/E5P

wall-mounted display with 82 screwdrivers



495x260x310 mm

display with assortment
1203/E5P € 457,00 1 012031305

	n.
➕ 1202 PH0x3x60 mm	7
PH1x4,5x80 - PH1x4,5x120	6
PH2x6x100 - PH2x6x150 mm	5
PH3x8x150 mm	5
● 1204 0,4x2,5x60 - 0,5x3x100 - 0,8x4x100 mm	7
1,0x5x125 mm	6
➕ 1209PZ PZ0x3x60 mm	7
PZ1x4,5x80 - PZ2x6x100 mm	6

empty display
1203/EV5P € 106,00 1 012031355

1203/E10P

wall-mounted display with 80 screwdrivers



495x260x310 mm

display with assortment
1203/E10P € 615,00 1 012031310

	n.
⊖ 1207TX T6	4
T7	3
T8	7
T9 - T10 - T15 - T20 - T25	6
T27 - T30	3
⊖ 1208RTX T9 - T10	3
T15 - T20 - T25	6
T27 - T30	3

empty display
1203/EV10P € 106,00 1 012031360

1263/E78

wall-mounted display with 78 screwdrivers



495x260x310 mm

display with assortment
1263/E78 € 578,00 1 012630510

● 1260 2,5x75-3x75-3,5x100 mm	7
4x100-4x125-5,5x100-5,5x150-6,5x150 mm	6
8x150 mm	4
➕ 1262 PH0x60 mm	7
PH1x80-PH2x100 mm	6
PH3x150	4

empty display
1263/EV78 € 106,00 1 012630511

1263/E74

wall-mounted display with 74 screwdrivers



495x260x310 mm

display with assortment
1263/E74 € 539,00 1 012630540

● 1264 2,5x60 mm	7
3x75 mm	3
3x100 - 4x100 mm	4
4x125 - 5x150 mm	2
5x125 - 6,5x150 mm	4
➕ 1262 PH 8x150	3
PH 3x60 - 3x100 mm	7
PH 4,5x80 - 4,5x120 mm	6
PH 6x100 mm	10
PH 6x150 mm	5

empty display
1263/EV74 € 106,00 1 012630541

1263/E85

wall-mounted display with 85 screwdrivers



495x260x377 mm

display with assortment
1263/E85 € 643,00 1 012630550

● 1260 2,5x50 mm	7
2,5x75 mm	6
3x75 - 3x100 - 3,5x100 mm	7
4x100 - 4x125 - 5,5x125	6
5,5x150 - 6,5x150 mm	4
8x150 mm	4
● 1260E 10x200 mm	3
12x250 mm	2
4x30 - 6,5x30 mm	6

empty display
1263/EV85 € 106,00 1 012630551

1263/E70

wall-mounted display with 70 screwdrivers



495x260x327 mm

display with assortment
1263/E70 € 633,00 1 012630560

➕ 1262 PH0x60 - PH0x100 mm	7
PH1x80 - PH1x120 mm	6
PH2x100 mm	9
PH2x150 - PH3x150 mm	5
PH4x200 mm	4
➕ 1262E PH2x150 mm	5
PH3x175 mm	4
➕ 1262N PH1x30 - PH2x30 mm	6

empty display
1263/EV70 € 106,00 1 012630561

1263/E50

wall-mounted display
with 50 screwdrivers



330x260x269 mm

display
with assortment
1263/E50 € 332,00 1 012630570

	n.
● 1264 2,5x60 - 3x75 - 3x100 mm	7
4x100 - 4x125 - 5x125 - 5x150 mm	6
6,5x150 mm	5

empty
display
1263/EV50 € 92,50 1 012630571

1263/E62

wall-mounted display
with 62 screwdrivers



495x260x257 mm

display
with assortment
1263/E62 € 612,00 1 012630590

	n.
● 1267TX T5	5
T6	6
T7	5
T8	6
T9	5
T10 - T15 - T20	6
T25	5
T27 - T30	4
T40 - T45	2

empty
display
1263/EV62 € 106,00 1 012630591

1263/E39

wall-mounted display
with 39 screwdrivers



330x260x257 mm

display
with assortment
1263/E39 € 433,00 1 012630595

	n.
● 1268RTX T9x60 - T10x80 - T15x80	6
T20x100 - T25x100 mm	4
T27x115 mm	3
T30x115 mm	2
T40x130 mm	2

empty
display
1263/EV39 € 92,50 1 012630596

1263/E40

wall-mounted display
with 40 screwdrivers



330x260x327 mm

display
with assortment
1263/E40 € 385,00 1 012630580

	n.
● 1269 PZ0x60 mm	7
PZ1x80 mm	6
PZ2x100 - PZ3x150 - PZ4x200 mm	5
● 1269N PZ1x30 - PZ2x30 mm	6

empty
display
1263/EV40 € 92,50 1 012630581

1273MQ/E1

wall-mounted display with 40 screwdrivers



△ 1000 V

330x260x332 mm

display
with assortment
1273MQ/E1 € 491,00 1 012730312

	n.
● 1272MQ PH0x60 - PH1x80 mm	5
PH2x100 mm	3
PH3x150 mm	2
● 1274MQ 3x100 - 4x100 - 5,5x125 - 6,5x150 mm	5
8x175 mm	3
10x200 mm	2

empty
display
1273BG-MQ/DV € 92,50 1 012730651

1273MQ/E4

wall-mounted display
with 43 screwdrivers



△ 1000 V

330x260x332 mm

display
with assortment
1273MQ/E4 € 672,00 1 012730315

	n.
● 1272MQF 4,5x80 - 6x100 mm	3
● 1274MQF 3,5x100 - 4,5x100 - 5,5x125 - 6,5x150 mm	3
● 1275MQ/C 4,5x80 - 6x100 mm	5
● 1276MQ/C 4,5x80 - 6x100 mm	5
● 1279MQ/F 4,5x80 mm	3
6x100 mm	2

empty
display
1273BG-MQ/DV4 € 92,50 1 012730655

1293BX/DA

wall-mounted display with 90 screwdrivers



495x260x332 mm

display with assortment		€	1	012930701
n.				
● 1290	3x75 - 3,5x100 - 4x100 - 4x125 5,5x100 - 5,5x150 mm 6,5x150 mm		7	
	8x150 mm		3	
	10x200 mm		2	
● 1290N	4x30 - 6,5x30 mm		3	
⊕ 1292	PH0x60 - PH1x80 mm PH2x100 mm PH3x150 mm		7 6 5	
⊕ 1292N	PH1x30 - PH2x30 mm		3	

empty display		€	1	012930751
1293BX/DVA		106,00		

1293BX/DD

wall-mounted display with 48 screwdrivers



330x260x332 mm

display with assortment		€	1	012930704
n.				
● 1294	2,5x60 - 3x75 - 3x100 - 4x100 4x150 - 5x125 mm 6,5x150 mm	395,00	7	6

empty display		€	1	012930754
1293BX/DVD		92,50		

1293BX/DE

wall-mounted display with 42 screwdrivers



330x260x332 mm

display with assortment		€	1	012930705
n.				
⊕ 1299PZ	PZ0x60 - PZ1x80 mm PZ2x100 mm PZ3x150 - PZ4x200 mm	587,00	7 6 5	
⊕ 1299N/PZ	PZ1x30 - PZ2x30 mm		6	

empty display		€	1	012930755
1293BX/DVE		92,50		

1293BX/DF

wall-mounted display with 59 screwdrivers



330x260x332 mm

display with assortment		€	1	012930706
n.				
⊕ 1297TX	T6 - T8 - T10 - T15 - T20 - T25 T27 - T30 T40	780,00	7 6 5	

empty display		€	1	012930756
1293BX/DVF		92,50		

C68

Beta wall display, empty



1000x560x2200 mm

		€	1	068000001
C68/1	1 m	1.825,00		
C68/2	2 m	3.180,00		
C68/3	3 m	4.530,00		
C68/4	4 m	5.880,00		
C68/5	5 m	7.240,00		
C68/6	6 m	8.590,00		
C68/7	7 m	9.940,00		
C68/8	8 m	11.290,00		
C68/9	9 m	12.650,00		
C68/10	10 m	14.000,00		

C68 G

"gondola" display



1000x1120x1600 mm

		€	1	068000051
C68G/1	1 m	1.660,00		
C68G/2	2 m	3.060,00		
C68G/3	3 m	4.460,00		
C68G/4	4 m	5.860,00		

C88 R/1

Robur wall display, empty



1000x560x2200 mm

C88R/1 1 m € 1.825,00 1 088000001

C88VE

display tray for display walls C88

suitable for housing coils of chains item 8120



C88VE € 227,00 1 088000120

C88SE

display tray for Genovese chain reels



C88SE € 499,00 1 088000130

1700x600x600 mm

6888

hooks for displays C60 - C61 - C68 - C88



	€		
6888S1	3,75	10	068880011
6888S2	3,75	10	068880012
6888D1	5,90	5	068880021
6888D2	5,90	5	068880022
6888D4	6,10	5	068880024
6888D5	6,10	5	068880025
6888T1	8,40	5	068880031
6888T2	8,40	5	068880032
6888CT	15,80	1	068880044
6888B	47,50	1	068880100
6888GA	18,70	3	068880120
6888S-1/4	34,50	1	068880605
6888S-3/8	34,50	1	068880610

6800 VE

showcase for wall displays C68 and C68 R/1

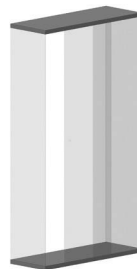

	€		
6800VE/1	1 m	909,00	1 068000401
6800VE/2	2 m	1.385,00	1 068000402
6800VE/3	3 m	1.865,00	1 068000403
6800VE/4	4 m	2.340,00	1 068000404
6800VE/5	5 m	2.820,00	1 068000405

Beta

ACCESSORIES



	€		
6800AE	181,50	1	068000145
6800AI	375,00	1	068000140
6800AD/P	639,00	1	068000143



	€		
6800CB/100	210,00	1	068000104
6800FB/100	74,00	1	068000109
6800FO/100	50,50	1	068000108
6800PL	213,00	1	068000137
6800RP/100	67,50	1	068000150
6800GR/37	28,50	1	068000159



	€		
6800PM/40	67,50	1	068000171
6800PM/80	91,00	1	068000172

6600 M/14

assortment of 154 tools,
with hooks without panel

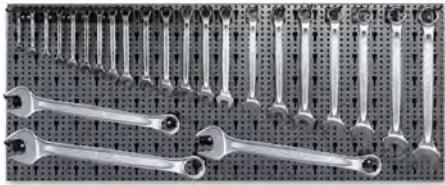

6600 M/14 € 2.220,00 1 066000014

6600 M/22

assortment of 108 tools,
with hooks without panel



6600 M/22 € 1.470,00 1 066000022

6600 M/27

assortment of 25 tools,
with hooks without panel



6600 M/27 € 1.033,00 1 066000027

6600 M/29

assortment of 173 tools,
with hooks without panel

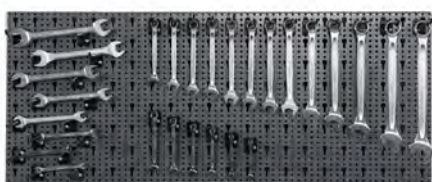

6600 M/29 € 1.950,00 1 066000029

6600 M/33

assortment of 37 tools, with hooks without panel



6600 M/33 € 1.575,00 1 066000033

6600 M/40

assortment of 100 tools,
with hooks without panel



6600 M/40 € 2.520,00 1 066000040

6600 M/42

assortment of 65 tools,
with hooks without panel



6600 M/42 € 1.625,00 1 066000042

6600 M/44

assortment of 48 tools,
with hooks without panel



6600 M/44 € 1.390,00 1 066000044

6600 M/47

assortment of 65 tools,
with hooks without panel



6600 M/47 € 1.480,00 1 066000047

6600 M/51

assortment of 257 tools
with hooks without panel



6600 M/51 € 2.620,00 1 066000051

6600 M/52

assortment of 176 tools
with hooks without panel



6600 M/52 € 1.710,00 1 066000052

6600 M/58

assortment of 150 tools
with hooks without panel



6600 M/58 € 1.860,00 1 066000058

6600 M/59

assortment of 220 tools,
with hooks without panel



6600 M/59 € 1.965,00 1 066000059

6600 M/61

assortment of 71 tools,
with hooks without panel



6600 M/61 € 2.365,00 1 066000061

6600 M/62

assortment of 28 tools,
with hooks without panel



6600 M/62 € 556,00 1 066000062

6600 M/63

assortment of 110 tools
with hooks without panel

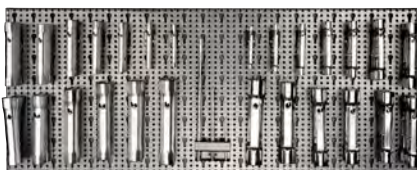

6600 M/63 € 2.150,00 1 066000063

6600 M/73

assortment of 68 tools
with hooks without panel



6600 M/73 € 1.400,00 1 066000073

6600 M/112

assortment of 329 tools,
with hooks without panel



6600 M/112 € 2.390,00 1 066000112

6600 M/116

assortment of 306 tools,
with hooks without panel



6600 M/116 € 2.240,00 1 066000116

6600 M/120

assortment of 163 tools,
with hooks without panel



6600 M/120 € 1.625,00 1 066000120

6600 M/125

assortment of 133 tools,
with hooks without panel



6600 M/125 € 1.405,00 1 066000125

6600 M/126

assortment of 58 tools,
with hooks without panel



6600 M/126 € 862,00 1 066000126

6600 M/131

assortment of 92 tools,
with hooks without panel



6600 M/131 € 2.680,00 1 066000131

6600 M/174

assortment of 13 tools, with hooks without
panel



6600 M/174 € 3.980,00 1 066000174

6600 M/175

assortment of 12 tools,
with hooks without panel



6600 M/175 € 2.830,00 1 066000175

6600 M/217

assortment of 74 tools,
with hooks without panel



6600 M/217 € 2.520,00 1 066000217

6600 M/218

assortment of 58 tools,
with hooks without panel



6600 M/218 € 1.325,00 1 066000218

6600 M/222

assortment of 74 tools,
with hooks without panel



6600 M/222 € 2.045,00 1 066000222

6600 M/223

assortment of 58 tools,
with hooks without panel

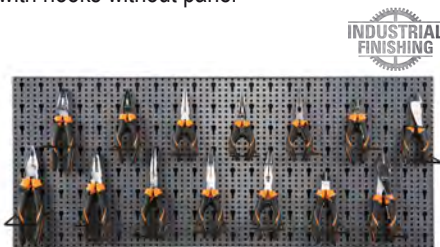

6600 M/223 € 1.730,00 1 066000223

6600 M/230

assortment of 78 tools,
with hooks without panel



6600 M/230 € 2.240,00 1 066000230

6600 M/236

assortment of 31 tools,
with hooks without panel



6600 M/236 € 1.260,00 1 066000236

6600 M/241

assortment of 43 tools,
with hooks without panel



6600 M/241 € 1.083,00 1 066000241

6600 M/242

assortment of 91 tools,
with hooks without panel



6600 M/242 € 2.610,00 1 066000242

6600 M/253

assortment of 60 tools,
with hooks without panel



6600 M/253 € 1.850,00 1 066000253

6600 M/311

assortment of 114 tools,
with hooks without panel



6600 M/311 € 1.071,00 1 066000311

6600 M/315

assortment of 149 tools,
with hooks without panel



6600 M/315 € 1.760,00 1 066000315

6600 M/320

assortment of 98 tools,
with hooks without panel



6600 M/320 € 1.605,00 1 066000320

6600 M/326

assortment of 155 tools,
with hooks without panel



6600 M/326 € 1.275,00 1 066000326

6600 M/327

assortment of 101 tools,
with hooks without panel

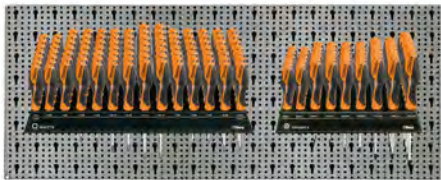

6600 M/327 € 1.045,00 1 066000327

6600 M/330

assortment of 110 tools,
with hooks without panel



6600 M/330 € 858,00 1 066000330

6600 M/371

assortment of 162 tools,
with hooks without panel



6600 M/371 € 1.064,00 1 066000371

6600 M/380

assortment of 71 tools,
with hooks without panel



6600 M/380 € 667,00 1 066000380

6600 M/406

assortment of 107 tools,
with hooks without panel



6600 M/406 € 1.126,00 1 066000406

6600 M/417

assortment of 43 tools,
with hooks without panel



6600 M/417 € 966,00 1 066000417

6600 M/423

assortment of 30 tools, with hooks without
panel



6600 M/423 € 965,00 1 066000423

6600 M/424

assortment of 36 tools, with hooks without
panel



6600 M/424 € 1.019,00 1 066000424

6600 M/427

assortment of 24 tools,
with hooks without panel



6600 M/427 € 1.042,00 1 066000427

6600 M/430

assortment of 29 tools,
with hooks without panel



6600 M/430 € 1.015,00 1 066000430

6600 M/440

assortment of 140 tools,
with hooks without panel

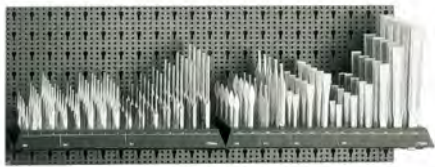

6600 M/440 € 1.935,00 1 066000440

6600 M/456

assortment of 41 tools,
with hooks without panel



6600 M/456 € 1.585,00 1 066000456

6600 M/465

assortment of 36 tools, with hooks without
panel



6600 M/465 € 2.000,00 1 066000465

6600 M/480

assortment of 18 tools,
with hooks without panel



6600 M/480 € 1.154,00 1 066000480

6600 M/485

assortment of 12 tools,
with hooks without panel



6600 M/485 € 828,00 1 066000485

6600 M/510

assortment of 16 tools,
with hooks without panel



6600 M/510 € 1.104,00 1 066000510

6600 M/532

assortment of 24 tools
with hooks without panel



6600 M/532 € 901,00 1 066000532

6600 M/534

assortment of 51 tools,
with hooks without panel



6600 M/534 € 1.455,00 1 066000534

6600 M/542

assortment of 53 tools,
with hooks without panel



6600 M/542 € 894,00 1 066000542

6600 M/548

assortment of 37 tools,
with hooks without panel



6600 M/548 € 824,00 1 066000548

6600 M/561

assortment of 60 tools,
with hooks without panel



6600 M/561 € 1.181,00 1 066000561

6600 M/583

assortment of 22 tools
with hooks without panel



6600 M/583 € 874,00 1 066000583

6600 M/643

assortment of 90 tools,
with hooks without panel



6600 M/643 € 1.985,00 1 066000643

6600 M/650

assortment of 28 tools,
with hooks without panel



6600 M/650 € 2.410,00 1 066000650

6600 M/657

assortment of 17 tools,
with hooks without panel



6600 M/657 € 1.955,00 1 066000657

6600 M/658

assortment of 14 tools
with hooks without panel

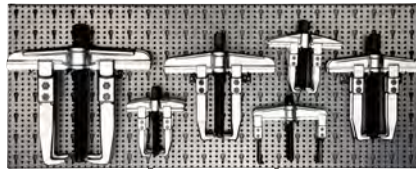

6600 M/658 € 2.185,00 1 066000658

6600 M/716

assortment of 64 tools,
with hooks without panel



6600 M/716 € 2.445,00 1 066000716

6600 M/813

assortment of 25 tools, with hooks without
panel



6600 M/813 € 1.113,00 1 066000813

6600 M/842

assortment of 36 tools, with hooks without
panel



6600 M/842 € 1.455,00 1 066000842

6600 M/852

assortment of 560 hard abrasive discs,
with hooks without panel



6600 M/852 € 1.103,00 1 066000852

6600 M/856

assortment of 560 hard abrasive discs,
with hooks without panel



6600 M/856 € 1.158,00 1 066000856

6600 M/857

assortment of 560 hard abrasive discs,
with hooks without panel



6600 M/857 € 1.191,00 1 066000857

6600 M/871

assortment of 120 abrasives
with hooks without panel



6600 M/871 € 534,00 1 066000871



6600 M/878

assortment of 100 abrasives
with hooks without panel



6600 M/878 € 494,00 1 066000878

6600 M/881

assortment of 410 abrasives
with display tray



6600 M/881 € 1.605,00 1 066000881



8600 R/11

assortment of 374 wire rope accessories, with
hooks without panel



8600 R/11 € 1.445,00 1 086000011

8600 R/12

assortment of 259 wire rope accessories,
with hooks without panel

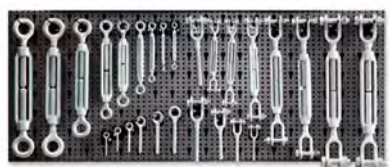

8600 R/12 € 1.470,00 1 086000012

8600 R/13

assortment of 230 wire rope accessories,
with hooks without panel



8600 R/13 € 1.225,00 1 086000013

8600 R/113

assortment of 1862 wire rope accessories,
with hooks without panel



8600 R/113 € 1.665,00 1 086000113

8600 R/114

assortment of 1045 wire rope accessories,
with hooks without panel



8600 R/114 € 1.670,00 1 086000114

8600 R/225

assortment of 64 GRADE 8 accessories,
with hooks without panel



8600 R/225 € 1.200,00 1 086000225

8600 R/412

assortment of 348 STAINLESS STEEL wire
rope accessories,
with hooks without panel

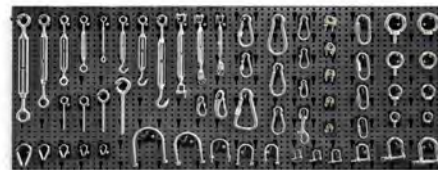

8600 R/412 € 1.680,00 1 086000412

8600 R/511

assortment of 11 Genovese chain reels,
with display tray



8600 R/511 € 1.390,00 1 086000511

8600 R/601

assortment of 50 tie down ratchets
with grids, shelf and hooks,
without panel



8600 R/601 € 1.390,00 1 086000601
C88/R601 € 286,00 1 088000160

8600 R/611

assortment of 52 webslings
with grids, without panel



8600 R/611 € 1.053,00 1 086000611
C88/R611 € 179,50 1 088000161



SAFETY FOOTWEAR

STANDARDS AND CLASSES

WARNINGS

Before use make, sure that the footwear meets your use requirements and has a proper protection class, according to type and workplace. The footwear manufactured by Beta Utensili complies with current EUROPEAN STANDARDS.

The employer shall ensure that suitable personal protective equipment is provided to the employees who may be exposed to a risk (characteristics and category of PPE).

EUROPEAN STANDARDS AND MEANINGS

COMPLIANCE WITH EN ISO 20344:2011

This standard specifies the test methods for footwear designed as PPE.

COMPLIANCE WITH EN ISO 20345:2011

This standard specifies basic and additional (optional) requirements for Safety Footwear for general purpose.

Footwear according to EN ISO 20345:2011 is marked "S" (= Safety), with toe caps resistant to an impact of 200 Joules.

COMPLIANCE WITH EN ISO 20346:2014

This standard specifies basic and additional (optional) requirements for Protective Footwear. Footwear according to EN ISO 20346:2011 is marked "P" (=Protective), with toe caps resistant to an impact of 100 Joules.

COMPLIANCE WITH EN ISO 20347:2012

This standard specifies basic and additional (optional) requirements for occupational footwear that is not exposed to any mechanical risks (impact or compression). Footwear according to EN ISO 20347:2012 is marked "O" (= Occupational). It shares quite the same characteristics as the above footwear, although neither toe caps nor penetration-proof insoles are required.

As well as the basic requirements under EN ISO 20345:2011, footwear may also meet some additional requirements, which must be identified with symbols or classes and stated on the label applied to the tongue of the footwear.

CONFORMITY MARKING OF FOOTWEAR

- Mark: CE
- Footwear size: 42
- Name and address of manufacturer: Beta Utensili S.p.A. Via Volta, 18 20845 Sovico (MB) – Italy
- Date of production (month/year): 01/20
- Reference to international standard: EN ISO 20345:2011
- Protection class: S3

CLASSIFICATION

I = Footwear made from leather and other materials, excluding rubber or polymeric footwear

II = All-rubber or all-polymeric footwear (boots)

CLASS AND REQUIREMENTS

SB (I) Basic requirements

- Toe cap resistant to an **impact** of 200 Joules
- Outsole **slip** resistance (SRA and/or SRB)
- Minimum upper **height**
- One additional footwear requirement

S1 (I) Basic requirements plus:

- Closed **seat** region
- **Antistatic** properties (A)
- **Energy absorption** of seat region (E)

S2 (I) S1 requirements plus:

- Water penetration and **water absorption** resistant upper (WRU)

S3 (I) S2 requirements plus:

- **Penetration** resistance (P)
- **Cleated** outsole

S4 (II) SB requirements plus:

- **Antistatic** properties (A)
- **Energy absorption** of seat region (E)

S5 (II) S4 requirements plus:

- **Penetration** resistance (P)
- **Cleated** outsole

SHELF LIFE

Due to several factors (storage humidity and modification of the structure of materials over time), the shelf life of footwear cannot be determined with certainty. Generally speaking, footwear with outsoles made entirely from polyurethane or with polyurethane bottoms are expected to have a shelf life of three years; whereas the other types of footwear are expected to have a shelf life of five years. Such shelf lives are applicable to new, packed footwear stored under controlled conditions – that is, avoiding sudden changes in temperature and relative humidity.

BASIC REQUIREMENTS + ADDITIONAL REQUIREMENTS FOR FOOTWEAR

PROTECTION CLASS	EN ISO 20345:2011				EN ISO 20347:2012				EN ISO 20345:2011		EN ISO 20347:2012		MINIMUM REQUIRED VALUES	
	SB	S1	S2	S3	OB	O1	O2	O3	S4	S5	O4	O5		
	Closed seat region	O	X	X	X	O	X	X	X	X	X	X	X	
	Toe cap resistant to an impact of 200 Joules	X	X	X	X	-	-	-	-	X	X	-	-	
A	Antistatic footwear	O	X	X	X	O	X	X	X	X	X	X	X	Electrical resistance >100 kΩ, ≤1000 MΩ
E	Energy absorption of seat region	O	X	X	X	O	X	X	X	X	X	X	X	> 20 Joules
WRU	Water penetration and resistance of upper	O	-	X	X	O	-	X	X	-	-	-	-	Penetration: <0.2 g x 60 min Absorption: < 30% x 60 min.
P	Penetration resistance of outsole	O	O	-	X	O	O	-	X	O	X	O	X	> 1100 N
CI	Cold insulation	O	O	O	O	O	O	O	O	O	O	O	O	Temp. decrease of inner surface of sole: < 10° C
HI	Heat insulation	O	O	O	O	O	O	O	O	O	O	O	O	Temp. increase of inner surface of sole: < 22° C
C	Conductive footwear	O	-	-	-	O	-	-	-	-	-	-	-	< 100 kΩ
HRO	Heat resistance of outsole	O	O	O	O	O	O	O	O	O	O	O	O	Resistant up to 300°
AN	Ankle protection	O	O	O	O	O	O	O	O	O	O	O	O	Mean value <10 kN; Individual values <15 kN
I	Electrically insulating footwear	O	-	-	-	O	-	-	-	-	-	-	-	Electrical class: 00 ÷ 500 V a.c. Electrical class: 0 ÷ 1000 V a.
WR	Water resistance	O	O	O	O	O	O	O	O	-	-	-	-	Absorption: < 3 cm ²
M	Metatarsal protection (only for EN ISO 20345:2011)	O	O	O	O	-	-	-	-	O	O	-	-	Free height after impact ≥ 40 mm. (size 41/42)
CR	Cut resistance of upper (only for EN ISO 20345:2011) (other than model A)	O	O	O	O	-	-	-	-	O	O	-	-	Cut resistance index ≥ 2,5
FO	Fuel oil resistance of outsole	O	X	X	X	O	O	O	O	X	X	O	O	Outsole volume increase < 12%
WG	Protection against molten metal splashes as found in foundries and welding	-	-	-	-	-	-	-	-	-	-	-	-	Min. 25 drops to get to a temperature of 40° C
SRC	Slip resistance of outsole	X	X	X	X	X	X	X	X					SRA + SRB requirement

X	Mandatory requirement for protection class
O	Optional requirement added to mandatory ones, if marked on marking
-	Not mandatory requirement, check footwear stamping

Antistatic footwear:

Antistatic footwear must be used when there is the need to minimize the accumulation of electrostatic charges, so as to rule out the danger of combustion of flammable substances and vapours and in case the risk of electric shocks from live parts should persist. Antistatic footwear does not provide protection against electric shock, as it only creates an electrical resistance between the floor and the foot. If the danger of electric shock cannot be completely ruled out, additional precautions must be taken as part of a periodic plan for accident prevention in the workplace. For antistatic requirements to be met, the footwear must not be modified.

Insulating footwear:

Insulating footwear provide electrical protection against accidental contacts with voltages up to 1000 V, provided that usage conditions are such as not to modify or alter electrical resistance under the influence of humidity. It should be pointed out that electrical resistance

only refers to the bottom, and not to the upper, of the footwear.

Electrical classes for footwear:

Class 00 500V CA or 750V CC

Class 0 1000V CA or 1500V CC

Dissipative footwear for EPA environments:



Dissipative footwear, which is specially designed for EPA (ESDS) environments, allows electrostatic charges to be dissipated from the wearer's body in a continuous and controlled way, so as to protect electronic components and devices from electrostatic phenomena. The reference value of ground resistance according to CEI EN 61340-5-1: 2016, for wearer/footwear/floor, is <1 × 10⁹ Ω.

EN ISO 20345:2011		S1P SRC									
LINE	ITEM	REQUIREMENTS		RECOMMENDED SECTORS						📄	
		ADDITIONAL REQUIREMENTS			AUTOMOTIVE	BUILDING	ELECTRICITY	INDUSTRY	SERVICE LOGISTICS		EATING & PLUMBING
BASIC PLUS 	7210BKK			X	X	X	X	X	X	X	574
	7216BKK			X	X	X	X	X	X	X	574
FLEX 	7212FG			X	X		X	X	X	X	571
	7213FG			X	X		X	X	X	X	571
FLEX LADY 	7212LG			X	X		X	X	X	X	571
FLEX EVOLUTION 	7217FG			X	X		X	X	X	X	572
EASY PLUS 	7222PEK			X	X	X	X	X	X	X	569
	7223PEK			X	X	X	X	X	X	X	570
	7224PEK			X	X	X	X	X	X	X	570
	7225PEK			X	X	X	X	X	X	X	570
BASIC 	7241BK				X	X	X	X	X	X	566
	7243BK				X	X	X	X	X	X	566
	7246BK				X	X	X	X	X	X	568
	7247BK				X	X	X	X	X	X	568
EASY 	7246E				X		X	X	X	X	565
TREKKING 	7248GK				X		X	X	X	X	576
	7249GK	RS			X		X		X	X	576
SNEAKERS 	7314AF			X	X	X	X	X	X	X	577
	7317NA			X	X	X	X	X	X	X	578
SNEAKERS PRO 	7340B				X		X	X	X	X	583
	7340R				X		X	X	X	X	583
0-GRAVITY 	7352A	HRO		X	X		X	X	X	X	579
	7352B	HRO		X	X		X	X	X	X	579
	7353Y	HRO			X		X	X	X	X	580
	7352G	HRO		X	X		X	X	X	X	580
0-GRAVITY LADY 	7352LG	HRO		X	X		X	X	X	X	580

EN ISO 20347:2012		O1 SRC									
0-GRAVITY 	7362B	FO HRO		X	X		X	X			582



EN ISO 20345:2011		S3 SRC										
LINE	ITEM	REQUIREMENTS		RECOMMENDED SECTORS						📄		
		ADDITIONAL REQUIREMENTS			AGRICULTURE	AUTOMOTIVE	BUILDING	INDUSTRY	ELECTRICITY		SERVICE LOGISTICS	OIL & GAS
BASIC PLUS 	7200BKK			X	X	X	X	X	X	X	X	573
	7201BKK			X	X	X	X	X	X	X	X	574
	7310CRK	RS HRO			X	X	X	X			X	574
FLEX 	7214FN			X		X		X	X	X	X	572
	7215FN			X		X		X	X	X	X	572
	7218FN	RS		X		X		X	X	X	X	573
FLEX LADY 	7214LN			X		X		X	X	X	X	572
FLEX EVOLUTION 	7219FY			X		X		X	X	X	X	573
EASY PLUS 	7220PEK			X	X	X	X	X	X	X	X	569
	7221PEK	RS		X	X	X	X	X	X	X	X	569
TREKKING 	7235BK				X		X	X		X	X	575
	7236BK	RS			X		X	X			X	575
	7238WR	RS HRO WR			X		X	X			X	575
EASY 	7241EN				X		X	X		X	X	565
	7243EN	RS			X		X	X			X	565
BASIC 	7241CK				X	X	X	X		X	X	566
	7243CK	RS			X	X	X	X			X	567
	7243CR	RS HRO			X		X	X		X	X	567
	7245BK	RS			X	X	X	X			X	567
HEAVY DUTY 	7293HM	HRO HI	X		X	X				X	X	584
	7293HN	HRO HI	X		X	X				X	X	585
	7294HM	HRO HI	X		X	X				X	X	585
	7294HMC	HRO HI CI WR	X		X	X				X	X	585
	7294HN	RS HRO HI	X		X	X				X	X	585
SNEAKERS 	7315AN			X		X	X	X	X	X	X	577
	7318AN			X		X	X	X	X	X	X	577
	7320NA			X	X	X	X	X	X	X	X	578
	7321NA	RS		X	X	X	X	X	X	X	X	578
	7322SA			X	X	X	X	X	X	X	X	578
	7323SA	RS		X	X	X	X	X	X	X	X	579
SNEAKERS PRO 	7341N				X		X	X		X	X	583
	7349RP	HRO		X	X	X	X	X	X	X	X	584
	7350RP	HRO		X	X	X	X	X	X	X	X	584
0-GRAVITY 	7354N	HRO		X	X		X	X	X	X	X	580
	7355V	HRO		X	X		X	X	X	X	X	581
	7356G	HRO		X	X		X	X	X	X	X	581
	7357G	HRO		X	X		X	X	X	X	X	582
	7356V	HRO		X	X		X	X	X	X	X	581
	7357V	HRO		X	X		X	X	X	X	X	582
0-GRAVITY LADY 	7356LN	HRO		X	X		X	X	X	X	X	581

EN ISO 20347:2012		O2 SRC										
BASIC 	7243FT	FO			X	X		X			X	567
0-GRAVITY 	7363N	FO HRO			X		X		X	X		582

EN ISO 20345:2011		S5 SRC										
BASIC 	7328EA				X	X	X			X	X	568
	7328EN				X	X	X			X	X	568

EASY



7241EN

leather shoe, water-repellent

- Steel toe cap
- Elastic steel penetration proof insole

EU	UK	€		
35	2,5	36,50	1	072410835
36	3,5	36,50	1	072410836
37	4,5	36,50	1	072410837
38	5	36,50	1	072410838
39	6	36,50	1	072410839
40	6,5	36,50	1	072410840
41	7	36,50	1	072410841
42	8	36,50	1	072410842
43	9	36,50	1	072410843
44	10	36,50	1	072410844
45	10,5	36,50	1	072410845
46	11	36,50	1	072410846
47	12	36,50	1	072410847
48	13	36,50	1	072410848



CE

S3 SRC

EN ISO 20345 2011



7243EN

leather ankle shoe, water-repellent, with quick opening system

- Steel toe cap
- Elastic steel penetration proof insole

EU	UK	€		
35	2,5	37,50	1	072430835
36	3,5	37,50	1	072430836
37	4,5	37,50	1	072430837
38	5	37,50	1	072430838
39	6	37,50	1	072430839
40	6,5	37,50	1	072430840
41	7	37,50	1	072430841
42	8	37,50	1	072430842
43	9	37,50	1	072430843
44	10	37,50	1	072430844
45	10,5	37,50	1	072430845
46	11	37,50	1	072430846
47	12	37,50	1	072430847
48	13	37,50	1	072430848



CE

S3 RS SRC

EN ISO 20345 2011



7246E

suede shoe, perforated

- Steel toe cap
- Elastic steel penetration proof insole

EU	UK	€		
35	2,5	37,50	1	072460435
36	3,5	37,50	1	072460436
37	4,5	37,50	1	072460437
38	5	37,50	1	072460438
39	6	37,50	1	072460439
40	6,5	37,50	1	072460440
41	7	37,50	1	072460441
42	8	37,50	1	072460442
43	9	37,50	1	072460443
44	10	37,50	1	072460444
45	10,5	37,50	1	072460445
46	11	37,50	1	072460446
47	12	37,50	1	072460447
48	13	37,50	1	072460448



CE

S1P SRC

EN ISO 20345 2011



BASIC



7241BK

leather shoe

- Steel toe cap
- Composite fibre penetration proof insole

EU	UK	€		
35	2,5	43,50	1	072411235
36	3,5	43,50	1	072411236
37	4,5	43,50	1	072411237
38	5	43,50	1	072411238
39	6	43,50	1	072411239
40	6,5	43,50	1	072411240
41	7	43,50	1	072411241
42	8	43,50	1	072411242
43	9	43,50	1	072411243
44	10	43,50	1	072411244
45	10,5	43,50	1	072411245
46	11	43,50	1	072411246
47	12	43,50	1	072411247
48	13	43,50	1	072411248



CE

S1P SRC

EN ISO
20345
2011



7241CK

leather shoe, water-repellent

- Steel toe cap
- Composite fibre penetration proof insole

EU	UK	€		
35	2,5	44,50	1	072411535
36	3,5	44,50	1	072411536
37	4,5	44,50	1	072411537
38	5	44,50	1	072411538
39	6	44,50	1	072411539
40	6,5	44,50	1	072411540
41	7	44,50	1	072411541
42	8	44,50	1	072411542
43	9	44,50	1	072411543
44	10	44,50	1	072411544
45	10,5	44,50	1	072411545
46	11	44,50	1	072411546
47	12	44,50	1	072411547
48	13	44,50	1	072411548



CE

S3 SRC

EN ISO
20345
2011



7243BK

leather ankle shoe

- Steel toe cap
- Composite fibre penetration proof insole

EU	UK	€		
35	2,5	44,50	1	072431235
36	3,5	44,50	1	072431236
37	4,5	44,50	1	072431237
38	5	44,50	1	072431238
39	6	44,50	1	072431239
40	6,5	44,50	1	072431240
41	7	44,50	1	072431241
42	8	44,50	1	072431242
43	9	44,50	1	072431243
44	10	44,50	1	072431244
45	10,5	44,50	1	072431245
46	11	44,50	1	072431246
47	12	44,50	1	072431247
48	13	44,50	1	072431248



CE

S1P SRC

EN ISO
20345
2011



7243CK

leather ankle shoe, water-repellent,
with quick opening system

- Steel toe cap
- Composite fibre penetration proof insole

EU	UK	€		
35	2,5	45,50	1	072431335
36	3,5	45,50	1	072431336
37	4,5	45,50	1	072431337
38	5	45,50	1	072431338
39	6	45,50	1	072431339
40	6,5	45,50	1	072431340
41	7	45,50	1	072431341
42	8	45,50	1	072431342
43	9	45,50	1	072431343
44	10	45,50	1	072431344
45	10,5	45,50	1	072431345
46	11	45,50	1	072431346
47	12	45,50	1	072431347
48	13	45,50	1	072431348

CE



S3 RS SRC

EN ISO
20345
2011



7243CR

leather ankle shoe, waterproof,
with durable rubber outsole
and quick opening system

- Steel toe cap
- Elastic steel penetration-proof insole

EU	UK	€		
35	2,5	67,00	1	072430735
36	3,5	67,00	1	072430736
37	4,5	67,00	1	072430737
38	5	67,00	1	072430738
39	6	67,00	1	072430739
40	6,5	67,00	1	072430740
41	7	67,00	1	072430741
42	8	67,00	1	072430742
43	9	67,00	1	072430743
44	10	67,00	1	072430744
45	10,5	67,00	1	072430745
46	11	67,00	1	072430746
47	12	67,00	1	072430747
48	13	67,00	1	072430748

CE



S3 RS HRO SRC

EN ISO
20345
2011



7243FT

leather ankle shoe, waterproof,
without toe cap and penetration proof insole

- Without toe cap
- Without penetration proof insole

EU	UK	€		
35	2,5	39,50	1	072430635
36	3,5	39,50	1	072430636
37	4,5	39,50	1	072430637
38	5	39,50	1	072430638
39	6	39,50	1	072430639
40	6,5	39,50	1	072430640
41	7	39,50	1	072430641
42	8	39,50	1	072430642
43	9	39,50	1	072430643
44	10	39,50	1	072430644
45	10,5	39,50	1	072430645
46	11	39,50	1	072430646
47	12	39,50	1	072430647
48	13	39,50	1	072430648

CE



O2 FO SRC

EN ISO
20347
2012



7245BK

lace-up leather ankle shoe, "welder" style, water-repellent, with
quick opening system
and front protection with strap closure

- Steel toe cap
- Composite fibre penetration proof insole

EU	UK	€		
35	2,5	52,50	1	072451235
36	3,5	52,50	1	072451236
37	4,5	52,50	1	072451237
38	5	52,50	1	072451238
39	6	52,50	1	072451239
40	6,5	52,50	1	072451240
41	7	52,50	1	072451241
42	8	52,50	1	072451242
43	9	52,50	1	072451243
44	10	52,50	1	072451244
45	10,5	52,50	1	072451245
46	11	52,50	1	072451246
47	12	52,50	1	072451247
48	13	52,50	1	072451248

CE



S3 RS SRC

EN ISO
20345
2011



7246BK
suede shoe, perforated

- Steel toe cap
- Composite fibre penetration proof insole

EU	UK	€	W	L
35	2,5	45,50	1	072461235
36	3,5	45,50	1	072461236
37	4,5	45,50	1	072461237
38	5	45,50	1	072461238
39	6	45,50	1	072461239
40	6,5	45,50	1	072461240
41	7	45,50	1	072461241
42	8	45,50	1	072461242
43	9	45,50	1	072461243
44	10	45,50	1	072461244
45	10,5	45,50	1	072461245
46	11	45,50	1	072461246
47	12	45,50	1	072461247
48	13	45,50	1	072461248

CE



S1P SRC



7247BK
leather sandal, perforated

- Steel toe cap
- Composite fibre penetration proof insole

EU	UK	€	W	L
35	2,5	45,00	1	072471235
36	3,5	45,00	1	072471236
37	4,5	45,00	1	072471237
38	5	45,00	1	072471238
39	6	45,00	1	072471239
40	6,5	45,00	1	072471240
41	7	45,00	1	072471241
42	8	45,00	1	072471242
43	9	45,00	1	072471243
44	10	45,00	1	072471244
45	10,5	45,00	1	072471245
46	11	45,00	1	072471246
47	12	45,00	1	072471247
48	13	45,00	1	072471248

CE



S1P SRC



7328EA
safety boot, "Top Visibility"

- Steel toe cap
- Stainless steel penetration proof insole

EU	UK	€	W	L
38	5	37,00	1	073280538
39	6	37,00	1	073280539
40	6,5	37,00	1	073280540
41	7	37,00	1	073280541
42	8	37,00	1	073280542
43	9	37,00	1	073280543
44	10	37,00	1	073280544
45	10,5	37,00	1	073280545
46	11	37,00	1	073280546
47	12	37,00	1	073280547

CE



S5 SRC



7328EN
safety boot

- Steel toe cap
- Stainless steel penetration proof insole

EU	UK	€	W	L
38	5	37,00	1	073280738
39	6	37,00	1	073280739
40	6,5	37,00	1	073280740
41	7	37,00	1	073280741
42	8	37,00	1	073280742
43	9	37,00	1	073280743
44	10	37,00	1	073280744
45	10,5	37,00	1	073280745
46	11	37,00	1	073280746
47	12	37,00	1	073280747

CE



S5 SRC



EASY PLUS



7220PEK

leather shoe, water-repellent, with nylon inserts and anti-abrasion reinforcement in toe cap area

- Composite toe cap
- Composite fibre penetration proof insole

EU	UK	€		
35	2,5	60,00	1	072200235
36	3,5	60,00	1	072200236
37	4,5	60,00	1	072200237
38	5	60,00	1	072200238
39	6	60,00	1	072200239
40	6,5	60,00	1	072200240
41	7	60,00	1	072200241
42	8	60,00	1	072200242
43	9	60,00	1	072200243
44	10	60,00	1	072200244
45	10,5	60,00	1	072200245
46	11	60,00	1	072200246
47	12	60,00	1	072200247
48	13	60,00	1	072200248

CE



S3 SRC

EN ISO 20345 2011



7221PEK

leather ankle shoe, water-repellent, with nylon inserts, anti-abrasion reinforcement in toe cap area and quick opening system

- Composite toe cap
- Composite fibre penetration proof insole

EU	UK	€		
35	2,5	62,50	1	072210235
36	3,5	62,50	1	072210236
37	4,5	62,50	1	072210237
38	5	62,50	1	072210238
39	6	62,50	1	072210239
40	6,5	62,50	1	072210240
41	7	62,50	1	072210241
42	8	62,50	1	072210242
43	9	62,50	1	072210243
44	10	62,50	1	072210244
45	10,5	62,50	1	072210245
46	11	62,50	1	072210246
47	12	62,50	1	072210247
48	13	62,50	1	072210248

CE



S3 RS SRC

EN ISO 20345 2011



7222PEK

suede shoe, perforated, with highly breathable mesh inserts

- Composite toe cap
- Composite fibre penetration proof insole

EU	UK	€		
35	2,5	57,50	1	072220135
36	3,5	57,50	1	072220136
37	4,5	57,50	1	072220137
38	5	57,50	1	072220138
39	6	57,50	1	072220139
40	6,5	57,50	1	072220140
41	7	57,50	1	072220141
42	8	57,50	1	072220142
43	9	57,50	1	072220143
44	10	57,50	1	072220144
45	10,5	57,50	1	072220145
46	11	57,50	1	072220146
47	12	57,50	1	072220147
48	13	57,50	1	072220148

CE



S1P SRC

EN ISO 20345 2011



7223PEK

suede shoe with highly breathable mesh inserts and anti-abrasion reinforcement in toe cap area

- Composite toe cap
- Composite fibre penetration proof insole

EU	UK	€	W	L
35	2,5	62,00	1	072230135
36	3,5	62,00	1	072230136
37	4,5	62,00	1	072230137
38	5	62,00	1	072230138
39	6	62,00	1	072230139
40	6,5	62,00	1	072230140
41	7	62,00	1	072230141
42	8	62,00	1	072230142
43	9	62,00	1	072230143
44	10	62,00	1	072230144
45	10,5	62,00	1	072230145
46	11	62,00	1	072230146
47	12	62,00	1	072230147
48	13	62,00	1	072230148

CE



S1P SRC



7224PEK

suede shoe, perforated, with anti-abrasion reinforcement in toe cap area

- Composite toe cap
- Composite fibre penetration proof insole

EU	UK	€	W	L
35	2,5	62,00	1	072240235
36	3,5	62,00	1	072240236
37	4,5	62,00	1	072240237
38	5	62,00	1	072240238
39	6	62,00	1	072240239
40	6,5	62,00	1	072240240
41	7	62,00	1	072240241
42	8	62,00	1	072240242
43	9	62,00	1	072240243
44	10	62,00	1	072240244
45	10,5	62,00	1	072240245
46	11	62,00	1	072240246
47	12	62,00	1	072240247
48	13	62,00	1	072240248

CE



S1P SRC



7225PEK

suede shoe, perforated

- Composite toe cap
- Composite fibre penetration proof insole

EU	UK	€	W	L
35	2,5	59,50	1	072250135
36	3,5	59,50	1	072250136
37	4,5	59,50	1	072250137
38	5	59,50	1	072250138
39	6	59,50	1	072250139
40	6,5	59,50	1	072250140
41	7	59,50	1	072250141
42	8	59,50	1	072250142
43	9	59,50	1	072250143
44	10	59,50	1	072250144
45	10,5	59,50	1	072250145
46	11	59,50	1	072250146
47	12	59,50	1	072250147
48	13	59,50	1	072250148

CE



S1P SRC

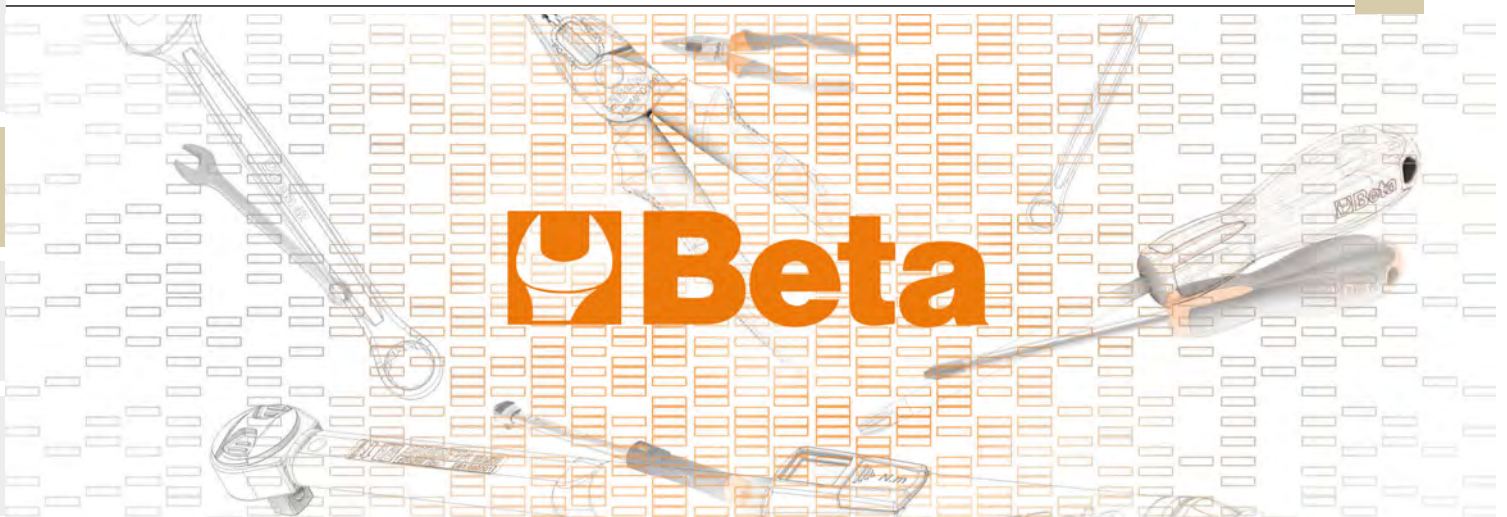

FLEX



7212FG

suede shoe, perforated, with anti-abrasion insert in toe cap area
Extremely flexible and lightweight - approximate weight, size 42: 490 g
Not recommended for heavy-duty use (building, agriculture, heavy industry)

- Composite toe cap
- Composite fibre penetration-proof insole

EU	UK	€	☞	☞
35	2,5	66,00	1	072120035
36	3,5	66,00	1	072120036
37	4,5	66,00	1	072120037
38	5	66,00	1	072120038
39	6	66,00	1	072120039
40	6,5	66,00	1	072120040
41	7	66,00	1	072120041
42	8	66,00	1	072120042
43	9	66,00	1	072120043
44	10	66,00	1	072120044
45	10,5	66,00	1	072120045
46	11	66,00	1	072120046
47	12	66,00	1	072120047
48	13	66,00	1	072120048



EN ISO 20345 2011



CE

S1P SRC

7212LG

women's suede shoe, perforated, with mesh inserts
Extremely flexible and lightweight - approximate weight, size 38: 380 g
Not recommended for heavy-duty use (building, agriculture, heavy industry)

- Composite toe cap
- Composite fibre penetration-proof insole

EU	UK	€	☞	☞
34	2	63,00	1	072120134
35	2,5	63,00	1	072120135
36	3,5	63,00	1	072120136
37	4,5	63,00	1	072120137
38	5	63,00	1	072120138
39	6	63,00	1	072120139
40	6,5	63,00	1	072120140
41	7	63,00	1	072120141
42	8	63,00	1	072120142



EN ISO 20345 2011



CE

S1P SRC

7213FG

suede shoe with highly breathable mesh inserts
Extremely flexible and lightweight - approximate weight, size 42: 490 g
Not recommended for heavy-duty use (building, agriculture, heavy industry)

- Composite toe cap
- Composite fibre penetration-proof insole

EU	UK	€	☞	☞
35	2,5	66,00	1	072130035
36	3,5	66,00	1	072130036
37	4,5	66,00	1	072130037
38	5	66,00	1	072130038
39	6	66,00	1	072130039
40	6,5	66,00	1	072130040
41	7	66,00	1	072130041
42	8	66,00	1	072130042
43	9	66,00	1	072130043
44	10	66,00	1	072130044
45	10,5	66,00	1	072130045
46	11	66,00	1	072130046
47	12	66,00	1	072130047
48	13	66,00	1	072130048



EN ISO 20345 2011



CE

S1P SRC

7214FN

Action nubuck shoe, waterproof, with anti-abrasion insert in toe cap area
Extremely flexible and lightweight - approximate weight size 42: 500 g
Not recommended for heavy-duty use (building, agriculture, heavy industry)

- Composite toe cap
- Composite fibre penetration-proof insole

EU	UK	€		
35	2,5	71,50	1	072140035
36	3,5	71,50	1	072140036
37	4,5	71,50	1	072140037
38	5	71,50	1	072140038
39	6	71,50	1	072140039
40	6,5	71,50	1	072140040
41	7	71,50	1	072140041
42	8	71,50	1	072140042
43	9	71,50	1	072140043
44	10	71,50	1	072140044
45	10,5	71,50	1	072140045
46	11	71,50	1	072140046
47	12	71,50	1	072140047
48	13	71,50	1	072140048



CE

S3 SRC



7214LN

women's suede shoe, waterproof, with anti-abrasion insert in toe cap area
Extremely flexible and lightweight - approximate weight, size 38: 380 g
Not recommended for heavy-duty use (building, agriculture, heavy industry)

- Composite toe cap
- Composite fibre penetration-proof insole

EU	UK	€		
34	2	66,00	1	072140134
35	2,5	66,00	1	072140135
36	3,5	66,00	1	072140136
37	4,5	66,00	1	072140137
38	5	66,00	1	072140138
39	6	66,00	1	072140139
40	6,5	66,00	1	072140140
41	7	66,00	1	072140141
42	8	66,00	1	072140142



CE

S3 SRC



7215FN

Action nubuck moccasin, waterproof, with anti-abrasion insert in toe cap area
Extremely flexible and lightweight - approximate weight, size 42: 490 g
Not recommended for heavy-duty use (building, agriculture, heavy industry)

- Composite toe cap
- Composite fibre penetration-proof insole

EU	UK	€		
35	2,5	72,50	1	072150135
36	3,5	72,50	1	072150136
37	4,5	72,50	1	072150137
38	5	72,50	1	072150138
39	6	72,50	1	072150139
40	6,5	72,50	1	072150140
41	7	72,50	1	072150141
42	8	72,50	1	072150142
43	9	72,50	1	072150143
44	10	72,50	1	072150144
45	10,5	72,50	1	072150145
46	11	72,50	1	072150146
47	12	72,50	1	072150147
48	13	72,50	1	072150148



CE

S3 SRC



7217FG

mesh shoe, highly breathable, with anti-abrasion insert in toe cap area
Extremely flexible and lightweight - approximate weight, size 42: 490 g
Not recommended for heavy-duty jobs (building, agriculture, heavy industry)

- Composite toe cap
- Composite fibre penetration-proof insole

EU	UK	€		
35	2,5	75,00	1	072170235
36	3,5	75,00	1	072170236
37	4,5	75,00	1	072170237
38	5	75,00	1	072170238
39	6	75,00	1	072170239
40	6,5	75,00	1	072170240
41	7	75,00	1	072170241
42	8	75,00	1	072170242
43	9	75,00	1	072170243
44	10	75,00	1	072170244
45	10,5	75,00	1	072170245
46	11	75,00	1	072170246
47	12	75,00	1	072170247
48	13	75,00	1	072170248



CE

S1P SRC



7218FN

Action nubuck ankle shoe, water-repellent, with anti-abrasion insert in toe cap area and quick opening system
Extremely flexible and lightweight - approximate weight, size 42: 510 g
Not recommended for heavy-duty use (building, agriculture, heavy industry)

- Composite toe cap
- Composite fibre penetration proof insole

EU	UK	€	👤	📦
35	2,5	75,00	1	072180035
36	3,5	75,00	1	072180036
37	4,5	75,00	1	072180037
38	5	75,00	1	072180038
39	6	75,00	1	072180039
40	6,5	75,00	1	072180040
41	7	75,00	1	072180041
42	8	75,00	1	072180042
43	9	75,00	1	072180043
44	10	75,00	1	072180044
45	10,5	75,00	1	072180045
46	11	75,00	1	072180046
47	12	75,00	1	072180047
48	13	75,00	1	072180048

CE



S3 RS SRC

EN ISO
20345
2011



7219FY

microfibre shoe, waterproof, with anti-abrasion insert in toe cap area Extremely flexible and lightweight - approximate weight, size 42: 490 g Not recommended for heavy-duty jobs (building, agriculture, heavy industry)

- Composite toe cap
- Composite fibre penetration-proof insole

EU	UK	€	👤	📦
35	2,5	79,50	1	072190035
36	3,5	79,50	1	072190036
37	4,5	79,50	1	072190037
38	5	79,50	1	072190038
39	6	79,50	1	072190039
40	6,5	79,50	1	072190040
41	7	79,50	1	072190041
42	8	79,50	1	072190042
43	9	79,50	1	072190043
44	10	79,50	1	072190044
45	10,5	79,50	1	072190045
46	11	79,50	1	072190046
47	12	79,50	1	072190047
48	13	79,50	1	072190048

CE



S3 SRC

EN ISO
20345
2011



BASIC PLUS



7200BKK

full-grain leather shoe, waterproof

- Composite toe cap
- Composite fibre penetration proof insole

EU	UK	€	👤	📦
35	2,5	68,50	1	072000235
36	3,5	68,50	1	072000236
37	4,5	68,50	1	072000237
38	5	68,50	1	072000238
39	6	68,50	1	072000239
40	6,5	68,50	1	072000240
41	7	68,50	1	072000241
42	8	68,50	1	072000242
43	9	68,50	1	072000243
44	10	68,50	1	072000244
45	10,5	68,50	1	072000245
46	11	68,50	1	072000246
47	12	68,50	1	072000247
48	13	68,50	1	072000248

CE



S3 SRC

EN ISO
20345
2011



7201BKK

full-grain leather ankle shoe, waterproof

- Composite toe cap
- Composite fibre penetration proof insole

EU	UK	€	W	L
35	2,5	72,50	1	072010435
36	3,5	72,50	1	072010436
37	4,5	72,50	1	072010437
38	5	72,50	1	072010438
39	6	72,50	1	072010439
40	6,5	72,50	1	072010440
41	7	72,50	1	072010441
42	8	72,50	1	072010442
43	9	72,50	1	072010443
44	10	72,50	1	072010444
45	10,5	72,50	1	072010445
46	11	72,50	1	072010446
47	12	72,50	1	072010447
48	13	72,50	1	072010448

CE



S3 SRC



7210BKK

soft suede shoe, perforated

- Composite toe cap
- Composite fibre penetration proof insole

EU	UK	€	W	L
35	2,5	68,00	1	072100335
36	3,5	68,00	1	072100336
37	4,5	68,00	1	072100337
38	5	68,00	1	072100338
39	6	68,00	1	072100339
40	6,5	68,00	1	072100340
41	7	68,00	1	072100341
42	8	68,00	1	072100342
43	9	68,00	1	072100343
44	10	68,00	1	072100344
45	10,5	68,00	1	072100345
46	11	68,00	1	072100346
47	12	68,00	1	072100347
48	13	68,00	1	072100348

CE



S1P SRC



7216BKK

soft suede sandal, with strap closure

- Composite toe cap
- Composite fibre penetration proof insole

EU	UK	€	W	L
35	2,5	70,50	1	072160335
36	3,5	70,50	1	072160336
37	4,5	70,50	1	072160337
38	5	70,50	1	072160338
39	6	70,50	1	072160339
40	6,5	70,50	1	072160340
41	7	70,50	1	072160341
42	8	70,50	1	072160342
43	9	70,50	1	072160343
44	10	70,50	1	072160344
45	10,5	70,50	1	072160345
46	11	70,50	1	072160346
47	12	70,50	1	072160347
48	13	70,50	1	072160348

CE



S1P SRC



7310CRK

lace-up black leather shoe, "welder" style, water-repellent, with quick opening system and front protection with strap fastening and flameproof seams. Hard-wearing rubber outsole and anti-abrasion insert in toe cap area

- Composite toe cap
- Composite fibre penetration proof insole

EU	UK	€	W	L
35	2,5	81,50	1	073100335
36	3,5	81,50	1	073100336
37	4,5	81,50	1	073100337
38	5	81,50	1	073100338
39	6	81,50	1	073100339
40	6,5	81,50	1	073100340
41	7	81,50	1	073100341
42	8	81,50	1	073100342
43	9	81,50	1	073100343
44	10	81,50	1	073100344
45	10,5	81,50	1	073100345
46	11	81,50	1	073100346
47	12	81,50	1	073100347
48	13	81,50	1	073100348

CE



S3 RS HRO SRC



TREKKING



7235BK

Action Nubuck shoe, waterproof, with reinforcement polyurethane toe cap cover

- Steel toe cap
- Composite fibre penetration-proof insole

EU	UK	€		
35	2,5	65,50	1	072350335
36	3,5	65,50	1	072350336
37	4,5	65,50	1	072350337
38	5	65,50	1	072350338
39	6	65,50	1	072350339
40	6,5	65,50	1	072350340
41	7	65,50	1	072350341
42	8	65,50	1	072350342
43	9	65,50	1	072350343
44	10	65,50	1	072350344
45	10,5	65,50	1	072350345
46	11	65,50	1	072350346
47	12	65,50	1	072350347
48	13	65,50	1	072350348



CE

S3 SRC

EN ISO 20345 2011



7236BK

Action Nubuck ankle shoe, waterproof, with quick opening system and reinforcement polyurethane toe cap cover

- Steel toe cap
- Composite fibre penetration-proof insole

EU	UK	€		
35	2,5	68,50	1	072360335
36	3,5	68,50	1	072360336
37	4,5	68,50	1	072360337
38	5	68,50	1	072360338
39	6	68,50	1	072360339
40	6,5	68,50	1	072360340
41	7	68,50	1	072360341
42	8	68,50	1	072360342
43	9	68,50	1	072360343
44	10	68,50	1	072360344
45	10,5	68,50	1	072360345
46	11	68,50	1	072360346
47	12	68,50	1	072360347
48	13	68,50	1	072360348



CE

S3 RS SRC

EN ISO 20345 2011



7238WR

suede ankle shoe with nylon inserts, durable rubber outsole and quick opening system WR (water-resistant) footwear: after 1,000 steps in a tank with 3 cm of water, the wet internal surface has to be $\leq 3 \text{ cm}^2$ (spot)

- Composite toe cap
- Composite fibre penetration-proof insole

EU	UK	€		
35	2,5	92,00	1	072380235
36	3,5	92,00	1	072380236
37	4,5	92,00	1	072380237
38	5	92,00	1	072380238
39	6	92,00	1	072380239
40	6,5	92,00	1	072380240
41	7	92,00	1	072380241
42	8	92,00	1	072380242
43	9	92,00	1	072380243
44	10	92,00	1	072380244
45	10,5	92,00	1	072380245
46	11	92,00	1	072380246
47	12	92,00	1	072380247
48	13	92,00	1	072380248



CE

Endurance

S3 RS WR HRO SRC

EN ISO 20345 2011



7239B

nubuck ankle boot, water-repellent, with mesh inserts and reinforcement polyurethane toe cap cover

- Steel toe cap
- Composite fibre penetration proof insole

EU	UK	€		
39	6	99,00	1	072390339
40	6,5	99,00	1	072390340
41	7	99,00	1	072390341
42	8	99,00	1	072390342
43	9	99,00	1	072390343
44	10	99,00	1	072390344
45	10,5	99,00	1	072390345
46	11	99,00	1	072390346
47	12	99,00	1	072390347
48	13	99,00	1	072390348

CE



S3 SRC

EN ISO 20345 2011



7248GK

suede shoe with nylon inserts and reinforcement polyurethane toe cap cover

- Steel toe cap
- Composite fibre penetration-proof insole

EU	UK	€		
35	2,5	54,00	1	072480235
36	3,5	54,00	1	072480236
37	4,5	54,00	1	072480237
38	5	54,00	1	072480238
39	6	54,00	1	072480239
40	6,5	54,00	1	072480240
41	7	54,00	1	072480241
42	8	54,00	1	072480242
43	9	54,00	1	072480243
44	10	54,00	1	072480244
45	10,5	54,00	1	072480245
46	11	54,00	1	072480246
47	12	54,00	1	072480247
48	13	54,00	1	072480248

CE



S1P SRC

EN ISO 20345 2011



7249GK

suede ankle shoe with nylon inserts, quick opening system and reinforcement polyurethane toe cap cover

- Steel toe cap
- Composite fibre penetration-proof insole

EU	UK	€		
35	2,5	57,50	1	072490235
36	3,5	57,50	1	072490236
37	4,5	57,50	1	072490237
38	5	57,50	1	072490238
39	6	57,50	1	072490239
40	6,5	57,50	1	072490240
41	7	57,50	1	072490241
42	8	57,50	1	072490242
43	9	57,50	1	072490243
44	10	57,50	1	072490244
45	10,5	57,50	1	072490245
46	11	57,50	1	072490246
47	12	57,50	1	072490247
48	13	57,50	1	072490248

CE



S1P RS SRC

EN ISO 20345 2011

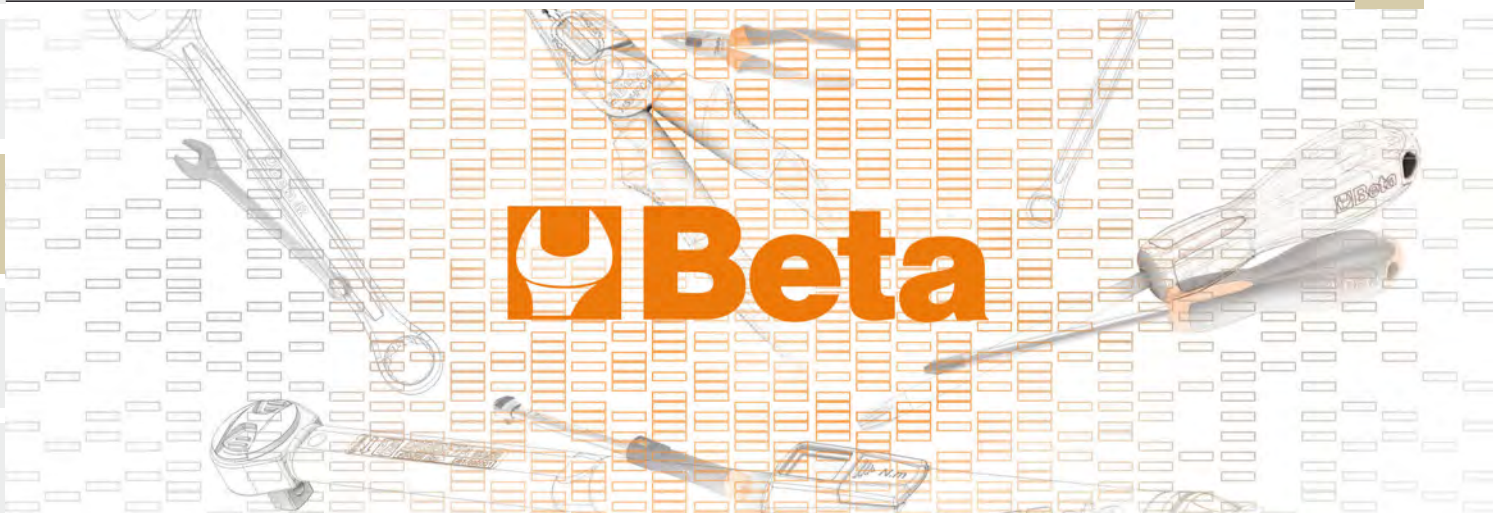

SNEAKERS



7314AF

suede shoe
with nylon mesh and carbon inserts

- Composite toe cap
- Composite fibre penetration proof insole

EU	UK	€	👤	📦
35	2,5	91,50	1	073140235
36	3,5	91,50	1	073140236
37	4,5	91,50	1	073140237
38	5	91,50	1	073140238
39	6	91,50	1	073140239
40	6,5	91,50	1	073140240
41	7	91,50	1	073140241
42	8	91,50	1	073140242
43	9	91,50	1	073140243
44	10	91,50	1	073140244
45	10,5	91,50	1	073140245
46	11	91,50	1	073140246
47	12	91,50	1	073140247
48	13	91,50	1	073140248



CE

S1P SRC

EN ISO
20345
2011



7315AN

suede and microfibre shoe,
water-repellent, with carbon inserts

- Composite toe cap
- Composite fibre penetration proof insole

EU	UK	€	👤	📦
35	2,5	105,50	1	073150535
36	3,5	105,50	1	073150536
37	4,5	105,50	1	073150537
38	5	105,50	1	073150538
39	6	105,50	1	073150539
40	6,5	105,50	1	073150540
41	7	105,50	1	073150541
42	8	105,50	1	073150542
43	9	105,50	1	073150543
44	10	105,50	1	073150544
45	10,5	105,50	1	073150545
46	11	105,50	1	073150546
47	12	105,50	1	073150547
48	13	105,50	1	073150548



CE

S3 SRC

EN ISO
20345
2011



7318AN

suede and microfibre ankle shoe,
water-repellent, with carbon inserts

- Composite toe cap
- Composite fibre penetration proof insole

EU	UK	€	👤	📦
35	2,5	109,00	1	073180535
36	3,5	109,00	1	073180536
37	4,5	109,00	1	073180537
38	5	109,00	1	073180538
39	6	109,00	1	073180539
40	6,5	109,00	1	073180540
41	7	109,00	1	073180541
42	8	109,00	1	073180542
43	9	109,00	1	073180543
44	10	109,00	1	073180544
45	10,5	109,00	1	073180545
46	11	109,00	1	073180546
47	12	109,00	1	073180547
48	13	109,00	1	073180548



CE

S3 SRC

EN ISO
20345
2011



7317NA

suede shoe, perforated,
with microfibre reinforcement in heel area

- Composite toe cap
- Composite fibre penetration proof insole

EU	UK	€	W	L
35	2,5	68,00	1	073170135
36	3,5	68,00	1	073170136
37	4,5	68,00	1	073170137
38	5	68,00	1	073170138
39	6	68,00	1	073170139
40	6,5	68,00	1	073170140
41	7	68,00	1	073170141
42	8	68,00	1	073170142
43	9	68,00	1	073170143
44	10	68,00	1	073170144
45	10,5	68,00	1	073170145
46	11	68,00	1	073170146
47	12	68,00	1	073170147
48	13	68,00	1	073170148

CE



S1P SRC



7320NA

nubuck shoe, water-repellent,
with antiabrasion reinforcement in toe cap area

- Composite toe cap
- Composite fibre penetration proof insole

EU	UK	€	W	L
35	2,5	71,50	1	073200435
36	3,5	71,50	1	073200436
37	4,5	71,50	1	073200437
38	5	71,50	1	073200438
39	6	71,50	1	073200439
40	6,5	71,50	1	073200440
41	7	71,50	1	073200441
42	8	71,50	1	073200442
43	9	71,50	1	073200443
44	10	71,50	1	073200444
45	10,5	71,50	1	073200445
46	11	71,50	1	073200446
47	12	71,50	1	073200447
48	13	71,50	1	073200448

CE



S3 SRC



7321NA

nubuck shoe, water-repellent,
with quick opening system and antiabrasion reinforcement in
toe cap area

- Composite toe cap
- Composite fibre penetration proof insole

EU	UK	€	W	L
35	2,5	74,00	1	073210435
36	3,5	74,00	1	073210436
37	4,5	74,00	1	073210437
38	5	74,00	1	073210438
39	6	74,00	1	073210439
40	6,5	74,00	1	073210440
41	7	74,00	1	073210441
42	8	74,00	1	073210442
43	9	74,00	1	073210443
44	10	74,00	1	073210444
45	10,5	74,00	1	073210445
46	11	74,00	1	073210446
47	12	74,00	1	073210447
48	13	74,00	1	073210448

CE



S3 RS SRC



7322SA

fabric shoe, highly resistant to abrasion,
with heel stability support

- Composite toe cap
- Composite fibre penetration proof insole

EU	UK	€	W	L
35	2,5	77,00	1	073220435
36	3,5	77,00	1	073220436
37	4,5	77,00	1	073220437
38	5	77,00	1	073220438
39	6	77,00	1	073220439
40	6,5	77,00	1	073220440
41	7	77,00	1	073220441
42	8	77,00	1	073220442
43	9	77,00	1	073220443
44	10	77,00	1	073220444
45	10,5	77,00	1	073220445
46	11	77,00	1	073220446
47	12	77,00	1	073220447
48	13	77,00	1	073220448

CE



S3 SRC



7323SA

fabric ankle shoe, highly resistant to abrasion, with quick opening system and heel stability support

- Composite toe cap
- Composite fibre penetration proof insole

EU	UK	€		
35	2,5	79,50	1	073230435
36	3,5	79,50	1	073230436
37	4,5	79,50	1	073230437
38	5	79,50	1	073230438
39	6	79,50	1	073230439
40	6,5	79,50	1	073230440
41	7	79,50	1	073230441
42	8	79,50	1	073230442
43	9	79,50	1	073230443
44	10	79,50	1	073230444
45	10,5	79,50	1	073230445
46	11	79,50	1	073230446
47	12	79,50	1	073230447
48	13	79,50	1	073230448

CE



NewActive



S3 RS SRC

EN ISO 20345 2011



O-GRAVITY



7352A

mesh fabric shoe, highly breathable, with TPU inserts
Heel stability support, stretch slip-on collar and EVA outsole with durable nitrile rubber tread

- Composite toe cap
- Composite fibre penetration-proof insole
- REMARKABLY LIGHTWEIGHT: approximate weight, size 42: 450 g

EU	UK	€		
38	5	116,00	1	073520038
39	6	116,00	1	073520039
40	6,5	116,00	1	073520040
41	7	116,00	1	073520041
42	8	116,00	1	073520042
43	9	116,00	1	073520043
44	10	116,00	1	073520044
45	10,5	116,00	1	073520045
46	11	116,00	1	073520046
47	12	116,00	1	073520047
48	13	116,00	1	073520048

CE



S1P HRO SRC

EN ISO 20345 2011



7352B

mesh fabric shoe, highly breathable, with TPU inserts
Heel stability support, stretch slip-on collar and EVA outsole with durable nitrile rubber tread

- Composite toe cap
- Composite fibre penetration-proof insole
- REMARKABLY LIGHTWEIGHT: approximate weight, size 42: 450 g

EU	UK	€		
38	5	116,00	1	073520138
39	6	116,00	1	073520139
40	6,5	116,00	1	073520140
41	7	116,00	1	073520141
42	8	116,00	1	073520142
43	9	116,00	1	073520143
44	10	116,00	1	073520144
45	10,5	116,00	1	073520145
46	11	116,00	1	073520146
47	12	116,00	1	073520147
48	13	116,00	1	073520148

CE



S1P HRO SRC

EN ISO 20345 2011



7352G

mesh fabric shoe, highly breathable, with TPU inserts
Heel stability support, traditional lacing, wide fit.
EVA outsole with durable nitrile rubber tread

- Composite toe cap
- Composite fibre penetration proof insole
- REMARKABLY LIGHTWEIGHT: approximate weight for size 42: 450 grams

EU	UK	€		
38	5	120,50	1	073520338
39	6	120,50	1	073520339
40	6,5	120,50	1	073520340
41	7	120,50	1	073520341
42	8	120,50	1	073520342
43	9	120,50	1	073520343
44	10	120,50	1	073520344
45	10,5	120,50	1	073520345
46	11	120,50	1	073520346
47	12	120,50	1	073520347
48	13	120,50	1	073520348

CE



EN ISO 20345 2011



S1P HRO SRC ESD

7352LG

women's mesh fabric shoe, highly breathable, with TPU inserts
High-visibility reflective mesh upper
Heel stability support, stretch slip-on collar and EVA outsole with durable nitrile rubber tread

- Fibreglass toe cap
- Composite fibre penetration proof insole
- REMARKABLY LIGHTWEIGHT: approximate weight for size 38: 390 grams

EU	UK	€		
34	2	120,00	1	073520234
35	2,5	120,00	1	073520235
36	3,5	120,00	1	073520236
37	4,5	120,00	1	073520237
38	5	120,00	1	073520238
39	6	120,00	1	073520239
40	6,5	120,00	1	073520240
41	7	120,00	1	073520241
42	8	120,00	1	073520242

CE



lady



EN ISO 20345 2011



S1P HRO SRC

7353Y

mesh fabric shoe, highly breathable, with TPU inserts
High-visibility reflective mesh upper
Heel stability support, stretch slip-on collar and EVA outsole with durable nitrile rubber tread

- Carbon fibre toe cap
- Composite fibre penetration-proof insole
- REMARKABLY LIGHTWEIGHT: approximate weight, size 42: 420 g

EU	UK	€		
38	5	149,50	1	073530038
39	6	149,50	1	073530039
40	6,5	149,50	1	073530040
41	7	149,50	1	073530041
42	8	149,50	1	073530042
43	9	149,50	1	073530043
44	10	149,50	1	073530044
45	10,5	149,50	1	073530045
46	11	149,50	1	073530046
47	12	149,50	1	073530047
48	13	149,50	1	073530048

CE



S1P HRO SRC

EN ISO 20345 2011



7354N

mesh fabric shoe, waterproof, with TPU inserts
Heel stability support, stretch slip-on collar and EVA outsole with durable nitrile rubber tread

- Composite toe cap
- Composite fibre penetration-proof insole
- REMARKABLY LIGHTWEIGHT: approximate weight for size 42: 460 g

EU	UK	€		
38	5	120,00	1	073540038
39	6	120,00	1	073540039
40	6,5	120,00	1	073540040
41	7	120,00	1	073540041
42	8	120,00	1	073540042
43	9	120,00	1	073540043
44	10	120,00	1	073540044
45	10,5	120,00	1	073540045
46	11	120,00	1	073540046
47	12	120,00	1	073540047
48	13	120,00	1	073540048

CE



EN ISO 20345 2011



S3 HRO SRC

7355V

mesh fabric ankle shoe, waterproof, with TPU inserts
Heel stability support, stretch slip-on collar and EVA outsole with durable nitrile rubber tread

• Composite toe cap • Composite fibre penetration-proof insole •
REMARKABLY LIGHTWEIGHT: approximate weight for size 42: 465 g

EU	UK	€		
38	5	128,00	1	073550038
39	6	128,00	1	073550039
40	6,5	128,00	1	073550040
41	7	128,00	1	073550041
42	8	128,00	1	073550042
43	9	128,00	1	073550043
44	10	128,00	1	073550044
45	10,5	128,00	1	073550045
46	11	128,00	1	073550046
47	12	128,00	1	073550047
48	13	128,00	1	073550048

CE



S3 HRO SRC



EN ISO 20345 2011



7356G

microfibre shoe, water-repellent, with TPU inserts
Heel stability support, stretch slip-on collar and EVA sole with durable nitrile rubber tread

• Composite toe cap
• Composite fibre penetration proof insole
• REMARKABLY LIGHTWEIGHT: approximate weight for size 42: 460 grams

EU	UK	€		
38	5	124,00	1	073560038
39	6	124,00	1	073560039
40	6,5	124,00	1	073560040
41	7	124,00	1	073560041
42	8	124,00	1	073560042
43	9	124,00	1	073560043
44	10	124,00	1	073560044
45	10,5	124,00	1	073560045
46	11	124,00	1	073560046
47	12	124,00	1	073560047
48	13	124,00	1	073560048

CE



S3 HRO SRC



EN ISO 20345 2011



7356V

microfibre shoe, water-repellent, with TPU inserts
Heel stability support, stretch slip-on collar and EVA outsole with durable nitrile rubber tread

• Composite toe cap
• Composite fibre penetration proof insole
• REMARKABLY LIGHTWEIGHT: approximate weight for size 42: 460 grams

EU	UK	€		
38	5	124,00	1	073560138
39	6	124,00	1	073560139
40	6,5	124,00	1	073560140
41	7	124,00	1	073560141
42	8	124,00	1	073560142
43	9	124,00	1	073560143
44	10	124,00	1	073560144
45	10,5	124,00	1	073560145
46	11	124,00	1	073560146
47	12	124,00	1	073560147
48	13	124,00	1	073560148

CE



S3 HRO SRC



EN ISO 20345 2011



7356LN

women's microfibre shoe, water-repellent, with TPU inserts
Heel stability support, stretch slip-on collar and EVA outsole with durable nitrile rubber tread

• Fibreglass toe cap
• Composite fibre penetration proof insole
• REMARKABLY LIGHTWEIGHT: approximate weight for size 38: 400 grams

EU	UK	€		
34	2	123,00	1	073560234
35	2,5	123,00	1	073560235
36	3,5	123,00	1	073560236
37	4,5	123,00	1	073560237
38	5	123,00	1	073560238
39	6	123,00	1	073560239
40	6,5	123,00	1	073560240
41	7	123,00	1	073560241
42	8	123,00	1	073560242

CE



S3 HRO SRC



EN ISO 20345 2011



7357G

microfibre ankle shoe, water-repellent, with TPU inserts
 Heel stability support, stretch slip-on collar and EVA sole with durable nitrile rubber tread

- Composite toe cap
- Composite fibre penetration proof insole
- REMARKABLY LIGHTWEIGHT: approximate weight for size 42: 480 grams

EU	UK	€	⚙️	📦
38	5	137,00	1	073570038
39	6	137,00	1	073570039
40	6,5	137,00	1	073570040
41	7	137,00	1	073570041
42	8	137,00	1	073570042
43	9	137,00	1	073570043
44	10	137,00	1	073570044
45	10,5	137,00	1	073570045
46	11	137,00	1	073570046
47	12	137,00	1	073570047
48	13	137,00	1	073570048



CE

S3 HRO SRC



7357V

microfibre ankle shoe, water-repellent, with TPU inserts
 Heel stability support, stretch-slip on collar and EVA outsole with durable nitrile rubber tread

- Composite toe cap
- Composite fibre penetration proof insole
- REMARKABLY LIGHTWEIGHT: approximate weight for size 42: 480 grams

EU	UK	€	⚙️	📦
38	5	137,00	1	073570138
39	6	137,00	1	073570139
40	6,5	137,00	1	073570140
41	7	137,00	1	073570141
42	8	137,00	1	073570142
43	9	137,00	1	073570143
44	10	137,00	1	073570144
45	10,5	137,00	1	073570145
46	11	137,00	1	073570146
47	12	137,00	1	073570147
48	13	137,00	1	073570148



CE

S3 HRO SRC



7362B

occupational shoe, made of mesh fabric, highly breathable, with TPU inserts
 Heel stability support, stretch slip-on collar and EVA sole with durable nitrile rubber tread

- Without toe cap
- Without penetration-proof insole
- REMARKABLY LIGHTWEIGHT: approximate weight for size 42: 330 grams

EU	UK	€	⚙️	📦
39	6	105,50	1	073620039
40	6,5	105,50	1	073620040
41	7	105,50	1	073620041
42	8	105,50	1	073620042
43	9	105,50	1	073620043
44	10	105,50	1	073620044
45	10,5	105,50	1	073620045
46	11	105,50	1	073620046
47	12	105,50	1	073620047
48	13	105,50	1	073620048



CE

O1 FO HRO SRC



7363N

occupational shoe, made of mesh fabric, water-repellent, with TPU inserts
 Heel stability support, stretch slip-on collar and EVA sole with durable nitrile rubber tread

- Without toe cap
- Without penetration-proof insole
- REMARKABLY LIGHTWEIGHT: approximate weight for size 42: 330 grams

EU	UK	€	⚙️	📦
39	6	110,00	1	073630039
40	6,5	110,00	1	073630040
41	7	110,00	1	073630041
42	8	110,00	1	073630042
43	9	110,00	1	073630043
44	10	110,00	1	073630044
45	10,5	110,00	1	073630045
46	11	110,00	1	073630046
47	12	110,00	1	073630047
48	13	110,00	1	073630048



CE

O2 FO HRO SRC



SNEAKERS PRO



7340B

mesh fabric shoe, highly breathable,
with high-frequency PU inserts and protective toe cap
reinforcement made of crust suede.
Extremely lightweight - approximate weight, size 42: 470 g

- Aluminium toe cap
- Composite fibre penetration-proof insole
- FixLock closing makes it easier to put and remove the shoe (traditional laces included)

EN ISO
20345
2011



EU	UK	€	W	Icon	Product Code
36	3,5	147,50	1		073400236
37	4,5	147,50	1		073400237
38	5	147,50	1		073400238
39	6	147,50	1		073400239
40	6,5	147,50	1		073400240
41	7	147,50	1		073400241
42	8	147,50	1		073400242
43	9	147,50	1		073400243
44	10	147,50	1		073400244
45	10,5	147,50	1		073400245
46	11	147,50	1		073400246
47	12	147,50	1		073400247



FIT PRO NET

CE

S1P SRC

7340R

mesh fabric shoe, highly breathable,
with high-frequency PU inserts and protective toe cap
reinforcement made of crust suede.
Extremely lightweight - approximate weight, size 42: 470 g

- Aluminium toe cap
- Composite fibre penetration-proof insole
- FixLock closing makes it easier to put and remove the shoe (traditional laces included)

EN ISO
20345
2011



EU	UK	€	W	Icon	Product Code
36	3,5	147,50	1		073400436
37	4,5	147,50	1		073400437
38	5	147,50	1		073400438
39	6	147,50	1		073400439
40	6,5	147,50	1		073400440
41	7	147,50	1		073400441
42	8	147,50	1		073400442
43	9	147,50	1		073400443
44	10	147,50	1		073400444
45	10,5	147,50	1		073400445
46	11	147,50	1		073400446
47	12	147,50	1		073400447



FIT PRO NET

CE

S1P SRC

7341N

microsuede shoe, waterproof,
with high-frequency PU inserts and protective toe cap
reinforcement made of crust suede.
Extremely lightweight - approximate weight, size 42: 470 g

- Aluminium toe cap
- Composite fibre penetration-proof insole
- FixLock closing makes it easier to put and remove the shoe (traditional laces included)

EN ISO
20345
2011



EU	UK	€	W	Icon	Product Code
36	3,5	155,00	1		073410236
37	4,5	155,00	1		073410237
38	5	155,00	1		073410238
39	6	155,00	1		073410239
40	6,5	155,00	1		073410240
41	7	155,00	1		073410241
42	8	155,00	1		073410242
43	9	155,00	1		073410243
44	10	155,00	1		073410244
45	10,5	155,00	1		073410245
46	11	155,00	1		073410246
47	12	155,00	1		073410247



FIT PRO

CE

S3 SRC

7349RP

shoe made of Nubuck crust leather, waterproof with rubber outsole and soft PU ring

- Composite toe cap
- Composite fibre penetration proof insole

EU	UK	€		
38	5	156,50	1	073490138
39	6	156,50	1	073490139
40	6,5	156,50	1	073490140
41	7	156,50	1	073490141
42	8	156,50	1	073490142
43	9	156,50	1	073490143
44	10	156,50	1	073490144
45	10,5	156,50	1	073490145
46	11	156,50	1	073490146
47	12	156,50	1	073490147



CE

S3 HRO SRC

EN ISO 20345 2011



7350RP

ankle shoe made of Nubuck crust leather, waterproof with rubber outsole and soft PU ring

- Composite toe cap
- Composite fibre penetration proof insole

EU	UK	€		
38	5	160,00	1	073500138
39	6	160,00	1	073500139
40	6,5	160,00	1	073500140
41	7	160,00	1	073500141
42	8	160,00	1	073500142
43	9	160,00	1	073500143
44	10	160,00	1	073500144
45	10,5	160,00	1	073500145
46	11	160,00	1	073500146
47	12	160,00	1	073500147



CE

S3 HRO SRC

EN ISO 20345 2011



HEAVY DUTY



7293HM

greased full-grain leather shoe, water-repellent, with high-performance VIBRAM® rubber tread, anti-abrasion insert on heel area and reinforcement polyurethane toe cap cover

- Fibreglass toe cap
- Composite fibre penetration proof insole

EU	UK	€		
39	6	163,50	1	072930639
40	6,5	163,50	1	072930640
41	7	163,50	1	072930641
42	8	163,50	1	072930642
43	9	163,50	1	072930643
44	10	163,50	1	072930644
45	10,5	163,50	1	072930645
46	11	163,50	1	072930646
47	12	163,50	1	072930647
48	13	163,50	1	072930648



CE

S3 HRO HI SRC

EN ISO 20345 2011



7293HN

Nubuck shoe, waterproof,
with SUPPORT SYSTEM for lateral ankle support
Durable rubber tread and PU toe cap
Wide body

- Steel toe cap
- Composite fibre penetration-proof insole

E	U	€		
39	6	129,00	1	072930839
40	6,5	129,00	1	072930840
41	7	129,00	1	072930841
42	8	129,00	1	072930842
43	9	129,00	1	072930843
44	10	129,00	1	072930844
45	10,5	129,00	1	072930845
46	11	129,00	1	072930846
47	12	129,00	1	072930847

CE



S3 HRO HI SRC



EN ISO
20345
2011



7294HM

greased full-grain leather ankle shoe, water-repellent,
with high-performance VIBRAM® rubber tread, anti-abrasion insert
on heel area
and reinforcement polyurethane toe cap cover

- Fibreglass toe cap
- Composite fibre penetration proof insole

EU	UK	€		
39	6	173,00	1	072940639
40	6,5	173,00	1	072940640
41	7	173,00	1	072940641
42	8	173,00	1	072940642
43	9	173,00	1	072940643
44	10	173,00	1	072940644
45	10,5	173,00	1	072940645
46	11	173,00	1	072940646
47	12	173,00	1	072940647
48	13	173,00	1	072940648

CE



S3 HRO HI SRC



EN ISO
20345
2011



7294HMC

greased full-grain leather ankle shoe, water-repellent,
with high-performance VIBRAM® rubber tread, anti-abrasion insert
on heel area and reinforcement polyurethane toe cap cover.
With Tepor membrane, waterproof, windproof, highly breathable

- Fibreglass toe cap
- Composite fibre penetration proof insole

EU	UK	€		
39	6	192,50	1	072940739
40	6,5	192,50	1	072940740
41	7	192,50	1	072940741
42	8	192,50	1	072940742
43	9	192,50	1	072940743
44	10	192,50	1	072940744
45	10,5	192,50	1	072940745
46	11	192,50	1	072940746
47	12	192,50	1	072940747
48	13	192,50	1	072940748

CE



S3 HRO HI CI WR SRC



EN ISO
20345
2011



7294HN

Nubuck ankle shoe, waterproof, with SUPPORT SYSTEM for
lateral ankle support and quick opening system
Durable rubber tread and PU toe cap
Wide body

- Steel toe cap
- Composite fibre penetration-proof insole

EU	UK	€		
39	6	133,00	1	072940839
40	6,5	133,00	1	072940840
41	7	133,00	1	072940841
42	8	133,00	1	072940842
43	9	133,00	1	072940843
44	10	133,00	1	072940844
45	10,5	133,00	1	072940845
46	11	133,00	1	072940846
47	12	133,00	1	072940847

CE



S3 HRO HI RS SRC



EN ISO
20345
2011



ACCESSORIES

7398 O/G

anatomically shaped underfoot covers made of EVA foam, with cushioning heel pad (spare part recommended for O-Gravity footwear range)



EU	UK	€	👤	📦
38	5	6,60	1	073981238
39	6	6,60	1	073981239
40	6,5	6,60	1	073981240
41	7	6,60	1	073981241
42	8	6,60	1	073981242
43	9	6,60	1	073981243
44	10	6,60	1	073981244
45	10,5	6,60	1	073981245
46	11	6,60	1	073981246
47	12	6,60	1	073981247
48	13	6,60	1	073981248

7398T

anatomically shaped underfoot covers WINTHERM insulation. 70% aluminized polyester, 30% polyethylene, bonded to non-woven synthetic fibres. Antistatic, breathable, rapidly absorbing, anti-odour, antibacterial, antifungicide.



EU	UK	€	👤	📦
35	2,5	13,20	1	073981335
36	3,5	13,20	1	073981336
37	4,5	13,20	1	073981337
38	5	13,20	1	073981338
39	6	13,20	1	073981339
40	6,5	13,20	1	073981340
41	7	13,20	1	073981341
42	8	13,20	1	073981342
43	9	13,20	1	073981343
44	10	13,20	1	073981344
45	10,5	13,20	1	073981345
46	11	13,20	1	073981346
47	12	13,20	1	073981347
48	13	13,20	1	073981348

7398U

anatomically shaped underfoot covers made of TPR GEL with high cushioning effect, plantar arch support and heel pad



EU	UK	€	👤	📦
36 - 40	3,5 - 6,5	12,20	1	073980058
41 - 46	7 - 11	12,20	1	073980063

7398UP

anatomically shaped underfoot covers made of citrus-fragrant TPE GEL, with plantar arch support



EU	UK	€	👤	📦
36 - 40	3,5 - 6	11,10	1	073980076
41 - 46	7 - 11	11,10	1	073980081

7398GEL

anatomically shaped underfoot covers with gel insets



EU	UK	€	👤	📦
35	2,5	4,05	1	073980835
36	3,5	4,05	1	073980836
37	4,5	4,05	1	073980837
38	5	4,05	1	073980838
39	6	4,05	1	073980839
40	6,5	4,05	1	073980840
41	7	4,05	1	073980841
42	8	4,05	1	073980842
43	9	4,05	1	073980843
44	10	4,05	1	073980844
45	10,5	4,05	1	073980845
46	11	4,05	1	073980846
47	12	4,05	1	073980847
48	13	4,05	1	073980848

7398EF

anatomically shaped underfoot covers made of polyurethane foam, with cushioning heel lift



EU	UK	€	👤	📦
35	2,5	7,70	1	073981135
36	3,5	7,70	1	073981136
37	4,5	7,70	1	073981137
38	5	7,70	1	073981138
39	6	7,70	1	073981139
40	6,5	7,70	1	073981140
41	7	7,70	1	073981141
42	8	7,70	1	073981142
43	9	7,70	1	073981143
44	10	7,70	1	073981144
45	10,5	7,70	1	073981145
46	11	7,70	1	073981146
47	12	7,70	1	073981147
48	13	7,70	1	073981148

7399 A/N...

pack of 10 pairs of laces



cm	€	👤	📦
100	14,60	1	073990010
120	17,10	1	073990012
140	20,90	1	073990017

Prices refer to 10 pairs

7421

knee-length socks made from elastic compression terry, with nylon and cotton reinforcements on toe and heel areas Soles made from hard-wearing, antimycotic, breathable bamboo fibre



	EU	€	👤	📦
M	39-42	15,40	1	074210002
L	43-46	15,40	1	074210004

7423

elastic compression ankle-length socks with nylon and cotton reinforcements on toe and heel areas Soles made from hard-wearing, antimycotic, breathable bamboo fibre



	EU	€	👤	📦
M	39-42	9,95	1	074230002
L	43-46	9,95	1	074230004

7425

ankle-length socks with breathable texture inserts and nylon/cotton reinforcements on toe and heel areas Soles made from nylon woven with hard-wearing, antimycotic, breathable bamboo fibre



	EU	€	👤	📦
M	39-42	10,20	1	074250002
L	43-46	10,20	1	074250004

7427

maxi sneaker socks with protective, breathable inserts on shinbone and instep areas. Nylon and cotton reinforcements on toe and heel areas and soles made from hard-wearing, antimycotic, breathable fibre



	EU	€	👤	📦
M	39-42	8,55	1	074270002
L	43-46	8,55	1	074270004

7429

maxi sneaker socks with breathable texture inserts and nylon/cotton reinforcements on toe and heel areas Soles made from nylon woven with hard-wearing, antimycotic, breathable bamboo fibre



	EU	€	👤	📦
M	39-42	7,95	1	074290002
L	43-46	7,95	1	074290004

7431P

two pairs of sneaker socks with breathable texture inserts and nylon/cotton reinforcements on toe and heel areas

Soles made from nylon woven with hard-wearing, antimycotic, breathable bamboo fibre. One pair in black/orange colour and one pair in black/grey colour.



	EU	€	👤	📦
M	39-42	7,60	1	074310102
L	43-46	7,60	1	074310104





WORKWEAR

Beta WORK

Over the years the workwear line has gained confidence and popularity among the most demanding professionals. The success of the product has translated into the ongoing development and expansion of the range.

The items of clothing produced by Beta Utensili S.p.a. comply with the following standard: **EN ISO 13688:2013**

Personal protective equipment protects the user from limited physical hazards, including small abrasions, sunbeams, wind, cold, non-harmful powders and dirt from nontoxic materials. Such protection is related to the first category of Italian Parliamentary Bill n°. 475 of 04/12/1992.

USE AND STORAGE INSTRUCTIONS

The garment should be worn correctly, so that it can protect the user's body parts. It should be stored in a cool, dry place, in its original packaging, away from heat sources, sunlight, dust and adverse weather.

PACKAGING

- WORKWEAR: hanging bag
- FREE TIME WEAR: non-hanging bag

SHRINKAGE

All natural fibres shrink after being washed. The degree of shrinkage may range from 1% to 5%, depending on several parameters, which include the type of fibres and the temperature of water.

	I	F	D	E	UK	USA
XS	46	38	42	40	30	32
S	48	40	44	42	32	34
M	50	42	46	44	34	36
L	52	44	48	46	36	38
XL	54	46	50	48	38	40
2XL	56	48	52	50	40	42
3XL	58	50	54	52	42	44
4XL	60	52	56	54	44	46

EN ISO 13688:2013								
	XS	S	M	L	XL	2XL	3XL	4XL
A	88-92	92-96	96-104	104-108	108-116	116-124	124-132	132-140
B	79-83	83-87	87-91	91-95	95-100	100-107	107-112	112-120
H	158-164	164-170	170-176	176-182	182-188	188-194	194-200	200-206

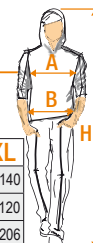

PANTS



7525

prewashed stretch work jeans, 68% denim cotton, 29% polyester, 3% stretch fabric, 10 ounces

CE



SIZE	€	QTY	SKU
XS	58,00	1	075250046
S	58,00	1	075250048
M	58,00	1	075250050
L	58,00	1	075250052
XL	58,00	1	075250054
XXL	58,00	1	075250056
XXXL	58,00	1	075250058

7528

stretch work jeans trousers, 98% cotton, 2% stretch fabric, slim fit

CE



SIZE	€	QTY	SKU
XS	54,50	1	075280046
S	54,50	1	075280048
M	54,50	1	075280050
L	54,50	1	075280052
XL	54,50	1	075280054
XXL	54,50	1	075280056
XXXL	54,50	1	075280058

7650

stretch work trousers, multipocket style 90% nylon - 10% spandex, 260 g/m², anthracite grey
Knee pad pockets, rear pockets and leg bottoms reinforced in polyester 600D, tearproof crotch

CE



SIZE	€	QTY	SKU
XS	84,50	1	076500000
S	84,50	1	076500001
M	84,50	1	076500002
L	84,50	1	076500003
XL	84,50	1	076500004
XXL	84,50	1	076500005
XXXL	84,50	1	076500006

7650B

stretch work trousers, multipocket style, 90% nylon - 10% spandex, 260 g/m², blue
Knee pad pockets, rear pockets and leg bottoms reinforced in polyester 600D, tearproof crotch

CE



SIZE	€	QTY	SKU
XS	84,50	1	076500100
S	84,50	1	076500101
M	84,50	1	076500102
L	84,50	1	076500103
XL	84,50	1	076500104
XXL	84,50	1	076500105
XXXL	84,50	1	076500106

7660B

stretch work trousers, lightweight, multipocket style, 86% nylon - 14% spandex, 140 g/m², blue
Knee pad pockets, rear pockets reinforced in polyester 300D, tearproof crotch
Slim fit

CE



SIZE	€	QTY	SKU
XS	72,50	1	076600100
S	72,50	1	076600101
M	72,50	1	076600102
L	72,50	1	076600103
XL	72,50	1	076600104
XXL	72,50	1	076600105
XXXL	72,50	1	076600106

7660G

stretch work trousers, lightweight, multipocket style, 86% nylon - 14% spandex, 140 g/m², anthracite grey
Knee pad pockets, rear pockets reinforced in polyester 300D, tearproof crotch
Slim fit

CE



	€		
XS	72,50	1	076600000
S	72,50	1	076600001
M	72,50	1	076600002
L	72,50	1	076600003
XL	72,50	1	076600004
XXL	72,50	1	076600005
XXXL	72,50	1	076600006

4-WAY STRETCH

Fabrics marked with the 4-Way Stretch symbol stretch and regain their shapes both widthwise and lengthwise.

Based on this behaviour, they are extremely elastic and comfortable, to ensure the best fit and unparalleled comfort, thereby resulting in total freedom of movement in every situation.

Hence they mean the ideal choice for those who expect ultimate performance from workwear.



7810

"work trekking" trousers, multipocket style, HEAVY 90% nylon, 10% stretch fabric, 265 g/m², anthracite grey
Slim cut, ergonomic fit for ease of movement, bi-stretchable fabric for improved comfort.
Reinforced inserts on knees, crotch and leg bottom



	€		
S	77,00	1	078100101
M	77,00	1	078100102
L	77,00	1	078100103
XL	77,00	1	078100104
XXL	77,00	1	078100105

7812

"work trekking" trousers, LIGHT, 95% nylon, 5% stretch fabric, 140 g/m², grey
Slim cut, ergonomic fit for ease of movement, bi-stretchable fabric for improved comfort, reinforced inserts on knees, crotch and leg bottom



	€		
S	70,50	1	078120001
M	70,50	1	078120002
L	70,50	1	078120003
XL	70,50	1	078120004
XXL	70,50	1	078120005

7816BL

work trousers, multipocket style, T/C canvas, 260 g/m², blue
Knee pad pockets and leg bottoms reinforced in polyester 600D, tearproof crotch and stretch rear insert for easier movements

CE



	€		
XS	70,50	1	078160100
S	70,50	1	078160101
M	70,50	1	078160102
L	70,50	1	078160103
XL	70,50	1	078160104
XXL	70,50	1	078160105
XXXL	70,50	1	078160106

7816G

work trousers, multipocket style, in T/C canvas 260 g/m², grey
Knee pad pockets and leg bottoms reinforced in polyester 600D, tearproof crotch and elastic rear insert for easier movements

CE



	€		
XS	70,50	1	078160000
S	70,50	1	078160001
M	70,50	1	078160002
L	70,50	1	078160003
XL	70,50	1	078160004
XXL	70,50	1	078160005
XXXL	70,50	1	078160006

7817N

"work trekking" trousers, multipocket style, HEAVY, 90% nylon, 10% stretch fabric, 265 g/m², black Slim cut, ergonomic fit for ease of movement and bi-stretch fabric for improved comfort. Reinforced inserts on knees, crotch and leg bottom



SIZE	€	STRETCH	SKU
S	77,00	1	078170101
M	77,00	1	078170102
L	77,00	1	078170103
XL	77,00	1	078170104
XXL	77,00	1	078170105

7819B

"work trekking" trousers, LIGHT, 95% nylon, 5% stretch fabric, 140 g/m², blue Slim cut, ergonomic fit for ease of movement and bi-stretch fabric for improved comfort. Reinforced inserts on knees, crotch and leg bottom



SIZE	€	STRETCH	SKU
S	70,50	1	078190101
M	70,50	1	078190102
L	70,50	1	078190103
XL	70,50	1	078190104
XXL	70,50	1	078190105

7830ST

stretch work trousers, T/C twill, 250 g/m², grey Slim fit, tearproof crotch and stretch waistband on sides

CE



SIZE	€	STRETCH	SKU
XS	57,50	1	078300000
S	57,50	1	078300001
M	57,50	1	078300002
L	57,50	1	078300003
XL	57,50	1	078300004
XXL	57,50	1	078300005
XXXL	57,50	1	078300006

7840BL

work trousers, T/C twill, 245 g/m², blue Stretch waistband on sides

CE



SIZE	€	STRETCH	SKU
XS	37,00	1	078400100
S	37,00	1	078400101
M	37,00	1	078400102
L	37,00	1	078400103
XL	37,00	1	078400104
XXL	37,00	1	078400105
XXXL	37,00	1	078400106
XXXXL	37,00	1	078400107

7860G

work trousers, lightweight, in T/C twill, 180 g/m², with Oxford inserts, grey New design - Improved fit

CE



SIZE	€	STRETCH	SKU
XS	47,50	1	078600800
S	47,50	1	078600801
M	47,50	1	078600802
L	47,50	1	078600803
XL	47,50	1	078600804
XXL	47,50	1	078600805
XXXL	47,50	1	078600806
XXXXL	47,50	1	078600807

7880SC

stretch work trousers, T/C canvas, 290 g/m², black Slim fit, tearproof crotch and stretch waistband on sides

CE



SIZE	€	STRETCH	SKU
XS	58,50	1	078800000
S	58,50	1	078800001
M	58,50	1	078800002
L	58,50	1	078800003
XL	58,50	1	078800004
XXL	58,50	1	078800005
XXXL	58,50	1	078800006

7900B

work trousers,
in T/C canvas, 260 g/m², with Oxford inserts,
blue

CE

BetaEASY



	€		
XS	52,50	1	079000700
S	52,50	1	079000701
M	52,50	1	079000702
L	52,50	1	079000703
XL	52,50	1	079000704
XXL	52,50	1	079000705
XXXL	52,50	1	079000706
XXXXL	52,50	1	079000707

7900G

work trousers,
in T/C canvas, 260 g/m², with Oxford inserts,
grey
New design - Improved fit

CE

BetaEASY



	€		
XS	52,50	1	079000800
S	52,50	1	079000801
M	52,50	1	079000802
L	52,50	1	079000803
XL	52,50	1	079000804
XXL	52,50	1	079000805
XXXL	52,50	1	079000806
XXXXL	52,50	1	079000807

7900P

work trousers,
in T/C canvas, 260 g/m², with Oxford inserts,
petrol blue

CE

BetaEASY



	€		
XS	52,50	1	079000600
S	52,50	1	079000601
M	52,50	1	079000602
L	52,50	1	079000603
XL	52,50	1	079000604
XXL	52,50	1	079000605
XXXL	52,50	1	079000606
XXXXL	52,50	1	079000607

7900V

work trousers,
in T/C canvas, 260 g/m², with Oxford inserts,
green

CE

BetaEASY



	€		
XS	52,50	1	079000500
S	52,50	1	079000501
M	52,50	1	079000502
L	52,50	1	079000503
XL	52,50	1	079000504
XXL	52,50	1	079000505
XXXL	52,50	1	079000506
XXXXL	52,50	1	079000507

7930G

work trousers,
97% cotton, 3% stretch fabric, 220 g/m²
Slim fit

CE

Cotton



	€		
XS	57,50	1	079300300
S	57,50	1	079300301
M	57,50	1	079300302
L	57,50	1	079300303
XL	57,50	1	079300304
XXL	57,50	1	079300305
XXXL	57,50	1	079300306

7940

multi-protection work trousers
T/C twill, 250 g/m², blue,
for protection from heat, flames, electric arc
effects, welding hazards and chemicals.

CE



7949



595

DPI: III* Categoria
EN ISO 11611:2015 - Classe 1
EN ISO 11612:2015 - A1 B1 C1
EN 1149-5:2018
EN13034:2005+A1:2009 - Type 6
IEC 61482-2:2018 - APC 1

	€		
XS	77,00	1	079400000
S	77,00	1	079400001
M	77,00	1	079400002
L	77,00	1	079400003
XL	77,00	1	079400004
XXL	77,00	1	079400005
XXXL	77,00	1	079400006
XXXXL	77,00	1	079400007

BERMUDA



7529

stretch work jeans bermuda shorts,
98% cotton, 2% stretch fabric,
slim fit

CE



SIZE	€	W	L
XS	43,50	1	075290046
S	43,50	1	075290048
M	43,50	1	075290050
L	43,50	1	075290052
XL	43,50	1	075290054
XXL	43,50	1	075290056
XXXL	43,50	1	075290058

7661B

stretch work Bermuda shorts,
lightweight, multipocket style,
86% nylon - 14% spandex, 140 g/m², blue
Rear pockets reinforced in
polyester 300D, tearproof crotch
Slim fit

CE



SIZE	€	W	L
XS	63,00	1	076610100
S	63,00	1	076610101
M	63,00	1	076610102
L	63,00	1	076610103
XL	63,00	1	076610104
XXL	63,00	1	076610105
XXXL	63,00	1	076610106

7661G

stretch work Bermuda shorts, lightweight,
multipocket style,
86% nylon - 14% spandex, 140 g/
m², anthracite grey
Rear pockets reinforced in
polyester 300D, tearproof crotch
Slim fit

CE



SIZE	€	W	L
XS	63,00	1	076610000
S	63,00	1	076610001
M	63,00	1	076610002
L	63,00	1	076610003
XL	63,00	1	076610004
XXL	63,00	1	076610005
XXXL	63,00	1	076610006

7813

"work trekking" Bermuda shorts, LIGHT,
95% nylon, 5% stretch fabric, 140 g/m², grey
Slim cut, ergonomic fit for ease of movement,
bi-stretchable fabric for improved comfort



SIZE	€	W	L
S	55,50	1	078130001
M	55,50	1	078130002
L	55,50	1	078130003
XL	55,50	1	078130004
XXL	55,50	1	078130005

7831ST

stretch work Bermuda shorts,
T/C twill, 250 g/m², grey
Slim fit, tearproof crotch and stretch waistband
on sides

CE



SIZE	€	W	L
XS	44,00	1	078310000
S	44,00	1	078310001
M	44,00	1	078310002
L	44,00	1	078310003
XL	44,00	1	078310004
XXL	44,00	1	078310005
XXXL	44,00	1	078310006

7861G

work Bermuda shorts, lightweight,
in T/C twill, 180 g/m², with Oxford inserts, grey
New design - Improved fit

CE



Beta EASY



SIZE	€	W	L
XS	40,00	1	078610800
S	40,00	1	078610801
M	40,00	1	078610802
L	40,00	1	078610803
XL	40,00	1	078610804
XXL	40,00	1	078610805
XXXL	40,00	1	078610806
XXXXL	40,00	1	078610807

7901G

work Bermuda shorts,
in T/C canvas, 260 g/m², with Oxford inserts,
grey
New design - Improved fit

CE

Beta EASY



SIZE	€	W	L
XS	43,00	1	079010800
S	43,00	1	079010801
M	43,00	1	079010802
L	43,00	1	079010803
XL	43,00	1	079010804
XXL	43,00	1	079010805
XXXL	43,00	1	079010806
XXXXL	43,00	1	079010807

7931G

work Bermuda shorts,
100% stretch cotton, 220 g/m²
Slim fit

CE



SIZE	€	W	L
XS	44,00	1	079310300
S	44,00	1	079310301
M	44,00	1	079310302
L	44,00	1	079310303
XL	44,00	1	079310304
XXL	44,00	1	079310305
XXXL	44,00	1	079310306

OVERALLS

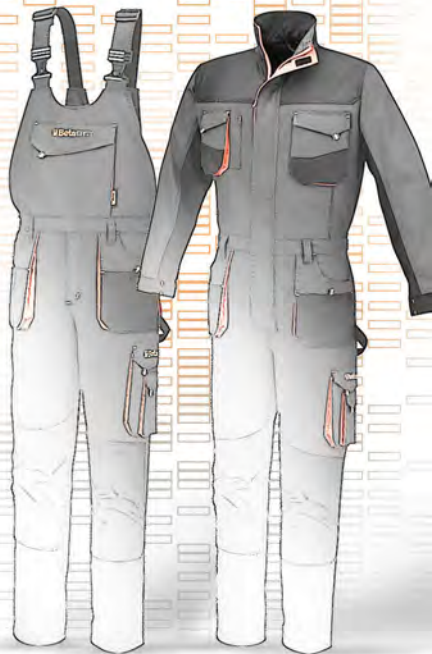

7863G

work bib and brace overalls, lightweight, in T/C twill, 180 g/m², with Oxford inserts, grey
New design - Improved fit

BetaEASY

CE

LIGHT



	€		
XS	58,50	1	078630800
S	58,50	1	078630801
M	58,50	1	078630802
L	58,50	1	078630803
XL	58,50	1	078630804
XXL	58,50	1	078630805
XXXL	58,50	1	078630806
XXXXL	58,50	1	078630807

7903G

work bib and brace overalls, in T/C canvas, 260 g/m², with Oxford inserts, grey
New design - Improved fit

CE

BetaEASY



	€		
XS	66,00	1	079030800
S	66,00	1	079030801
M	66,00	1	079030802
L	66,00	1	079030803
XL	66,00	1	079030804
XXL	66,00	1	079030805
XXXL	66,00	1	079030806
XXXXL	66,00	1	079030807

7903P

work bib and brace overalls, in T/C canvas, 260 g/m², with Oxford inserts, petrol blue

BetaEASY

CE



	€		
XS	66,00	1	079030600
S	66,00	1	079030601
M	66,00	1	079030602
L	66,00	1	079030603
XL	66,00	1	079030604
XXL	66,00	1	079030605
XXXL	66,00	1	079030606
XXXXL	66,00	1	079030607

7933G

work overalls, 100% stretch cotton, 220 g/m²
Slim fit

CE



	€		
XS	71,50	1	079330300
S	71,50	1	079330301
M	71,50	1	079330302
L	71,50	1	079330303
XL	71,50	1	079330304
XXL	71,50	1	079330305
XXXL	71,50	1	079330306

7865G

work overalls, lightweight, in T/C twill, 180 g/m², with Oxford inserts, grey
New design - Improved fit

CE

BetaEASY

LIGHT



	€		
XS	76,00	1	078650800
S	76,00	1	078650801
M	76,00	1	078650802
L	76,00	1	078650803
XL	76,00	1	078650804
XXL	76,00	1	078650805
XXXL	76,00	1	078650806
XXXXL	76,00	1	078650807

7905G

work overalls
in T/C canvas, 260 g/m², with Oxford inserts,
grey
New design - Improved fit

BetaEASY

CE



SIZE	€	ST	ART
XS	82,50	1	079050800
S	82,50	1	079050801
M	82,50	1	079050802
L	82,50	1	079050803
XL	82,50	1	079050804
XXL	82,50	1	079050805
XXXL	82,50	1	079050806
XXXXL	82,50	1	079050807

7935G

work overalls,
100% stretch cotton, 220 g/m²
Slim fit

CE Cotton



SIZE	€	ST	ART
XS	96,00	1	079350300
S	96,00	1	079350301
M	96,00	1	079350302
L	96,00	1	079350303
XL	96,00	1	079350304
XXL	96,00	1	079350305
XXXL	96,00	1	079350306

WORK JACKETS



7849BL

work jacket, T/C twill, 245 g/m², blue
Stretch waistband

CE

BetaEASY



SIZE	€	ST	ART
XS	40,00	1	078490100
S	40,00	1	078490101
M	40,00	1	078490102
L	40,00	1	078490103
XL	40,00	1	078490104
XXL	40,00	1	078490105
XXXL	40,00	1	078490106
XXXXL	40,00	1	078490107

7869G

work jacket, lightweight,
in T/C twill, 180 g/m², with Oxford inserts, grey
New design - Improved fit

CE

BetaEASY

LIGHT



SIZE	€	ST	ART
XS	52,00	1	078690800
S	52,00	1	078690801
M	52,00	1	078690802
L	52,00	1	078690803
XL	52,00	1	078690804
XXL	52,00	1	078690805
XXXL	52,00	1	078690806
XXXXL	52,00	1	078690807

7909B

work jacket,
in T/C canvas, 260 g/m², with Oxford inserts,
blue

CE

BetaEASY



SIZE	€	ST	ART
XS	58,50	1	079090700
S	58,50	1	079090701
M	58,50	1	079090702
L	58,50	1	079090703
XL	58,50	1	079090704
XXL	58,50	1	079090705
XXXL	58,50	1	079090706
XXXXL	58,50	1	079090707

7909G

work jacket,
in T/C canvas, 260 g/m², with Oxford inserts,
grey
New design - Improved fit

CE

BetaEASY



SIZE	€	ST	ART
XS	58,50	1	079090800
S	58,50	1	079090801
M	58,50	1	079090802
L	58,50	1	079090803
XL	58,50	1	079090804
XXL	58,50	1	079090805
XXXL	58,50	1	079090806
XXXXL	58,50	1	079090807

7909P

work jacket,
in T/C canvas, 260 g/m², with Oxford inserts,
petrol blue

CE

BetaEASY



SIZE	€	ST	ART
XS	58,50	1	079090600
S	58,50	1	079090601
M	58,50	1	079090602
L	58,50	1	079090603
XL	58,50	1	079090604
XXL	58,50	1	079090605
XXXL	58,50	1	079090606
XXXXL	58,50	1	079090607

7909V

work jacket,
in T/C canvas, 260 g/m², with Oxford inserts,
green

CE

BetaEASY



Size	€	Hand	Machine
XS	58,50	1	079090500
S	58,50	1	079090501
M	58,50	1	079090502
L	58,50	1	079090503
XL	58,50	1	079090504
XXL	58,50	1	079090505
XXXL	58,50	1	079090506
XXXXL	58,50	1	079090507

7939G

work jacket,
100% stretch cotton, 220 g/m²
Slim fit

CE

Cotton



Size	€	Hand	Machine
XS	62,00	1	079390300
S	62,00	1	079390301
M	62,00	1	079390302
L	62,00	1	079390303
XL	62,00	1	079390304
XXL	62,00	1	079390305
XXXL	62,00	1	079390306

7949

multi-protection work jacket,
T/C twill 250 g/m², blue,
for protection from heat, flames, electric arc
effects, welding hazards and chemicals.

CE

DPI: III^A Categoria
EN ISO 11611:2015 - Classe 1
EN ISO 11612:2015 - A1 B1 C1
EN 1149-5:2018
EN13034:2005+A1:2009 - Type 6
IEC 61482-2:2018 - APC 1



Size	€	Hand	Machine
XS	89,00	1	079490000
S	89,00	1	079490001
M	89,00	1	079490002
L	89,00	1	079490003
XL	89,00	1	079490004
XXL	89,00	1	079490005
XXXL	89,00	1	079490006
XXXXL	89,00	1	079490007

SLEEVELESS JACKETS



7575N

sleeveless softshell jacket,
90% nylon, 10% stretch fabric, 250 g/m²



Size	€	Hand	Machine
S	77,00	1	075750301
M	77,00	1	075750302
L	77,00	1	075750303
XL	77,00	1	075750304
XXL	77,00	1	075750305
XXXL	77,00	1	075750306

7579T

sleeveless work jacket, multipocket style,
made of waterproof 300D nylon, with stretch
inserts for ease of movement, black
Polyester padding, 140 g/m²



Size	€	Hand	Machine
S	61,00	1	075790001
M	61,00	1	075790002
L	61,00	1	075790003
XL	61,00	1	075790004
XXL	61,00	1	075790005
XXXL	61,00	1	075790006

7673NG

sleeveless work
jacket with GRAPHENE padding, 80 g/m²,
front reinforced in softshell fabric -
96% polyester, 4% spandex; back made
of 100% nylon 20D
anthracite grey (front), black (back)
Stretch insert on armhole
Antistatic, antibacterial, windproof

CE

TOP line



Size	€	Hand	Machine
S	85,00	1	076730001
M	85,00	1	076730002
L	85,00	1	076730003
XL	85,00	1	076730004
XXL	85,00	1	076730005
XXXL	85,00	1	076730006

7867G

sleeveless work jacket, lightweight,
in T/C twill, 180 g/m², with Oxford inserts, grey
New design - Improved fit

CE

BetaEASY

LIGHT



Size	€	Hand	Machine
XS	44,50	1	078670800
S	44,50	1	078670801
M	44,50	1	078670802
L	44,50	1	078670803
XL	44,50	1	078670804
XXL	44,50	1	078670805
XXXL	44,50	1	078670806
XXXXL	44,50	1	078670807

Beta

7907G

sleeveless work jacket,
in T/C canvas, 260 g/m², with Oxford inserts,
grey
New design - Improved fit

€ **Beta EASY**



SIZE	€	STOCK	ART. NO.
XS	48,50	1	079070800
S	48,50	1	079070801
M	48,50	1	079070802
L	48,50	1	079070803
XL	48,50	1	079070804
XXL	48,50	1	079070805
XXXL	48,50	1	079070806
XXXXL	48,50	1	079070807

7907P

sleeveless work jacket,
in T/C canvas, 260 g/m², with Oxford inserts,
petrol blue

€ **Beta EASY**



SIZE	€	STOCK	ART. NO.
XS	48,50	1	079070600
S	48,50	1	079070601
M	48,50	1	079070602
L	48,50	1	079070603
XL	48,50	1	079070604
XXL	48,50	1	079070605
XXXL	48,50	1	079070606
XXXXL	48,50	1	079070607

JACKETS



7658CM

softshell jacket,
94% polyester, 6% spandex, 290 g/m²,
camouflage grey
With waterproof, windproof, breathable
TPU membrane
(resistance to water columns up
to 8,000 mm - breathability 8,000 mvp)



SIZE	€	STOCK	ART. NO.
S	103,00	1	076580101
M	103,00	1	076580102
L	103,00	1	076580103
XL	103,00	1	076580104
XXL	103,00	1	076580105
XXXL	103,00	1	076580106

7658N

softshell jacket, 94% polyester, 6% spandex,
290 g/m², anthracite grey
With waterproof, windproof, breathable TPU
membrane (resistance to water columns up to
8,000 mm - breathability 8,000 mvp)



SIZE	€	STOCK	ART. NO.
S	92,50	1	076580001
M	92,50	1	076580002
L	92,50	1	076580003
XL	92,50	1	076580004
XXL	92,50	1	076580005
XXXL	92,50	1	076580006

7659N

softshell jacket, 94% polyester, 6% spandex,
290 g/m², with detachable hood and sleeves,
black With waterproof, windproof, breathable
TPU membrane (resistance to water columns
up to 8,000 mm - breathability 8,000 mvp)



SIZE	€	STOCK	ART. NO.
S	132,00	1	076590001
M	132,00	1	076590002
L	132,00	1	076590003
XL	132,00	1	076590004
XXL	132,00	1	076590005
XXXL	132,00	1	076590006

7669N

stretch work jacket, lightweight, multipocket
style, 86% nylon, 14% spandex, 140
g-m2, black
With detachable sleeves and retractable hood.
Water-resistant, wind-stopping



SIZE	€	STOCK	ART. NO.
XS	92,50	1	076690000
S	92,50	1	076690001
M	92,50	1	076690002
L	92,50	1	076690003
XL	92,50	1	076690004
XXL	92,50	1	076690005
XXXL	92,50	1	076690006

4-WAY STRETCH

Fabrics marked with the 4-Way
Stretch symbol stretch and regain
their shapes both widthwise and
lengthwise.

Based on this behaviour, they are
extremely elastic and comfortable,
to ensure the best fit and unparalleled
comfort, thereby resulting in total
freedom of movement in every
situation.

Hence they mean the ideal choice
for those who expect ultimate
performance from workwear.



Beta

7670G

Anorak jacket made of Oxford polyester 300D, waterproof, PU-coated, anthracite grey
With detachable hood and reinforced sleeves.
Waterproof, windproof and breathable (resistance to water columns up to 2,000 mm - breathability 2,000 mvp)
Polyester 210T lining, polyester padding, 120 g/m² body, 100 g/m² sleeves

CE **TOP**
line



	€		
S	92,50	1	076700001
M	92,50	1	076700002
L	92,50	1	076700003
XL	92,50	1	076700004
XXL	92,50	1	076700005
XXXL	92,50	1	076700006

7674NG

work quilted jacket with GRAPHENE padding, 80 g/m²,
front and forearms reinforced in softshell fabric - 96% polyester, 4% spandex, back and sleeves made of 100% nylon 20D anthracite grey (front), black (back) stretch cuffs
Antistatic, antibacterial, windproof

CE



TOP
line

	€		
S	103,00	1	076740001
M	103,00	1	076740002
L	103,00	1	076740003
XL	103,00	1	076740004
XXL	103,00	1	076740005
XXXL	103,00	1	076740006

Beta

7780T

work bomber jacket, multipocket style, made from waterproof nylon 300D, with stretch inserts for ease of movement, black
Polyester padding, 160 g/m², detachable hood



	€		
S	100,50	1	077800101
M	100,50	1	077800102
L	100,50	1	077800103
XL	100,50	1	077800104
XXL	100,50	1	077800105
XXXL	100,50	1	077800106

7904N

work bomber jacket, padded, made of T/C canvas, 270 g/m², "Oxford" inserts, black
Polyester padding, 140 g/m²

Beta EASY



	€		
XS	98,50	1	079040800
S	98,50	1	079040801
M	98,50	1	079040802
L	98,50	1	079040803
XL	98,50	1	079040804
XXL	98,50	1	079040805
XXXL	98,50	1	079040806
XXXXL	98,50	1	079040807

FLEECE



7634B

technical sweatshirt, long-zipped, 325 g/m², blue
67% polyester, 28% rayon, 5% spandex
3D fabric for improved breathability and freedom of movement



	€		
XS	76,00	1	076340200
S	76,00	1	076340201
M	76,00	1	076340202
L	76,00	1	076340203
XL	76,00	1	076340204
XXL	76,00	1	076340205
XXXL	76,00	1	076340206

7634G

technical sweatshirt, long-zipped, 325 g/m²
67% polyester, 28% rayon, 5% spandex
3D fabric for improved breathability and freedom of movement



	€		
XS	76,00	1	076340100
S	76,00	1	076340101
M	76,00	1	076340102
L	76,00	1	076340103
XL	76,00	1	076340104
XXL	76,00	1	076340105
XXXL	76,00	1	076340106

Beta

7635N

microfleece sweater, short-zipped, 180 g/m²
black



	€		
XS	30,50	1	076350500
S	30,50	1	076350501
M	30,50	1	076350502
L	30,50	1	076350503
XL	30,50	1	076350504
XXL	30,50	1	076350505
XXXL	30,50	1	076350506

7654B

stretch microfleece sweater, short-zipped, 180 g/m², blue
95% polyester, 5% spandex



	€		
XS	40,50	1	076540100
S	40,50	1	076540101
M	40,50	1	076540102
L	40,50	1	076540103
XL	40,50	1	076540104
XXL	40,50	1	076540105
XXXL	40,50	1	076540106

7654N

stretch microfleece sweater, short-zipped, 180 g/m², black
95% polyester, 5% spandex



	€		
XS	40,50	1	076540000
S	40,50	1	076540001
M	40,50	1	076540002
L	40,50	1	076540003
XL	40,50	1	076540004
XXL	40,50	1	076540005
XXXL	40,50	1	076540006

7657B

stretch fleece sweater, long-zipped, 280 g/m², blue
95% polyester, 5% spandex



	€		
XS	51,50	1	076570100
S	51,50	1	076570101
M	51,50	1	076570102
L	51,50	1	076570103
XL	51,50	1	076570104
XXL	51,50	1	076570105
XXXL	51,50	1	076570106

7657N

stretch fleece sweater, long-zipped, 280 g/m², black
95% polyester, 5% spandex



	€		
XS	51,50	1	076570000
S	51,50	1	076570001
M	51,50	1	076570002
L	51,50	1	076570003
XL	51,50	1	076570004
XXL	51,50	1	076570005
XXXL	51,50	1	076570006

7664C

sweatshirt, long-zipped, 280 g/m², grey
60% cotton, 40% polyester



	€		
XS	46,50	1	076640100
S	46,50	1	076640101
M	46,50	1	076640102
L	46,50	1	076640103
XL	46,50	1	076640104
XXL	46,50	1	076640105
XXXL	46,50	1	076640106

7664N

sweatshirt, long-zipped, 280 g/m², black
60% cotton, 40% polyester



	€		
XS	46,50	1	076640000
S	46,50	1	076640001
M	46,50	1	076640002
L	46,50	1	076640003
XL	46,50	1	076640004
XXL	46,50	1	076640005
XXXL	46,50	1	076640006

7665G

hoodie, long-zipped, 280 g/m², grey
60% cotton, 40% polyester



	€		
XS	50,50	1	076650100
S	50,50	1	076650101
M	50,50	1	076650102
L	50,50	1	076650103
XL	50,50	1	076650104
XXL	50,50	1	076650105
XXXL	50,50	1	076650106

7665N

hoodie, long-zipped, 280 g/m², black
60% cotton, 40% polyester



	€		
XS	50,50	1	076650000
S	50,50	1	076650001
M	50,50	1	076650002
L	50,50	1	076650003
XL	50,50	1	076650004
XXL	50,50	1	076650005
XXXL	50,50	1	076650006

SHIRT & T-SHIRT

7547BL

three-button polo shirt,
100% cotton, 200 g/m², blue



XS	€	5	1
XS	25,50	2	075470200
S	25,50	2	075470201
M	25,50	2	075470202
L	25,50	2	075470203
XL	25,50	2	075470204
XXL	25,50	2	075470205
XXXL	25,50	2	075470206

7547G

three-button polo shirt,
100% cotton, 200 g/m², grey



XS	€	5	1
XS	25,50	2	075470300
S	25,50	2	075470301
M	25,50	2	075470302
L	25,50	2	075470303
XL	25,50	2	075470304
XXL	25,50	2	075470305
XXXL	25,50	2	075470306

7547N

three-button polo shirt,
100% cotton, 200 g/m², black



XS	€	5	1
XS	25,50	2	075470400
S	25,50	2	075470401
M	25,50	2	075470402
L	25,50	2	075470403
XL	25,50	2	075470404
XXL	25,50	2	075470405
XXXL	25,50	2	075470406

7549BL

work t-shirt, 100% cotton, 150 g/m², blue



XS	€	5	1
XS	16,50	5	075490200
S	16,50	5	075490201
M	16,50	5	075490202
L	16,50	5	075490203
XL	16,50	5	075490204
XXL	16,50	5	075490205
XXXL	16,50	5	075490206

7549G

work t-shirt, 100% cotton, 150 g/m², grey



XS	€	5	1
XS	16,50	5	075490300
S	16,50	5	075490301
M	16,50	5	075490302
L	16,50	5	075490303
XL	16,50	5	075490304
XXL	16,50	5	075490305
XXXL	16,50	5	075490306

7549N

work t-shirt, 100% cotton, 150 g/m², black



XS	€	5	1
XS	16,50	5	075490400
S	16,50	5	075490401
M	16,50	5	075490402
L	16,50	5	075490403
XL	16,50	5	075490404
XXL	16,50	5	075490405
XXXL	16,50	5	075490406

7557BL

three-button polo shirt, long-sleeved,
100% cotton, 200 g/m², blue



XS	€	1	075570200
XS	30,00	1	075570200
S	30,00	1	075570201
M	30,00	1	075570202
L	30,00	1	075570203
XL	30,00	1	075570204
XXL	30,00	1	075570205
XXXL	30,00	1	075570206

RAIN

7970

waterproof trousers in PVC Tricot, blue



EN 343

XS	€	1	079700000
XS	39,50	1	079700000
S	39,50	1	079700001
M	39,50	1	079700002
L	39,50	1	079700003
XL	39,50	1	079700004
XXL	39,50	1	079700005
XXXL	39,50	1	079700006



7971L

waterproof trousers, made of PVC-coated polyester, with thermo-taped seams, blue
With elastic waistband and adjustable press-stud leg bottom

CE



EN 343

	€		
XS	22,00	1	079710100
S	22,00	1	079710101
M	22,00	1	079710102
L	22,00	1	079710103
XL	22,00	1	079710104
XXL	22,00	1	079710105
XXXL	22,00	1	079710106

7978L

waterproof full-length jacket, made of PVC-coated polyester, with fixed hood and thermo-taped seams, blue
Fitted with press studs for use as a 3/4 length jacket

CE



EN 343

	€		
XS	30,50	1	079780100
S	30,50	1	079780101
M	30,50	1	079780102
L	30,50	1	079780103
XL	30,50	1	079780104
XXL	30,50	1	079780105
XXXL	30,50	1	079780106

7979

waterproof jacket in PVC Tricot, blue

CE



EN 343

	€		
S	64,50	1	079790001
M	64,50	1	079790002
L	64,50	1	079790003
XL	64,50	1	079790004
XXL	64,50	1	079790005
XXXL	64,50	1	079790006

UNDERWEAR

7996N

technical underwear set - technical undershirt, long-sleeved + technical underpants, 92% polyester, 8% spandex, 160 g/m², black



	€		
XS-S	36,50	1	079960000
M-L	36,50	1	079960002
XL-XXL	36,50	1	079960004

ACCESSORIES

7800G

work knee pads pair



	€		
7800G	13,00	1	078000500

7980N

rainproof cap
100% PU-coated polyester
with water-repellent treatment



	€		
L = Ø 58 cm	11,00	1	079800058
XL = Ø 60 cm	11,00	1	079800060

7980NC

fleece winter cap, 100% polyester, reversible (double-faced), camouflage black



	€		
7980NC	11,50	10	079800112

7980R

cuffed winter cap, 100% acrylic, 3M Thinsulate™ padding, black



	€		
7980R	9,85	10	079800111

7984EG

stretch fabric work belt with satin-finished zinc metal hook buckle, one size; length: 120 cm, can be shortened; width: 37 mm, grey



7984EG	€ 22,40	1	079840520
--------	---------	---	-----------

7984G

work belt, 100% TPE, with chrome-plated zinc metal buckle one size fits all; length: 125 cm, can be shortened; width: 35 mm, black



7984G	€ 15,40	1	079840525
-------	---------	---	-----------

7985

neck warmer made of microfleece, with adjuster, black can also be used as a cap



7985	€ 11,60	10	079850111
------	---------	----	-----------

7104 90

plastic posts with fillable bases



7104 90	H mm 90	€ 23,80	4	071040004
---------	---------	---------	---	-----------

7105 6

plastic barrier chain



7105 6	Ø mm 6	L m 25	€ 57,00	1	071050006
--------	--------	--------	---------	---	-----------

7109A

aluminium warning signs



	H mm	€	1	071090001
7109A1	140	10,00	1	071090001
7109A2	140	10,00	1	071090002
7109A3	140	10,00	1	071090003
7109A4	140	10,00	1	071090004

7109D

prohibition signs



	H mm	€	1	071090051
7109D1	115	10,00	1	071090051
7109D2	115	10,00	1	071090052
7109D3	115	10,00	1	071090053

7195A

dust mask

CE



7195A	€ 5,60	10	071950004
-------	--------	----	-----------

7051MP

eye protector with polycarbonate visor

CE



7051MP	EN166	€ 8,05	5	070510001
--------	-------	--------	---	-----------

7061TC

safety glasses with clear polycarbonate lenses

CE

EASY



7061TC	EN166:2001 EN170 2C-1.2 1F	€ 8,20	1	070610001
--------	----------------------------------	--------	---	-----------

7076BC

safety glasses with clear polycarbonate lenses

CE

SPORT



7076BC	EN166:2001 EN172 5-1.7 1F	€ 18,70	1	070760009
--------	---------------------------------	---------	---	-----------

7076BD

safety glasses with polycarbonate lenses

CE SPORT



7076BD	EN166:2001 EN172 5-3.1 1F	€ 18,70	1	070760019
--------	---------------------------------	---------	---	-----------

7076BP

safety glasses with polarized polycarbonate lenses

CE SPORT



7076BP	EN ISO 12312-1:2013+A1:2015 EN 1836 3P	€ 29,50	1	070760029
--------	--	---------	---	-----------

7076BU

safety glasses with orange polycarbonate lenses

CE



7076BU	EN ISO 12311:2013 UV 500	€ 15,30	1	070760039
--------	-----------------------------	---------	---	-----------

7093BC

safety glasses with clear polycarbonate lenses

CE IMPACT



7093BC	EN166:2001 EN170 2C-1.2 1F	€ 28,00	1	070930009
--------	----------------------------------	---------	---	-----------

7093BD

safety glasses with dark polycarbonate lenses

CE IMPACT



7093BD	EN166:2001 EN172 5-3.1 1F	€ 28,00	1	070930019
--------	---------------------------------	---------	---	-----------

C62M/W
mannequin



C62M/W € 480,00 1 062000360

6200M/B

spare glass bases for mannequins C62M/W



6200M/B € 71,50 1 062000361

C64

wall display for clothing and footwear, empty



1 m	€ 1.163,00	1	064000021
2 m	€ 2.110,00	1	064000022
3 m	€ 3.050,00	1	064000023
4 m	€ 4.000,00	1	064000024

C64G

"gondola" display for clothing and footwear, empty



1 m	€ 1.440,00	1	064000051
2 m	€ 2.590,00	1	064000052

C64CW

dressing room



C64CW € 535,00 1 064000610

6200AP/S10

set of 10 hangers



6200AP/S10 € 38,50 1 062000331

6800BA



6800BA € 102,50 1 068000130

6800RS



6800RS € 88,00 1 068000135

6888GS

footwear hook for display C64



6888GS € 21,90 2 068880122
170x120 mm

6888GW

hook for display C64



6888GW € 5,70 2 068880121
400 mm

9562TB

mat for trying on shoes, with anti-skid, rubber-coated bottom



9562TB € 44,00 1 095620500

9565S

sheet steel drum with seat made of removable imitation leather



9565S € 193,00 2 095650300
h 60 cm - ø 38 cm

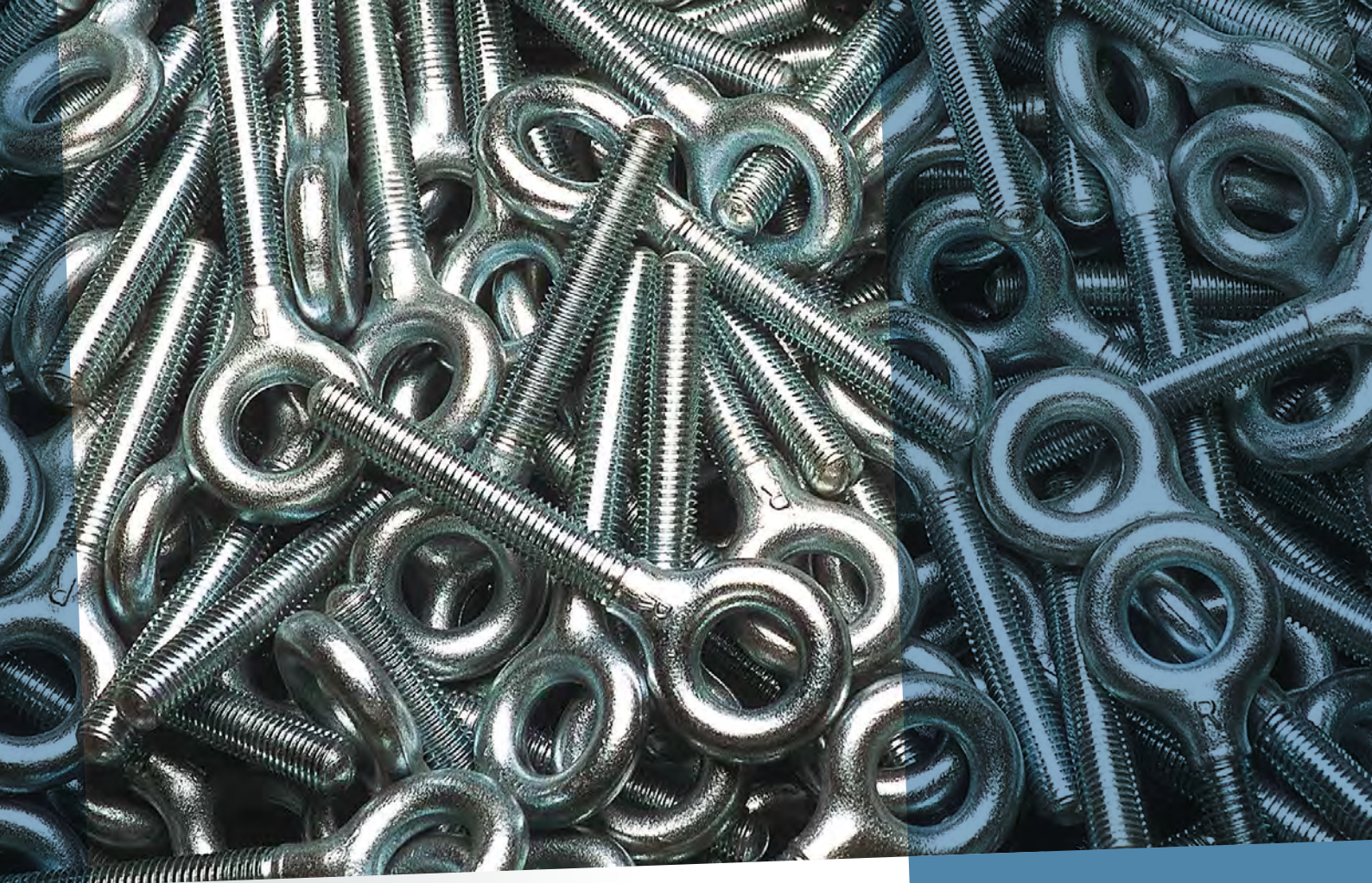

Robur

Since 1930 Robur has been manufacturing accessory lines for cables according to the acknowledged quality standards of Beta Utensili, whose products are complementary to those of Robur.

Expertise, organization and technology are the key ingredients of ongoing growth resulting from awareness of market requirements.

Since 1984 Robur has been headquartered in a state-of-the-art production facility in Sulmona.



Special free service boxes

MAXIMUM WORKING LOAD

WLL: working load limit (for lifting accessories)

WFL: workforce limit (for accessories other than lifting accessories)

BF: maximum force achieved by the item during the static traction test

LC: lashing capacity

8135

new item 2022

steel plate lifting clamps with articulated lifting eyes

CE



EN13155

TECHNICAL DATA

- Safety factor: 3
 - Serial number identification plate
- AVAILABLE CERTIFICATES
- Manufacturer's Certificate
 - CE Declaration of Conformity
 - Test report UNI EN10204 type 2.2
 - Technical product specifications

size	WLL t	A mm	h kg	price €	code number
	0,75	0-15	2	123,00	1 081350005
	1,0	0-20	5	166,00	1 081350010
	2,0	0-25	8	246,50	1 081350020
	3,0	0-30	15	418,00	1 081350032
n.° of tools per box	5,0	0-50	23	589,00	1 081350050

8105
eye and eye turnbuckles
high tensile steel, hot dip galvanized

CE



TECHNICAL DATA

- safety factor: 5
- heat treatment, body: normalizing
- heat treatment, eyes: hardening and tempering

LABORATORY TESTS

- chemical analysis
 - tensile test
 - proof load test 2 x WFL
- AVAILABLE CERTIFICATES**
- Technical product specifications
 - Test report UNI EN10204 type 2.2

ØxE "	≈ mm	WFL kg	€	⚙	🚚
3/8x6	M10x150	540	12,50	5	081050010
1/2x6	M12x150	1000	20,50	5	081050011
1/2x9	M12x230	1000	26,00	5	081050012
5/8x6	M16x150	1590	31,50	2	081050014
5/8x12	M16x300	1590	46,50	2	081050015
5/8x9	M16x230	1590	39,00	2	081050016
3/4x6	M20x150	2360	50,00	2	081050017
3/4x12	M20x300	2360	69,50	2	081050018
3/4x9	M20x230	2360	58,50	2	081050020
3/4x18	M20x460	2360	92,00	2	081050021
7/8x12	M22x300	3270	98,50	1	081050022
1x6	M24x150	4540	105,00	1	081050024
1x12	M24x300	4540	150,50	1	081050025
1.1/4x12	M33x300	6900	257,00	1	081050031
1.1/4x18	M33x460	6900	265,00	1	081050032
1.1/2x12	M39x300	9710	318,00	1	081050034
1.1/2x18	M39x460	9710	386,00	1	081050035
1.3/4x18	M45x460	12700	585,00	1	081050036

Other sizes available upon request

special free service boxes



ØxE "	⚙	€	🚚
3/8x6	1	13,60	081059010
1/2x9	1	27,50	081059012

Robur

8109
jaw and jaw turnbuckles
high tensile steel, hot dip galvanized

CE

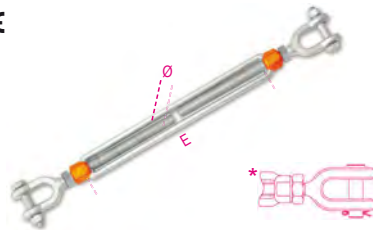

TECHNICAL DATA

- safety factor: 5
- heat treatment, body: normalizing
- heat treatment, jaws: hardening and tempering

LABORATORY TESTS

- chemical analysis
 - tensile test
- AVAILABLE CERTIFICATES**
- Technical product specifications
 - Test report UNI EN10204 type 2.2

ØxE "	≈ mm	WFL kg	€	⚙	🚚
3/8x6	M10x150	540	16,20	5	081090010
1/2x6	M12x150	1000	26,50	5	081090011
1/2x9	M12x230	1000	32,00	5	081090012
1/2x12	M12x300	1000	40,50	5	081090013
5/8x6	M16x150	1590	49,00	2	081090015
5/8x9	M16x230	1590	58,00	2	081090016
5/8x12	M16x300	1590	65,00	2	081090017
3/4x6	M20x150	2360	68,50	2	081090018
3/4x9	M20x230	2360	79,00	2	081090020
3/4x12	M20x300	2360	88,00	2	081090019
3/4x18	M20x460	2360	105,50	2	081090021
7/8x12	M22x300	3270	132,50	1	081090022
7/8x18	M22x460	3270	160,00	1	081090023
1x6	M24x150	4540	131,00	1	081090024
1x12	M24x300	4540	188,00	1	081090025
1x18	M24x460	4540	217,00	1	081090026
* 1.1/4x12	M33x300	6900	306,00	1	081090031
* 1.1/4x18	M33x460	6900	343,00	1	081090032
* 1.1/4x24	M33x610	6900	475,00	1	081090033
* 1.1/2x12	M39x300	9710	443,00	1	081090034
* 1.1/2x18	M39x460	9710	508,00	1	081090038
* 1.1/2x24	M39x610	9710	608,00	1	081090039
* 1.3/4x18	M45x460	12700	739,00	1	081090036

special free service boxes



ØxE "	⚙	€	🚚
3/8x6	1	17,30	081099010
1/2x9	1	33,00	081099012

8110
eye and jaw turnbuckles, high-tensile steel,
hot dip galvanized

CE



TECHNICAL DATA

- safety factor: 5
- turnbuckle body treatment: normalizing
- turnbuckle eye treatment: hardening and tempering

LABORATORY TESTS

- traceability code
 - chemical analysis
 - tensile test
- AVAILABLE CERTIFICATES**
- Technical product specifications
 - Test report UNI EN10204 type 2.2
 - Inspection certificate UNI EN10204 type 3.1
 - CE Declaration of Conformity

ØxE "	≈ mm	WFL kg	€	⚙	🚚
1/2x6	M12x150	1000	23,30	5	081100006
1/2x9	M12x230	1000	29,00	5	081100010
5/8x6	M16x150	1590	40,50	2	081100014
5/8x9	M16x230	1590	47,50	2	081100015
5/8x12	M16x300	1590	55,50	2	081100016
3/4x6	M20x150	2360	60,00	2	081100019
3/4x9	M20x230	2360	69,00	2	081100020
3/4x12	M20x300	2360	78,50	2	081100021
7/8x12	M22x300	3270	115,50	1	081100022
1x6	M24x150	4540	118,00	1	081100027
1x12	M24x300	4540	169,00	1	081100029
*1.1/4x12	M33x300	6900	282,00	1	081100034
*1.1/2x12	M39x300	9710	395,00	1	081100038
*1.1/2x18	M39x460	9710	449,00	1	081100039
*1.3/4x18	M45x460	12700	684,00	1	081100044

* Jaw with through pin and split pin

8005Z
eye and eye turnbuckles,
galvanized

CE

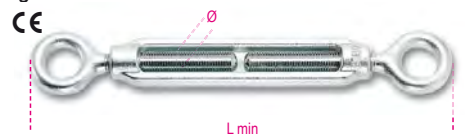

TECHNICAL DATA

- safety factor: 4
- LABORATORY TESTS**
- chemical analysis
 - tensile test
- AVAILABLE CERTIFICATES**
- Technical product specifications
 - Test report UNI EN10204 type 2.2
 - CE Declaration of Conformity

Ø mm	≈ "	L min mm	WFL kg	€	⚙	🚚
M5	3/16	118	115	2,05	400	080050105
M6	1/4	130	160	2,39	300	080050106
M8	5/16	158	300	3,60	200	080050108
M10	3/8	192	470	5,25	100	080050110
M11	7/16	206	580	6,95	80	080050111
M12	1/2	226	690	7,80	60	080050112
M14	9/16	256	940	10,90	15	080050114
M16	5/8	290	1290	16,20	10	080050116
M18	11/16	358	1660	25,00	1	080050118
M20	3/4	358	2130	28,00	1	080050120
M22	7/8	400	2630	36,50	1	080050122
M24	1"	436	3060	46,00	1	080050124
M27	1 1/8	474	4000	66,00	1	080050125
M30	1 3/16	498	4860	79,50	1	080050130
M33	1 1/4	516	6040	92,00	1	080050126
M36	1 3/8	532	6500	115,50	1	080050136
M39	1 1/2	544	7900	137,00	1	080050139

Whitworth thread subject to availability
New batches with metric thread

Robur

special packaging

Ø mm	≈	WFL kg	€	📦	🚚
M5	3/16	30	63,50	1	080050705
M6	1/4	30	70,00	1	080050706
M8	5/16	20	72,00	1	080050708
M10	3/8	15	77,00	1	080050710
M11	7/16	15	101,50	1	080050711
M12	1/2	15	119,00	1	080050712

special free service boxes



Ø mm	📦	€	🚚
M5	2	4,90	1 080059305
M6	2	5,55	1 080059306
M8	1	4,60	1 080059108
M10	1	6,10	1 080059110
M11	1	7,90	1 080059111
M12	1	8,85	1 080059112
M14	1	11,40	1 080059114
M16	1	17,00	1 080059116

8005T2

hot-forged eye and eye turnbuckles
pipe bodies,galvanized



TECHNICAL DATA

• safety factor: 4

LABORATORY TESTS

- chemical analysis
- tensile test

AVAILABLE CERTIFICATES

- Technical product specifications
- Test report UNI EN10204 type 2.2

• CE Declaration of Conformity

Ø mm	≈	WFL kg	€	📦	🚚
M12	1/2	690	10,70	15	080050512
M16	5/8	1290	18,00	1	080050516
M20	3/4	2130	28,50	1	080050520
M24	1"	3060	48,50	1	080050524
M27	1.1/8	4000	65,50	1	080050527
M30	1.3/16	4860	76,00	1	080050530
M36	1.3/8	6500	124,50	1	080050536

special free service boxes



Ø mm	📦	€	🚚
M12	1	12,50	1 080059512

8006Z

hook and eye turnbuckles,
galvanized

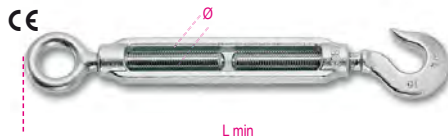

TECHNICAL DATA

• safety factor: 4

LABORATORY TESTS

- chemical analysis
- tensile test

AVAILABLE CERTIFICATES

- Technical product specifications
- Test report UNI EN10204 type 2.2
- CE Declaration of Conformity

Ø mm	≈	L min mm	WFL kg	€	📦	🚚
M5	3/16	121	25	2,15	400	080060105
M6	1/4	132	45	2,39	250	080060106
M8	5/16	170	95	3,65	180	080060108
M10	3/8	204	140	5,40	100	080060110
M11	7/16	221	165	7,30	15	080060111
M12	1/2	244	300	8,40	15	080060112
M14	9/16	284	420	12,40	10	080060114
M16	5/8	322	570	18,60	1	080060116
M18	11/16	373	700	27,50	1	080060118
M20	3/4	391	900	32,50	1	080060120
M22	7/8	433	1100	42,50	1	080060122
M24	1"	470	1300	57,50	1	080060124
M27	1"1/8	503	2300	77,50	1	080060127

special packaging

Ø mm	≈	WFL kg	€	📦	🚚
M5	3/16	30	67,50	1	080060705
M6	1/4	30	74,00	1	080060706
M8	5/16	20	76,00	1	080060708
M10	3/8	15	83,50	1	080060710

special free service boxes



Ø mm	📦	€	🚚
M5	2	5,50	1 080069305
M6	2	6,20	1 080069306
M8	1	4,70	1 080069108
M10	1	6,45	1 080069110
M11	1	8,30	1 080069111
M12	1	9,40	1 080069112
M14	1	13,40	1 080069114

8007Z

hook and hook turnbuckles,
galvanized

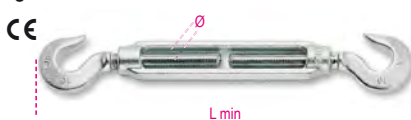

TECHNICAL DATA

• safety factor: 4

LABORATORY TESTS

- chemical analysis
- tensile test

AVAILABLE CERTIFICATES

- Technical product specifications
- Test report UNI EN10204 type 2.2
- CE Declaration of Conformity

Ø mm	≈	L min mm	WFL kg	€	📦	🚚
M5	3/16	124	25	2,39	30	080070105
M6	1/4	134	45	2,62	30	080070106
M8	5/16	181	95	3,90	20	080070108
M10	3/8	211	140	5,70	15	080070110
M11	7/16	231	165	7,70	15	080070111
M12	1/2	262	300	9,20	15	080070112

Ø mm	≈	L min mm	WFL kg	€	📦	🚚
M14	9/16	312	420	14,00	1	080070114
M16	5/8	354	570	20,90	1	080070116
M18	11/16	388	700	29,50	1	080070118
M20	3/4	424	900	37,00	1	080070120
M22	7/8	466	1100	47,00	1	080070122
M24	1"	504	1300	66,00	1	080070124
M27	1"1/8	532	2300	86,00	1	080070127

special free service boxes



Ø mm	📦	€	🚚
M5	2	5,80	1 080079305
M6	2	6,20	1 080079306
M8	1	4,65	1 080079108
M10	1	6,35	1 080079110
M11	1	8,55	1 080079111
M12	1	10,10	1 080079112

8008N

stub and stub turnbuckles
self-coloured

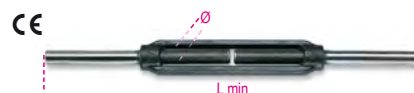

TECHNICAL DATA

• safety coefficient: 4

LABORATORY TESTS

- chemical analysis
- tensile test

AVAILABLE CERTIFICATES

- Technical product specifications
- Test report UNI EN10204 type 2.2
- CE Declaration of Conformity

Ø mm	≈	L min mm	WFL kg	€	📦	🚚
M5	3/16	160	115	2,00	30	080080205
M6	1/4	180	160	2,05	30	080080206
M8	5/16	210	300	2,96	20	080080208
M10	3/8	250	470	4,20	15	080080210
M12	1/2	280	690	5,75	15	080080212
M14	9/16	340	940	8,30	5	080080214
M16	5/8	380	1290	11,40	5	080080216
M18	11/16	410	1660	17,30	3	080080218
M20	3/4	440	2130	20,30	3	080080220
M22	7/8	480	2630	27,50	2	080080222
M24	1"	520	3060	31,50	2	080080224
M27	1"1/8	560	4000	51,50	1	080080227
M30	1"3/16	560	4860	65,00	1	080080230
M33	1"1/4	600	6040	69,00	1	080080233
M36	1"3/8	600	6500	87,50	1	080080236
M39	1"1/2	600	7900	101,50	1	080080239

Whitworth thread subject to availability

New batches with metric thread

special free service boxes



Ø mm	📦	€	🚚
M5	2	5,60	1 080089305
M6	2	5,70	1 080089306
M8	1	4,20	1 080089208
M10	1	5,50	1 080089210
M12	1	7,00	1 080089212
M14	1	9,85	1 080089214

Robur

8008TZ

stub and stub turnbuckles,
pipe bodies DIN 1478,
self-coloured terminals, galvanised bodies



TECHNICAL DATA

- safety factor: 4
- LABORATORY TESTS
- chemical analysis
- tensile test
- AVAILABLE CERTIFICATES
- Product specifications
- Test report type 2.2 UNI EN10204
- CE Declaration of Conformity

Ø mm	≈ "	WFL kg	€	📦	📄
M12	1/2	690	7,80	10	080080512
M16	5/8	1290	14,00	1	080080516
M20	3/4	2130	20,90	1	080080520
M24	1	3060	35,00	1	080080524
M27	1.1/8	4000	53,50	1	080080527
M30	1.3/16	4860	61,00	1	080080530
M36	1.3/8	6500	99,50	1	080080536

8009Z

jaw and jaw turnbuckles,
galvanized

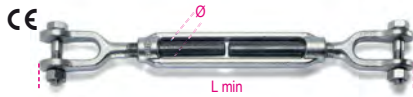

TECHNICAL DATA

- safety coefficient: 4
- LABORATORY TESTS
- chemical analysis
- tensile test
- AVAILABLE CERTIFICATES
- Technical product specifications
- Test report UNI EN10204 type 2.2
- CE Declaration of Conformity

Ø mm	≈ "	L min mm	WFL kg	€	📦	📄
M8	5/16	192	300	11,80	15	080090008
M10	3/8	234	470	13,90	15	080090010
M12	1/2	274	690	20,00	15	080090012
M14	9/16	342	940	28,00	1	080090014
M16	5/8	372	1290	33,00	1	080090016
M18	11/16	406	1660	47,00	1	080090018
M20	3/4	406	2130	50,00	1	080090020
M22	7/8	466	2630	68,50	1	080090022
M24	1"	486	3060	77,00	1	080090024
M27	1 1/8	510	4000	119,50	1	080090027
M30	1 3/16	566	4860	153,00	1	080090030

special free service boxes

Ø mm	📦	€	📄
M8	1	12,90	080099008
M10	1	14,80	080099010
M12	1	20,00	080099012

8009TZ

jaw and jaw turnbuckles,
pipe bodies, DIN 1478
galvanized



TECHNICAL DATA

- safety coefficient: 4
- LABORATORY TESTS
- chemical analysis
- tensile test
- AVAILABLE CERTIFICATES
- Technical Product Specifications
- Test Report UNI EN10204 type 2.2
- CE Declaration of Conformity

Ø mm	≈ "	WFL kg	€	📦	📄
M12	1/2	690	18,60	10	080090512
M16	5/8	1290	31,50	1	080090516
M20	3/4	2130	45,00	1	080090520
M24	1	3060	70,00	1	080090524
M27	1.1/8	4000	97,00	1	080090527
M30	1.3/16	4860	125,50	1	080090530

special free service boxes

Ø mm	📦	€	📄
M12	1	20,50	080099512

8010Z

eye and jaw turnbuckles,
galvanized



TECHNICAL DATA

- safety coefficient: 4
- LABORATORY TESTS
- chemical analysis
- tensile test
- AVAILABLE CERTIFICATES
- Technical product specifications
- Test report UNI EN10204 type 2.2
- CE Declaration of Conformity

Ø mm	≈ "	L min mm	WFL kg	€	📦	📄
M8	5/16	175	300	7,05	20	080100008
M10	3/8	215	470	8,95	15	080100010
M12	1/2	250	690	13,30	10	080100012
M14	9/16	299	940	18,40	10	080100014
M16	5/8	331	1290	24,20	1	080100016
M18	11/16	382	1660	36,00	1	080100018
M20	3/4	382	2130	40,00	1	080100020
M22	7/8	433	2630	54,00	1	080100022
M24	1"	461	3060	63,00	1	080100024
M27	1 1/8	492	4000	93,00	1	080100027
M30	1 3/16	529	4860	119,50	1	080100030

special free service boxes

Ø mm	📦	€	📄
M8	1	8,40	080109008
M10	1	10,40	080109010
M12	1	14,10	080109012
M14	1	20,00	080109014

8010TZ

eye and jaw turnbuckles,
pipe bodies DIN 1478,
galvanized



TECHNICAL DATA

- safety factor: 4
- LABORATORY TESTS • chemical analysis
- tensile test
- AVAILABLE CERTIFICATES
- Production specifications
- Test report type 2.2 UNI EN10204
- CE Declaration of Conformity

Ø mm	≈ "	WFL kg	€	📦	📄
M12	1/2	690	14,60	10	080100612
M16	5/8	1290	25,50	1	080100616
M20	3/4	2130	37,50	1	080100620
M24	1	3060	62,50	1	080100624
M27	1.1/8	4000	87,00	1	080100627
M30	1.3/16	4860	105,50	1	080100630

8001Z

turnbuckle bodies,
galvanized



TECHNICAL DATA

- safety factor: 4
- traceability code
- LABORATORY TESTS
- chemical analysis
- tensile test
- AVAILABLE CERTIFICATES
- Technical product specifications
- Test report UNI EN10204 type 2.2
- CE Declaration of Conformity

Ø mm	≈ "	L mm	WFL kg	€	📦	📄
M5	3/16	80	115	1,25	100	080010105
M6	1/4	80	160	1,30	100	080010106
M8	5/16	105	300	2,05	25	080010108
M10	3/8	125	470	2,62	20	080010110
M11	7/16	135	580	3,25	15	080010111
M12	1/2	140	690	3,50	20	080010112
M14	9/16	170	940	4,95	15	080010114
M16	5/8	190	1290	6,70	15	080010116
M18	11/16	205	1660	10,70	10	080010118
M20	3/4	220	2130	12,30	10	080010120
M22	7/8	240	2630	15,60	8	080010122
M24	1"	260	3060	19,00	5	080010124
M27	1 1/8	270	4000	30,00	1	080010127
M30	1 3/16	280	4860	37,50	1	080010130
M33	1 1/4	290	6040	41,50	1	080010133
M36	1 3/8	300	6500	53,50	1	080010136
M39	1 1/2	300	7900	64,00	1	080010139

Whitworth thread subject to availability
New batches with metric thread

special free service boxes

Ø mm	📦	€	📄
M5	2	3,75	080019305
M6	2	4,10	080019306
M8	1	3,25	080019108
M10	1	3,80	080019110
M11	1	4,55	080019111
M12	1	4,75	080019112
M14	1	6,35	080019114
M16	1	8,05	080019116
M18	1	11,90	080019118
M20	1	13,40	080019120
M22	1	16,90	080019122
M24	1	20,40	080019124

8001TZ

pipe turnbuckle bodies,
galvanized

CE



DIN 1478

TECHNICAL DATA

- safety factor: 4
- traceability code

LABORATORY TESTS

- chemical analysis
- tensile test

AVAILABLE CERTIFICATES

- Technical product specifications
- Test report UNI EN10204 type 2.2
- CE Declaration of Conformity

Ø mm	≈ "	L mm	WFL kg	€	📦	🚚
M12	1/2	125	690	5,80	10	080010512
M16	5/8	170	1290	8,85	5	080010516
M20	3/4	200	2130	11,70	5	080010520
M24	1	255	3060	20,50	3	080010524
M27	1 1/8	255	4000	27,50	1	080010527
M30	1 3/16	255	4860	31,00	1	080010530
M36	1 3/8	295	6500	56,00	1	080010536
M42	1 5/8	330	9700	79,00	1	080010542

* Sizes not contemplated by the standard

special free service boxes



Ø mm	📦	€	📦	🚚
M12	1	6,95	1	080019512
M16	1	9,85	1	080019516
M20	1	12,80	1	080019520
M24	1	21,30	1	080019524

8002ZD

turnbuckle eyes
right thread, galvanized

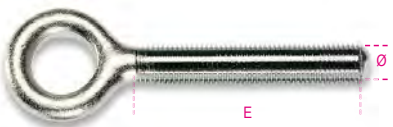

TECHNICAL DATA

- safety factor: 4

LABORATORY TESTS

- chemical analysis
- tensile test

AVAILABLE CERTIFICATES

- Technical product specifications
- Test report UNI EN10204 type 2.2

Ø mm	≈ "	E mm	WFL kg	€	📦	🚚
M5	3/16	37	115	0,43	200	080020105
M6	1/4	40	160	0,52	150	080020106
M8	5/16	52	300	0,78	100	080020108
M10	3/8	60	470	1,25	100	080020110
M11	7/16	65	580	1,76	1	080020111
M12	1/2	72	690	2,21	50	080020112
M14	9/16	85	940	2,72	1	080020114
M16	5/8	95	1290	4,55	1	080020116
M18	11/16	103	1660	6,70	1	080020118
M20	3/4	110	2130	7,50	1	080020120
M22	7/8	120	2630	10,90	1	080020122
M24	1"	130	3060	13,90	1	080020124
M27	1 1/8	135	4000	19,20	1	080020127
M30	1 3/16	140	4860	22,40	1	080020130
M33	1 1/4	148	6040	27,00	1	080020133
M36	1 3/8	150	6500	33,00	1	080020136
M39	1 1/2	150	7900	38,50	1	080020139

Whitworth thread subject to availability
New batches with metric thread

left-handed thread

Ø mm	≈ "	E mm	WFL kg	€	📦	🚚
M5	3/16	37	115	0,43	1	080020305
M6	1/4	40	160	0,52	1	080020306
M8	5/16	52	300	0,78	1	080020308
M10	3/8	60	470	1,25	1	080020310
M11	7/16	65	580	1,76	1	080020311
M12	1/2	72	690	2,21	1	080020312
M14	9/16	85	940	2,72	1	080020314
M16	5/8	95	1290	4,55	1	080020316
M18	11/16	103	1660	6,70	1	080020318
M20	3/4	110	2130	7,50	1	080020320
M22	7/8	120	2630	10,90	1	080020322
M24	1"	130	3060	13,90	1	080020324
M27	1 1/8	135	4000	19,20	1	080020327
M30	1 3/16	140	4860	22,40	1	080020330
M33	1 1/4	148	6040	27,00	1	080020333
M36	1 3/8	150	6500	33,00	1	080020336
M39	1 1/2	150	7900	38,50	1	080020339

8003ZD

turnbuckle hooks
right thread, galvanized

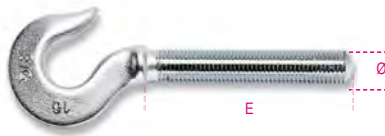

TECHNICAL DATA

- safety factor: 4

LABORATORY TESTS

- chemical analysis
- tensile test

AVAILABLE CERTIFICATES

- Technical product specifications
- Test report UNI EN10204 type 2.2

Ø mm	≈ "	E mm	WFL kg	€	📦	🚚
M5	3/16	40	25	0,57	150	080030105
M6	1/4	40	45	0,65	120	080030106
M8	5/16	52	95	0,96	100	080030108
M10	3/8	60	140	1,71	70	080030110
M11	7/16	65	165	2,33	1	080030111
M12	1/2	70	300	3,00	30	080030112
M14	9/16	85	420	4,55	1	080030114
M16	5/8	95	570	6,85	1	080030116
M18	11/16	103	700	9,20	1	080030118
M20	3/4	110	900	12,50	1	080030120
M22	7/8	120	1100	16,20	1	080030122
M24	1"	130	1300	24,70	1	080030124
M27	1 1/8	135	2300	29,50	1	080030127

left-handed thread

Ø mm	≈ "	WFL kg	E mm	€	📦	🚚
M5	3/16	40	25	0,57	1	080030305
M6	1/4	40	45	0,65	1	080030306
M8	5/16	52	95	0,96	1	080030308
M10	3/8	60	140	1,71	1	080030310
M11	7/16	65	165	2,33	1	080030311
M12	1/2	70	300	3,00	1	080030312
M14	9/16	85	420	4,55	1	080030314
M16	5/8	95	570	6,85	1	080030316
M18	11/16	103	700	9,20	1	080030318
M20	3/4	110	900	12,50	1	080030320
M22	7/8	120	1100	16,20	1	080030322
M24	1"	130	1300	24,70	1	080030324
M27	1 1/8	135	2300	29,50	1	080030327

8004ND

turnbuckle stubs
right-handed thread, self-coloured



TECHNICAL DATA

- safety factor: 4

LABORATORY TESTS

- chemical analysis
- tensile test

AVAILABLE CERTIFICATES

- Technical product specifications
- Test report UNI EN10204 type 2.2

Ø mm	≈ "	E mm	WFL kg	€	📦	🚚
M5	3/16	40	115	0,45	1	080040005
M6	1/4	44	160	0,52	1	080040006
M8	5/16	53	300	0,62	1	080040008
M10	3/8	63	470	0,91	1	080040010
M12	1/2	70	690	1,53	1	080040012
M14	9/16	85	940	2,10	1	080040014
M16	5/8	95	1290	2,89	1	080040016
M18	11/16	103	1660	3,95	1	080040018
M20	3/4	110	2130	4,95	1	080040020
M22	7/8	120	2630	6,10	1	080040022
M24	1"	130	3060	8,65	1	080040024
M27	1 1/8	135	4000	13,80	1	080040027
M30	1 3/16	140	4860	17,10	1	080040030
M33	1 1/4	150	6040	17,60	1	080040033
M36	1 3/8	150	6500	23,30	1	080040036
M39	1 1/2	150	7900	25,50	1	080040039

Whitworth thread subject to availability
New batches with metric thread

left-handed thread

Ø mm	≈ "	E mm	WFL kg	€	📦	🚚
M5	3/16	40	115	0,45	1	080040105
M6	1/4	44	160	0,52	1	080040106
M8	5/16	53	300	0,62	1	080040108
M10	3/8	63	470	0,91	1	080040110
M12	1/2	70	690	1,53	1	080040112
M14	9/16	85	940	2,10	1	080040114
M16	5/8	95	1290	2,89	1	080040116
M18	11/16	103	1660	3,95	1	080040118
M20	3/4	110	2130	4,95	1	080040120
M22	7/8	120	2630	6,10	1	080040122
M24	1"	130	3060	8,65	1	080040124
M27	1 1/8	135	4000	13,80	1	080040127
M30	1 3/16	140	4860	17,10	1	080040130
M33	1 1/4	150	6040	17,60	1	080040133
M36	1 3/8	150	6500	23,30	1	080040136
M39	1 1/2	150	7900	25,50	1	080040139



8009FD

turnbuckle jaws
right-handed thread, galvanized



TECHNICAL DATA

- safety factor: 4
- LABORATORY TESTS
- chemical analysis
- tensile test

AVAILABLE CERTIFICATES

- Technical product specifications
- Test report UNI EN10204 type 2.2

Ø mm	≈ "	E mm	WFL kg	€	📦	🚚
M8	5/16	53	300	4,85	1	080090208
M10	3/8	63	470	5,70	1	080090210
M12	1/2	70	690	7,70	1	080090212
M14	9/16	85	940	10,70	1	080090214
M16	5/8	95	1290	12,10	1	080090216
M18	11/16	103	1660	17,10	1	080090218
M20	3/4	110	2130	17,60	1	080090220
M22	7/8	120	2630	25,50	1	080090222
M24	1"	130	3060	29,00	1	080090224
M27	1 1/8	135	4000	45,50	1	080090227
M30	1 3/16	140	4860	59,00	1	080090230

left-handed thread

Ø mm	≈ "	WFL kg	G mm	€	📦	🚚
M8	5/16	53	300	4,85	1	080090408
M10	3/8	63	470	5,70	1	080090410
M12	1/2	70	690	7,70	1	080090412
M14	9/16	85	940	10,70	1	080090414
M16	5/8	95	1290	12,10	1	080090416
M18	11/16	103	1660	17,10	1	080090418
M20	3/4	110	2130	17,60	1	080090420
M22	7/8	120	2630	25,50	1	080090422
M24	1"	130	3060	29,00	1	080090424
M27	1 1/8	135	4000	45,50	1	080090427
M30	1 3/16	140	4860	59,00	1	080090430

8048

eye tie rods right thread
self-coloured



UNI 6058

ØxL mm	WFL kg	F mm	€	📦	🚚
M8x50	430	6	3,05	20	080480108
M8x65	430	6	3,25	20	080480109
M10x80	690	8	5,05	10	080480110
M10x100	690	8	5,05	10	080480210
M10x130	690	8	5,70	10	080480111
M12x95	1020	10	5,25	8	080480212
M12x95	1020	10	5,40	8	080480112
M12x125	1020	10	6,55	8	080480113
M14x110	1420	12	7,40	6	080480114
M16x100	1980	14	6,10	6	080480115
M16x130	1980	14	6,35	6	080480116
M18x150	2390	16	14,30	2	080480118
M20x160	3100	18	17,60	2	080480120
M22x180	3890	18	27,50	1	080480122
M24x200	4460	20	31,50	1	080480124
M24x220	4460	20	34,00	1	080480125
M27x220	5900	22	41,00	1	080480127

8302Z

fastening eye bolts,
right thread, galvanized

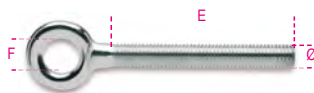

TECHNICAL DATA

- safety factor: 4
- AVAILABLE CERTIFICATES
- Technical product specifications
- Test report UNI EN10204 type 2.2

Ø mm	E mm	F mm	WFL kg	€	📦	🚚
M5	48	8	115	0,49	200	083020005
M6	55	10	160	0,59	150	083020006
M8	60	12	300	0,80	100	083020008
M10	73	14	470	1,36	100	083020010
M12	90	17	690	2,62	50	083020012

8303Z

fastening hooks
right thread, galvanized



TECHNICAL DATA

- safety factor: 4
- AVAILABLE CERTIFICATES
- Technical product specifications
- Test report UNI EN10204 type 2.2

Ø mm	C mm	E mm	WFL kg	€	📦	🚚
M5	6,0	48	25	0,57	120	083030005
M6	8,0	55	45	0,62	100	083030006
M8	10,0	60	95	1,01	75	083030008
M10	12,5	73	140	1,71	50	083030010
M12	16,0	90	220	2,84	20	083030012

8702N - 8702Z - 8702ZC

swage sockets made from forged steel

closed
black



TECHNICAL DATA

- traceability code
- LABORATORY TESTS
- chemical analysis
- tensile test
- AVAILABLE CERTIFICATES
- Technical product specifications
- Test report UNI EN10204 type 2.2
- Inspection certificate UNI EN10204 type 3.1

M	ØB mm	ØA mm	ØD mm	€	📦	🚚
6	6,8	13	19	41,00	1	087020106
8	8,8	20	22	49,50	1	087020108
9	9,8	20	22	49,50	1	087020109
10	10,8	20	22	49,50	1	087020110
11	11,8	25	27	61,00	1	087020111
12	12,8	25	27	61,00	1	087020112
13	13,8	25	27	61,00	1	087020113
14	14,8	32	32	85,00	1	087020114
15	15,9	32	32	85,00	1	087020115
16	17,0	32	32	85,00	1	087020116
18	19,0	39	37	110,00	1	087020118
19	20,0	39	37	110,00	1	087020119
20	21,1	39	37	110,00	1	087020120
22	23,2	43	43	153,00	1	087020122
24	25,4	50	52	176,00	1	087020124
25	26,4	50	52	176,00	1	087020125
26	27,4	50	52	176,00	1	087020126

Socket swaging requires suitable presses and dies and can only be performed by trained staff.

8702Z galvanized

M	ØB mm	ØA mm	ØD mm	€	📦	🚚
6	6,8	13	19	43,00	1	087020306
8	8,8	20	22	52,00	1	087020308
9	9,8	20	22	52,00	1	087020309
10	10,8	20	22	52,00	1	087020310
11	11,8	25	27	64,00	1	087020311
12	12,8	25	27	64,00	1	087020312
13	13,8	25	27	64,00	1	087020313
14	14,8	32	32	89,00	1	087020314
15	15,9	32	32	89,00	1	087020315
16	17,0	32	32	89,00	1	087020316
18	19,0	39	37	115,50	1	087020318
19	20,0	39	37	115,50	1	087020319
20	21,1	39	37	115,50	1	087020320
22	23,2	43	43	153,00	1	087020322
24	25,4	50	52	184,00	1	087020324
25	26,4	50	52	184,00	1	087020325
26	27,4	50	52	184,00	1	087020326

8702ZC hot-dip galvanized

M	ØB mm	ØA mm	ØD mm	€	📦	🚚
6	6,8	13	19	45,50	1	087020206
8	8,8	20	22	56,00	1	087020208
9	9,8	20	22	56,00	1	087020209
10	10,8	20	22	56,00	1	087020210
11	11,8	25	27	69,50	1	087020211
12	12,8	25	27	69,50	1	087020212
13	13,8	25	27	69,50	1	087020213
14	14,8	32	32	103,00	1	087020214
15	15,9	32	32	103,00	1	087020215
16	17,0	32	32	103,00	1	087020216
18	19,0	39	37	133,00	1	087020218
19	20,0	39	37	133,00	1	087020219
20	21,1	39	37	133,00	1	087020220
22	23,2	43	43	180,50	1	087020222
24	25,4	50	52	211,00	1	087020224
25	26,4	50	52	211,00	1	087020225
26	27,4	50	52	211,00	1	087020226



8709N - 8709Z - 8709ZC

swage sockets made from forged steel open black



TECHNICAL DATA

• traceability code

LABORATORY TESTS

• chemical analysis
• tensile test

AVAILABLE CERTIFICATES

• Technical product specifications
• Test report UNI EN10204 type 2.2
• Inspection certificate UNI EN10204 type 3.1

M	Ø B mm	Ø A mm	Ø C mm	€		
6	6,8	13	17	56,00	1	087090106
8	8,8	20	21	73,00	1	087090108
9	9,8	20	21	73,00	1	087090109
10	10,8	20	21	73,00	1	087090110
11	11,8	25	25	91,00	1	087090111
12	12,8	25	25	91,00	1	087090112
13	13,8	25	25	91,00	1	087090113
14	14,8	32	30	126,50	1	087090114
15	15,9	32	30	126,50	1	087090115
16	17,0	32	30	126,50	1	087090116
18	19,0	39	35	164,50	1	087090118
19	20,0	39	35	164,50	1	087090119
20	21,1	39	35	164,50	1	087090120
22	23,2	43	41	210,00	1	087090122
24	25,4	50	51	216,00	1	087090124
25	26,4	50	51	216,00	1	087090125
26	27,4	50	51	216,00	1	087090126

Socket swaging requires suitable presses and dies and can only be performed by trained staff.

8709Z galvanized

M	Ø B mm	Ø A mm	Ø C mm	€		
6	6,8	13	17	58,00	1	087090306
8	8,8	20	21	76,00	1	087090308
9	9,8	20	21	76,00	1	087090309
10	10,8	20	21	76,00	1	087090310
11	11,8	25	25	95,00	1	087090311
12	12,8	25	25	95,00	1	087090312
13	13,8	25	25	95,00	1	087090313
14	14,8	32	30	133,00	1	087090314
15	15,9	32	30	133,00	1	087090315
16	17,0	32	30	133,00	1	087090316
18	19,0	39	35	172,50	1	087090318
19	20,0	39	35	172,50	1	087090319
20	21,0	39	35	172,50	1	087090320
22	23,2	43	41	226,00	1	087090322
24	25,4	50	51	226,00	1	087090324
25	26,4	50	51	226,00	1	087090325
26	27,4	50	51	226,00	1	087090326

8709ZC hot-dip galvanized

M	Ø B mm	Ø A mm	Ø C mm	€		
6	6,8	13	17	60,00	1	087090206
8	8,8	20	21	80,00	1	087090208
9	9,8	20	21	80,00	1	087090209
10	10,8	20	21	80,00	1	087090210
11	11,8	25	25	103,50	1	087090211
12	12,8	25	25	103,50	1	087090212
13	13,8	25	25	103,50	1	087090213
14	14,8	32	30	150,00	1	087090214
15	15,9	32	30	150,00	1	087090215
16	17,0	32	30	150,00	1	087090216
18	19,0	39	35	191,50	1	087090218
19	20,0	39	35	191,50	1	087090219
20	21,1	39	35	191,50	1	087090220
22	23,2	43	41	244,00	1	087090222
24	25,4	50	51	269,00	1	087090224
25	26,4	50	51	269,00	1	087090225
26	27,4	50	51	269,00	1	087090226

8015

wire rope clips, American type, steel body, hot-dip galvanized

CE

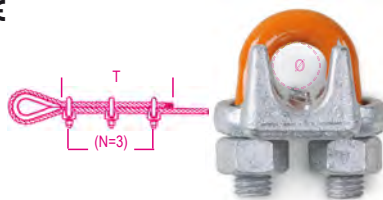

dimensioni EN 13411-5 tipo B

TECHNICAL DATA

• traceability code

LABORATORY TESTS

• chemical analysis

• torque test

AVAILABLE CERTIFICATES

• Technical product specifications
• Test report UNI EN10204 type 2.2
• Manufacturer's Certificate UNI EN13411-5
• CE Declaration of Conformity

Ø mm	Ø "	NxT	Nm	€		
8	5/16	3x133	40,7	2,05	12	080150808
10	3/8	3x165	61	2,84	12	080150810
13	1/2	3x292	88	4,45	6	080150813
16	5/8	3x305	129	6,25	6	080150816
20	3/4	4x460	176	8,55	6	080150820
22	7/8	4x480	305	13,60	6	080150822
26	1	5x660	305	14,80	5	080150826
30	1-1/8	6x860	305	15,80	2	080150830

8016

wire rope clips, hot forged steel body, galvanized

CE

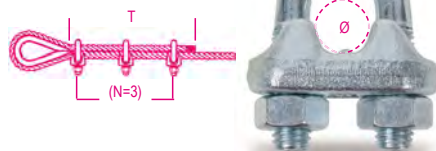

TECHNICAL DATA

• chemical analysis

• torque test

AVAILABLE CERTIFICATES

• Technical product specifications
• Test report UNI EN10204 type 2.2
• CE Certificate of Conformity

Ø mm	Ø "	NxT	Nm	€		
3	1/8	3x80	1,53	0,55	500	080160003
5	3/16	3x110	3,02	0,70	300	080160005
6	1/4	3x120	5,19	0,78	200	080160006
8	5/16	5x210	5,19	0,96	150	080160008
10	3/8	5x240	12,54	1,45	70	080160010
11	7/16	5x260	12,54	1,56	70	080160011
12-13	1/2	5x300	24,76	2,09	40	080160013
14	9/16	5x240	24,76	2,27	35	080160014
16	5/8	5x335	24,76	2,67	30	080160016
18	11/16	5x380	42,42	3,60	30	080160018
20	3/4	5x540	42,42	3,95	30	080160020
22	7/8	7x595	42,42	4,55	25	080160022
24-26	1"	7x700	67,56	6,35	15	080160026
28	1 1/16	8x840	67,56	7,85	5	080160028
30-32	1 1/8	8x990	67,56	7,90	5	080160030
34-36	1 1/4	8x1155	105,80	10,50	4	080160034
38-40	1 1/2	8x1320	105,80	14,10	2	080160040
45-50	2"	8x1500	206	21,80	1	080160050

special packaging

Ø mm	"	Ø	€		
3	1/8	100	55,00	1	080160703
5	3/16	50	35,00	1	080160705
6	1/4	50	39,00	1	080160706
8	5/16	30	29,00	1	080160708
10	3/8	30	43,50	1	080160710
11	7/16	25	39,00	1	080160711
12-13	1/2	15	31,50	1	080160713

special free service boxes

Ø mm	Ø	€		
3	6	4,15	1	080169403
5	4	3,65	1	080169405
6	4	4,10	1	080169406
8	4	4,75	1	080169408
10	2	3,80	1	080169410
11	1	2,78	1	080169011
12-13	1	3,25	1	080169013
14	1	3,45	1	080169014
16	1	3,80	1	080169016
18	1	4,85	1	080169018
20	1	4,95	1	080169020
22	1	5,80	1	080169022
24-26	1	7,60	1	080169026

8016FR

wire rope clips, cold pressed steel body, galvanized

CE

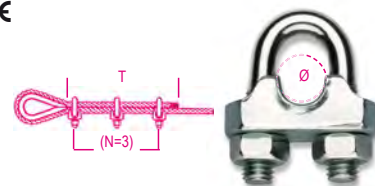

LABORATORY TESTS

• chemical analysis

AVAILABLE CERTIFICATES

• Technical product specifications
• Test report UNI EN10204 type 2.2
• CE Certificate of Conformity

Ø mm	Ø "	NxT	Nm	€		
3	1/8	3x80	1,25	0,51	500	080160253
5	3/16	3x110	2,46	0,61	300	080160255
6	1/4	3x120	4,24	0,73	200	080160256
8	5/16	5x210	4,24	0,86	150	080160258

special free service boxes

Ø mm	Ø	€		
3	6	4,45	1	080169753
5	6	3,90	1	080169755
6	4	4,35	1	080169756
8	4	4,60	1	080169758

Robur

8018E

wire rope clips, ENEL type,
hot forged steel body, hot-dip galvanized
U-bolts and nuts with chemical galv. protection



LABORATORY TESTS

- chemical analysis

AVAILABLE CERTIFICATES

- Technical product specifications
- Test report UNI EN10204 type 2.2

Ø	A	L	Nm	€		
mm	mm	mm				
4÷6	M6	34	4,24	1,11	100	080180001

8016U2

wire rope clips
malleable cast iron body
galvanized

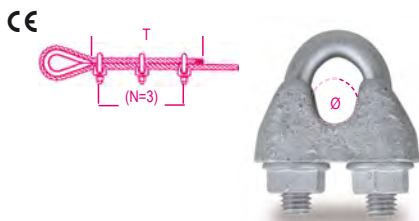

dimensioni EN 13411-5 tipo A

TECHNICAL DATA

- traceability code

LABORATORY TESTS

- chemical analysis
- torque test

AVAILABLE CERTIFICATES

- Technical product specifications
- Test report UNI EN10204 type 2.2
- Manufacturer's Certificate UNI EN13411-5
- CE Certificate of Conformity

Ø	Ø"	N x T	Nm	€		
mm						
5	3/16	3x156	2,0	0,30	300	080160855
6,5	1/4	3x192	3,5	0,41	150	080160856
8	5/16	4x320	6	0,83	70	080160858
10	3/8	4x320	9	0,87	60	080160860
12	1/2	4x384	20	1,65	25	080160862
14	9/16	4x448	33	2,56	15	080160864
16	5/8	4x512	49	3,80	10	080160866
19	3/4	4x512	68	4,45	10	080160869
22	7/8	5x680	107	6,35	10	080160872
26	1	5x760	147	11,40	5	080160876
30	1.1/8	6x984	212	14,70	5	080160880
34	1.1/4	6x1080	296	20,10	5	080160884
40	1.1/2	6x1176	363	24,90	5	080160890

special free service boxes

Ø	€		
mm			
5	3,60	1	080169805
6	4,55	1	080169806
8	7,05	1	080169808
10	4,75	1	080169810
12	4,55	1	080169612
14	5,25	1	080169614
16	7,05	1	080169616
19	7,70	1	080169619
22	10,00	1	080169622
26	16,50	1	080169626

8016UGK

wire rope clips,
made of malleable cast iron,
HOT DIP GALVANIZED body,
GEOMET-GEOKOTE U-bolts and nuts

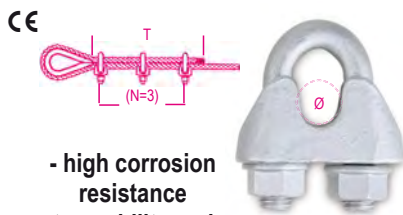

- high corrosion resistance
- traceability code

dimensioni EN 13411-5 tipo A

TECHNICAL DATA

- traceability code

LABORATORY TESTS

- chemical analysis
- torque test

AVAILABLE CERTIFICATES

- Technical product specifications
- Test report UNI EN10204 type 2.2
- Manufacturer's Certificate UNI EN13411-5
- CE Declaration of conformity

Ø	Ø"	N x T	Nm	€		
mm						
8	5/16	4x320	6	1,65	70	080160758
10	3/8	4x320	9	1,82	60	080160760
12	1/2	4x448	33	3,25	25	080160762
14	9/16	4x384	20	4,75	15	080160764
16	5/8	4x512	49	7,05	10	080160766
19	3/4	4x512	68	7,90	10	080160769
22	7/8	5x680	107	11,40	10	080160772
26	1	5x760	147	18,70	5	080160776
30	1.1/8	6x984	212	22,70	1	080160780
34	1.1/4	6x1080	296	32,00	1	080160784
40	1.1/2	6x1176	363	40,00	1	080160790

8018T

wire rope clips, TELECOM type
malleable cast iron body
galvanized



RUM-MU-21:1980

LABORATORY TESTS

- chemical analysis

AVAILABLE CERTIFICATES

- Technical product specifications
- Test report UNI EN10204 type 2.2

Ø	A	L	Nm	€		
mm	mm	mm				
8÷10	M8	42	10,20	1,14	200	080180003

8020A

thimbles, Italian light type,
galvanized

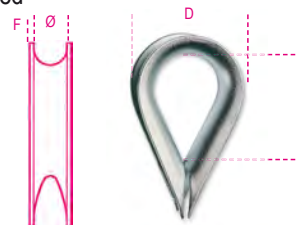

AVAILABLE CERTIFICATES

- Technical product specifications
- Test report UNI EN10204 type 2.2

Ø	F	B	D	€		
mm	mm	mm	mm			
2-3	1,0	20	18	0,21	150	080200503
4	1,2	23	19	0,22	150	080200504
5	1,2	24	23	0,25	100	080200505
6	1,2	27	28	0,26	100	080200506
8	1,4	33	32	0,41	50	080200508
10	1,8	41	38	0,60	30	080200510
12	2,2	44	45	0,79	30	080200512
14	2,2	52	49	1,01	50	080200514
16	3,0	58	58	1,42	50	080200516
18	3,7	64	68	2,00	50	080200518
20	3,7	73	74	2,59	35	080200520
22	3,7	83	79	2,89	30	080200522
24	3,7	93	88	3,80	20	080200525

special packaging

Ø	S	€			
mm	mm				
2-3	0,8	150	28,50	1	080200703
4	1,0	150	30,00	1	080200704
5	1,0	100	23,00	1	080200705
6	1,0	100	24,00	1	080200706
8	1,2	50	19,00	1	080200708
10	1,5	30	16,50	1	080200710

8021

thimbles, heavy type,
galvanized

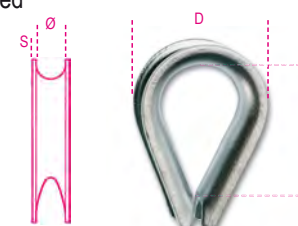

AVAILABLE CERTIFICATES

- Technical product specifications
- Test report UNI EN10204 type 2.2

Ø	S	B	D	€		
mm	mm	mm	mm			
2-3	0,6	15	16	0,33	150	080210003
5	1,7	29	28	0,49	120	080210005
6	1,8	33	30	0,53	100	080210006
8	2,5	36	37	0,72	100	080210008
10	2,5	42	43	0,89	80	080210010
12	2,5	48	50	1,14	100	080210012
14	2,7	58	57	1,53	70	080210014
16	3,0	61	62	1,87	50	080210016
18	3,5	71	71	2,44	70	080210018
20	4,0	79	79	3,60	60	080210020
22	4,0	87	84	4,20	50	080210022
24	4,0	93	92	4,95	40	080210024
26	4,0	103	103	6,10	35	080210026
28	5,0	107	116	14,30	1	080210028
30	5,0	118	121	14,30	1	080210030
32	5,5	138	135	17,10	1	080210032
35	6,0	140	147	23,90	1	080210035
40	6,0	174	170	34,00	1	080210140

8026R

straight shackles with screw collar pin, high-tensile alloy steel, GRADE 6, hot-dipped galvanized body

CE



EN 13889
GRADE 6

TECHNICAL DATA

- minimum safety factor: 6
 - heat treatment: hardening and tempering
 - traceability code on both pin and body
- LABORATORY TESTS
- chemical analysis • metallographic analysis
 - tensile test • fatigue test (min. 20,000 cycles)
 - proof load test (2 x WLL)

AVAILABLE CERTIFICATES

- Technical Product Specifications
- Test Report UNI EN10204 type 2.2
- Inspection Certificate UNI EN10204 type 3.1
- CE Declaration of Conformity

ØD mm	ØA mm	H mm	WLL kg	€	📦	🚚
11	10	17	1000	5,50	5	080260210
16	13	21	2000	10,30	5	080260212
19	16	27	3250	17,40	3	080260216
22	19	32	4750	25,50	2	080260219
25	22	37	6500	38,50	2	080260222

special free service boxes



ØD mm	📦	€	🚚
16	1	11,20	1
19	1	18,70	1

8029R

bow shackles with screw collar pins, high-tensile alloy steel, GRADE 6, hot-dipped galvanized body

CE



EN 13889
GRADO 6

TECHNICAL DATA

- minimum safety factor: 6
- heat treatment: hardening and tempering
- traceability code on pin and body

LABORATORY TESTS

- chemical analysis
- metallographic analysis
- tensile test
- fatigue test (min. 20,000 cycles)
- proof load test (2 x WLL)

AVAILABLE CERTIFICATES

- Technical Product Specifications
- Test Report UNI EN10204 type 2.2
- Inspection Certificate UNI EN10204 type 3.1
- CE Declaration of Conformity

ØD mm	ØA mm	H mm	WLL kg	€	📦	🚚
8	6	13	500	3,40	20	080290106
10	8	13,5	750	4,10	15	080290108
11	10	17	1000	5,80	15	080290110
13	11	18,5	1500	7,70	10	080290111
16	13	20,5	2000	7,90	8	080290112
19	16	27	3250	13,60	5	080290116
22	19	32	4750	20,00	2	080290120
25	22	37	6500	30,00	2	080290122
28	26	43,5	8500	41,00	1	080290124

ØD mm	ØA mm	H mm	WLL kg	€	📦	🚚
32	29	48	9500	76,50	1	080290128
35	32	53	12000	102,50	1	080290132
38	35	59	13500	135,00	1	080290135
42	38	62	17000	176,00	1	080290138
50	45	75	25000	301,00	1	080290145
57	50	83	35000	528,00	1	080290150
65	57	95	42500	909,00	1	080290157
70	65	105	55000	1.039,00	1	080290165

special free service boxes



ØD mm	📦	€	🚚
8	1	4,55	1
10	1	5,25	1
11	1	7,05	1
13	1	8,95	1
16	1	9,10	1
19	1	15,30	1

8031R

bow shackles with safety bolt, EN13889 high-tensile alloy steel, GRADE 6, hot-dip galvanized body

CE



EN 13889
GRADO 6

TECHNICAL DATA

- minimum safety factor: 6
- heat treatment: hardening and tempering
- traceability code on pin and body

LABORATORY TESTS

- chemical analysis
- metallographic analysis
- tensile test
- fatigue test (min. 20,000 cycles)
- proof load test (2 x WLL)

AVAILABLE CERTIFICATES

- Technical Product Specifications
- Test Report UNI EN10204 type 2.2
- Inspection Certificate UNI EN10204 type 3.1
- CE Declaration of Conformity

ØD mm	ØA mm	H mm	WLL kg	€	📦	🚚
11	10	17	1000	6,25	5	080310110
13	11	18	1500	9,65	5	080310111
16	13	21	2000	9,85	5	080310112
19	16	27	3250	16,80	3	080310116
22	19	32	4750	23,90	2	080310120
25	22	37	6500	33,00	2	080310122
28	26	43	8500	49,00	1	080310124
32	29	48	9500	84,00	1	080310128
35	32	53	12000	108,50	1	080310132
38	35	59	13500	153,00	1	080310135
42	38	62	17000	186,50	1	080310138
50	45	75	25000	327,00	1	080310145
57	50	83	35000	573,00	1	080310150
70	65	105	55000	1.170,00	1	080310165
83	75	127	85000	1.780,00	1	080310183

special free service boxes



ØD mm	📦	€	🚚
16	1	12,10	1
19	1	20,50	1

8032

bow shackles with square sunken hole screw pin, high-tensile alloy steel, GRADE 6, hot-dip galvanized body

CE



GRADE 6

TECHNICAL DATA

- minimum safety factor: 6
- heat treatment: hardening and tempering
- traceability code on pin and body

LABORATORY TESTS

- chemical analysis
- metallographic analysis
- tensile test
- fatigue test (min. 20,000 cycles)
- proof load test (2 x WLL)

AVAILABLE CERTIFICATES

- Technical Product Specifications
- Test Report UNI EN10204 type 2.2
- Inspection Certificate UNI EN10204 type 3.1
- CE Declaration of Conformity

ØD mm	ØA mm	H mm	WLL kg	€	📦	🚚
11	10	17	1000	7,40	5	080320010
16	13	21	2000	9,40	5	080320012
19	16	27	3250	17,00	3	080320016
22	19	32	4750	29,50	2	080320020
25	22	37	6500	43,00	2	080320022

special free service boxes



ØD mm	📦	€	🚚
16	1	11,20	1
19	1	18,70	1

8025

lifting LARGE DEE shackles, hot forged carbon steel, galvanized

CE



GRADO 4

TECHNICAL DATA

- safety factor: 5 • heat treatment: normalizing
- traceability code

LABORATORY TESTS

- chemical analysis
- metallographic analysis
- tensile test

AVAILABLE CERTIFICATES

- Technical product specifications
- Test report UNI EN10204 type 2.2
- Inspection certificate UNI EN10204 type 3.1
- CE Declaration of Conformity

Ø mm	≈ "	B x C mm	WLL kg	€	📦	🚚
5	3/16	21x10	70	1,30	250	080250005
6	1/4	25x12	100	1,76	250	080250006
8	5/16	33x16	250	2,96	150	080250008
10	3/8	42x20	400	3,25	180	080250010
11	7/16	46x22	500	4,00	130	080250011
12	1/2	50x24	600	4,30	100	080250012
14	9/16	57x28	800	5,55	70	080250014
16	5/8	61x32	1000	7,30	10	080250016
18	11/16	65x36	1300	10,60	10	080250018
20	3/4	70x40	1600	12,40	10	080250020
22	7/8	74x44	2000	17,10	10	080250022
25	1"	80x48	2800	23,00	2	080250025

special packaging

Ø mm	"	🔧	€	📦	🚚
5	3/16	25	32,50	1	080250705
6	1/4	25	44,00	1	080250706
8	5/16	25	74,00	1	080250708
10	3/8	15	48,50	1	080250710
11	7/16	12	48,00	1	080250711
12	1/2	12	51,50	1	080250712
14	9/16	10	55,50	1	080250714

special free service boxes



Ø mm	🔧	€	📦	🚚
5	4	6,55	1	080259205
6	4	8,40	1	080259206
8	2	7,00	1	080259208
10	2	7,50	1	080259210
11	1	4,95	1	080259011
12	1	5,40	1	080259012
14	1	6,55	1	080259014
16	1	8,30	1	080259016
18	1	12,40	1	080259018
20	1	13,90	1	080259020
22	1	18,20	1	080259022
25	1	23,90	1	080259025

8026A

lifting DEE shackles,
hot forged carbon steel,
UNI 1947 type A, galvanized

CE

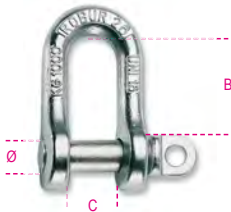

GRADO 4

TECHNICAL DATA

- safety factor: 5
 - heat treatment: normalizing
 - traceability code
- LABORATORY TESTS
- chemical analysis
 - metallographic analysis
 - tensile test

AVAILABLE CERTIFICATES

- Technical product specifications
- Test report UNI EN10204 type 2.2
- Inspection certificate UNI EN10204 type 3.1
- CE Declaration of Conformity

Ø mm	"	B x C mm	WLL kg	€	🔧	📦	🚚
12	1/2	42x20	630	4,10	35	080260012	
14	9/16	46x22	800	5,10	30	080260014	
16	5/8	50x24	1000	6,55	20	080260016	
18	11/16	54x26	1300	9,30	15	080260018	
20	3/4	58x28	1600	11,70	10	080260020	
22	7/8	69x32	2000	15,30	10	080260022	
25	1"	79x36	2500	21,80	5	080260025	
28	1.1/8	90x40	3150	30,00	2	080260028	
32	1.1/4	100x45	4000	41,00	1	080260032	
36	1.3/8	110x50	5000	59,00	1	080260036	
40	1.9/16	120x55	6300	81,50	1	080260040	
42	1.5/8	131x60	8000	111,50	1	080260042	
45	1.3/4	143x65	10000	152,00	1	080260045	
50	2"	155x70	12500	188,50	1	080260050	

special free service boxes



Ø mm	🔧	€	📦	🚚
12	1	5,30	1	080269012
14	1	6,35	1	080269014
16	1	7,40	1	080269016
18	1	11,20	1	080269018
20	1	13,40	1	080269020
22	1	17,10	1	080269022
25	1	23,90	1	080269025



8028

lifting BOW shackles,
hot forged carbon steel,
galvanized

CE

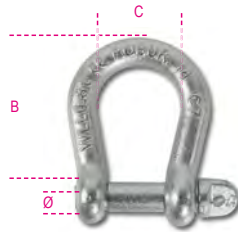

GRADO 4

TECHNICAL DATA

- safety factor: 5
 - heat treatment: normalizing
 - traceability code
- LABORATORY TESTS
- chemical analysis
 - metallographic analysis
 - tensile test

AVAILABLE CERTIFICATES

- Technical product specifications
- Test report UNI EN10204 type 2.2
- Inspection certificate UNI EN10204 type 3.1
- CE Declaration of Conformity

Ø mm	"	B x C mm	WLL kg	€	🔧	📦	🚚
5	3/16	20x16	80	1,12	100	080280105	
6	1/4	24x20	100	1,68	70	080280106	
8	5/16	32x24	200	2,89	35	080280108	
10	3/8	40x33	300	3,35	25	080280110	
12	1/2	48x39	500	5,30	15	080280112	
14	9/16	56x46	600	7,50	7	080280114	
16	5/8	64x46	800	11,30	10	080280116	
18	11/16	71x59	950	13,90	5	080280118	
20	3/4	80x65	1100	20,00	5	080280120	
22	7/8	88x72	1500	25,50	5	080280122	
25	1"	100x81	2000	38,50	2	080280125	
28	1.1/8	112x91	2600	59,50	1	080280128	
32	1.1/4	128x104	3200	82,00	1	080280132	
38	1.1/2	152x124	4500	163,00	1	080280138	

special free service boxes



Ø mm	🔧	€	📦	🚚
5	4	5,55	1	080289305
6	4	8,05	1	080289306
8	2	7,25	1	080289308
10	2	7,80	1	080289310
12	1	6,45	1	080289112
14	1	8,65	1	080289114
16	1	12,30	1	080289116
18	1	15,60	1	080289118
20	1	21,50	1	080289120
22	1	27,50	1	080289122

8049 WLL (t)

	A°	M8	M10	M12	M16	M20	M24	M30
	0°	0,3	0,6	1	1,6	2,5	4	6,3
	0°	0,6	1,2	2	3,2	5	8	12,6
	90°	0,3	0,6	1	1,6	2,5	4	6,3
	90°	0,6	1,2	2	3,2	5	8	12,6
	0° 45°	0,4	0,8	1,4	2,2	3,5	5,6	8,8
	46° 60°	0,3	0,6	1	1,6	2,5	4	6,3
	0° 45°	0,6	1,3	2,1	3,4	5,3	8,4	13,2
	46° 60°	0,3	0,6	1	1,6	2,3	4	6,3

8049

adjustable lifting eyebolts,
double swivel ring,
high-tensile alloy steel

CE

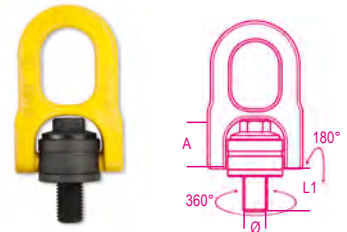

TECHNICAL DATA







- safety factor: 5
 - heat treatment: hardening and tempering
 - traceability code
- LABORATORY TESTS
- chemical analysis
 - metallographic analysis
 - tensile test

AVAILABLE CERTIFICATES

- Technical product specifications
- Test report UNI EN10204 type 2.2
- Inspection certificate UNI EN10204 type 3.1
- CE Declaration of Conformity

Ø mm	A mm	L1 mm	WLL kg	€	🔧	📦	🚚
M8	31,5	14	300	112,50	1	080490008	
M10	31,5	17	600	117,00	1	080490010	
M12	31,5	21	1000	120,50	1	080490012	
M16	45	27	1600	138,50	1	080490016	
M20	45	30	2500	142,00	1	080490020	
M24	60,5	36	4000	243,00	1	080490024	
M30	60,5	45	6300	253,00	1	080490030	



8049A WLL (t)								
	β (°)	M8	M10	M12	M16	M20	M24	M30
 WLL 1	0	600	900	1000	2000	4000	6300	10600
 WLL 2	0	1200	1800	2000	4000	8000	12600	21200
 WLL 3	90	300	450	500	1120	2000	3150	5300
 WLL 4	90	600	900	1000	2240	4000	6300	10600
 WLL 5	0-45	400	600	700	1400	2800	4250	7100
	45-60	300	400	500	1000	2000	3150	5300
 WLL 7	0-45	600	900	1000	2100	4200	6300	11200
	45-60	400	600	750	1500	3000	4750	8000

8049A

lifting eyebolts,
double swivel ring, turnable under load,
with welded ring,
high-tensile alloy steel

CE



TECHNICAL DATA



- safety factor: 4
- heat treatment: hardening
- traceability code

LABORATORY TESTS

- chemical analysis
- metallographic analysis
- tensile test
- fatigue test (20,000 cycles)
- testing load (100% of batch)

AVAILABLE CERTIFICATES

- Technical product specifications
- Test report UNI EN10204 type 2.2
- Inspection certificate UNI EN10204 type 3.1
- CE Declaration of Conformity

\emptyset mm	E mm	A mm	WLL kg	€		
M6	13	30	200	49,50	1	080490106
M8	13	30	300	50,50	1	080490108
M10	19	30	450	54,50	1	080490110
M12	19	30	500	58,00	1	080490112
M16	20	30	1120	62,50	1	080490116
M20	30	40	2000	81,50	1	080490120
M24	30	40	3150	118,00	1	080490124
M30	35	50	5300	190,50	1	080490130
M36	54	50	8000	203,50	1	080490136

 Robur



8049V

lifting eyebolts
with offset brackets,
high-tensile alloy steel
360° swivel eyebolt and swivel bracket

CE



TECHNICAL DATA



- safety factor: 4
- heat treatment: hardening and tempering
- traceability code

LABORATORY TESTS

- chemical analysis
- metallographic analysis
- tensile test
- fatigue test (20,000 cycles)
- test load (100% of batch)

AVAILABLE CERTIFICATES

- Technical product specifications
- Test report UNI EN10204 type 2.2
- Inspection certificate UNI EN10204 type 3.1
- CE Declaration of Conformity

\emptyset mm	E mm	B mm	WLL kg	€		
M12	18	37,5	1000	76,00	1	080490312
M16	24	37,5	1500	81,50	1	080490316
M20	35,5	54	2500	118,00	1	080490320
M24	35,5	54	4000	121,50	1	080490324

8041

lifting eyebolts,
high-tensile alloy steel

CE



TECHNICAL DATA



- safety factor: 4
- heat treatment: hardening and tempering
- traceability code

LABORATORY TESTS

- chemical analysis
- metallographic analysis
- tensile test
- fatigue test (20,000 cycles)
- proof load test (100% of batch)

AVAILABLE CERTIFICATES

- Technical product specifications
- Test report UNI EN10204 type 2.2
- Inspection certificate UNI EN10204 type 3.1
- CE Declaration of Conformity

\emptyset mm	$\frac{E}{\emptyset}$ mm	E mm	WLL kg	€		
M6	1	11	400	3,05	10	080410206
* M8	1,25	13	800	3,05	10	080410208
* M10	1,5	17	1000	4,65	6	080410210
* M12	1,75	20,5	1600	7,05	4	080410212
M14	2	20,5	3000	11,70	2	080410214
* M16	2	27	3200	11,70	2	080410216
M18	2,5	27	5000	17,60	2	080410218
* M20	2,5	30	4800	17,60	2	080410220
M22	2,5	30	7000	33,00	2	080410222
M24	3	41	8000	40,00	2	080410225
M27	3	41	10000	60,50	1	080410227
* M30	3,5	45	12000	60,50	1	080410230

(*) Dimensional specifications DIN 580:2010

WLL increased according to Robur Technical Product Specifications

special free service boxes

\emptyset mm		€		
* M8	1	4,85	1	080419208
* M10	1	6,80	1	080419210
* M12	1	9,40	1	080419212

 Robur

8043

lifting eye nuts,
high-tensile alloy steel

CE



TECHNICAL DATA

- safety factor: 4
- heat treatment: hardening and tempering
- traceability code

LABORATORY TESTS

- chemical analysis
- metallographic analysis
- tensile test
- fatigue test (20,000 cycles)
- proof load test (100% of batch)

AVAILABLE CERTIFICATES

- Technical product specifications
- Test report UNI EN10204 type 2.2
- Inspection certificate UNI EN10204 type 3.1
- CE Declaration of Conformity

M	Ø	F	WLL	€	kg	Art. No.
M6	1	20	400	2,96	10	080430206
* M8	1,25	20	800	2,96	10	080430208
* M10	1,50	25	1000	4,55	6	080430210
* M12	1,75	30	1600	6,95	4	080430212
M14	2	35	3000	11,40	2	080430214
* M16	2	35	3200	11,40	2	080430216
M18	2,5	40	5000	16,60	2	080430218
M20	2,5	50	6000	32,00	2	080430221
M22	2,5	50	7000	32,00	2	080430222
* M24	3	50	6500	32,00	2	080430224
M27	3	60	10000	58,00	1	080430227
* M30	3,5	60	12000	58,00	1	080430230

(*) Dimensional specifications DIN 582:2010
WLL increased according to Robur Technical Product Specifications

special free service boxes



Ø	kg	€	Art. No.
* M8	1	4,55	080439208
* M10	1	6,55	080439210
* M12	1	8,95	080439212

8040EZ

lifting eye bolts,
galvanized

CE



DIN 580:2010-09(**)

TECHNICAL DATA

- safety factor: 6
- heat treatment: normalizing
- traceability code

LABORATORY TESTS

- chemical analysis
- metallographic analysis
- tensile test

AVAILABLE CERTIFICATES

- Technical product specifications
- Test report UNI EN10204 type 2.2
- Inspection certificate UNI EN10204 type 3.1
- CE Declaration of Conformity

Ø	F	E	WLL	€	kg	Art. No.
* M6	1	11	90	1,65	60	080400406
M8	1,25	13	140	1,65	60	080400408
M10	1,5	17	230	2,21	40	080400410
M12	1,75	20,5	340	2,96	20	080400412
* M14	2	20,5	480	3,90	20	080400414
M16	2	27	700	4,85	10	080400416
* M18	2,5	27	930	5,90	10	080400418
M20	2,5	30	1200	7,50	10	080400420
* M22	2,5	30	1450	9,75	10	080400422
M24	3	36	1800	14,30	5	080400424
* M27	3	41	2400	17,60	5	080400427
M30	3,5	45	3200	29,50	2	080400430
* M33	3,5	54	3900	41,00	2	080400433
* M33F	2	54	3900	41,00	2	080400434
M36	4	54	4600	42,50	2	080400436
* M36F	3	54	4600	42,50	2	080400437
M42	4,5	63	6300	78,00	1	080400442
* M42F	3	63	6300	78,00	1	080400443
M48	5	68	8600	125,50	1	080400448
* M48F	3	68	8600	125,50	1	080400449
M56	5,5	78	11500	204,50	1	080400456
* M56F	4	78	11500	204,50	1	080400457
M64	6	90	16000	300,00	1	080400464
* M64F	4	90	16000	300,00	1	080400465

*Sizes dimensioned according to Robur Technical File

special free service boxes



Ø	kg	€	Art. No.
M6	4	8,20	080409606
M8	4	8,20	080409608
M10	2	6,10	080409610
M12	1	4,20	080409412
* M14	1	4,95	080409414
M16	1	6,10	080409416
* M18	1	7,20	080409418
M20	1	8,65	080409420
* M22	1	11,40	080409422
M24	1	15,40	080409424
* M27	1	19,30	080409427
M30	1	30,50	080409430

8040EN

lifting eye bolts,
self-coloured

CE

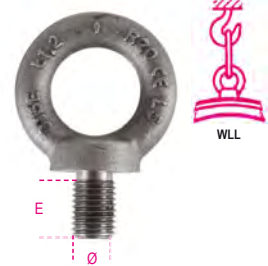

DIN 580:2010-09(**)

TECHNICAL DATA

- safety factor: 6
- heat treatment: normalizing
- traceability code

LABORATORY TESTS

- chemical analysis
- metallographic analysis
- tensile test

AVAILABLE CERTIFICATES

- Technical product specifications
- Test report UNI EN10204 type 2.2
- Inspection certificate UNI EN10204 type 3.1
- CE Declaration of Conformity

Ø	F	E	WLL	€	kg	Art. No.
* M6	1	11	90	1,58	60	080400306
M8	1,25	13	140	1,58	60	080400308
M10	1,5	17	230	2,15	40	080400310
M12	1,75	20,5	340	2,96	20	080400312
* M14	2	20,5	480	3,65	20	080400314
M16	2	27	700	4,55	10	080400316
* M18	2,5	27	930	5,70	10	080400318
M20	2,5	30	1200	7,05	10	080400320
* M22	2,5	30	1450	9,30	10	080400322
M24	3	36	1800	13,00	5	080400324
* M27	3	41	2400	16,50	5	080400327
M30	3,5	45	3200	27,50	2	080400330
* M33	3,5	54	3900	38,50	2	080400333
* M33F	2	54	3900	38,50	2	080400334
M36	4	54	4600	40,50	2	080400336
* M36F	3	54	4600	40,50	2	080400337
M42	4,5	63	6300	75,00	1	080400342
* M42F	3	63	6300	75,00	1	080400343
M48	5	68	8600	122,50	1	080400348
* M48F	3	68	8600	122,50	1	080400349
M56	5,5	78	11500	195,50	1	080400356
* M56F	4	78	11500	195,50	1	080400357
M64	6	90	16000	284,00	1	080400364
* M64F	4	90	16000	284,00	1	080400365

*Sizes dimensioned according to Robur Technical File

special free service boxes



Ø	kg	€	Art. No.
M6	4	7,70	080409506
M8	4	7,70	080409508
M10	2	5,60	080409510
M12	1	4,00	080409312
* M14	1	4,75	080409314
M16	1	5,60	080409316
* M18	1	6,70	080409318
M20	1	7,80	080409320
* M22	1	10,70	080409322
M24	1	14,30	080409324
* M27	1	17,60	080409327
M30	1	28,50	080409330

8042EN

lifting eye nuts,
self-coloured

CE



DIN582:2010-09(**)

TECHNICAL DATA

- safety factor: 6
- heat treatment: normalizing
- traceability code

LABORATORY TESTS

- chemical analysis
- metallographic analysis
- tensile test

AVAILABLE CERTIFICATES

- Technical product specifications
- Test report UNI EN10204 type 2.2
- Inspection certificate UNI EN10204 type 3.1
- CE Declaration of Conformity

Ø mm	F mm	WLL kg	€	📦	🚚
* M6	14	90	1,58	60	080420306
M8	20	140	1,58	60	080420308
M10	25	230	2,10	40	080420310
M12	30	340	2,96	30	080420312
* M14	30	480	3,75	30	080420314
M16	35	700	4,45	20	080420316
* M18	35	930	5,60	20	080420318
M20	40	1200	6,80	10	080420320
* M22	40	1450	9,10	10	080420322
M24	50	1800	13,00	5	080420324
* M27	55	2400	15,80	5	080420327
M30	60	3200	25,50	3	080420330
M36	70	4600	38,50	2	080420336
* M36F	70	4600	38,50	2	080420337
M42	80	6300	71,50	1	080420342
* M42F	80	6300	71,50	1	080420343
M48	90	8600	117,00	1	080420348
* M48F	90	8600	117,00	1	080420349

*Sizes dimensioned according to Robur Technical File

special free service boxes



Ø mm	📦	€	🚚	
M6	4	7,70	1	080429506
M8	4	7,70	1	080429508
M10	2	5,60	1	080429510
M12	1	3,90	1	080429312
* M14	1	4,55	1	080429314
M16	1	5,60	1	080429316
* M18	1	6,55	1	080429318
M20	1	7,90	1	080429320
* M22	1	10,30	1	080429322
M24	1	14,80	1	080429324
* M27	1	17,60	1	080429327
M30	1	26,50	1	080429330

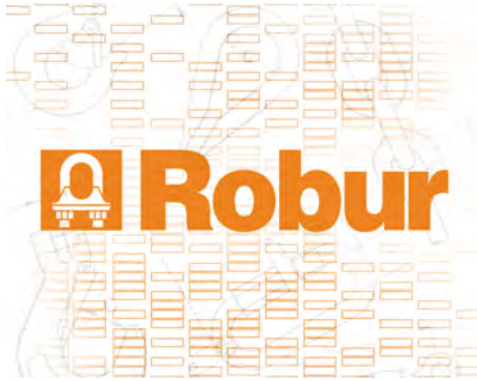

8042EZ

lifting eye nuts,
galvanized

CE



DIN582:2010-09(**)

TECHNICAL DATA

- safety factor: 6
- heat treatment: normalizing
- traceability code

LABORATORY TESTS

- chemical analysis
- metallographic analysis
- tensile test

AVAILABLE CERTIFICATES

- Technical product specifications
- Test report UNI EN10204 type 2.2
- Inspection certificate UNI EN10204 type 3.1
- CE Declaration of Conformity

Ø mm	F mm	WLL kg	€	📦	🚚
* M6	14	90	1,65	60	080420406
M8	20	140	1,65	60	080420408
M10	25	230	2,21	40	080420410
M12	30	340	3,05	30	080420412
* M14	30	480	3,90	30	080420414
M16	35	700	4,85	20	080420416
* M18	35	930	5,90	20	080420418
M20	40	1200	7,40	10	080420420
* M22	40	1450	9,65	10	080420422
M24	50	1800	14,30	5	080420424
* M27	55	2400	17,10	5	080420427
M30	60	3200	27,50	3	080420430
M36	70	4600	42,00	2	080420436
* M36F	70	4600	42,00	2	080420437
M42	80	6300	76,00	1	080420442
* M42F	80	6300	76,00	1	080420443
M48	90	8600	123,50	1	080420448
* M48F	90	8600	123,50	1	080420449

*Sizes dimensioned according to Robur Technical File

special free service boxes



Ø mm	📦	€	🚚	
M6	4	7,90	1	080429606
M8	4	7,90	1	080429608
M10	2	5,70	1	080429610
M12	1	4,20	1	080429412
* M14	1	4,75	1	080429414
M16	1	5,90	1	080429416
* M18	1	6,80	1	080429418
M20	1	8,40	1	080429420
* M22	1	10,70	1	080429422
M24	1	16,50	1	080429424
* M27	1	18,20	1	080429427
M30	1	28,00	1	080429430

8044

lifting eye nuts, UNI 2948
self-coloured

CE



UNI 2948

TECHNICAL DATA

- safety factor: 4
- heat treatment: normalizing
- traceability code

LABORATORY TESTS

- chemical analysis
- metallographic analysis
- tensile test

AVAILABLE CERTIFICATES

- Technical product specifications
- Test report UNI EN10204 type 2.2
- Inspection certificate UNI EN10204 type 3.1
- CE Declaration of Conformity

Ø mm	F mm	WLL kg	€	📦	🚚
M8	1,25	80	2,10	4	080440008
M10	1,5	160	3,45	4	080440010
M12	1,75	250	6,00	4	080440012
M14	2	250	9,75	2	080440014
M16	2	400	9,85	2	080440016
M20	2,5	630	16,50	2	080440020
M24	3	1000	28,50	2	080440024



CHAIN SLINGS Grade 8

Ø D mm	WLL Ton		UNI EN 818
	0° < β ≤ 45°	45° < β ≤ 60°	
6	1,12	1,6	1,12
7	1,5	2,12	1,5
8	2	2,8	2
10	3,15	4,25	3,15
13	5,3	7,5	5,3
16	8	11,2	8

Ø D mm	WLL Ton	
	0° < β ≤ 45°	45° < β ≤ 60°
6	2,36	1,7
7	3,15	2,24
8	4,25	3
10	6,7	4,75
13	11,2	8
16	17	11,2

8091
lifting chain slings, 1 leg
grade 8

CE

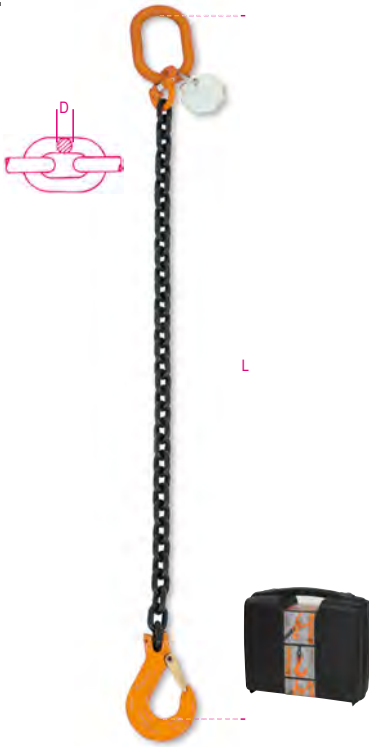

UNI EN 818-4

TECHNICAL DATA

- safety factor: 4
 - chain-sling identification tag
- ATTACHED CERTIFICATES**
- Manufacturer's Certificate UNI EN818-4
 - CE Declaration of Conformity
- AVAILABLE CERTIFICATES**
- Technical product specifications

D mm	L m	WLL ton	€		
6*	1	1,12	81,50	1	080910001
6*	2	1,12	100,00	1	080910002
6*	3	1,12	118,00	1	080910003
6*	4	1,12	136,00	1	080910004
7*	1	1,5	89,50	1	080910021
7*	2	1,5	112,50	1	080910022
7*	3	1,5	136,00	1	080910023
7*	4	1,5	159,00	1	080910024
8*	1	2	99,50	1	080910041
8*	2	2	127,00	1	080910042
8*	3	2	154,50	1	080910043
8*	4	2	194,50	1	080910044
10*	1	3,15	127,00	1	080910051
10*	2	3,15	168,00	1	080910052
10*	3	3,15	221,50	1	080910053
10*	4	3,15	263,00	1	080910054
13*	1	5,3	204,50	1	080910131
13*	2	5,3	275,00	1	080910132
13*	3	5,3	342,00	1	080910133
13*	4	5,3	412,00	1	080910134
16*	1	8	401,00	1	080910161
16*	2	8	505,00	1	080910162
16*	3	8	611,00	1	080910163
16*	4	8	718,00	1	080910164

* packed in plastic case



8091SL

lifting chain slings,
1 leg, self-locking hook,
grade 8

CE

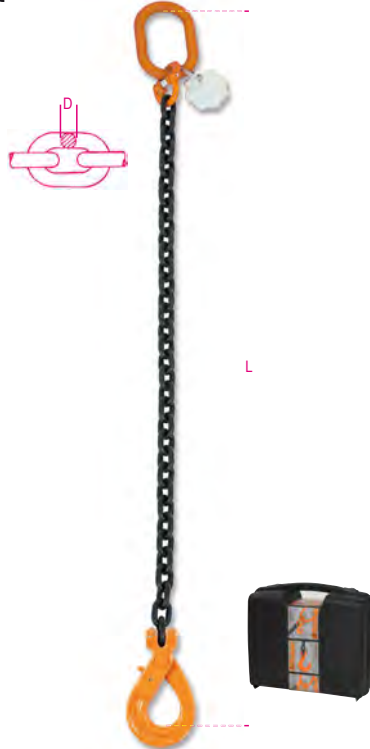

UNI EN 818-4

TECHNICAL DATA

- safety factor: 4
 - chain-sling identification tag
- ATTACHED CERTIFICATES**
- Manufacturer's Certificate UNI EN818-4
 - CE Declaration of Conformity
- AVAILABLE CERTIFICATES**
- Technical product specifications

D mm	L m	WLL ton	€		
6*	1	1,12	103,00	1	080910201
6*	2	1,12	121,00	1	080910202
6*	3	1,12	139,50	1	080910203
6*	4	1,12	157,50	1	080910204
7*	1	1,5	117,50	1	080910221
7*	2	1,5	140,50	1	080910222
7*	3	1,5	164,00	1	080910223
7*	4	1,5	187,50	1	080910224
8*	1	2	128,00	1	080910241
8*	2	2	150,00	1	080910242
8*	3	2	183,00	1	080910243
8*	4	2	222,50	1	080910244
10*	1	3,15	160,00	1	080910251
10*	2	3,15	201,00	1	080910252
10*	3	3,15	255,00	1	080910253
10*	4	3,15	308,00	1	080910254
13*	1	5,3	281,00	1	080910331
13*	2	5,3	372,00	1	080910332
13*	3	5,3	421,00	1	080910333
13*	4	5,3	509,00	1	080910334
16*	1	8	529,00	1	080910361
16*	2	8	664,00	1	080910362
16*	3	8	739,00	1	080910363
16*	4	8	877,00	1	080910364

* Packed in plastic case

8092
lifting chains sling, 2 legs
grade 8

CE



UNI EN 818-4

TECHNICAL DATA

- safety factor: 4
 - chain-sling identification tag
- ATTACHED CERTIFICATES**
- Manufacturer's Certificate UNI EN818-4
 - CE Declaration of Conformity
- AVAILABLE CERTIFICATES**
- Technical product specifications

D mm	L m	WLL ton	€		
6*	1	1,6	119,50	1	080920001
6*	2	1,6	156,00	1	080920002
6*	3	1,6	192,50	1	080920003
6*	4	1,6	241,00	1	080920004
7*	1	2,12	139,00	1	080920021
7*	2	2,12	185,50	1	080920022
7*	3	2,12	244,50	1	080920023
7*	4	2,12	291,00	1	080920024
8*	1	2,8	157,00	1	080920041
8*	2	2,8	212,00	1	080920042
8*	3	2,8	280,00	1	080920043
8*	4	2,8	335,00	1	080920044
10*	1	4,25	228,00	1	080920051
10*	2	4,25	310,00	1	080920052
10*	3	4,25	389,00	1	080920053
10*	4	4,25	471,00	1	080920054
13*	1	7,5	363,00	1	080920131
13*	2	7,5	500,00	1	080920132
13	3	7,5	621,00	1	080920133
13	4	7,5	809,00	1	080920134
16*	1	11,2	728,00	1	080920161
16	2	11,2	969,00	1	080920162
16	3	11,2	1.182,00	1	080920163
16	4	11,2	1.395,00	1	080920164

* packed in plastic case



Robur

8092SL

lifting chain slings,
2 legs, self-locking hook,
grade 8

CE



UNI EN 818-4

TECHNICAL DATA

- safety factor: 4
- chain-sling identification tag
- ATTACHED CERTIFICATES
- Manufacturer's Certificate UNI EN818-4
- CE Declaration of Conformity
- AVAILABLE CERTIFICATES
- Technical product specifications

D mm	L m	WLL ton	€	📄	📦
6*	1	1,6	162,50	1	080920201
6*	2	1,6	191,50	1	080920202
6*	3	1,6	228,00	1	080920203
6*	4	1,6	284,00	1	080920204
7*	1	2,12	195,50	1	080920221
7*	2	2,12	232,50	1	080920222
7*	3	2,12	301,00	1	080920223
7*	4	2,12	347,00	1	080920224
8*	1	2,8	203,00	1	080920241
8*	2	2,8	270,00	1	080920242
8*	3	2,8	325,00	1	080920243
8*	4	2,8	391,00	1	080920244
10*	1	4,25	319,00	1	080920251
10*	2	4,25	376,00	1	080920252
10*	3	4,25	455,00	1	080920253
10*	4	4,25	562,00	1	080920254
13*	1	7,5	558,00	1	080920331
13*	2	7,5	658,00	1	080920332
13*	3	7,5	816,00	1	080920333
13*	4	7,5	1.004,00	1	080920334
16*	1	11,2	1.047,00	1	080920361
16*	2	11,2	1.290,00	1	080920362
16*	3	11,2	1.500,00	1	080920363
16*	4	11,2	1.715,00	1	080920364

* Packed in plastic case

Robur

8094

lifting chain sling, 4 legs
grade 8

CE



UNI EN 818-4

TECHNICAL DATA

- safety factor: 4
- chain-sling identification tag
- ATTACHED CERTIFICATES
- Manufacturer's Certificate UNI EN818-4
- CE Declaration of Conformity
- AVAILABLE CERTIFICATES
- Technical product specifications

D mm	L m	WLL ton	€	📄	📦
6*	1	2,36	248,50	1	080940001
6*	2	2,36	334,00	1	080940002
6*	3	2,36	407,00	1	080940003
6*	4	2,36	477,00	1	080940004
7*	1	3,15	292,00	1	080940021
7*	2	3,15	385,00	1	080940022
7*	3	3,15	475,00	1	080940023
7*	4	3,15	569,00	1	080940024
8*	1	4,25	350,00	1	080940041
8*	2	4,25	457,00	1	080940042
8*	3	4,25	567,00	1	080940043
8	4	4,25	706,00	1	080940044
10*	1	6,7	463,00	1	080940051
10	2	6,7	639,00	1	080940052
10	3	6,7	820,00	1	080940053
10	4	6,7	984,00	1	080940054
13	1	11,2	771,00	1	080940131
13	2	11,2	1.051,00	1	080940132
13	3	11,2	1.330,00	1	080940133
13	4	11,2	1.610,00	1	080940134
16	1	17	1.515,00	1	080940161
16	2	17	1.940,00	1	080940162
16	3	17	2.365,00	1	080940163
16	4	17	2.790,00	1	080940164

* packed in plastic case

8094SL

lifting chain slings,
4 legs, self-locking hook,
grade 8

CE



UNI EN 818-4

TECHNICAL DATA

- safety factor: 4
- chain-sling identification tag
- ATTACHED CERTIFICATES
- Manufacturer's Certificate UNI EN818-4
- CE Declaration of Conformity
- AVAILABLE CERTIFICATES
- Technical product specifications

D mm	L m	WLL ton	€	📄	📦
6*	1	2,36	334,00	1	080940201
6*	2	2,36	419,00	1	080940202
6*	3	2,36	492,00	1	080940203
6*	4	2,36	562,00	1	080940204
7*	1	3,15	404,00	1	080940221
7*	2	3,15	498,00	1	080940222
7*	3	3,15	588,00	1	080940223
7*	4	3,15	681,00	1	080940224
8*	1	4,25	442,00	1	080940241
8*	2	4,25	549,00	1	080940242
8*	3	4,25	681,00	1	080940243
8	4	4,25	820,00	1	080940244
10*	1	6,7	603,00	1	080940251
10	2	6,7	771,00	1	080940252
10	3	6,7	960,00	1	080940253
10	4	6,7	1.124,00	1	080940254
13	1	11,2	1.091,00	1	080940331
13	2	11,2	1.370,00	1	080940332
13	3	11,2	1.650,00	1	080940333
13	4	11,2	1.930,00	1	080940334
16	1	17	2.045,00	1	080940361
16	2	17	2.470,00	1	080940362
16	3	17	2.900,00	1	080940363
16	4	17	3.320,00	1	080940364

* Packed in plastic case

Robur

8096

lifting chain sling, 1 leg
with clevis grab hook,
grade 8

CE



UNI EN 818-4

TECHNICAL DATA

- safety factor: 4
- chain-sling identification tag
- ATTACHED CERTIFICATES
- Manufacturer's Certificate UNI EN818-4
- CE Declaration of Conformity
- AVAILABLE CERTIFICATES
- Technical product specifications

D mm	L m	WLL ton	€	U	U
6*	1	1,12	96,50	1	080960001
6*	2	1,12	115,00	1	080960002
6*	3	1,12	133,00	1	080960003
6*	4	1,12	147,50	1	080960004
7*	1	1,5	107,00	1	080960021
7*	2	1,5	130,00	1	080960022
7*	3	1,5	149,00	1	080960023
7*	4	1,5	172,00	1	080960024
8*	1	2	118,00	1	080960041
8*	2	2	145,50	1	080960042
8*	3	2	173,00	1	080960043
8*	4	2	213,00	1	080960044
10*	1	3,15	163,50	1	080960051
10*	2	3,15	216,50	1	080960052
10*	3	3,15	258,00	1	080960053
10*	4	3,15	299,00	1	080960054
13*	1	5,3	268,00	1	080960131
13*	2	5,3	317,00	1	080960132
13*	3	5,3	384,00	1	080960133
13*	4	5,3	475,00	1	080960134
16*	1	8	527,00	1	080960161
16*	2	8	599,00	1	080960162
16*	3	8	705,00	1	080960163
16	4	8	840,00	1	080960164

* packed in plastic case

8096SL

lifting chain slings,
1 leg, with self-locking and clevis grab hooks,
grade 8

CE



UNI EN 818-4

TECHNICAL DATA

- safety factor: 4
- chain-sling identification tag
- ATTACHED CERTIFICATES
- Manufacturer's Certificate UNI EN818-4
- CE Declaration of Conformity
- AVAILABLE CERTIFICATES
- Technical product specifications

D mm	L m	WLL ton	€	U	U
6*	1	1,12	114,50	1	080960201
6*	2	1,12	132,50	1	080960202
6*	3	1,12	150,50	1	080960203
6*	4	1,12	169,00	1	080960204
7*	1	1,5	130,50	1	080960221
7*	2	1,5	153,50	1	080960222
7*	3	1,5	177,00	1	080960223
7*	4	1,5	200,50	1	080960224
8*	1	2	141,00	1	080960241
8*	2	2	168,50	1	080960242
8*	3	2	196,00	1	080960243
8*	4	2	235,50	1	080960244
10*	1	3,15	196,50	1	080960251
10*	2	3,15	249,50	1	080960252
10*	3	3,15	291,00	1	080960253
10*	4	3,15	332,00	1	080960254
13*	1	5,3	344,00	1	080960331
13*	2	5,3	414,00	1	080960332
13*	3	5,3	481,00	1	080960333
13*	4	5,3	551,00	1	080960334
16*	1	8	655,00	1	080960361
16*	2	8	758,00	1	080960362
16*	3	8	865,00	1	080960363
16	4	8	968,00	1	080960364

* Packed in plastic case

8097

lifting chain sling, 2 legs
with clevis grab hooks,
grade 8

CE



UNI EN 818-4

TECHNICAL DATA

- safety factor: 4
- chain-sling identification tag
- ATTACHED CERTIFICATES
- Manufacturer's Certificate UNI EN818-4
- CE Declaration of Conformity
- AVAILABLE CERTIFICATES

• Technical product specifications

D mm	L m	WLL ton	€	U	U
6*	1	1,6	149,50	1	080970001
6*	2	1,6	179,00	1	080970002
6*	3	1,6	222,50	1	080970003
6*	4	1,6	264,00	1	080970004
7*	1	2,12	174,50	1	080970021
7*	2	2,12	224,00	1	080970022
7*	3	2,12	271,00	1	080970023
7*	4	2,12	317,00	1	080970024
8*	1	2,8	194,00	1	080970041
8*	2	2,8	251,00	1	080970042
8*	3	2,8	317,00	1	080970043
8*	4	2,8	372,00	1	080970044
10*	1	4,25	301,00	1	080970051
10*	2	4,25	383,00	1	080970052
10*	3	4,25	462,00	1	080970053
10*	4	4,25	544,00	1	080970054
13*	1	7,5	486,00	1	080970131
13*	2	7,5	626,00	1	080970132
13	3	7,5	753,00	1	080970133
13	4	7,5	893,00	1	080970134
16	1	11,2	944,00	1	080970161
16	2	11,2	1.157,00	1	080970162
16	3	11,2	1.370,00	1	080970163
16	4	11,2	1.585,00	1	080970164

* packed in plastic case



8097SL

lifting chain slings,
2 legs, with self-locking and clevis grab hooks,
grade 8

CE



UNI EN 818-4

TECHNICAL DATA

- safety factor: 4
- chain-sling identification tag
- ATTACHED CERTIFICATES
- Manufacturer's Certificate UNI EN818-4
- CE Declaration of Conformity
- AVAILABLE CERTIFICATES
- Technical product specifications

D mm	L m	WLL ton	€	📦	📄
6*	1	1,6	185,00	1	080970201
6*	2	1,6	214,00	1	080970202
6*	3	1,6	258,00	1	080970203
6*	4	1,6	307,00	1	080970204
7*	1	2,12	221,50	1	080970221
7*	2	2,12	271,00	1	080970222
7*	3	2,12	318,00	1	080970223
7*	4	2,12	364,00	1	080970224
8*	1	2,8	240,00	1	080970241
8*	2	2,8	296,00	1	080970242
8*	3	2,8	362,00	1	080970243
8*	4	2,8	417,00	1	080970244
10*	1	4,25	367,00	1	080970251
10*	2	4,25	449,00	1	080970252
10*	3	4,25	528,00	1	080970253
10*	4	4,25	610,00	1	080970254
13*	1	7,5	639,00	1	080970331
13*	2	7,5	779,00	1	080970332
13	3	7,5	948,00	1	080970333
13	4	7,5	1.046,00	1	080970334
16	1	11,2	1.265,00	1	080970361
16	2	11,2	1.475,00	1	080970362
16	3	11,2	1.690,00	1	080970363
16	4	11,2	1.840,00	1	080970364

* Packed in plastic case



8098

lifting chain sling, 4 legs
with clevis grab hooks,
grade 8

CE



UNI EN 818-4

TECHNICAL DATA

- safety factor: 4
- chain-sling identification tag
- ATTACHED CERTIFICATES
- Manufacturer's Certificate UNI EN818-4
- CE Declaration of Conformity
- AVAILABLE CERTIFICATES
- Technical product specifications

D mm	L m	WLL ton	€	📦	📄
6*	1	2,36	309,00	1	080980001
6*	2	2,36	379,00	1	080980002
6*	3	2,36	449,00	1	080980003
6*	4	2,36	522,00	1	080980004
7*	1	3,15	362,00	1	080980021
7*	2	3,15	437,00	1	080980022
7*	3	3,15	527,00	1	080980023
7*	4	3,15	621,00	1	080980024
8*	1	4,25	402,00	1	080980041
8*	2	4,25	509,00	1	080980042
8*	3	4,25	619,00	1	080980043
8	4	4,25	758,00	1	080980044
10*	1	6,7	559,00	1	080980051
10	2	6,7	751,00	1	080980052
10	3	6,7	915,00	1	080980053
10	4	6,7	1.079,00	1	080980054
13	1	11,2	939,00	1	080980131
13	2	11,2	1.220,00	1	080980132
13	3	11,2	1.510,00	1	080980133
13	4	11,2	1.780,00	1	080980134
16	1	17	1.890,00	1	080980161
16	2	17	2.315,00	1	080980162
16	3	17	2.740,00	1	080980163
16	4	17	3.170,00	1	080980164

* packed in plastic case

8098SL

lifting chain slings,
4 legs, with self-locking and clevis grab hooks,
grade 8

CE



UNI EN 818-4

TECHNICAL DATA

- safety factor: 4
- chain-sling identification tag
- ATTACHED CERTIFICATES
- Manufacturer's Certificate UNI EN818-4
- CE Declaration of Conformity
- AVAILABLE CERTIFICATES
- Technical product specifications

D mm	L m	WLL ton	€	📦	📄
6*	1	2,36	380,00	1	080980201
6*	2	2,36	465,00	1	080980202
6*	3	2,36	520,00	1	080980203
6*	4	2,36	608,00	1	080980204
7*	1	3,15	456,00	1	080980221
7*	2	3,15	531,00	1	080980222
7*	3	3,15	621,00	1	080980223
7*	4	3,15	715,00	1	080980224
8*	1	4,25	516,00	1	080980241
8*	2	4,25	601,00	1	080980242
8	3	4,25	711,00	1	080980243
8*	4	4,25	850,00	1	080980244
10*	1	6,7	691,00	1	080980251
10	2	6,7	883,00	1	080980252
10	3	6,7	1.047,00	1	080980253
10	4	6,7	1.210,00	1	080980254
13	1	11,2	1.245,00	1	080980331
13	2	11,2	1.525,00	1	080980332
13	3	11,2	1.820,00	1	080980333
13	4	11,2	2.085,00	1	080980334
16	1	17	2.420,00	1	080980361
16	2	17	2.850,00	1	080980362
16	3	17	3.270,00	1	080980363
16	4	17	3.680,00	1	080980364

* Packed in plastic case



8085R

lifting master links,
high-tensile alloy steel

WLL relates to use with 1 chain slings.

CE



EN 1677-4
GRADO 8

TECHNICAL DATA

- safety factor: 4
- heat treatment: hardening and tempering
- traceability code

LABORATORY TESTS

- chemical analysis, metallographic analysis
- proof load test (WLL x 2.5)
- tensile test
- fatigue test (min. 20,000 cycles)

AVAILABLE CERTIFICATES

- Technical product specifications
- Test report UNI EN10204 type 2.2
- Inspection certificate UNI EN10204 type 3.1
- CE Declaration of Conformity

WLL	Ø mm	A	€	Icon	Icon
kg	mm	mm			
8085R 1600	7	110	9,65	1	080850215
8085R 2120	8	110	13,60	1	080850220
8085R 3150	10	135	19,30	1	080850232
8085R 5300	13	160	34,00	1	080850253

8085 8,0	8000	16	180	67,50	1	080850080
8085 11,2	11200	19	200	110,00	1	080850190

* If you match it with a chain 6mm in Ø, WLL= 1120 kg

8086

lifting master link assemblies
alloy steel, painted

* WLL means the use with 3 or 4 chain slings
and B angle < 45°.

CE



EN 1677-4

TECHNICAL DATA

- safety factor: 4
- heat treatment: hardening and tempering
- traceability code

LABORATORY TESTS

- chemical analysis, metallographic analysis
- proof load test (WLL x 2.5)
- tensile test
- fatigue test (min. 20,000 cycles)

AVAILABLE CERTIFICATES

- Technical product specifications
- Test report UNI EN10204 type 2.2
- Inspection certificate UNI EN10204 type 3.1
- CE Declaration of Conformity

WLL	Ø mm	B	C	€	Icon	Icon
kg	mm	mm	mm			
* 3150	7	135	75	62,50	1	080860021
4250	8	160	90	96,00	1	080860042
6700	10	180	100	123,50	1	080860067
11200	13	200	110	200,50	1	080860100
17000	16	260	140	293,00	1	080860117

*If you match it with a chain 6 mm in Ø, WLL=2360 Kg.

8090R

lifting connecting links
alloy steel, painted

CE

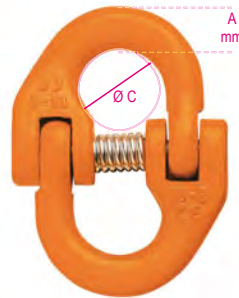

EN 1677-1

TECHNICAL DATA

- safety factor: 4
- heat treatment: hardening and tempering
- traceability code

LABORATORY TESTS

- chemical analysis, metallographic analysis
- proof load test (WLL x 2.5)
- tensile test
- fatigue test (min. 20,000 cycles)

AVAILABLE CERTIFICATES

- Technical product specifications
- Test report UNI EN10204 type 2.2
- Inspection certificate UNI EN10204 type 3.1
- CE Declaration of Conformity

WLL	Ø mm	Ø C	A	€	Icon	Icon
kg	mm	mm	mm			
8090R 6	1120	13	7,5	8,20	1	080900111
8090R 7	1500	18	9	10,60	1	080900115
8090R 8	2000	18	11	12,90	1	080900120
8090R 10	3150	22	13,0	15,80	1	080900131
8090R 13	5300	30	16	28,50	1	080900153

8090	16	8000	32	62,50	1	080900080
------	----	------	----	-------	---	-----------

8060R

Clevis chain hooks,
high-tensile alloy steel

CE



EN 1677-2

TECHNICAL DATA

- safety coefficient: 4
- heat treatment: hardening and tempering
- Traceability code on pin, safety latch, body

LABORATORY TESTS

- chemical analysis, metallographic analysis
- proof load test (WLL x 2.5)
- tensile test
- fatigue test (min. 20,000 cycles)

AVAILABLE CERTIFICATES

- Technical Product Specifications
- Test Report UNI EN10204 type 2.2
- Inspection Certificate UNI EN10204 type 3.1
- CE Declaration of Conformity

WLL	Ø mm	C	€	Icon	Icon
kg	mm	mm			
8060R 1120	6	19	15,30	1	080600111
8060R 1500	7	19	16,50	1	080600115
8060R 2000	8	21	17,10	1	080600120
8060R 3150	10	27	29,50	1	080600132
8060R 5300	13	35	47,00	1	080600153

8060	8000	16	48	150,00	1	080600080
------	------	----	----	--------	---	-----------

8058R

self-locking lifting hooks,
Clevis type,
high-tensile alloy steel

CE



EN 1677-3

TECHNICAL DATA

- safety factor: 4
- heat treatment: hardening and tempering
- traceability code

LABORATORY TESTS

- chemical analysis, metallographic analysis
- tensile test
- fatigue test (min. 20,000 cycles)
- proof load test (100% of batch)

AVAILABLE CERTIFICATES

- Technical product specifications
- Test report UNI EN10204 type 2.2
- Inspection certificate UNI EN10204 type 3.1
- CE Declaration of Conformity

WLL	Ø mm	J min	€	Icon	Icon
kg	mm	mm			
8058R 1120	6	28	33,00	1	080580112
8058R 2000	7-8	34	40,00	1	080580120
8058R 3150	10	44	62,50	1	080580132
8058R 5300	13	52	123,50	1	080580153

8058	8000	16	67	278,00	1	080580080
------	------	----	----	--------	---	-----------

8061R

Clevis grab hooks
with safety latch,
high-tensile alloy steel

CE



EN 1677-1

TECHNICAL DATA

- safety factor: 4
- heat treatment: hardening and tempering
- traceability code

LABORATORY TESTS

- chemical analysis, metallographic analysis
- tensile test
- fatigue test (min. 20,000 cycles)
- proof load test (100% of batch)

AVAILABLE CERTIFICATES

- Technical product specifications
- Test report UNI EN10204 type 2.2
- Inspection certificate UNI EN10204 type 3.1
- CE Declaration of Conformity

WLL	Ø mm	E	€	Icon	Icon
kg	mm	mm			
8061R 1120	6	8	11,40	1	080610211
8061R 2000	7-8	11	13,00	1	080610220
8061R 3150	10	13	23,90	1	080610231
8061R 5300	13	17	42,00	1	080610253

8061F	8000	16	20	94,00	1	080610180
-------	------	----	----	-------	---	-----------

8052

wire rope eye hooks,
high-tensile alloy steel

CE



EN 1677-2

TECHNICAL DATA

- safety factor: 4
 - heat treatment: hardening and tempering
 - traceability code
- LABORATORY TESTS
- chemical analysis, metallographic analysis
 - tensile test

- fatigue test (min. 20,000 cycles)
- proof load test (2 x WLL)

AVAILABLE CERTIFICATES

- Technical Product Specifications
- Test Report UNI EN10204 type 2.2
- Inspection Certificate UNI EN10204 type 3.1
- CE Declaration of Conformity

	WLL		C	€	📄	📄
	kg	mm				
8052	800	18		5,85	1	080520008
8052	1120	22,5		7,80	1	080520011
8052	2000	30		16,60	1	080520020
8052	3150	36		25,50	1	080520031
8052	4000	39,5		33,00	1	080520040

8055S	5400	32		64,00	1	080550145
8055S	8000	43		111,50	1	080550170
8055S	11500	53		222,00	1	080550215
8055S	16000	58		298,00	1	080550260
8055S	22000	78		699,00	1	080550320

8057R

self-locking lifting hooks,
eye type,
high-tensile alloy steel

CE



EN 1677-3

TECHNICAL DATA

- safety factor: 4
 - heat treatment: hardening and tempering
 - traceability code
- LABORATORY TESTS
- chemical analysis, metallographic analysis
 - tensile test

- fatigue test (min. 20,000 cycles)
- proof load test (100% of batch)

AVAILABLE CERTIFICATES

- Technical product specifications
- Test report UNI EN10204 type 2.2
- Inspection certificate UNI EN10204 type 3.1
- CE Declaration of Conformity

	WLL		J min	ØB	€	📄	📄
	kg	mm					
8057R	1120	6	28	22	26,50	1	080570112
8057R	2000	7-8	34	25	31,50	1	080570120
8057R	3150	10	44	32	56,50	1	080570132

8057	5300	13	54	40	198,50	1	080570053
------	------	----	----	----	--------	---	-----------

8063

lifting swivel hooks
(in unloaded condition)
high-tensile alloy steel

CE



EN 1677-1

TECHNICAL DATA

- safety factor: 4
 - heat treatment: hardening and tempering
 - traceability code
- LABORATORY TESTS
- chemical analysis, metallographic analysis
 - tensile test

- fatigue test (min. 20,000 cycles)
- proof load test (100% of batch)

AVAILABLE CERTIFICATES

- Technical Product Specifications
- Test report UNI EN10204 type 2.2
- Inspection certificate UNI EN10204 type 3.1
- CE Declaration of Conformity

WLL	A	E	€	📄	📄
800	32	20,5	13,00	1	080630008
1120	38	20,5	16,50	1	080630011
2000	44,5	22	20,00	1	080630020
3150	44,5	27	24,90	1	080630031

8063SL

self-locking swivel hooks
(not under load)
high-tensile alloy steel
grade 8

CE



EN 1677-1

TECHNICAL DATA

- safety factor: 4
 - heat treatment: hardening and tempering
 - traceability code
- LABORATORY TESTS
- chemical analysis, metallographic analysis
 - tensile test

- fatigue test (min. 20,000 cycles)
- load test (100% of batch)

AVAILABLE CERTIFICATES

- Technical product specifications
- Test report UNI EN10204 type 2.2
- Inspection certificate UNI EN10204 type 3.1
- CE Declaration of Conformity

WLL	A	B	J	€	📄	📄
1120	148	32	45	34,50	1	080630311
2000	182	35	59	47,50	1	080630320
3150	218	42	54	83,00	1	080630331
5300	269	49	83	126,00	1	080630353

8064S

swivel lifting hooks
(not under load)
carbon steel, painted

CE



EN 1677-5

TECHNICAL DATA

- safety factor: 5
 - heat treatment: hardening and tempering
 - traceability code
- LABORATORY TESTS
- chemical analysis, metallographic analysis
 - proof load test (WLL x 2.5)
 - tensile test

- fatigue test (min. 20,000 cycles)

AVAILABLE CERTIFICATES

- Technical product specifications
- Test report UNI EN10204 type 2.2
- Inspection certificate UNI EN10204 type 3.1
- CE Declaration of Conformity

WLL	B	C	€	📄	📄
800	31	20	32,00	1	080640107
1000	40	22	45,00	1	080640110
1600	47	23	59,00	1	080640115
2000	47	27	64,50	1	080640120
3200	64	35	112,50	1	080640130
5000	77	43	205,50	1	080640150
7500	90	53	299,00	1	080640175
10000	96	58	497,00	1	080640199

8065SC

swivel load lifting hooks
carbon steel, painted

CE

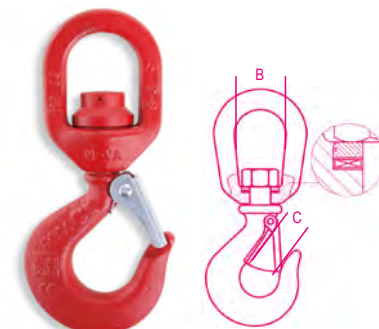

EN 1677-5

TECHNICAL DATA

- safety factor: 5
 - heat treatment: hardening and tempering
 - traceability code
- LABORATORY TESTS
- chemical analysis, metallographic analysis
 - proof load test (WLL x 2.5)
 - tensile test

- fatigue test (min. 20,000 cycles)

AVAILABLE CERTIFICATES

- Technical product specifications
- Test report UNI EN10204 type 2.2
- Inspection certificate UNI EN10204 type 3.1
- CE Declaration of Conformity

WLL	B	C	€	📄	📄
800	38	20	64,00	1	080650107
1000	38	22	69,50	1	080650110
1600	47	23	86,00	1	080650115
2000	47	27	98,50	1	080650120
3200	54	35	173,00	1	080650130
5000	72	43	256,00	1	080650150
7500	82	53	434,00	1	080650175

8062
slip hooks
alloy steel, painted

CE



TECHNICAL DATA

- safety factor: 5
- heat treatment: hardening and tempering
- traceability code

LABORATORY TESTS

- chemical analysis, metallographic analysis
- proof load test (WLL x 2.5)
- tensile test

AVAILABLE CERTIFICATES

- Technical product specifications
- Test report UNI EN10204 type 2.2
- Inspection certificate UNI EN10204 type 3.1
- CE Declaration of Conformity

WLL kg	C mm	F mm	€	📦	🖨️
1500	19	10-13	38,50	1	080620013
2000	21	16	54,50	1	080620016
3000	26	18	91,00	1	080620018
5000	34	22-25	121,50	1	080620025

8051S
lifting eye hooks,
carbon steel, galvanized

CE



GRADO 4

TECHNICAL DATA

- safety factor: 4
- heat treatment: normalizing
- traceability code

LABORATORY TESTS

- chemical analysis
- metallographic analysis
- tensile test

AVAILABLE CERTIFICATES

- Technical product specifications
- Test report UNI EN10204 type 2.2
- Inspection certificate UNI EN10204 type 3.1
- CE Declaration of Conformity

WLL kg	C mm	F mm	€	📦	🖨️
250	14	12	2,84	10	080510202
500	18	16,5	6,25	5	080510205

special free service boxes



WLL kg	📦	€	📦	🖨️
250	1	4,00	1	080519202
500	1	7,70	1	080519205



8100
lifting chains,
high-tensile alloy steel

CE

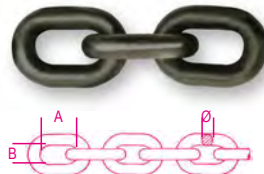

EN 818-2

TECHNICAL DATA

- safety factor: 4
- heat treatment: hardening and tempering
- traceability code

LABORATORY TESTS

- chemical analysis
- metallographic analysis
- tensile test

AVAILABLE CERTIFICATES

- Technical Product Specifications
- Test Report UNI EN10204 type 2.2
- Manufacturer's Certificate EN818-2
- CE Declaration of Conformity

WLL kg	📦	A mm	B min mm	€/m	📦	🖨️
1120	6	18	7,8	18,20	1	081000011
1500	7	21	11,0	23,30	1	081000016
2000	8	24	12,0	27,50	1	081000020
3150	10	30	14,5	41,00	1	081000032
5300	13	39	20,0	70,00	1	081000053
8000	16	48	20,8	106,50	1	081000080

8143
hand chain blocks

CE



EN13157

Technical Data:

- Safety factor: 4
- Identification tag

Available Certificates:

- Manufacturer's Certificate
- CE Declaration of Conformity
- Test Report UNI EN10204 type 2.2
- Technical Product Specifications

WLL t	📦	H mm	sforzo / effort kg	€	📦	🖨️
0,5	3	285	27	198,50	1	081430005
1	3	315	44	234,50	1	081430010
2	3	380	44	340,00	1	081430020
3	3	475	45	438,00	1	081430030
5	3	600	47	651,00	1	081430050

0,5	6	285	27	297,00	1	081430105
1	6	315	44	334,00	1	081430110
2	6	380	44	471,00	1	081430120
3	6	475	45	673,00	1	081430130
5	6	600	47	955,00	1	081430150



Robur

8146

lever hoists

CE



H

EN13157

TECHNICAL DATA

safety factor: 4

identification tag

AVAILABLE CERTIFICATES

Manufacturer's Certificate

CE Declaration of Conformity

Test Report UNI EN10204 type 2.2

Technical Product Specifications

WLL	t	L	H	sforzo / effort	€		
	t	mm	mm	kg			
0,75	1,5	320		21	241,50	1	081460008
1,5	1,5	380		41	345,00	1	081460015
3,0	1,5	480		41	461,00	1	081460030
6,0	1,5	600		46	749,00	1	081460060

0,75	3,0	320		21	271,00	1	081460108
1,5	3,0	380		41	383,00	1	081460115
3,0	3,0	480		41	529,00	1	081460130
6,0	3,0	600		46	898,00	1	081460160

8146C

lever hoist, compact

CE



H

EN13157

Technical data:

- Safety factor: 4
- Identification tag

Available Certificates:

- Manufacturer's Certificate
- CE Declaration of Conformity
- Test Report UNI EN10204 type 2.2
- Technical Product Specifications

WLL	t	L	H	sforzo / effort	€		
	t	mm	mm	kg			
0,25	1,5	230		20,7	223,00	1	081460002

8149S/A

hoist chain bag,
made of black fabric



A	C	8143	8143	€		
mm	mm	t	L			
			mm			
100	250	0,5 - 1	3/6 - 3/6	18,60	1	081490510
120	350	2 - 3	3/6 - 3	20,20	1	081490512
150	450	3 - 5	6 - 3/6	21,70	1	081490515

8135

steel plate lifting clamps
with articulated lifting eyes

CE



EN13155

TECHNICAL DATA

- Safety factor: 3
 - Serial number identification plate
- ### AVAILABLE CERTIFICATES
- Manufacturer's Certificate
 - CE Declaration of Conformity
 - Test report UNI EN10204 type 2.2
 - Technical product specifications

WLL	A	H	€		
t	mm	kg			
0,75	0-15	2	123,00	1	081350005
1,0	0-20	5	166,00	1	081350010
2,0	0-25	8	246,50	1	081350020
3,0	0-30	15	418,00	1	081350032
5,0	0-50	23	589,00	1	081350050

8120

Genovese chains
for static connections,
galvanised



TECHNICAL DATA

- safety factor: 4

AVAILABLE CERTIFICATES

- Technical product specifications
- Test report UNI EN10204 type 2.2

Ø mm	nr	WFL	€		
		kg			
		m			
1,5	10	8 150	170,50	1	081200015
1,6	12	15 150	177,50	1	081200016
2,2	14	25 75	104,00	1	081200022
2,7	16	40 75	128,50	1	081200027
3,0	17	55 75	142,00	1	081200030
3,4	18	100 60	142,00	1	081200034
3,8	19	110 50	137,00	1	081200038
4,4	20	200 40	127,00	1	081200044
4,8	21	250 30	118,00	1	081200048
5,5	22	300 25	118,00	1	081200055
5,8	23	310 25	134,00	1	081200058
6,5	24	400 25	151,50	1	081200065
7,5	26	550 20	165,00	1	081200075
* 8,0	27	600 25	238,50	1	081200080
* 9,0	28	800 25	300,00	1	081200090
* 10,0	30	1000 20	303,00	1	081200100
* 12,0	32	1400 15	321,00	1	081200120

Caution: product NOT designed for lifting purposes

(* available in COILS)

Robur

8120B

Genovese chains
for static connections,
galvanised



TECHNICAL DATA

- safety factor: 4
- AVAILABLE CERTIFICATES
- Technical product specifications
- Test report type 2.2 UNI EN10204

Ø mm	nr	WFL	m	€	U	IT
mm		kg				
1,5	10	8	200	212,00	1	081200315
1,6	12	15	200	224,00	1	081200316
2,2	14	25	100	132,50	1	081200322
2,7	16	40	100	169,50	1	081200327
3,0	17	55	75	141,50	1	081200330
3,4	18	100	100	225,00	1	081200334
3,8	19	110	75	196,00	1	081200338
4,4	20	200	50	152,00	1	081200344
4,8	21	250	50	196,00	1	081200348
5,5	22	300	40	183,00	1	081200355
5,8	23	310	30	156,50	1	081200358
6,5	24	400	30	178,50	1	081200365
7,5	26	550	25	198,50	1	081200375
8,0	27	600	15	153,50	1	081200380
9,0	28	800	15	181,00	1	081200390
10,0	30	1000	10	148,00	1	081200400
12,0	32	1400	8	171,50	1	081200420

Caution: NOT for lifting

8120D

calibrated chains DIN766
electrolytic galvanized
available in any length on request (>30m)



TECHNICAL DATA

- safety factor: 4
- AVAILABLE CERTIFICATES
- Technical product specifications
- Test report UNI EN10204 type 2.2

Ø mm	P	WFL	m	€	U	IT
mm	mm	kg				
4	16	200	30	106,50	1	081200640
5	18,5	320	30	150,00	1	081200650
6	18,5	400	30	227,50	1	081200660
7	22	630	30	273,00	1	081200670
8	24	800	30	362,00	1	081200680
10	28	1250	30	552,00	1	081200700

calibrated chains DIN766
HOT-DIP galvanized

Ø mm	P	WFL	m	€	U	IT
mm	mm	kg				
4	16	200	30	132,50	1	081200840
5	18,5	320	30	181,50	1	081200850
6	18,5	400	30	270,00	1	081200860
7	22	630	30	316,00	1	081200870
8	24	800	30	420,00	1	081200880
10	28	1250	30	635,00	1	081200900

8129

barrier chain,
made of galvanized metal painted in red and white



Ø mm	m	€	U	IT
5	30	225,00	1	081290050

Caution: NOT for lifting or anchoring

8074

carabine hooks,
galvanized

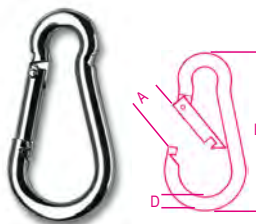

DIN 5299

TECHNICAL DATA

- safety factor: 4
- AVAILABLE CERTIFICATES
- Technical product specifications
- Test report UNI EN10204 type 2.2

DxL	A	WFL	€	U	IT
mm	mm	kg			
* 4x40	6	20	0,55	100	080740040
5x50	7	30	0,56	100	080740050
6x60	8	40	0,62	100	080740060
7x70	9	60	0,80	50	080740070
8x80	11	75	0,96	50	080740080
9x90	12	100	1,30	25	080740090
10x100	13	120	1,76	25	080740100
11x120	16	140	2,39	20	080740101
12x140	22	140	3,35	15	080740102
13x160	24	200	4,55	10	080740103
* 14x180	32	250	9,65	5	080740104

8074A

ring carabine hooks,
galvanized



DIN 5299

TECHNICAL DATA

- safety factor: 4
- AVAILABLE CERTIFICATES
- Technical product specifications
- Test report UNI EN10204 type 2.2

øAxL	D	WFL	€	U	IT
mm	mm	kg			
5x50	7,4	30	0,76	50	080740405
6x60	8,7	40	0,88	50	080740406
8x80	10,5	75	1,19	25	080740408
10x100	13,3	120	2,10	10	080740410

8074G

carabine hooks with screw nut,
galvanized

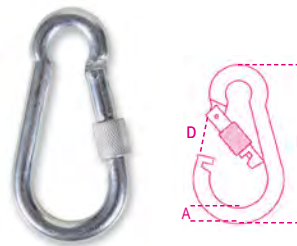

TECHNICAL DATA

- safety factor: 4
- AVAILABLE CERTIFICATES
- Technical product specifications
- Test report UNI EN10204 type 2.2

øAxL	D	WFL	€	U	IT
mm	mm	kg			
5x50	7,5	30	0,86	50	080740305
6x60	8,5	40	0,98	50	080740306
8x80	10,3	75	1,30	25	080740308
10x100	10,6	120	2,21	10	080740310

8080

quick links,
galvanized



TECHNICAL DATA

- safety factor: 4
- AVAILABLE CERTIFICATES
- Technical product specifications
- Test report UNI EN10204 type 2.2

DxL	A	WFL	€	U	IT
mm	mm	kg			
3,5x36	5	20	0,45	100	080800003
4x40	6	30	0,49	100	080800004
5x49	6	50	0,59	100	080800005
6x57	8	60	0,73	100	080800006
7x66	8	100	0,96	50	080800007
8x74	11	140	1,14	50	080800008
9x80	11	160	1,65	25	080800009
10x89	11	220	1,93	25	080800010
12x105	15	300	3,35	20	080800012
14x125	16,5	400	7,20	3	080800014

8080FM

missing links,
galvanized

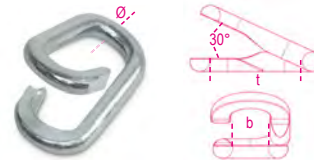

TECHNICAL DATA

- safety coefficient: 4
- AVAILABLE CERTIFICATES
- Technical product specifications
- Test report UNI EN10204 type 2.2

M	ød	b	t	€	U	IT
	mm	mm	mm			
4	3,8	8,6	21,5	0,35	100	080800204
5	4,7	11,1	25,8	0,58	50	080800205
6	5,3	13,8	32,0	1,12	30	080800206
7	6,5	16,8	37,0	1,34	10	080800207
8	8,0	18,0	38,0	1,97	10	080800208

8082

rings
galvanised steel

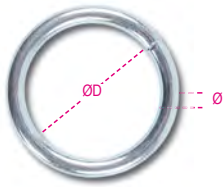

AVAILABLE CERTIFICATES:
Test Report UNI EN10204 type 2.2

Ø mm	ØD mm	€		
4	20	0,34	50	080820004
5	30	0,45	20	080820005
6	40	0,73	10	080820006
7	50	1,14	5	080820007
8	60	1,53	5	080820008

8083

S-hooks
galvanised steel



AVAILABLE CERTIFICATES:
Test report UNI EN10204 type 2.2

Ø mm	L mm	€		
3	33	0,07	100	080830003
4	40	0,10	60	080830004
5	47	0,19	50	080830005
6	59	0,35	30	080830006
8	79	0,89	10	080830008

8114

oblong eye swivels,
galvanized

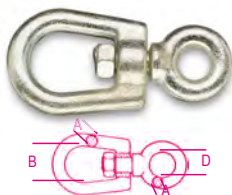

TECHNICAL DATA

- safety factor: 4
- traceability code

LABORATORY TESTS

- tensile test

AVAILABLE CERTIFICATES

- Technical product specifications
- Test report UNI EN10204 type 2.2
- Inspection certificate UNI EN10204 type 3.1

A mm	B mm	D mm	WFL kg	€		
8	30	16	250	3,60	10	081140008
10	38	18	300	6,70	10	081140010
12	42	20	650	9,75	5	081140012
14	48	22	820	15,00	5	081140014
16	57	24	1000	20,60	3	081140016
18	64	26	1600	24,60	3	081140018
20	72	30	2000	35,00	1	081140020
22	80	34	2500	48,50	1	081140022

8116

oblong eye & eye swivels,
galvanized

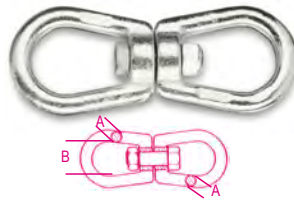

TECHNICAL DATA

- safety factor: 4
- traceability code

LABORATORY TESTS

- tensile test

AVAILABLE CERTIFICATES

- Technical product specifications
- Test report UNI EN10204 type 2.2
- Inspection certificate UNI EN10204 type 3.1

A mm	B mm	WFL kg	€		
6	23	140	3,90	10	081160006
8	30	250	4,85	10	081160008
10	38	300	8,85	5	081160010
12	42	650	14,60	5	081160012
14	48	820	21,80	3	081160014
16	57	1000	27,00	3	081160016
18	64	1600	33,00	1	081160018
20	72	2000	46,50	1	081160020
22	80	2500	72,50	1	081160022

8317SZ

simplex wire rope clips
galvanized



AVAILABLE CERTIFICATES

- Test report UNI EN10204 type 2.2

Ø mm	L mm	L1 mm	€		
2	15	14	0,22	100	083170102
3	18	16	0,23	100	083170103
4	20	19	0,32	100	083170104
5	24	23	0,36	50	083170105
6	30	27	0,43	30	083170106
8	36	34	0,83	20	083170108
10	42	37	1,25	10	083170110

8317DZ

duplex wire rope clips
galvanized



AVAILABLE CERTIFICATES

- Test report UNI EN10204 type 2.2

Ø mm	L mm	L1 mm	€		
2	30	14	0,29	50	083170002
3	35	15	0,39	50	083170003
4	40	18	0,45	50	083170004
5	50	21	0,57	25	083170005
6	60	25	0,76	20	083170006
8	76	33	1,65	10	083170008
10	95	37	2,49	10	083170010

8381SL

U bolts for pipes, light type,
galvanized

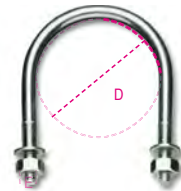

AVAILABLE CERTIFICATES

- Technical product specifications
- Test report UNI EN10204 type 2.2

D mm	D gas	E mm	€		
11	1/8"	M6	0,45	100	083810201
14	1/4"	M6	0,49	100	083810202
18	3/8"	M6	0,49	100	083810203
22	1/2"	M6	0,55	100	083810204
27	3/4"	M6	0,55	100	083810205
34	1"	M6	0,61	100	083810206
43	1 1/4"	M6	0,61	100	083810207
49	1 1/2"	M8	1,09	50	083810208
61	2"	M8	1,14	50	083810209
77	2 1/2"	M8	1,36	25	083810210
89	3"	M8	1,46	25	083810211
102	3 1/2"	M8	1,65	25	083810212
115	4"	M8	1,82	25	083810213
140	5"	M8	4,00	25	083810215
168	6"	M10	4,35	25	083810218
220	8"	M10	8,85	10	083810220

8381SP

U bolts for pipes, heavy type,
galvanized

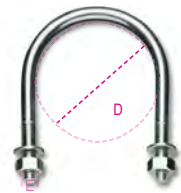

AVAILABLE CERTIFICATES

- Technical product specifications
- Test report UNI EN10204 type 2.2

D mm	D gas	E mm	€		
22	1/2"	M8	0,80	100	083810301
27	3/4"	M8	0,87	100	083810302
34	1"	M8	0,93	100	083810303
43	1 1/4"	M8	1,01	100	083810304
49	1 1/2"	M10	1,71	25	083810305
61	2"	M10	1,87	25	083810306
77	2 1/2"	M10	2,15	25	083810307
89	3"	M10	2,27	25	083810308
102	3 1/2"	M12	3,60	25	083810309
115	4"	M12	4,00	15	083810310
140	5"	M12	6,20	15	083810312
168	6"	M16	10,40	15	083810315
220	8"	M16	18,40	10	083810320
274	10"	M16	19,30	1	083810374
274	10"	M20	27,50	1	083810375
324	12"	M20	59,00	1	083810386
408	16"	M24	86,50	1	083810508



8383C

square U bolts,
hot galvanized
Flanged nuts

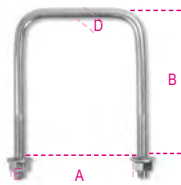

AVAILABLE CERTIFICATES
• Technical Product Specifications
• Test Report UNI EN10204 type 2.2

A	E	B	D	€		
mm	mm	mm	mm			
70	M10	110	8,55	1,82	130	083830070
80	M10	120	8,55	2,10	110	083830080
90	M10	130	8,55	2,27	100	083830090
100	M10	155	8,55	2,72	90	083830100
120	M10	175	8,55	3,15	70	083830120

8383P

plates for square U bolts
hot galvanized

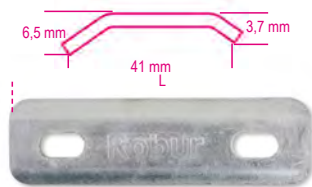

AVAILABLE CERTIFICATES
• Technical product specifications
• Test report UNI EN10204 type 2.2

	L	€		
	mm			
8383P 150	150	2,27	150	083830214
8383C/70-80	/90-100			
8383P 170	170	2,72	120	083830217
8383C/100-120				

8515Z

wire tenders, galvanized



Available Certificates
• Test Report UNI EN10204 type 2.2

D	H	L	€		
mm	mm	mm			
20	25	93	1,19	50	085150002
24,5	30	100	1,65	50	085150003

8515V

wire tenders,
galvanized and painted



Available Certificates
• Test Report UNI EN10204 type 2.2

D	H	L	€		
mm	mm	mm			
20	25	93	1,58	50	085150102
24,5	30	100	2,00	50	085150103

8515CH

wire tender keys,
galvanized



L	OA	OB	€		
mm	mm	mm			
90	8	7,5	0,57	20	085150901

8531

dee FISHING shackles,
hot-dip galvanized

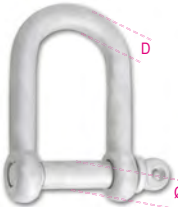

AVAILABLE CERTIFICATES
• Test report UNI EN10204 type 2.2

Ø	D	WFL	€		
mm	mm	kg			
20	18	1600	16,40	1	085310018
22	20	2500	23,90	1	085310020

8532

dee FISHING shackles
with square head screw pin,
black painted



AVAILABLE CERTIFICATES
• Test report UNI EN10204 type 2.2

Ø	D	WFL	€		
mm	mm	kg			
20	20	1600	8,05	1	085320020
22	22	2500	12,30	1	085320022

8535

fishing hooks,
galvanized

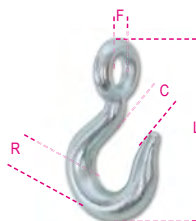

AVAILABLE CERTIFICATES
• Test report UNI EN10204 type 2.2

R	C	F	L	€		
mm	mm	mm	mm			
26	27,5	34	156	18,40	1	085350006
30	36,5	40	185	25,50	1	085350007

8130

antitheft chains, made of alloy steel,
case-hardened, tempered,
galvanized



AVAILABLE CERTIFICATES:
Test report UNI EN10204 type 2.2

Ø	L	€		
mm	mm			
6	800	13,60	1	081300068
8	1000	29,50	1	081300081
8	1200	33,50	1	081300082
10	1500	51,00	1	081300105

8130A

anti-theft chains with rings,
made of alloy steel, case-hardened, tempered,
galvanized



Ø	L	€		
mm	mm			
10	900	47,50	1	081300209

8131Z

antitheft chains with padlocks



Ø	L	8139Z	€		
mm	mm	Ø mm			
6	800	8	70,50	1	081310060
6	800	10	76,00	1	081310068
8	1000	10	92,00	1	081310081
8	1200	10	96,00	1	081310082
10	1500	10	113,50	1	081310105

8131DL

disc lock with anti-theft chain 8130A



Ø	L	€		
mm	mm			
10	900	108,50	1	081310209

8139DL

motorcycle disc locks,
made of hardened steel, shockproof PVC,
blister-packed

- supplied with 3 keys, signalling cable, case
- suitable for 10mm chains



ø mm	L mm	H mm	€		
14	108	56	61,00	1	081390214

8139Z

padlocks for antitheft chains,
zinc alloy bodies

- supplied with 3 mapped keys
- suitable for chains 6, 8, 10 mm



ø mm	L mm	H mm	€		
8	45	90	57,00	1	081390008
10	55	98	62,50	1	081390009

8139ZCH

3 neutral spare keys
for locks 8139Z



	€		
8139ZCH	19,30	1	081390909

suitable for locks ø8 and ø10

8050 D1÷D45

safety locks and spare parts kit for eye hooks



	€		
8050D1	7,40	1	080500945
8064S-8065SC/800			
8050D2	8,55	1	080500946
8064S-8065SC/1000			
8050D3	9,30	1	080500947
8064S-8065SC/1600-2000			
8050D4	15,30	1	080500948
8055S/5400 - 8064S-8065SC/3200			
8050D5	17,80	1	080500949
8055S/8000			
8064S-8065SC/5000			
8050D6	28,00	1	080500950
8055S/11500			
8064S/7500			

8050D11	14,70	1	080500955
8062/2000			
8050D12	16,20	1	080500956
8062/3000			
8050D13	29,00	1	080500957
8062/5000			
8050D22	38,50	1	080500966
8055S/16000			
8064S/10000			
8050D23	53,50	1	080500967
8055S/22000			
8050D24	0,68	1	080500969
8051S/250			
8050D25	0,80	1	080500970
8051S/500			
8050D29	21,50	1	080500974
8061F/5300			
8050D30	21,50	1	080500975
8061F/8000			
8050D32	29,50	1	080500977
8060/8000			
8050D33	2,96	1	080500978
8052/800			
8050D34	3,35	1	080500979
8052/1120			
8050D35	4,10	1	080500980
8052/2000			
8050D36	4,45	1	080500981
8052/3150			
8050D37	5,25	1	080500982
8052/4000			
8050D38	1,93	1	080500983
8060R/1120			
8050D53	2,62	1	080500994
8060R/1500			
8050D39	2,62	1	080500984
8060R/2000			
8050D40	4,55	1	080500985
8060R/3150			
8050D41	7,05	1	080500986
8060R/5300			
8050D42	0,68	1	080500987
8063/800			
8050D43	0,96	1	080500988
8063/1120			
8050D44	1,25	1	080500989
8063/2000			
8050D45	1,53	1	080500990
8063/3150			



8050D46	2,00	1	080500991
8061R/1120			
8050D47	2,00	1	080500992
8061R/2000			
8050D48	2,72	1	080500993
8061R/3150			
8050D54	2,72	1	080500995
8061R/5300			



8050 D49	5,50	1	080500849
8057R - 8058R - 8063SL /1120			
8050 D50	6,00	1	080500850
8057R - 8058R - 8063SL /2000			
8050 D51	6,55	1	080500851
8057R - 8058R - 8063SL /3150			
8050 D52	14,80	1	080500852
8057R - 8058R - 8063SL /5300			

8058R/PS

pin kit for hooks item 8058R-8061R



	ø mm	€		
8058R/PS	6	6,45	1	080580512
8058R/PS	7-8	7,40	1	080580520
8058R/PS	10	14,80	1	080580532
8058R/PS	13	25,50	1	080580553

8060R/PS

pin kit for hooks item 8060R



	ø mm	€		
8060R/PS	6	6,45	1	080600511
8060R/PS	7	7,40	1	080600515
8060R/PS	8	7,40	1	080600520
8060R/PS	10	14,80	1	080600532
8060R/PS	13	25,50	1	080600553

8143/RK

safety locks, pins and stops
for hand CHAIN blocks 8143



	€		
8143/RK 0,5t	7,90	1	081430905
8143/RK 1,0t	9,65	1	081430915
8143/RK 2,0t	13,00	1	081430920
8143/RK 3,0t	14,80	1	081430930
8143/RK 5,0t	17,10	1	081430950

8146/RK

safety locks, pins and stops
for hand LEVER hoists 8146C-8146



	€		
8146/RK 0,25t	5,70	1	081460902
8146/RK 0,75t	9,65	1	081460908
8146/RK 1,50t	11,90	1	081460915
8146/RK 3,00t	14,30	1	081460930
8146/RK 6,00t	16,50	1	081460960

8135/KGF

fixed jaws kit

Responsibility for repairs rests with repairer.



	8135 t	€		
8135/KGF	0,75	25,00	1	081350705
8135/KGF	1,00	43,00	1	081350710
8135/KGF	2,00	52,00	1	081350720
8135/KGF	3,00	67,50	1	081350730
8135/KGF	5,00	81,00	1	081350750

Beta
Quality Tools

8135/KGM

moving jaws kit

Responsibility for repairs rests with repairer.



	8135 t	€		
8135/KGM	0,75	82,00	1	081350805
8135/KGM	1,00	132,00	1	081350810
8135/KGM	2,00	169,50	1	081350820
8135/KGM	3,00	249,50	1	081350830
8135/KGM	5,00	358,00	1	081350850

8135/KLA

operating lever kit

Responsibility for repairs rests with repairer.



	8135 t	€		
8135/KLA	0,75	42,50	1	081350905
8135/KLA	1,00	51,00	1	081350910
8135/KLA	2,00	68,50	1	081350920
8135/KLA	3,00	83,00	1	081350930
8135/KLA	5,00	119,00	1	081350950

8149CM

hand chains for chain blocks 8143



Ø mm	B mm	t mm	€		
4,8	8,2	22,2	5,05	1	081490901

* CAUTION: Product is delivered in one length of chain, unless otherwise specified in order!



Breaking force (BF)
on technical specifications
WWW.ROBURITALY.COM

8205

eye and eye turnbuckle
AISI 316

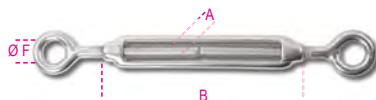

LABORATORY TESTS
• chemical analysis
• tensile test
AVAILABLE CERTIFICATES
• Technical product specifications
• Test report UNI EN10204 type 2.2

A mm	B mm	Ø F mm	WFL kg	€		
M4	62	8	75	5,25	10	082050204
M5	72	11	115	6,25	10	082050205
M6	92	12	160	8,30	5	082050206
M8	122	14	300	12,80	5	082050208
M10	150	16	470	19,20	1	082050210
M12	201	18	690	33,00	1	082050212
M14	225	22	940	81,50	1	082050214
M16	244	26	1290	83,50	1	082050216
M20	295	29	2130	120,50	1	082050220
M24	350	33	3000	275,00	1	082050224

8206

hook and eye turnbuckle
AISI 316

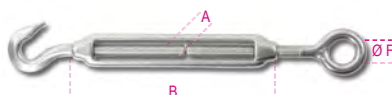

LABORATORY TESTS
• chemical analysis
• tensile test
AVAILABLE CERTIFICATES
• Technical product specifications
• Test report UNI EN10204 type 2.2

A mm	B mm	Ø F mm	WFL kg	€		
M5	72	11	25	6,35	10	082060205
M6	92	12	45	8,75	5	082060206
M8	122	14	95	13,30	5	082060208
M10	150	16	140	20,40	1	082060210
M12	201	18	300	34,00	1	082060212
M14	225	22	420	82,00	1	082060214
M16	244	26	570	84,00	1	082060216
M20	295	29	875	122,50	1	082060220

8207

hook and hook turnbuckle
AISI 316

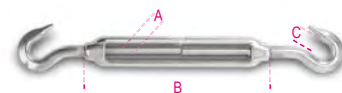

LABORATORY TESTS
• chemical analysis
• tensile test
AVAILABLE CERTIFICATES
• Technical product specifications
• Test report UNI EN10204 type 2.2

A mm	B mm	C mm	WFL kg	€		
M5	72	9	25	6,70	10	082070205
M6	92	9	45	8,85	5	082070206
M8	122	10	95	13,60	5	082070208
M10	150	12	140	20,80	1	082070210
M12	201	14	300	34,50	1	082070212
M14	225	15	420	83,50	1	082070214
M16	244	16	570	86,00	1	082070216
M20	295	19	875	126,50	1	082070220

8209

jaw and jaw turnbuckle
AISI 316

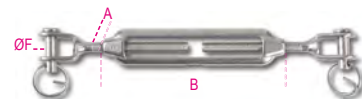

LABORATORY TESTS
• chemical analysis
• tensile test
AVAILABLE CERTIFICATES
• Technical product specifications
• Test report UNI EN10204 type 2.2

A mm	B mm	Ø F mm	WFL kg	€		
M5	72	5	115	11,20	5	082090205
M6	92	6	160	13,10	5	082090206
M8	122	8	300	18,90	5	082090208
M10	150	10	470	31,00	1	082090210
M12	201	12	690	50,00	1	082090212
M14	225	14	940	67,50	1	082090214
M16	244	16	1290	102,00	1	082090216
M20	295	20	2130	179,50	1	082090220
M24	350	24	3060	435,00	1	082090224

Robur

Robur

8210

jaw and jaw pipe turnbuckle
AISI 316

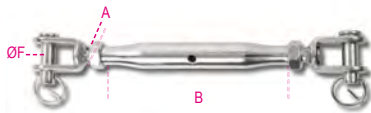

LABORATORY TESTS

- chemical analysis
- tensile test

AVAILABLE CERTIFICATES

- Technical product specifications
- Test report UNI EN10204 type 2.2

A	B	ØF	WFL	€		
mm	mm	mm	kg			
M5	81	5	115	14,10	3	082100205
M6	92	6	160	17,00	3	082100206
M8	112	8	300	24,80	1	082100208
M10	121	10	470	38,50	1	082100210
M12	150	12	690	64,50	1	082100212
M14	169	14	940	83,50	1	082100214
M16	190	16	1290	123,50	1	082100216
M20	220	20	2130	214,50	1	082100220

8201T

pipe bodies
AISI 316



LABORATORY TESTS

- chemical analysis
- tensile test

AVAILABLE CERTIFICATES

- Technical Product Specifications
- Test Report UNI EN10204 type 2.2

Ø	Ø	WFL	L	€		
mm	mm	kg	mm			
M6	1/4	160	95	3,15	5	082010406
M8	5/16	300	105	4,60	5	082010408
M10	3/8	470	125	7,75	3	082010410
M12	1/2	690	150	13,60	3	082010412
M14	9/16	940	165	14,50	1	082010414
M16	5/8	1290	190	24,90	1	082010416
M20	3/4	2130	210	37,00	1	082010420

8210F

turnbuckle jaws,
stainless steel AISI 316

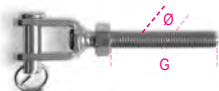

LABORATORY TESTS

- chemical analysis
- tensile test

AVAILABLE CERTIFICATES

- Technical product specifications
- Test report UNI EN10204 type 2.2

Ø	≈	G	WFL	€		
mm	mm	mm	kg			
M5	3/16	38,5	115	4,65	4	082100305
M6	1/4	49	160	5,25	4	082100306
M8	5/16	56	300	7,60	4	082100308
M10	3/8	61	470	13,00	2	082100310
M12	1/2	81	690	20,50	2	082100312
M14	9/16	93	940	32,50	2	082100314

left-handed thread

Ø	≈	G	WFL	€		
mm	mm	mm	kg			
M5	3/16	38,5	115	4,65	4	082100405
M6	1/4	49	160	5,25	4	082100406
M8	5/16	56	300	7,60	4	082100408
M10	3/8	61	470	13,00	2	082100410
M12	1/2	81	690	20,50	2	082100412
M14	9/16	93	940	32,50	2	082100414

8248

eye tie rods,
stainless steel 316L,
right thread



UNI 6058

AVAILABLE CERTIFICATES

- Technical Product Specifications
- Test Report UNI EN10204 type 2.2

ØxL	F	€		
mm	mm			
8X120	6	6,10	1	082480008
10x80	8	8,20	1	082480010
10x130	8	10,90	1	082480012
12x95	10	12,40	1	082480016
12x125	10	14,80	1	082480018

8249

fastening eyebolts, right thread
AISI 316



LABORATORY TESTS

- chemical analysis
- tensile test

AVAILABLE CERTIFICATES

- Technical product specifications
- Test report UNI EN10204 type 2.2

A	ØB	D	WFL	€		
mm	mm	mm	kg			
M5	11	50	100	2,27	10	082490205
M6	13	55	160	2,84	10	082490206
M8	17	60	300	4,55	5	082490208
M10	21	80	470	8,20	5	082490210
M12	25	120	690	14,30	2	082490212

8249G

fastening hooks
AISI 316

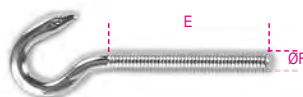

LABORATORY TESTS

- chemical analysis
- tensile test

AVAILABLE CERTIFICATES

- Technical Product Specifications
- Test Report UNI EN10204 type 2.2

A	E	ØF	WFL	€		
mm	mm	mm	kg			
M5	39	9	25	1,09	5	082490305
M6	43	10,5	45	1,30	5	082490306
M8	57	14,5	95	2,27	3	082490308

8216

wire rope clips
AISI 316

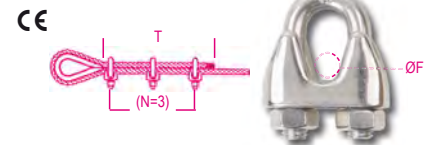

LABORATORY TESTS

- chemical analysis
- torque test

AVAILABLE CERTIFICATES

- Technical product specifications
- Test report UNI EN10204 type 2.2
- CE Certificate of Conformity

ØF	"	T	N	€		
mm						
2	5/64	80	3	2,62	15	082160202
3	1/8	80	3	2,67	15	082160203
4	5/32	80	3	3,00	10	082160204
5	3/16	110	3	3,40	10	082160205
6	1/4	120	5	3,80	10	082160206
8	5/16	210	5	5,05	5	082160208
10	3/8	240	5	7,05	5	082160210
12-13	1/2	300	5	9,85	5	082160213
16	5/8	335	5	14,50	5	082160216
20	3/4	540	5	18,30	5	082160220
22	7/8	595	7	29,50	3	082160222

special free service boxes



ØF		€		
mm				
2	4	11,10	1	082169402
3	4	11,20	1	082169403
4	4	12,60	1	082169404
5	2	7,60	1	082169405
6	2	8,55	1	082169406
8	2	11,10	1	082169408
10	2	15,00	1	082169410

8220

thimbles
AISI 316

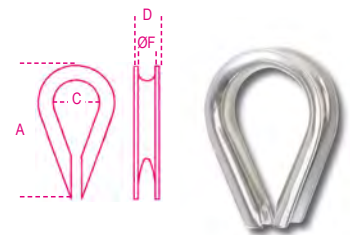

LABORATORY TESTS

- chemical analysis

AVAILABLE CERTIFICATES

- Technical product specifications
- Test report UNI EN10204 type 2.2

ØF	D	A	C	€		
mm	mm	mm	mm			
2	4,5	21	7,5	0,86	15	082200202
3	6	24	10	0,94	15	082200203
4	6,6	28	11	1,09	10	082200204
5	8,5	30	13	1,30	10	082200205
6	10	37	15	1,48	10	082200206
8	12,5	51	23	2,33	5	082200208
10	14,6	56	27	2,84	5	082200210
12	18	68	32	3,90	5	082200212
14	19	69	34	5,05	5	082200214
16	22	83	37	5,70	5	082200216
18	23	81	38	6,70	1	082200218
20	27,8	105	45	7,90	1	082200220
22	29,6	112	45	10,30	1	082200222

8225

dee shackles
AISI 316



LABORATORY TESTS

- chemical analysis
- tensile test

AVAILABLE CERTIFICATES

- Technical product specifications
- Test report UNI EN10204 type 2.2

ø D mm	"	A mm	WFL kg	€		
4	5/32	8	50	2,78	10	082250204
5	3/16	11	70	3,05	10	082250205
6	1/4	13	100	3,35	5	082250206
8	5/16	17	250	5,40	5	082250208
10	3/8	21	400	7,75	3	082250210
12	1/2	25	600	12,80	3	082250212
16	5/8	32	1000	28,00	1	082250216
19	3/4	38	1600	46,50	1	082250219
22	7/8	43	2000	73,00	1	082250222
25	1	46	2800	106,00	1	082250225

8227

long dee shackles
AISI 316



LABORATORY TESTS

- chemical analysis
- tensile test

AVAILABLE CERTIFICATES

- Technical product specifications
- Test report UNI EN10204 type 2.2

ø D mm	"	A mm	WFL kg	€		
4	5/32	8	50	2,33	10	082270204
5	3/16	10	70	2,67	10	082270205
6	1/4	13,5	100	3,40	5	082270206
8	5/16	17	250	5,55	5	082270208
10	3/8	21	400	9,20	2	082270210
12	1/2	25	600	14,60	1	082270212

8228

bow shackles
AISI 316

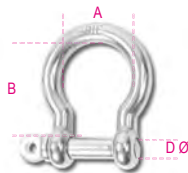

LABORATORY TESTS

- chemical analysis
- tensile test

AVAILABLE CERTIFICATES

- Technical product specifications
- Test report UNI EN10204 type 2.2

ø D mm	A mm	B mm	WFL kg	€		
4	13	20	60	2,10	10	082280204
5	17	23	80	2,44	10	082280205
6	20	27	100	2,78	10	082280206
8	28	36	200	4,45	5	082280208
10	36	44	300	7,05	5	082280210
12	41	53	500	11,30	5	082280212
16	54	74	800	25,00	1	082280216
19	66	86	1100	45,50	1	082280219

8240F

lifting eye bolts, FORGED
stainless steel A4

CE



TECHNICAL DATA

- safety factor: 6

- traceability code

LABORATORY TESTS

- chemical analysis
- metallographic analysis
- tensile test

AVAILABLE CERTIFICATES

- Technical product specifications
- Test report UNI EN10204 type 2.2
- Inspection certificate UNI EN10204 type 3.1
- CE Declaration of Conformity

ø mm	WLL mm	WLL kg	€		
* M6	1,0	120	6,35	4	082400406
* M8	1,25	200	7,05	4	082400408
* M10	1,5	400	11,90	4	082400410
* M12	1,75	600	19,30	4	082400412
* M14	2	1000	31,00	2	082400414
* M16	2	1200	31,00	2	082400416
* M20	2,5	2000	50,00	2	082400420
* M24	3	2700	95,00	2	082400424
* M30	3,5	4000	210,00	1	082400430

(*) WLL increased compared to DIN standard according to Technical Specifications R/FT/8240F (guaranteed for stainless steel / stainless steel fits)

8240

eye bolts,
stainless steel AISI 316



LABORATORY TESTS

- chemical analysis
- tensile test

AVAILABLE CERTIFICATES

- Technical product specifications
- Test report UNI EN10204 type 2.2

A mm	B mm	ø C mm	WFL kg	€		
M6	41	15	90	1,82	10	082400206
M8	50	20	140	2,72	10	082400208
M10	62	25	230	5,45	5	082400210
M12	74	30	340	9,20	5	082400212

8242F

lifting eye nuts, FORGED
stainless steel A4

CE



TECHNICAL DATA

- safety factor: 6

- traceability code

LABORATORY TESTS

- chemical analysis
- metallographic analysis
- tensile test

AVAILABLE CERTIFICATES

- Technical product specifications
- Test report UNI EN10204 type 2.2
- Inspection certificate UNI EN10204 type 3.1
- CE Declaration of conformity

ø mm	WLL mm	WLL kg	€		
* M6	1,0	120	6,35	4	082420406
* M8	1,25	200	7,05	4	082420408
* M10	1,5	400	11,90	4	082420410
* M12	1,75	600	19,30	4	082420412
* M14	2	1000	31,00	2	082420414
* M16	2	1200	31,00	2	082420416
* M20	2,5	2000	50,00	2	082420420
* M24	3	2700	95,00	2	082420424
* M30	3,5	4000	210,00	1	082420430

(*) WLL ø M10÷M24 - increased according to Technical File R/FT/8242F - guaranteed with stainless steel coupling



8242
eye nuts
stainless steel AISI 316



A	B	ø C	WFL	€	🔧	🚚
mm	mm	mm	kg			
M6	27	15	90	1,82	10	082420206
M8	36	20	140	2,72	10	082420208
M10	45	25	230	5,45	5	082420210
M12	55	30	340	9,20	5	082420212

8274
carabine hooks
AISI 316

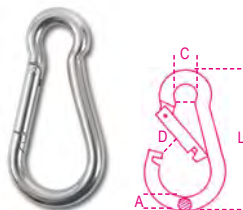

LABORATORY TESTS
• chemical analysis
• tensile test
AVAILABLE CERTIFICATES
• Technical product specifications
• Test report UNI EN10204 type 2.2

ø A x L	ø C	D	WFL	€	🔧	🚚
mm	mm	mm	kg			
4,5x40	6,5	6	20	2,49	10	082740204
5x50	7	6,5	30	2,49	10	082740205
6x60	8,5	7,5	40	2,62	5	082740206
7x70	10	9	60	3,15	5	082740207
8x80	12	10	75	4,20	5	082740208
9x90	12,5	10,5	100	5,75	5	082740209
10x100	15	13	120	7,20	2	082740210
11x120	19	18	140	10,30	1	082740211
12x140	22	21	140	14,00	1	082740212
13x160	22	26	200	17,60	1	082740213

8274A
ring carabine hooks
AISI 316

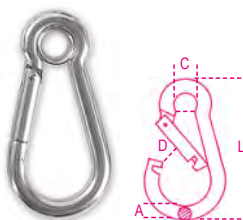

LABORATORY TESTS
• chemical analysis
• tensile test
AVAILABLE CERTIFICATES
• Technical Product Specifications
• Test Report UNI EN10204 type 2.2

ø A x L	ø C	D	WFL	€	🔧	🚚
mm	mm	mm	kg			
5x50	6,5	7	30	2,44	10	082740405
6x60	7,5	7,5	40	2,96	5	082740406
8x80	9,5	10	75	4,85	5	082740408

8274G
carabine hooks with screw nut
AISI 316

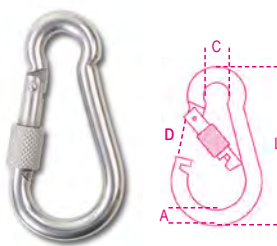

LABORATORY TESTS
• chemical analysis
• tensile test
AVAILABLE CERTIFICATES
• Technical product specifications
• Test report UNI EN10204 type 2.2

ø A x L	ø C	D	WFL	€	🔧	🚚
mm	mm	mm	kg			
6x60	8,5	6,5	40	3,25	5	082740306
8x80	12	8,5	75	5,80	5	082740308
10x100	15	12	120	11,10	3	082740310

8276
asymmetric carabine hooks
AISI 316

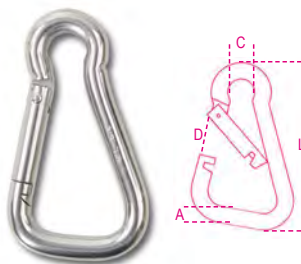

LABORATORY TESTS
• chemical analysis
• tensile test
AVAILABLE CERTIFICATES
• Technical product specifications
• Test report UNI EN10204 type 2.2

ø A x L	ø C	D	WFL	€	🔧	🚚
mm	mm	mm	kg			
6x60	8,5	10	40	2,96	5	082760206
8x80	12	14	75	5,05	5	082760208
10x100	15	18	120	8,95	3	082760210



8276G
asymmetric carabine hooks with screw nut
AISI 316

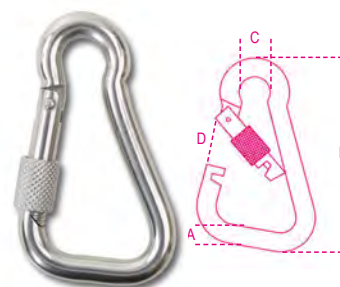

LABORATORY TESTS
• chemical analysis
• tensile test
AVAILABLE CERTIFICATES
• Technical product specifications
• Test report UNI EN10204 type 2.2

ø A x L	ø C	D	WFL	€	🔧	🚚
mm	mm	mm	kg			
6x60	8,5	9	40	3,75	3	082760306
8x80	12	12,5	75	6,70	3	082760308
10x100	15	16	120	12,30	3	082760310

8278
trapezoidal carabine hooks
AISI 316

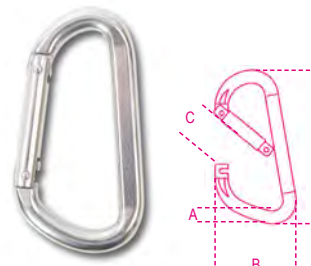

LABORATORY TESTS
• chemical analysis
• tensile test
AVAILABLE CERTIFICATES
• Technical product specifications
• Test report UNI EN10204 type 2.2

ø A x L	B	C	WFL	€	🔧	🚚
mm	mm	mm	kg			
8x80	45	14	75	11,30	3	082780208
10x100	55	16	120	17,60	3	082780210



8280

quick links
AISI 316

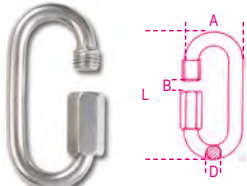

LABORATORY TESTS

- chemical analysis
- tensile test

AVAILABLE CERTIFICATES

- Technical product specifications
- Test report UNI EN10204 type 2.2

ø D x L mm	A mm	B mm	WFL kg	€		
3,5x35	17	5	20	2,89	10	082800203
4x40	19	6	30	3,05	10	082800204
5x50	23	7	50	3,75	5	082800205
6x60	26	8	60	4,45	5	082800206
7x70	30	9	100	5,05	5	082800207
8x80	33	10	140	7,15	2	082800208
10x90	40	12	220	11,60	2	082800210
12x100	47	14	300	17,60	1	082800212

8250

spring snap-casting eye end
AISI 316



LABORATORY TESTS

- chemical analysis
- tensile test

AVAILABLE CERTIFICATES

- Technical product specifications
- Test report UNI EN10204 type 2.2

L mm	A mm	ø B mm	WFL kg	€		
50	25	8	40	3,60	5	082500205
70	31	12,5	90	5,50	5	082500207
100	47	20	190	8,95	2	082500210

8264

swivel eye bolt snap
AISI 316

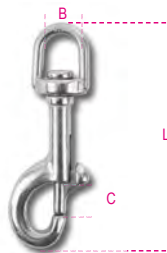

LABORATORY TESTS

- chemical analysis
- tensile test

AVAILABLE CERTIFICATES

- Technical product specifications
- Test report UNI EN10204 type 2.2

B mm	L mm	C mm	WFL kg	€		
12	88	12	60	9,75	5	082640212
16	90	12	60	10,00	5	082640216
19	93	12	60	10,10	2	082640219

8267

swivel eye snap
AISI 316



LABORATORY TESTS

- chemical analysis
- tensile test

AVAILABLE CERTIFICATES

- Technical product specifications
- Test report UNI EN10204 type 2.2

A mm	L mm	B mm	WFL kg	€		
10	87	21	30	8,55	5	082670210
12	118	22	70	14,40	2	082670213

8272

eye and eye swivels
AISI 316

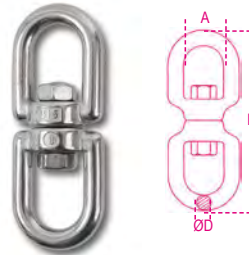

LABORATORY TESTS

- chemical analysis
- tensile test

AVAILABLE CERTIFICATES

- Technical product specifications
- Test report UNI EN10204 type 2.2

ø D mm	A mm	L mm	WFL kg	€		
4	11	50	90	4,85	5	082720204
5	13	60	115	6,35	5	082720205
6	15	66	140	7,80	5	082720206
8	19	90	250	12,60	3	082720208
10	23	112	300	19,40	1	082720210
13	33	148	650	39,00	1	082720213
16	38	184	1000	73,50	1	082720216
19	40	223	1600	130,50	1	082720219

8273

quick-release hooks
with swivel eyes
AISI 316 stainless steel



LABORATORY TESTS

- chemical analysis
- tensile test

AVAILABLE CERTIFICATES

- Technical product specifications
- Test report UNI EN10204 type 2.2

ø C x L mm	B mm	WFL kg	BF kg	€		
12x70	12	230	1100	14,80	1	082730012
16x85	14,50	440	2000	20,50	1	082730016
22x120	20	700	3500	32,50	1	082730022

8282S

S-hooks, symmetric
AISI 316 stainless steel

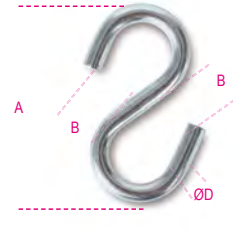

LABORATORY TESTS

- chemical analysis
- tensile test

AVAILABLE CERTIFICATES

- Product specifications
- Test report type 2.2 UNI EN10204

ø D mm	B mm	A mm	WFL kg	€		
3	5,5	34	4	0,27	40	082820303
4	7,0	40	5	0,52	30	082820304
5	9,0	46	12	0,86	20	082820305
6	10	54	18	1,43	15	082820306

8284

pelican hooks terminals
AISI 316 stainless steel



LABORATORY TESTS

- chemical analysis
- tensile test

AVAILABLE CERTIFICATES

- Technical product specifications
- Test report UNI EN10204 type 2.2

ø C mm	B mm	L mm	WFL kg	€		
6	11	73	200	14,30	3	082840006
8	14	98	300	19,30	3	082840008
10	23	143	450	40,00	1	082840010

8285

jaw terminals
AISI 316

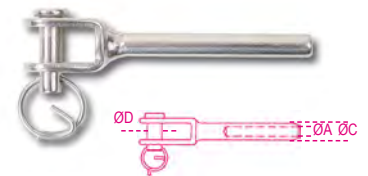

LABORATORY TESTS

- chemical analysis
- tensile test

AVAILABLE CERTIFICATES

- Technical product specifications
- Test report UNI EN10204 type 2.2

ø A mm	ø C mm	ø D mm	WFL kg	€		
3	6,3	6	180	2,84	5	082850203
4	7,5	6	200	4,55	3	082850204
5	9	10	330	6,25	2	082850205
6	12,5	12	720	13,00	2	082850206
8	16	13	1120	18,70	2	082850208

8286

eye terminals
AISI 316



LABORATORY TESTS

- chemical analysis
- tensile test

AVAILABLE CERTIFICATES

- Technical product specifications
- Test report UNI EN10204 type 2.2

Ø D mm	Ø A mm	Ø C mm	WFL kg	€		
3	6,5	6,3	180	2,96	5	082860203
4	8,5	7,5	200	3,40	3	082860204
5	10,6	9	330	4,55	2	082860205
6	13	12,5	720	7,50	2	082860206
8	14,7	16	1120	13,60	2	082860208

8287

swage studs
AISI 316

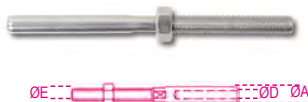

LABORATORY TESTS

- chemical analysis
- tensile test

AVAILABLE CERTIFICATES

- Technical product specifications
- Test report UNI EN10204 type 2.2

Ø D mm	Ø A mm	E mm	WFL kg	€		
3	6,3	M6	180	2,56	5	082870203
4	7,5	M8	200	3,60	3	082870204
5	9	M10	330	5,05	2	082870205
6	12,5	M12	720	9,30	2	082870206
8	16	M16	1120	18,70	2	082870208

8290

pad eyes
AISI 316



LABORATORY TESTS

- chemical analysis

AVAILABLE CERTIFICATES

- Technical product specifications
- Test report UNI EN10204 type 2.2

Ø A mm	B mm	Ø C mm	L mm	€		
5	18	4,3	40	0,91	5	082900205
6	22	5,2	44	1,30	5	082900206
8	23	5,2	51	2,05	5	082900208

8381SX

U bolts for pipes

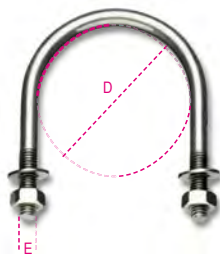

AISI 304

LABORATORY TESTS

- chemical analysis

AVAILABLE CERTIFICATES

- Test report UNIEN10204 type 2.2

D mm	D gas	E mm	€		
11	1/8"	M6	2,27	20	083810401
14	1/4"	M6	2,33	20	083810402
18	3/8"	M6	2,39	20	083810403
22	1/2"	M6	2,44	20	083810404
27	3/4"	M6	2,49	20	083810405
34	1"	M6	2,62	20	083810406
43	1 1/4"	M6	3,00	20	083810407
49	1 1/2"	M8	5,40	10	083810408
61	2"	M8	5,95	10	083810409
77	2 1/2"	M8	6,85	10	083810410
89	3"	M8	7,60	10	083810412
115	4"	M8	9,85	10	083810413
168	6"	M10	18,70	1	083810416
220	8"	M10	22,70	1	083810418

8279

Genovese chains
for static connections,
AISI 304 stainless steel



TECHNICAL DATA

- safety factor: 4

AVAILABLE CERTIFICATES

- Technical product specifications
- Test report UNI EN10204 type 2.2

Ø mm	nr	WFL kg	m	€		
2	13	20	50	221,00	1	082790020
3	17	55	50	403,00	1	082790030
4	19	100	50	568,00	1	082790040
5	21	250	40	608,00	1	082790050
6	23	310	30	619,00	1	082790060
8	27	400	15	608,00	1	082790080
10	30	1000	10	952,00	1	082790400

Caution: product NOT designed for lifting purposes

8293

ratchet tie downs AISI 304
high-tenacity polyester belt, LC 300 kg,
with hooks

hangable

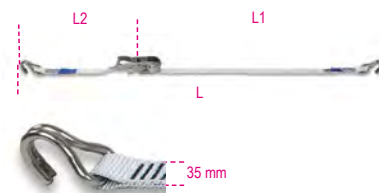

L m	L2 mm	L1 mm	STF daN	€		
6	5700	300	100	63,50	1	082930106

LC = 300 kg

8297C

ratchet tie downs,
with mini-ratchets, AISI 304
high-tenacity polyester belt, LC 700 kg

hangable

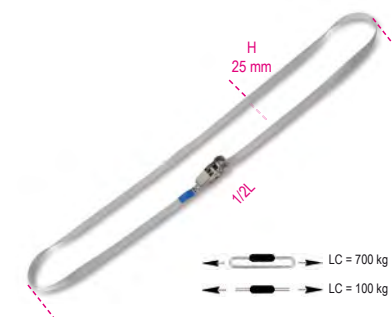

L m	H mm	€		
5	25	34,00	1	082970350

8297F

2 cam buckle straps,
AISI 304,
high-tenacity polyester belt, LC 250 kg

hangable

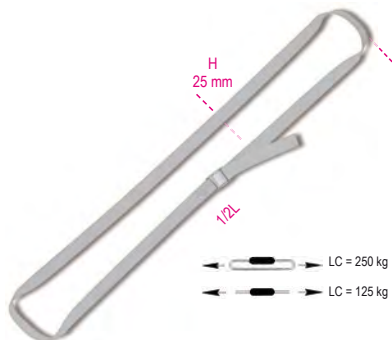

L m	H mm	€		
3	25	34,00	1	082970230

LC = 250 kg



POLYESTER SLINGS

TECHNICAL DATA

- safety factor: 7
- traceability code

LABORATORY TESTS

- tensile test

AVAILABLE CERTIFICATES

- Technical product specifications
- Test report UNI EN10204 type 2.2
- Manufacturer's Certificate UNI EN1492
- CE Declaration of Conformity

				$\beta = 0^\circ + 45^\circ$ 	$\beta = 45^\circ + 60^\circ$
30	1 t	0,8 t	2 t	1,4 t	1 t
60	2 t	1,6 t	4 t	2,8 t	2 t
90	3 t	2,4 t	6 t	4,2 t	3 t
120	4 t	3,2 t	8 t	5,6 t	4 t
150	5 t	4,0 t	10 t	7,0 t	5 t
180	6 t	4,8 t	12 t	8,4 t	6 t
240	8 t	6,4 t	16 t	11,2 t	8 t
300	10 t	8,0 t	20 t	14,0 t	10 t

8150

lifting web slings, purple 1t
two layers with reinforced eyes
high-tenacity polyester (PES) belt

CE



UNI EN 1492-1

L m	H mm	WLL ton	€	U	U
0,5	30	1	5,45	1	081500005
1	30	1	6,80	1	081500010
1,5	30	1	8,80	1	081500015
2	30	1	9,90	1	081500020
2,5	30	1	11,90	1	081500025
3	30	1	13,50	1	081500030
4	30	1	17,20	1	081500040
5	30	1	21,00	1	081500050
6	30	1	24,20	1	081500060
8	30	1	32,00	1	081500080

Robur

8153

lifting web slings, green 2t
two layers with reinforced eyes
high-tenacity polyester (PES) belt

CE



UNI EN 1492-1

L m	H mm	WLL ton	€	U	U
1	60	2	11,90	1	081530010
1,5	60	2	16,00	1	081530015
2	60	2	18,10	1	081530020
2,5	60	2	21,40	1	081530025
3	60	2	24,50	1	081530030
4	60	2	30,50	1	081530040
5	60	2	37,50	1	081530050
6	60	2	43,50	1	081530060
8	60	2	56,00	1	081530080
10	60	2	69,50	1	081530100

8156

lifting web slings, yellow 3t
two layers with reinforced eyes
high-tenacity polyester (PES) belt

CE

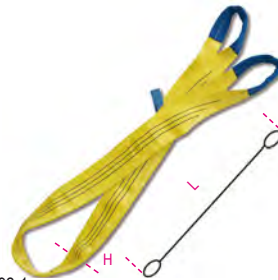

UNI EN 1492-1

L m	H mm	WLL ton	€	U	U
1	90	3	16,50	1	081560010
1,5	90	3	22,20	1	081560015
2	90	3	27,00	1	081560020
2,5	90	3	32,00	1	081560025
3	90	3	37,50	1	081560030
4	90	3	46,50	1	081560040
5	90	3	56,50	1	081560050
6	90	3	66,00	1	081560060
8	90	3	85,50	1	081560080
10	90	3	104,50	1	081560100
12	90	3	131,50	1	081560120

8157

lifting web slings, grey 4t
two layers with reinforced eyes
high-tenacity polyester (PES) belt

CE



UNI EN 1492-1

L m	H mm	WLL ton	€	U	U
2	120	4	37,50	1	081570020
3	120	4	50,00	1	081570030
4	120	4	64,00	1	081570040
5	120	4	77,00	1	081570050
6	120	4	90,00	1	081570060
8	120	4	118,50	1	081570080
10	120	4	146,00	1	081570100
12	120	4	182,00	1	081570120

8158

lifting web slings, red 5t
two layers with reinforced eyes
high-tenacity polyester (PES) belt

CE



UNI EN 1492-1

L m	H mm	WLL ton	€	U	U
2	150	5	50,50	1	081580020
3	150	5	68,50	1	081580030
4	150	5	86,00	1	081580040
5	150	5	103,50	1	081580050
6	150	5	121,50	1	081580060
8	150	5	157,50	1	081580080
10	150	5	193,00	1	081580100
12	150	5	242,00	1	081580120

Robur

Robur

8159

lifting web slings, brown 6t
two layers with reinforced eyes
high-tenacity polyester (PES)

CE



UNI EN 1492-1

L m	H mm	WLL ton	€	🚚	📦
2	180	6	64,00	1	081590020
3	180	6	94,50	1	081590030
4	180	6	119,00	1	081590040
5	180	6	144,50	1	081590050
6	180	6	169,50	1	081590060
8	180	6	220,00	1	081590080
10	180	6	274,00	1	081590100

8160

lifting web slings, blue 8t
two layers with reinforced eyes
high-tenacity polyester (PES)

CE



UNI EN 1492-1

L m	H mm	WLL ton	€	🚚	📦
3	240	8	129,00	1	081600030
4	240	8	170,50	1	081600040
5	240	8	196,00	1	081600050
6	240	8	231,50	1	081600060
8	240	8	299,00	1	081600080
10	240	8	370,00	1	081600100

8161

lifting web slings, orange 10t
two layers with reinforced eyes
high-tenacity polyester (PES)

CE



UNI EN 1492-1

L m	H mm	WLL ton	€	🚚	📦
3	300	10	168,00	1	081610030
4	300	10	257,00	1	081610040
5	300	10	307,00	1	081610050

L m	H mm	WLL ton	€	🚚	📦
6	300	10	357,00	1	081610060
8	300	10	472,00	1	081610080
10	300	10	584,00	1	081610100
12	300	10	698,00	1	081610120

8170

lifting round slings, purple 1t
high-tenacity polyester (PES) belt

CE



UNI EN 1492-2

L m	WLL ton	H mm	€	🚚	📦
0,5	1	45	5,65	1	081700010
1	1	45	7,50	1	081700020
1,5	1	45	10,70	1	081700030
2	1	45	13,60	1	081700040
3	1	45	19,90	1	081700060
4	1	45	26,00	1	081700080
5	1	45	32,50	1	081700100

8173

lifting round slings, green 2t
high-tenacity polyester (PES) belt

CE



UNI EN 1492-2

L m	H mm	WLL ton	€	🚚	📦
0,5	50	2	7,50	1	081730010
1	50	2	11,40	1	081730020
1,5	50	2	17,10	1	081730030
2	50	2	22,20	1	081730040
2,5	50	2	27,00	1	081730050
3	50	2	32,00	1	081730060
4	50	2	42,50	1	081730080
5	50	2	54,00	1	081730100
6	50	2	64,50	1	081730120
8	50	2	84,50	1	081730160

Robur

8176

lifting round slings, yellow 3t
high-tenacity polyester (PES) belt

CE



UNI EN 1492-2

L m	H mm	WLL ton	€	🚚	📦
1	60	3	15,10	1	081760020
1,5	60	3	22,20	1	081760030
2	60	3	28,50	1	081760040
2,5	60	3	35,50	1	081760050
3	60	3	42,00	1	081760060
4	60	3	56,00	1	081760080
5	60	3	70,50	1	081760100
6	60	3	85,00	1	081760120
8	60	3	113,50	1	081760160

8177

lifting round slings, grey 4t
high-tenacity polyester (PES) belt

CE



UNI EN 1492-2

L m	H mm	WLL ton	€	🚚	📦
1	65	4	18,00	1	081770020
1,5	65	4	27,00	1	081770030
2	65	4	35,00	1	081770040
2,5	65	4	44,00	1	081770050
3	65	4	52,00	1	081770060
4	65	4	68,50	1	081770080
5	65	4	85,00	1	081770100
6	65	4	101,00	1	081770120
8	65	4	135,50	1	081770160

Robur

8178

lifting round slings, red 5t
high-tenacity polyester (PES) belt

CE

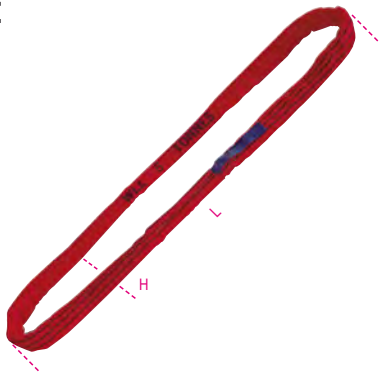

UNI EN 1492-2

L m	H mm	WLL ton	€	1	081780020
1	70	5	22,10	1	081780020
1,5	70	5	32,50	1	081780030
2	70	5	43,50	1	081780040
2,5	70	5	53,50	1	081780050
3	70	5	64,00	1	081780060
4	70	5	85,50	1	081780080
5	70	5	106,50	1	081780100
6	70	5	125,50	1	081780120
8	70	5	166,50	1	081780160

8179M

lifting round slings, brown 6t
high-tenacity polyester (PES) belt

CE

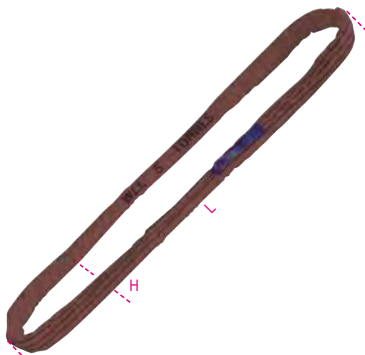

UNI EN 1492-2

L m	H mm	WLL ton	€	1	081790060
3	80	6	76,00	1	081790060
4	80	6	102,00	1	081790080
6	80	6	153,00	1	081790120
8	80	6	204,50	1	081790160

8179B

lifting round slings, blue, 8 t,
high-tenacity polyester (PES) belt

CE

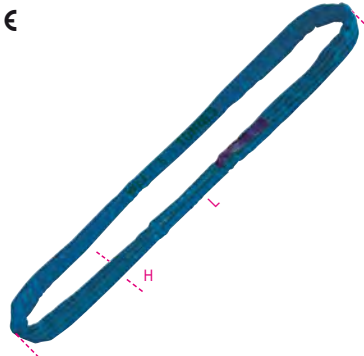

UNI EN 1492-2

L m	H mm	WLL ton	€	1	081790220
1	85	8	36,00	1	081790220
3	85	8	100,00	1	081790260
4	85	8	133,00	1	081790280
6	85	8	200,00	1	081790320
8	85	8	267,00	1	081790360

8179A

lifting round slings, orange, 10 t,
high-tenacity polyester (PES) belt

CE

UNI EN 1492-2



L m	H mm	WLL ton	€	1	081790502
1	95	10	47,00	1	081790502
2	95	10	93,00	1	081790504
3	95	10	143,00	1	081790506
4	95	10	189,00	1	081790508
6	95	10	284,00	1	081790512
8	95	10	360,00	1	081790516
10	95	10	471,00	1	081790520
2	100	12	150,50	1	081791204
2,5	100	12	178,00	1	081791205
3	100	12	205,50	1	081791206
3,5	100	12	232,50	1	081791207
4	100	12	260,00	1	081791208
4,5	100	12	263,00	1	081791209
5	100	12	314,00	1	081791210
5,5	100	12	342,00	1	081791211
6	100	12	369,00	1	081791212
6,5	100	12	396,00	1	081791213
7	100	12	424,00	1	081791214
7,5	100	12	451,00	1	081791215
8	100	12	478,00	1	081791216
8,5	100	12	506,00	1	081791217
9	100	12	533,00	1	081791218
9,5	100	12	560,00	1	081791219
10	100	12	587,00	1	081791220
2	110	15	212,00	1	081791504
2,5	110	15	247,50	1	081791505
3	110	15	283,00	1	081791506
3,5	110	15	319,00	1	081791507
4	110	15	355,00	1	081791508
4,5	110	15	390,00	1	081791509
5	110	15	426,00	1	081791510
5,5	110	15	462,00	1	081791511
6	110	15	497,00	1	081791512
6,5	110	15	533,00	1	081791513

L m	H mm	WLL ton	€	1	081791514
7	110	15	569,00	1	081791514
7,5	110	15	604,00	1	081791515
8	110	15	640,00	1	081791516
8,5	110	15	676,00	1	081791517
9	110	15	711,00	1	081791518
9,5	110	15	756,00	1	081791519
10	110	15	783,00	1	081791520
2	130	20	249,50	1	081792004
2,5	130	20	293,00	1	081792005
3	130	20	336,00	1	081792006
3,5	130	20	379,00	1	081792007
4	130	20	423,00	1	081792008
4,5	130	20	466,00	1	081792009
5	130	20	509,00	1	081792010
5,5	130	20	552,00	1	081792011
6	130	20	596,00	1	081792012
6,5	130	20	639,00	1	081792013
7	130	20	682,00	1	081792014
7,5	130	20	725,00	1	081792015
8	130	20	769,00	1	081792016
8,5	130	20	812,00	1	081792017
9	130	20	855,00	1	081792018
9,5	130	20	898,00	1	081792019
10	130	20	942,00	1	081792020
2	135	25	276,00	1	081792504
2,5	135	25	330,00	1	081792505
3	135	25	384,00	1	081792506
3,5	135	25	438,00	1	081792507
4	135	25	493,00	1	081792508
4,5	135	25	547,00	1	081792509
5	135	25	601,00	1	081792510
5,5	135	25	655,00	1	081792511
6	135	25	710,00	1	081792512
6,5	135	25	764,00	1	081792513
7	135	25	818,00	1	081792514
7,5	135	25	872,00	1	081792515
8	135	25	927,00	1	081792516
8,5	135	25	981,00	1	081792517
9	135	25	1.035,00	1	081792518
9,5	135	25	1.089,00	1	081792519
10	135	25	1.144,00	1	081792520
2	160	30	324,00	1	081793004
2,5	160	30	390,00	1	081793005
3	160	30	456,00	1	081793006
3,5	160	30	522,00	1	081793007
4	160	30	589,00	1	081793008
4,5	160	30	655,00	1	081793009
5	160	30	721,00	1	081793010
5,5	160	30	787,00	1	081793011
6	160	30	853,00	1	081793012
6,5	160	30	919,00	1	081793013
7	160	30	985,00	1	081793014
7,5	160	30	1.051,00	1	081793015
8	160	30	1.117,00	1	081793016
8,5	160	30	1.183,00	1	081793017
9	160	30	1.250,00	1	081793018
9,5	160	30	1.315,00	1	081793019
10	160	30	1.380,00	1	081793020
2	165	40	431,00	1	081794004
2,5	165	40	481,00	1	081794005
3	165	40	560,00	1	081794006
3,5	165	40	639,00	1	081794007
4	165	40	718,00	1	081794008
4,5	165	40	797,00	1	081794009
5	165	40	876,00	1	081794010
5,5	165	40	955,00	1	081794011
6	165	40	1.034,00	1	081794012
6,5	165	40	1.113,00	1	081794013
7	165	40	1.192,00	1	081794014
7,5	165	40	1.270,00	1	081794015
8	165	40	1.350,00	1	081794016
8,5	165	40	1.430,00	1	081794017
9	165	40	1.510,00	1	081794018
9,5	165	40	1.585,00	1	081794019
10	165	40	1.665,00	1	081794020
3	180	50	650,00	1	081795006
3,5	180	50	740,00	1	081795007
4	180	50	831,00	1	081795008
4,5	180	50	921,00	1	081795009
5	180	50	1.011,00	1	081795010
5,5	180	50	1.101,00	1	081795011
6	180	50	1.191,00	1	081795012
6,5	180	50	1.280,00	1	081795013
7	180	50	1.370,00	1	081795014
7,5	180	50	1.460,00	1	081795015
8	180	50	1.550,00	1	081795016
8,5	180	50	1.640,00	1	081795017
9	180	50	1.730,00	1	081795018
9,5	180	50	1.820,00	1	081795019
10	180	50	1.910,00	1	081795020

Robur

8166

anti-abrasion sheaths for slings, high-tenacity polyester (PES), with elastomer underlayer



H mm	ø mm	L m	€	📄	🖨️
70	45	3	24,40	1	081660073
80	52	3	28,50	1	081660083
110	70	3	34,50	1	081660103
155	100	3	72,50	1	081660153
170	110	3	80,00	1	081660170
235	150	4	218,00	1	081660235

H mm	📄	🖨️	🖨️
70	8150	8170-8173	081660073
80	8153	8176	081660083
110	8153-8156	8177-8178	081660103
155	8157	8178-8179A 8179B-8179M	081660153
170	8158	-	081660170
235	8159	-	081660235

8090F

lifting connecting links for polyester slings, alloy steel, painted

CE

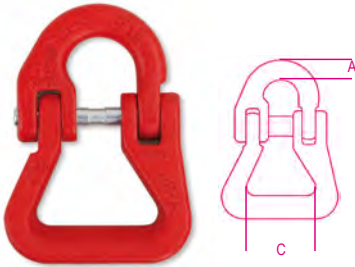

EN 1677-1

TECHNICAL DATA

- safety factor: 4
 - heat treatment: hardening and tempering
 - traceability code
- ### LABORATORY TESTS
- chemical analysis, metallographic analysis
 - proof load test (WLL x 2.5)
 - tensile test
 - fatigue test (min. 20,000 cycles)

AVAILABLE CERTIFICATES

- Technical product specifications
- Test report UNI EN10204 type 2.2
- Inspection certificate UNI EN10204 type 3.1
- CE Declaration of Conformity

WLL kg	📄	🖨️	🖨️	€	📄	🖨️
2000	7-8	10,5	40	30,00	1	080900220
3150	10	12	50	37,00	1	080900232
5300	13	17	60	57,50	1	080900253
8000	16	21	75	87,50	1	080900280

RATCHET TIE DOWNS

TECHNICAL DATA

- safety factor: 2
- traceability code

LABORATORY TESTS

- ratchet pretensioning test
- metal parts deformation test
- complete system tensile test

AVAILABLE CERTIFICATES

- Technical product specifications
- Test report UNI EN10204 type 2.2

8180

ratchet tie down with single hook, LC 750kg high-tenacity polyester (PES) belt

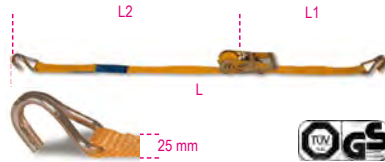

EN 12195-2

L m	L2 mm	L1 mm	€	📄	🖨️
4	3750	250	15,80	1	081800004
6	5750	250	18,20	1	081800006
8	7750	250	20,50	1	081800008

LC = 750 kg

8181

ratchet tie down with single hook, LC 1000kg high-tenacity polyester (PES) belt



EN 12195-2

L m	L2 mm	L1 mm	€	📄	🖨️
4	3600	400	19,30	1	081810004
6	5600	400	22,20	1	081810006
8	7600	400	24,40	1	081810008

LC = 1000 kg

8181S

ratchet tie down with double hook, LC 1000kg, high-tenacity polyester (PES) belt



EN 12195-2

L m	L2 mm	L1 mm	STF daN	€	📄	🖨️
6	5600	400	180	21,50	1	081810206

LC = 1000 kg

8182T

ratchet tie down with double hook, LC 1500kg, high-tenacity polyester (PES) belt

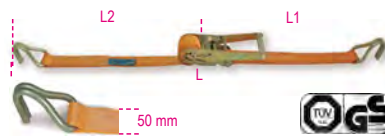

EN 12195-2

L m	L1 mm	L2 mm	€	📄	🖨️
8,5	400	8100	34,00	1	081821085
10,5	400	10100	37,50	1	081821105

LC = 1500 kg

8182

ratchet tie down with single hook, LC 2000kg high-tenacity polyester (PES) belt

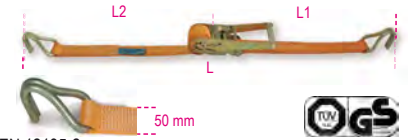

EN 12195-2

L m	L2 mm	L1 mm	€	📄	🖨️
4,5	4100	400	30,50	1	081820045
6,5	6100	400	36,00	1	081820065
8,5	8100	400	41,00	1	081820085
10,5	10100	400	45,00	1	081820105
14,5	14100	400	51,00	1	081820145
16,5	16100	400	57,00	1	081820165

LC = 2000 kg

	L2 mm	L1 mm	€	📄	🖨️
8182LP long part	8100		21,50	1	081820902
8182SP short part		400	22,20	1	081820905

8182H

ratchet tie down with single hook, LC 2500kg, high-tenacity polyester (PES) belt

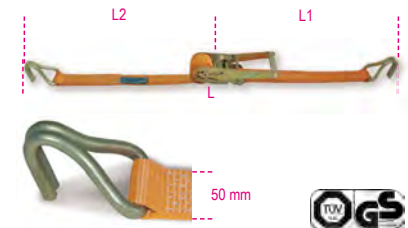

EN 12195-2

L m	L1 mm	L2 mm	€	📄	🖨️
6,5	400	6100	39,00	1	081820406
8,5	400	8100	43,00	1	081820408
10,5	400	10100	47,00	1	081820410
14,5	400	14100	60,00	1	081820414

LC = 2500 kg

8182TS

ratchet tie down with single hook, LC 1500kg, high-tenacity polyester (PES) belt

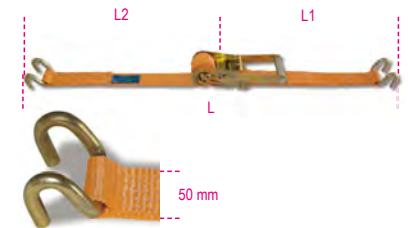

EN 12195-2

L m	L1 mm	L2 mm	€	📄	🖨️
8,5	400	8100	35,00	1	081821285
10,5	400	10100	39,00	1	081821305

LC = 1500 kg

8182S

ratchet tie down with double hook, LC 2000kg
high-tenacity polyester (PES) belt

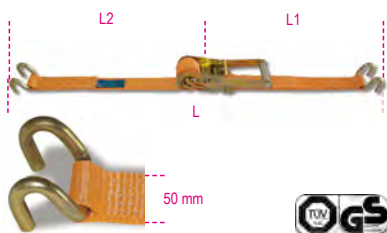

EN 12195-2

L m	L2 mm	L1 mm	€		
6,5	6100	400	35,50	1	081820265
8,5	8100	400	40,50	1	081820285
10,5	10100	400	45,00	1	081820305

LC = 2000 kg

	L2 mm	L1 mm	€		
8182SLP long part	8100		21,00	1	081820912
8182SSP short part		400	21,50	1	081820915

8184

reverse ratchet tie down, long lever, with single
hook, LC 2500 kg,
high-tenacity polyester (PES) belt



EN12195-2

L m	L2 mm	L1 mm	STF daN	€		
6,5	6100	400	500	36,00	1	081840065
8,5	8100	400	500	38,50	1	081840085
10,5	10100	400	500	42,00	1	081840105

LC = 2500 kg

8183

ratchet tie down with single hook, LC 5000 kg,
high-tenacity polyester (PES) belt



EN 12195-2

L m	L2 mm	L1 mm	STF daN	€		
8,5	8000	500	500	124,50	1	081830085
12,5	12000	500	500	148,00	1	081830125

LC = 5000 kg

8190

ratchet load binder with 2 hooks
Grade 8



EN12195/3

TECHNICAL DATA

- Safety factor: 2
 - Heat treatment: hardening and tempering
 - Traceability code
- AVAILABLE CERTIFICATES
- Technical product specifications
 - Test report UNI EN10204 type 2.2
 - Inspection certificate UNI EN10204 type 3.1

∅ mm	LC daN	∅ mm	LC daN	€		
10	6300	8	4000	86,50	1	081900010

* CAUTION: The product can be used with an 8-mm
chain, provided WLL is reduced (LC 4000 daN)

8190B

lashing chains



EN12195/3

TECHNICAL DATA

- Safety factor: 2 • Heat treatment: hardening tempering
 - Chain-sling identification tag
- ATTACHED CERTIFICATES
- Manufacturer's Certificate
- AVAILABLE CERTIFICATES
- Technical product specifications
 - Test report UNI EN 10204 type 2.2

∅ mm	LC daN	L m	L1 m	€		
8	4000	3,5	3,30	164,50	1	081901308
10	6300	3,5	3,28	248,50	1	081901310

8182A

ratchet tie downs with 2 eyes,
high-tenacity polyester (PES) belt,
LC 2000 kg



EN 12195-2

L m	L2 mm	L1 mm	STF daN	€		
8,5	8100	400	300	40,50	1	081820585

LC = 2000 kg

8182E

ratchet tie downs for van and truck interiors,
LC 1000 kg,
high-tenacity polyester (PES) belt



EN 12195-2

L m	L2 mm	L1 mm	STF daN	€		
4	3500	500	220	22,20	1	081820440

LC = 1000 kg

	L2 mm	L1 mm	€		
8182EL	2500		6,80	1	081820942
8182EC		1500	14,80	1	081820945

8185

ring ratchet tie down, LC 1500kg
high-tenacity polyester (PES) belt



EN 12195-2

L m	STF daN	€		
5	200	13,00	1	081850005
8	200	15,80	1	081850008

8186

ring ratchet tie down, LC 2000kg
high-tenacity polyester (PES) belt



EN 12195-2

L m	STF daN	€		
5	180	15,80	1	081860005
8	180	20,00	1	081860008

8187

ring ratchet tie down, LC 4000kg
high-tenacity polyester (PES) belt



EN 12195-2

L m	STF daN	€		
5	350	29,00	1	081870005
8	350	34,00	1	081870008

8188C

ring ratchet tie downs, LC 750 kg,
high-tenacity polyester (PES) belt



EN 12195-2

L m	STF daN	€		
1,5	72	4,95	3	081880315
5	72	7,40	3	081880350

8188CG/25

ratchet tie downs with S-hooks and Eyes,
LC 400 kg
high-tenacity polyester (PES) strap



EN 12195-2

L m	L1 mm	L2 mm	€		
3	480	170	11,00	1	081880430
5	480	170	11,90	1	081880450

8188CU/25

ratchet tie downs with single hooks,
LC 400 kg,
high-tenacity polyester belt (PES)



EN 12195-2

L m	L1 mm	L2 mm	€		
5	300	4700	11,40	1	081880750

8188F

cam buckle straps, LC 200 kg,
high-grade polypropylene (PP) belt

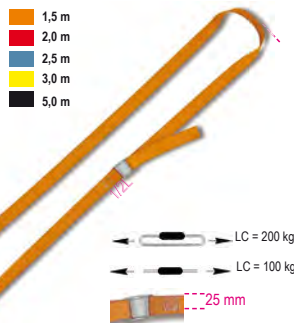

EN 12195-2

L m	€		
1,5	2,84	10	081880215
2,0	3,05	10	081880220
2,5	3,40	10	081880225
3,0	3,60	10	081880230
5,0	4,55	6	081880250

8188F35

cam buckle straps, LC 500 kg,
high-tenacity polypropylene (PP) belt

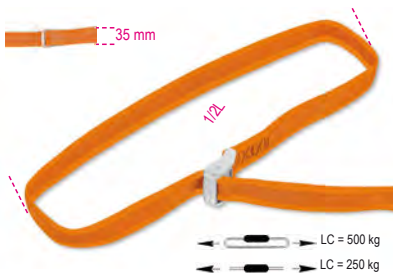

EN 12195-2

L m	€		
5	10,30	1	081880295

8188VFG2

cam buckle strap with S-hooks and Eyes,
LC 250 kg
high-grade polypropylene (PP) belt



EN 12195-2

L m	L1 mm	L2 mm	€		
3	450	110	14,60	1	081881530

8189

polyester belt (PES)
for ratchet tie downs



H mm	L m	LC kg	€		
25	100	750	105,50	1	081890902
35	100	1000	133,00	1	081890903
50	100	2000	213,00	1	081890905

8189A

non-slip mat
for fixing loads



L m	H mm	S mm	μ	€		
5	250	8	0,6	74,00	1	081890525

8189PA

2 angular guards
for polyester belts

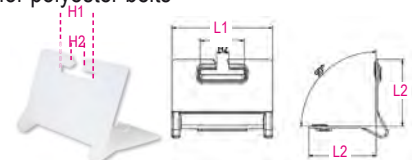

L1xL2 mm	H1 mm	H2 mm	€		
135x90	60	18	4,55	1	081890090

Item	Test Report 2.2 (UNI EN 10204)	Test Certificate 3.1(UNI EN 10204)	Manufacturer's Certificate	CE Declaration of Conformity
8001Z	✓	✓		✓
8001TZ	✓	✓		✓
8002ZD	✓			
8003ZD	✓			
8004ND	✓			
8005Z	✓			✓
8005TZ	✓			✓
8006Z	✓			✓
8007Z	✓			✓
8008N	✓			✓
8008TZN	✓			✓
8009FD	✓			
8009Z	✓			✓
8009TZ	✓			✓
8010Z	✓			✓
8010TZ	✓			
8015	✓		✓	✓
8016	✓			✓
8016DA	✓			✓
8016FR	✓			
8016U2	✓		✓	✓
8016UGK	✓		✓	✓
8018E	✓			
8018T	✓			
8020	✓			
8021	✓			
8025	✓	✓		✓
8026A	✓	✓		✓
8026R	✓	✓		✓
8028	✓	✓		✓
8029R	✓	✓		✓
8031R	✓	✓		✓
8032	✓	✓		✓
8040EN	✓	✓		✓
8040EZ	✓	✓		✓
8042EN	✓	✓		✓
8042EZ	✓	✓		✓
8041	✓	✓		✓
8043	✓	✓		✓
8044	✓	✓		✓
8048	✓			
8049	✓	✓		✓
8049A	✓	✓		✓
8049V	✓	✓		✓
8051S	✓	✓		✓
8052	✓	✓		✓
8057R	✓	✓		✓
8058R	✓	✓		✓
8060R	✓	✓		✓
8061R	✓	✓		✓
8062	✓	✓		✓
8063	✓	✓		✓
8063SL	✓	✓		✓
8064S	✓	✓		✓
8065SC	✓	✓		✓
8074	✓			
8074A	✓			
8074G	✓			
8080	✓			
8080FM	✓			
8085R	✓	✓		✓
8086	✓	✓		✓
8090	✓	✓		✓

Item	Test Report 2.2 (UNI EN 10204)	Test Certificate 3.1(UNI EN 10204)	Manufacturer's Certificate	CE Declaration of Conformity
8090F	✓	✓		✓
8090R	✓	✓		✓
8091			✓	✓
8091SL			✓	✓
8092			✓	✓
8092SL			✓	✓
8094			✓	✓
8094SL			✓	✓
8096			✓	✓
8096SL			✓	✓
8097			✓	✓
8097SL			✓	✓
8098			✓	✓
8098SL			✓	✓
8100	✓	✓		✓
8105	✓	✓		✓
8109	✓	✓		✓
8110	✓			
8114	✓			
8116	✓			
8120 - 8120D	✓			
8120B	✓			
8130A	✓			
8135	✓		✓	✓
8139DL	✓			
8143	✓		✓	✓
8146	✓		✓	✓
8146K	✓		✓	✓
8150	✓		✓	✓
8153	✓		✓	✓
8156	✓		✓	✓
8157	✓		✓	✓
8158	✓		✓	✓
8159	✓		✓	✓
8160	✓		✓	✓
8161	✓		✓	✓
8166	✓			
8170	✓		✓	✓
8173	✓		✓	✓
8176	✓		✓	✓
8177	✓		✓	✓
8178	✓		✓	✓
8179M-B-A	✓		✓	✓
8180	✓			
8181	✓			
8181S	✓			
8182	✓			
8182A	✓			
8182E	✓			
8182H	✓			
8182M	✓			
8182S	✓			
8182T	✓			
8182T-TS	✓			
8182TS	✓			
8185	✓			
8186	✓			
8187	✓			
8188C	✓			
8188CG/25	✓			
8188CU	✓			
8188F	✓			
8188VF/35	✓			

Item	Test Report 2.2 (UNI EN 10204)	Test Certificate 3.1(UNI EN 10204)	Manufacturer's Certificate	CE Declaration of Conformity
8188FG2	✓			
8190	✓	✓		
8190B	✓		✓	
8302Z	✓			
8303Z	✓			
8317DZ	✓			
8317SZ	✓			
8381SL	✓			
8381SP	✓			
8383C	✓			
8383P	✓			
8515V	✓			
8515Z	✓			
8531	✓			
8532	✓			
8535	✓			
8201T	✓			
8205	✓			
8206	✓			
8207	✓			
8209	✓			
8210	✓			
8210F	✓			
8216	✓			✓
8220	✓			
8225	✓			
8227	✓			
8228	✓			
8240	✓			
8240F	✓	✓		✓
8242	✓			
8242F	✓	✓		✓
8248	✓			
8249	✓			
8249G	✓			
8250	✓			
8264	✓			
8267	✓			
8272	✓			
8273	✓			
8274	✓			
8274A	✓			
8274G	✓			
8276	✓			
8276G	✓			
8278	✓			
8280	✓			
8282	✓			
8282S	✓			
8284	✓			
8285	✓			
8286	✓			
8287	✓			
8290	✓			
8293	✓			
8297C	✓			
8297F	✓			
8381SX	✓			
8702...	✓	✓		
8709...	✓	✓		



Beta Collection



A range of exclusive products designed and developed to epitomize Beta's character, it comprises over 200 original, first-rate items: sports equipment, technical clothing and a variety of tailored objects. An ideal medium for promotional actions, a must for recreational moments.



9500TL

softshell jacket, made of 100% polyester, 320 g/m², three-layered, microfibre outer shell, waterproof, breathable intermediate membrane, fleece interior



	€	📦	🖨️
S	170,00	1	095000051
M	170,00	1	095000052
L	170,00	1	095000053
XL	170,00	1	095000054
XXL	170,00	1	095000055

9501TLD

women's sweatshirt, made of cotton (80%) and polyester (20%), 320 g/m²



	€	📦	🖨️
S	83,00	1	095010061
M	83,00	1	095010062
L	83,00	1	095010063
XL	83,00	1	095010064

9501TL

men's sweatshirt, made of cotton (80%) and polyester (20%), 320 g/m²



	€	📦	🖨️
S	97,00	1	095010051
M	97,00	1	095010052
L	97,00	1	095010053
XL	97,00	1	095010054
XXL	97,00	1	095010055

9502TL

polo shirt, 100% pique cotton, 210 g/m²



	€		
S	57,00	1	095020051
M	57,00	1	095020052
L	57,00	1	095020053
XL	57,00	1	095020054
XXL	57,00	1	095020055

9503TL

t-shirt, 100% jersey cotton, 160 g/m²



	€		
S	37,00	1	095030051
M	37,00	1	095030052
L	37,00	1	095030053
XL	37,00	1	095030054
XXL	37,00	1	095030055

9504TL

jacket with 100% polyester exterior, waterproof treatment



	€		
S	115,50	1	095040051
M	115,50	1	095040052
L	115,50	1	095040053
XL	115,50	1	095040054
XXL	115,50	1	095040055

9505TL

sleeveless jacket with 100% polyester exterior, waterproof treatment, padding 100 g/m², interior pocket



	€		
S	142,00	1	095050051
M	142,00	1	095050052
L	142,00	1	095050053
XL	142,00	1	095050054
XXL	142,00	1	095050055

9572LB

Beta-March t-shirt, 100% cotton, 200 g/m² orange, with black inserts



	€		
S	45,00	1	095720801
M	45,00	1	095720802
L	45,00	1	095720803
XL	45,00	1	095720804
XXL	45,00	1	095720805

9508TL

waterproof jacket, 100% polyester, folds into pocket



	€		
S	96,00	1	095080051
M	96,00	1	095080052
L	96,00	1	095080053
XL	96,00	1	095080054
XXL	96,00	1	095080055

9510W

men's stretch shirt, long-sleeved, 120 g/m², 97% cotton, 3% elastane. White, with black logo. Rear yoke with two side pleats, semi-French collar. White buttons, two cuff buttons. Slim fit



	€		
XS	104,00	1	095100100
S	104,00	1	095100101
M	104,00	1	095100102
L	104,00	1	095100103
XL	104,00	1	095100104
XXL	104,00	1	095100105

9534W0

two-button polo shirt, made of jersey cotton, 200 g/m², white with orange inserts



	€		
S	59,00	1	095340031
M	59,00	1	095340032
L	59,00	1	095340033
XL	59,00	1	095340034
XXL	59,00	1	095340035

9534B0

two-button polo shirt, made of jersey cotton, 200 g/m², blue with grey inserts



	€		
S	59,00	1	095340071
M	59,00	1	095340072
L	59,00	1	095340073
XL	59,00	1	095340074
XXL	59,00	1	095340075

9537TL

fleece pullover, 100% polyester



	€		
S	56,00	1	095370051
M	56,00	1	095370052
L	56,00	1	095370053
XL	56,00	1	095370054
XXL	56,00	1	095370055

9580S

sunglasses "Summer" style

CE



EN ISO 12312-1:2013+A1:2015
UV400
FILTER CAT. III

	€		
9580S	31,50	1	095800100

9593S

smartwatch, touchscreen, fitness tracker, silicone strap



	€		
9593S	135,00	1	095930200

9593SB

multifunction smart bracelet, touchscreen, fitness tracker, heart rate monitor, pedometer, sleep monitoring, with silicone strap, black

Compatibility: IOS 8.2 or above/ Android 4.4 or above
Bluetooth 4.2
IP67

CE



IP67

	€		
9593SB	99,50	1	095930205

9593M

automatic watch, steel case, 5 ATM water resistant, steel wristband



	€		
9593M	329,00	1	095930120

9593A

chronograph, steel case, 5 ATM water resistant, silicone strap



	€		
9593A	260,00	1	095930050

9593W

analogue watch, soft touch plastic case with metal ring, 3 ATM water resistant, silicone strap



	€		
9593W	57,00	1	095930150

9544C

cabin-size trolley with 4 double wheels, TSA lock, USB port + 3.5-mm jack



	€		
9544C	135,50	1	095440101

9557J 2.0

bag made of coated polyester/Oxford 600D polyester fabric, dimensions 47x28x25 cm



	€		
9557J 2.0	80,50	1	095570020

9557J 3.0

bag made of coated polyester/Oxford 600D, dimensions 58x29x36 cm



	€		
9557J 3.0	98,50	1	095570030

Beta

Beta

9557N

"Racing" bag, made from waterproof PVC coated fabric



cm
80x35x35 € 104,50 1 095570001

9541F

rucksack made of coated polyester/Oxford 600D polyester fabric, dimensions 50x33x16 cm



9541F € 76,00 1 095410011

9541S

Rucksack with casing, made of waterproof 210D polyester, 33x45 cm



9541S € 10,30 1 095410031

9541BIKE

rucksack made of Oxford polyester, dimensions 41x24x16 cm



9541BIKE € 18,00 1 095410021

95740

work gloves, with stretch-elastic cuffs, reinforced thumbs and index fingers, made from touchscreen capable synthetic leather



	€		
M	35,00	1	095740202
L	35,00	1	095740203
XL	35,00	1	095740204
XXL	35,00	1	095740205

9574B

work gloves, with stretch-elastic cuffs, reinforced thumbs and index fingers, made from touchscreen capable synthetic leather



	€		
M	35,00	1	095740102
L	35,00	1	095740103
XL	35,00	1	095740104
XXL	35,00	1	095740105

9525TL

Top Line cap



9525TL € 26,00 1 095250010

9525F

flat visor cap



9525F € 26,00 1 095250099

9525/B

cap, 100% cotton, one size-fits-all adjustable buckle strap, directly embroidered front, sides and back, white



9525B € 15,30 5 095251031

9521

umbrella, made of nylon T210, 3-section aluminium frame, black, automatic open/close mechanism



9521 € 28,50 1 095210000

95210B

umbrella made of nylon 210T, diameter 100 cm



95210B € 32,00 1 095210021

9599CB-N2

Atala® city bike, Hi-Ten Tig TKK 700c frame, Shimano® Tourney RD-TZ50 derailleur, 6-speed, V-Brakes®, 28" aluminium rims, with pannier rack, stand and bell, matt black



9599CB-N2 € 600,00 1 095990031

9599CB-W

Atala® city bike, aluminium frame, Shimano® 6-speed gear, V-Brakes® 28" aluminium rims



9599CB-W € 600,00 1 095990023

9598W-N

Whistle® mountain bike, aluminium frame, Suntour XCT30 fork, 29" 100 mm, Shimano RD-TX500 derailleur, 7-speed, hydraulic Shimano BR-M200 brakes and 29" aluminium rims, fluorescent orange / matt anthracite grey



	€	🛒	📄
9598W-N M	1.024,00	1	095980130
9598W-N L	1.024,00	1	095980132

9598WHP-N

Whistle® mountain bike, aluminium frame, Suntour XCM PL fork, 29" 100 mm, with remote lockout, Shimano XT RD-M8100 Shadow Plus derailleur, 12-speed, hydraulic Shimano BL-MT201/BR-MT200 brakes and 29" aluminium rims, white / matt red



	€	🛒	📄
9598WHP-N M	1.920,00	1	095980140
9598WHP-N L	1.920,00	1	095980142

9515M

technical jersey, made from quick-dry, breathable fabric; side mesh inserts



	€	🛒	📄
S	74,00	1	095150051
M	74,00	1	095150052
L	74,00	1	095150053
XL	74,00	1	095150054
XXL	74,00	1	095150055
XXXL	74,00	1	095150056

9516B

shorts made from quick-dry, breathable Lycra, 180 g/m², with elastic waistband for improved fit



	€	🛒	📄
S	85,00	1	095160051
M	85,00	1	095160052
L	85,00	1	095160053
XL	85,00	1	095160054
XXL	85,00	1	095160055
XXXL	85,00	1	095160056

9539CB

protective road and mountain bike cycling helmet with detachable chin guard - adjustable sizes



	€	🛒	📄
S-M	158,00	1	095390010
L-XL	158,00	1	095390011

9542M

short-sleeved jersey, breathable microfibre fabric, long, covered zip, three rear pockets, including one with zip, silicone elastic at jersey end



	€	🛒	📄
S	113,00	1	095420051
M	113,00	1	095420052
L	113,00	1	095420053
XL	113,00	1	095420054
XXL	113,00	1	095420055
XXXL	113,00	1	095420056

9542C

Lycra bib shorts, silicone elastic at leg end, antibacterial seat padding



	€	🛒	📄
S	107,50	1	095420061
M	107,50	1	095420062
L	107,50	1	095420063
XL	107,50	1	095420064
XXL	107,50	1	095420065
XXXL	107,50	1	095420066

9542GW

winter jacket, made from highly breathable, winder breaker fabric and raised fabric; long zip, silicone-free elastic waistband; close-fitting Lycra cuffs; refractive rear inserts; 3 exterior rear pockets, including 1 with zip



	€	🛒	📄
S	195,50	1	095420101
M	195,50	1	095420102
L	195,50	1	095420103
XL	195,50	1	095420104
XXL	195,50	1	095420105
XXXL	195,50	1	095420106

Beta
Quality Tools

Beta

9542G

winter jersey, breathable fabric, raised inside, long zip, three rear pockets, silicone elastic at jersey end



SIZE	€	🛒	📄
S	112,50	1	095420012
M	112,50	1	095420013
L	112,50	1	095420014
XL	112,50	1	095420015
XXL	112,50	1	095420016
XXXL	112,50	1	095420017

9542S

winter underpants, raised Lycra, antibacterial, high-breathability seat padding



SIZE	€	🛒	📄
S	151,00	1	095420022
M	151,00	1	095420023
L	151,00	1	095420024
XL	151,00	1	095420025
XXL	151,00	1	095420026
XXXL	151,00	1	095420027

Beta

9542AT

sleeveless wind stopper jacket, breathable bound fabric, long zip



SIZE	€	🛒	📄
S	91,00	1	095420072
M	91,00	1	095420073
L	91,00	1	095420074
XL	91,00	1	095420075
XXL	91,00	1	095420076
XXXL	91,00	1	095420077

9542AL

waterproof windbreaker, long-sleeved, made of breathable fabric



SIZE	€	🛒	📄
S	145,00	1	095420042
M	145,00	1	095420043
L	145,00	1	095420044
XL	145,00	1	095420045
XXL	145,00	1	095420046
XXXL	145,00	1	095420047

9543C

tubular neck scarf, multipurpose, 100% polyester microfibre, seamless



SIZE	cm	€	🛒	📄
9543C	25x50	7,90	1	095430100

9523T

thermal bottle, made of stainless steel, 500 ml, double-layer technology, no air between walls, leak-proof cap, orange

- keeps cold drinks cold for 24 hours
- keeps hot drinks hot for 12 hours

CE



EC1935/EC2023

SIZE	ml	L	mm	€	🛒	📄
9523T	500	255		19,90	1	095230050

9528B

Polyethylene flask, 500 ml



SIZE	€	🛒	📄
9528B	6,25	1	095280005

9597P

column pump with gauge



SIZE	€	🛒	📄
9597P	58,00	1	095970100

9524SC

miniature Beta garage for collectors



SIZE	€	🛒	📄
1:18	83,00	1	095240018

Beta

9548KB

balance bike, aluminium frame, 12" wheel with inner tube; recommended for children from 3 years; maximum weight: 30 kg



9548KB € 150,00 1 095480110

9548KB 20

Atala® 20" children's mountain bike, Hi-Ten Tig 20" steel frame, 30-mm suspension fork, RD-TY21SS 6V derailleur, aluminium V-brakes and 36-hole aluminium rims, fluorescent yellow / matt blue



9548KB 20 € 485,00 1 095480120

9548KB 24

Atala® 24" children's mountain bike, Hi-Ten Tig 24" steel frame, suspension fork, Shimano Tourney RD-TYZ50 6V derailleur, aluminium V-brakes and 36-hole aluminium rims, matt fluorescent orange



9548KB 24 € 516,00 1 095480122

9547WSK

"Kinder Work Station", workbench with tools, for children from 3 years of age



74 cm

9547WSK € 112,50 1 095473801

9547T

"Kinder trolley", tool trolley, for children from 3 years of age, complete with tools



9547T € 61,00 1 095470100

9548G

"Kinder Garage", 6-storey, with car wash, lift and ramps



69 cm

9548G € 61,00 1 095480100

9561V 2,5

sail flag 2.5x0.50 m with aluminium pole, cross base with weighted ring



9561V 2,5 € 221,00 1 095610200

9561VV 2,5

sail flag, 2x0.50 m, with pole



9561VV 2,5 € 170,00 1 095610201

9561VV

sail flag, 3.50x0.75 m, with pole



9561VV € 245,50 1 095610101

9561V

sail flag, 4x0.75 m, with chrome-plated metal pole, grit concrete base, 50 cm



9561V € 403,00 1 095610001

9559

one-sided banner, TNT; modules: 3x0.8 m



9559 € 26,50 1 095591001

9559/30MT

nonwoven fabric roll of 10 Beta logos



9559/30MT € 249,50 1 095591031

9590B

flag, made of screen-printed nylon



9590B € 112,50 1 095900000

9577M

overalls, T/C twill, polyester/cotton (65/35), 240 g/m²



SIZE	€	QTY	SKU
S	134,00	1	095770051
M	134,00	1	095770052
L	134,00	1	095770053
XL	134,00	1	095770054

9579C

work jacket, polyester/cotton



SIZE	€	QTY	SKU
M	59,00	1	095791002
L	59,00	1	095791003
XL	59,00	1	095791004

9565BBQ

sheet steel barbecue drum with grill, brazier and lid complete with locking clamp

Chromium-plated steel grill (compliant with Italian Ministerial Decree of 21/03/73 and Regulation (EC) 1935/2004 on food contact materials), with handles and feet



SKU	€	QTY	SKU
9565BBQ	523,00	1	095650100

h 88 cm - ø 59 cm

9565T

sheet steel table drum with varnished multi-ply birch top

Supplied with a double KIT of spacing tubes (7 cm or 20 cm) for vertical adjustment.



SKU	€	QTY	SKU
9565T	442,00	1	095650200

h 95→108 cm - ø 70 cm

9565S

sheet steel drum with seat made of removable imitation leather



SKU	€	QTY	SKU
9565S	193,00	2	095650300

h 60 cm - ø 38 cm

9565ICE

sheet steel ice drum with lid and non-scratch container, certified for food use

Interior of drum is coated with antirust, water-resistant paint. Storage container can accommodate ice and bottles/cans to cool.



SKU	€	QTY	SKU
9565ICE	204,50	1	095650400

h 60 cm - ø 38 cm

9565K

drum table with two seats



SKU	€	QTY	SKU
9565K	828,00	1	095650500

9563G

office armchairs, for guests



SKU	€	QTY	SKU
9563G	164,50	1	095630050

9563U

office armchair, ergonomic



SKU	€	QTY	SKU
9563U	324,00	1	095630020

Beta
Quality Tools

9549ABW

wireless Bluetooth V5.0 earphones, with built-in microphone, magnetic charging, USB-C charging base, black

CE



	L	H	S	€		
	mm	mm	mm			
9549ABW	61	34,5	41	29,50	1	095490091

9549BP

portable battery, 10000mAh



9549BP	€		
	21,00	1	095490052

9549C

USB key, 32 GB



9549C	€		
	18,60	1	095490062

9547

desk calculator



9547	€		
	18,70	1	095470000

9594

clock complete with thermometer and hygrometer, 26 cm in diameter



∅	cm	€		
26		28,00	1	095940051

9526P

capsule espresso coffee machine. (capsules not included)
Compatible with Lavazza™ and Espresso Point™ capsules for professional use



9526P	€		
	317,00	1	095260010

9527 6T

set of 6 coffee cups



9527 6T	€		
	91,00	1	095270001

9527MUG

mug with cover and silicone sleeve



9527MUG	€		
	23,90	1	095270020

9522A

bottle opener with ergonomic handle



9522A	€		
	15,80	1	095220010

9523A

aluminium flask, 500 ml



9523A	€		
	10,90	1	095230005

9586K

multipurpose steel knife, 10 functions



9586K	€		
	15,30	1	095860100

9526RMN

set of 2 packs of 55 rummy playing cards by Modiano®



9526RMN	€		
	26,50	1	095260001

9592B/C50

set of 50 pens



9592B/C50	€		
	45,50	1	095920050

9592B/P

customised pens



9592B/P	€		
	1,36	500	095920051

9592MB

Parker® ballpoint pen



9592MB	€		
	74,00	1	095920060

9592M/50

set of 50 pencils



9592M/50	€		
	45,50	1	095920100

9588M

soft foam tray with 1 pen and 2 notebooks



9588M € 19,60 1 095880011

9596

badge holder, polyester, with metal clip and mobile phone string



9596 € 4,55 10 095961001

9595C

leather key ring



9595C € 8,30 1 095950011

9595T

metal chrome-plated key ring, in velvet pouch



9595T € 6,95 1 095950021

9595 C25

metal chrome-plated key ring with rubber hook



9595 C25 € 8,65 1 095950031

9569P

shopper, made of polyethylene, folded sides



9569P 44x34 € 0,73 50 095691001

9569S

TNT shopper with folded sides, 38x42 cm



9569S cm 38x42 € 2,27 50 095690051

9569MS-2

shopper, made of hard-wearing polypropylene



9569MS-2 cm 45x40 € 6,00 5 095690055

9569MS

shopper, made of hard-wearing polypropylene, with double handles



9569MS cm 60x40 € 6,00 5 095690052

9587 9x14

notebook, 9x14 cm



9587 9X14 € 12,30 5 095870009

9587 13x21

notebook, 13x21 cm



9587 13X21 € 15,70 5 095870013

9588S/10...

set of 10 notepads



9588S/10A	21x29 cm	€ 26,50	1	095881001
9588S/10B	15x21 cm	€ 25,50	1	095881002
9588S/10C	10x15 cm	€ 16,40	1	095881003
9588S/10D	7,5x10,5 cm	€ 11,80	1	095880054

Beta

9588/10PI

set of 10 notepads with adhesive sheets



9588S/10PI € 24,90 1 095880055
7,5x7,5 cm

9589A/36

pack of 36 rolls of packaging adhesive tape, with Beta logo, tawny



9589A/36 € 126,50 1 095890035

9589B/36

pack of 36 rolls of packaging adhesive tape, with Beta logo, white



9589B/36 € 126,50 1 095890036

9562TB

mat for trying on shoes, with anti-skid, rubber-coated bottom



9562TB € 44,00 1 095620500

9562T2

workbench mat, 200x160 cm

- protects floor from oil and petrol leaks, environmentally friendly
- easy to clean, anti-skid, rubber-coated bottom



9562T2 € 218,00 1 095620200

9562T1

garage mat, 100X80 cm

- particularly suitable for use under motorcycle tyre levers BETA 3071 and 3071B
- easy to clean, anti-skid rubber coated bottom

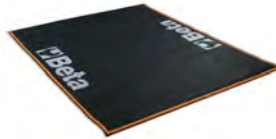

9562T1 € 80,00 1 095620150

9562T3

garage mat, 300x160 cm

- particularly suitable for use under motorcycle jacks
- protects floor from oil and petrol leaks, environmentally friendly
- easy to clean, anti-skid, rubber-coated bottom



9562T3 € 317,00 1 095620300

9562P2

multilogo mat, 200x80 cm

- particularly suitable for use with workshop equipment item C55 or under motorcycles



9562P2 € 153,00 1 095620400

9562P12

multilogo mat roll, 12 m x 80 cm

Allows mat length to be customized as needed



9562P12 € 772,00 1 095620425



ELIMINATED ITEMS - SUBSTITUTE/RECOMMENDED ITEMS

	ELIMINATED ITEM
	SUBSTITUTE ITEM
	RECOMMENDED ITEM

31/B6	000310020	31/B6N	000310024
31/B6-LSE	000310320	31/B6N-LSE	000310324
38/B6	000380006	38/B6N	000380016
42 5,5	000420005	42 5,5	000421005
42 6	000420006	42 6	000421006
42 7	000420007	42 7	000421007
42 8	000420008	42 8	000421008
42 9	000420009	42 9	000421009
42 10	000420010	42 10	000421010
42 11	000420011	42 11	000421011
42 12	000420012	42 12	000421012
42 13	000420013	42 13	000421013
42 14	000420014	42 14	000421014
42 15	000420015	42 15	000421015
42 16	000420016	42 16	000421016
42 17	000420017	42 17	000421017
42 18	000420018	42 18	000421018
42 19	000420019	42 19	000421019
42 20	000420020	42 20	000421020
42 21	000420021	42 21	000421021
42 22	000420022	42 22	000421022
42 23	000420023	42 23	000421023
42 24	000420024	42 24	000421024
42 25	000420025	42 25	000421025
42 26	000420026	42 26	000421026
42 27	000420027	42 27	000421027
42 28	000420028	42 28	000421028
42 29	000420029	42 29	000421029
42 30	000420030	42 30	000421030
42 32	000420032	42 32	000421032
42 34	000420034	42 34	000421034
42 35	000420035	42 35	000421035
42 36	000420036	42 36	000421036
42 38	000420038	42 38	000421038
42 41	000420041	42 41	000421041
42/BV6	000420051	2002/BV6	020020000
42/BV9	000420056	2002/BV9	020020030
42/SCV9I	000420103		
42/SCV9E	000420104		
42AS/B9	000420155	42AS/B9N	000420159
42SLIM/B8I	000420468	42SLIM/B8NI	000420478
42SLIM/B8E	000420469	42SLIM/B8NE	000420479
42MP/B9	000420651	42MP/B9N	000420661
42/B9	000421064	42/B9N	000421074
55/BV6	000550151	2002/BV6	020020000
55/B8	000550158	55/B8N	000550160
55/BV8	000550159	2002/BV8	020020020
55/B12	000550162	55/B12N	000550164
55/BV12	000550163	2002/BV12	020020040
73/B13	000730200	73/B13N	000730202
73/BV	000730201	2002/BV13	020020050
90/B8	000900154	90/B8N	000900156

90/BV8	000900155	2002/BV8	020020020
120/B6	001200050	120/B6N	001200060
120/BV	001200051	2002/BVL6	020020010
331L	003310008	334	003340001
331LR/L	003310058		
562/1	005620001	562-1/VA	005620601
562/2	005620002	562-2/VA	005620602
564/3R	005640003	564-3R/VA	005640603
564/4R	005640004	564-4R/VA	005640604
565/1R	005650011	565-1R/VA	005650611
565/2R	005650012	565-2R/VA	005650612
565/3R	005650013	565-3R/VA	005650613
565/4R	005650014	565-4R/VA	005650614
565/5R	005650015	565-5R/VA	005650615
567/4R	005670014	567-4R/VA	005670614
567/5R	005670015	567-5R/VA	005670615
900/C39	009000937		
960BT 25	009600125	960BC 25	009600285
960BT 27	009600127	960BC 27	009600287
960BT 29	009600129	960BC 29	009600289
960BT 30	009600130	960BC 30	009600290
971TSP	009710025		
999/B6	009990050	999/B6N	009990060
1105T 30	011050201	1105T 30	011050205
1105T 50	011050202	1105T 50	011050207
1105C/15T	011050251	1105C/16T	011050255
1105C/29T	011050252	1105C/32T	011050257
1128BCX	011280080		
1136 165	011360001		
1272MQ/F 1X4,5X80	012720409	1272MQF 1X4,5X80	012720609
1272MQ/F 2X6X100	012720418	1272MQF 2X6X100	012720618
1273MQ/E2	012730313	1273MQ/E4	012730315
1273MQ/F-D6	012730406	1273MQF/D6	012730606
1273BG-MQ/DV2	012730653	1273BG-MQ/DV4	012730655
1274MQ/F 3,5X100	012740403	1274MQF 3,5X100	012740603
1274MQ/F 4,5X100	012740406	1274MQF 4,5X100	012740606
1274MQ/F 5,5X125	012740409	1274MQF 5,5X125	012740609
1274MQ/F 6,5X150	012740412	1274MQF 6,5X150	012740612
1281/BV	012810501	2002/BV7-ZIP	020020060
1281BG/B28A	012810510	1281BG/B28NA	012810511
1438SAC	014380050		
1456/C8	014560010		
1461/C26B	014610227		
1497CEL	014970170		
1498/50A	014980050		
1498/30A	014980130		
1498C/24	014980244		
1560/1	015600001		
1712E/L1	017120111		
1712E/R-L1	017120611		

1843BM	018430101	1842 15-H05/LED	018420821
1843R/BM	018430131		
1846LED/BM	018460301	1842 15-H05/LED	018420821
1846LED/ABM	018460311	1842 15-H05/LED	018420821
1848	018480015	1844 15-H05/SCK	018440316
1850B	018500011	1850D	018500018
1850C	018500015	1850E	018500020
1850UB	018500100		
1850UF	018500101		
1850UP	018500102		
1850UR	018500103		
1860 140A	018600004	1860 160A	018600006
1871M	018710035		
1871M/AS	018710135		
1897KSA	018970660		
1901BM/8	019010111	1900S 8X10	019000080
1901T/10	019010210	1900M 10X15	019000115
1910/8	019100008	1900S 8X10	019000080
1910/10	019100010	1900M 10X15	019000115
1937RT	019370021		
1937RT/R	019370022		
1937RT/T	019370023		
1949GPE	019490008	1949GPA	019490018
1949DGT	019490020	1949DGT/2	019490021
2033P/VV	020330300	2033L/VV	020330250
2033PEL/A	020331214	2033LEL/A	020331224
2033PEL/B	020331215	2033LEL/B	020331225
2033PET/B	020331227	2033LET/B	020331237
C22S-O	022000501	RSC22-O	022003001
C22S-G	022000502	RSC22-A	022003007
C22S-R	022000503	RSC22-R	022003003
C23S-O	023000501	RSC23-O	023003001
C23S-G	023000502	RSC23-A	023003007
C23S-R	023000503	RSC23-R	023003003
C23SC-O	023000511	RSC23C-O	023003011
C23SC-G	023000512	RSC23C-A	023003017
C23SC-R	023000513	RSC23C-R	023003013
C23ST-O	023000521	RSC23T-FO	023003020
C23ST-G	023000522	RSC23T-A	023003027
C23ST-R	023000523	RSC23T-R	023003023
C24S/5-O	024002051	RSC24/5-FO	024004050
C24S/5-G	024002052	RSC24/5-A	024004057
C24S/5-R	024002053	RSC24/5-R	024004053
C24S/6-O	024002061	RSC24/6-FO	024004060
C24S/6-G	024002062	RSC24/6-A	024004067
C24S/6-R	024002063	RSC24/6-R	024004063
C24S/7-O	024002071	RSC24/7-FO	024004070
C24S/7-G	024002072	RSC24/7-A	024004077
C24S/7-R	024002073	RSC24/7-R	024004073
C24S/7-B	024002076	RSC24/7-B	024004076
C24S/7-N	024002079	RSC24/7-N	024004079
C24S/8-O	024002081	RSC24/8-FO	024004080
C24S/8-G	024002082	RSC24/8-A	024004087
C24S/8-R	024002083	RSC24/8-R	024004083
C24SL-O	024002101	RSC24L/7-O	024004371
C24SL-G	024002102	RSC24L/7-A	024004377

ELIMINATED ITEMS - SUBSTITUTE/RECOMMENDED ITEMS

	ELIMINATED ITEM
	SUBSTITUTE ITEM
	RECOMMENDED ITEM

C24SL-R	024002103	RSC24L7-R	024004373
C24SA/6-O	024002161	RSC24A/6-O	024004161
C24SA/6-G	024002162	RSC24A/6-A	024004167
C24SA/6-R	024002163	RSC24A/6-R	024004163
C24SA/7-O	024002171	RSC24A/7-O	024004171
C24SA/7-G	024002172	RSC24A/7-A	024004177
C24SA/7-R	024002173	RSC24A/7-R	024004173
C24SA/8-O	024002181	RSC24A/8-O	024004181
C24SA/8-G	024002182	RSC24A/8-A	024004187
C24SA/8-R	024002183	RSC24A/8-R	024004183
C24SL-CAB/O	024002191	RSC24L-CAB/O	024004471
C24SL-CAB/G	024002192	RSC24L-CAB/A	024004477
C24SL-CAB/R	024002193	RSC24L-CAB/R	024004473
C24SAXL/7-O	024002271	RSC24AXL/7-O	024004271
C24SAXL/7-G	024002272	RSC24AXL/7-A	024004277
C24SAXL/7-R	024002273	RSC24AXL/7-R	024004273
C24SAXL/8-O	024002281	RSC24AXL/8-O	024004281
C24SAXL/8-G	024002282	RSC24AXL/8-A	024004287
C24SAXL/8-R	024002283	RSC24AXL/8-R	024004283
C24SAXL/9-O	024002331	RSC24AXL/9-O	024004291
C24SAXL/9-G	024002332	RSC24AXL/9-A	024004297
C24SAXL/9-R	024002333	RSC24AXL/9-R	024004293
2400S/PF	024002906	2400 RSC24/PF-A	024004905
2400SR/PC-O	024002951		
2400SR/PC-G	024002952	2400 RSC24/PC-A	024004903
2400SR/PC-R	024002953		
M223	024500223	M222	024500222
M224	024500224		
C28-O	028000301	RSC28-O	028003001
C28-G	028000302	RSC28-A	028003007
C28-R	028000303	RSC28-R	028003003
C30S	030000100	C30M	030000300
3000S/PLM	030000150	3000M/PLM	030000350
3500/D	035000503		
3912T	039120010	3912TP	039120050
3912T/AD12	039120012		
3912T/AD15	039120015		
3912T/AD20	039120020		
3912T/ADC	039120035		
3912P	039120110	3912PP	039120150
3916MM	039160110	3916MMP	039160150
C41MS/O	041000904		
C41MS/N	041000922		
C41MS/B	041000932		
C41MS/R	041000942		
C41MS/G	041000952		
C41MS/Y	041000962		
C41MS/W	041000972		
C41MS/V	041000982		
C42MCH	042000105		
C45/X	045000010	C45PRO X	045000001
C45/W	045000020	C45PRO W	045000002
C45/AX	045000030	C45PRO AX	045000003
C45/AW	045000040	C45PRO AW	045000004
C45/BX	045000043	C45PRO BX	045000021
C45/BW	045000053	C45PRO BW	045000022
C45/CX	045000063	C45PRO CX	045000023
C45/CW	045000073	C45PRO CW	045000024
C45/DX	045000075	C45PRO DX	045000031
C45/DW	045000076	C45PRO DW	045000032
C45/EX	045000078	C45PRO EX	045000033
C45/EW	045000079	C45PRO EW	045000034
C45/BPX-1,3	045000083	C45PRO BPX-1,3	045000041
C45/BPX-2,0	045000090	C45PRO BPX-2,0	045000042
C45/BPW-1,3	045000093	C45PRO BPW-1,3	045000051
C45/BPW-2,0	045000100	C45PRO BPW-2,0	045000052
C45M7A/X	045000160	C45PRO M7A/X	045000161
C45M7A/W	045000170	C45PRO M7A/W	045000171
C45C7	045000207	C45PRO C7	045000227
C45MA	045000212	C45PRO MA	045000232
C45M5	045000215	C45PRO M5	045000235
C45M7	045000217	C45PRO M7	045000237
C45MS	045000219	C45PRO MS	045000239
C45PM	045000301	C45PRO PM	045000302
C45PF	045000311	C45PRO PF	045000313
C45SS	045000332	C45PRO SS	045000333
C45SL	045000365	C45PRO SL	045000366
C45CORNER/X	045000400	C45PRO C/X	045000401
C45CORNER/W	045000410	C45PRO C/W	045000411
C45AS1	045000450	C45PRO AS1	045000451
C45AS2	045000480	C45PRO AS2	045000481
C58P-O	058000121	C58P-O	058000221
C58P-G	058000122	C58P-G	058000222
C58P-R	058000123	C58P-R	058000223
C63E/W	063000010		
C63G/C	063000020		
6600 M/379	066000379	6600 M/380	066000380
6600 M/640	066000640	6600 M/643	066000643
7217FB 35	072170135	7217FG 35	072170235
7217FB 36	072170136	7217FG 36	072170236
7217FB 37	072170137	7217FG 37	072170237
7217FB 38	072170138	7217FG 38	072170238
7217FB 39	072170139	7217FG 39	072170239
7217FB 40	072170140	7217FG 40	072170240
7217FB 41	072170141	7217FG 41	072170241
7217FB 42	072170142	7217FG 42	072170242
7217FB 43	072170143	7217FG 43	072170243
7217FB 44	072170144	7217FG 44	072170244
7217FB 45	072170145	7217FG 45	072170245
7217FB 46	072170146	7217FG 46	072170246
7217FB 47	072170147	7217FG 47	072170247
7217FB 48	072170148	7217FG 48	072170248
7252NKK 38	072520138	7356G 38	073560038
7252NKK 39	072520139	7356G 39	073560039
7252NKK 40	072520140	7356G 40	073560040
7252NKK 41	072520141	7356G 41	073560041
7252NKK 42	072520142	7356G 42	073560042
7252NKK 43	072520143	7356G 43	073560043
7252NKK 44	072520144	7356G 44	073560044
7252NKK 45	072520145	7356G 45	073560045
7252NKK 46	072520146	7356G 46	073560046
7252NKK 47	072520147	7356G 47	073560047
7253NKK 38	072530138	7357G 38	073570038
7253NKK 39	072530139	7357G 39	073570039
7253NKK 40	072530140	7357G 40	073570040
7253NKK 41	072530141	7357G 41	073570041
7253NKK 42	072530142	7357G 42	073570042
7253NKK 43	072530143	7357G 43	073570043
7253NKK 44	072530144	7357G 44	073570044
7253NKK 45	072530145	7357G 45	073570045
7253NKK 46	072530146	7357G 46	073570046
7253NKK 47	072530147	7357G 47	073570047
7300MK 36	073000636		
7300MK 37	073000637		
7300MK 38	073000638		
7300MK 39	073000639		
7300MK 40	073000640		
7300MK 41	073000641		
7300MK 42	073000642		
7300MK 43	073000643		
7300MK 44	073000644		
7300MK 45	073000645		
7300MK 46	073000646		
7300MK 47	073000647		
7300MK 48	073000648		
7300FT 36	073000736		
7300FT 37	073000737		
7300FT 38	073000738		
7300FT 39	073000739	7362B 39	073620039
7300FT 40	073000740	7362B 40	073620040
7300FT 41	073000741	7362B 41	073620041
7300FT 42	073000742	7362B 42	073620042
7300FT 43	073000743	7362B 43	073620043
7300FT 44	073000744	7362B 44	073620044
7300FT 45	073000745	7362B 45	073620045
7300FT 46	073000746	7362B 46	073620046
7300FT 47	073000747	7362B 47	073620047
7300FT 48	073000748	7362B 48	073620048
7314AB 35	073140335	7314AF 35	073140235
7314AB 36	073140336	7314AF 36	073140236
7314AB 37	073140337	7314AF 37	073140237
7314AB 38	073140338	7314AF 38	073140238
7314AB 39	073140339	7314AF 39	073140239
7314AB 40	073140340	7314AF 40	073140240
7314AB 41	073140341	7314AF 41	073140241
7314AB 42	073140342	7314AF 42	073140242
7314AB 43	073140343	7314AF 43	073140243
7314AB 44	073140344	7314AF 44	073140244
7314AB 45	073140345	7314AF 45	073140245
7314AB 46	073140346	7314AF 46	073140246
7314AB 47	073140347	7314AF 47	073140247
7314AB 48	073140348	7314AF 48	073140248
7319ESD 36	073190236		

ELIMINATED ITEMS - SUBSTITUTE/RECOMMENDED ITEMS

	ELIMINATED ITEM
	SUBSTITUTE ITEM
	RECOMMENDED ITEM

7319ESD 37	073190237		
7319ESD 38	073190238		
7319ESD 39	073190239		
7319ESD 40	073190240		
7319ESD 41	073190241		
7319ESD 42	073190242		
7319ESD 43	073190243		
7319ESD 44	073190244		
7319ESD 45	073190245		
7319ESD 46	073190246		
7319ESD 47	073190247		
7319ESD 48	073190248		
7577N XS	075770000		
7577N S	075770001	7579T S	075790001
7577N M	075770002	7579T M	075790002
7577N L	075770003	7579T L	075790003
7577N XL	075770004	7579T XL	075790004
7577N XXL	075770005	7579T XXL	075790005
7577N XXXL	075770006	7579T XXXL	075790006
7734 S	077340001	7670G S	076700001
7734 M	077340002	7670G M	076700002
7734 L	077340003	7670G L	076700003
7734 XL	077340004	7670G XL	076700004
7734 XXL	077340005	7670G XXL	076700005
7734 XXXL	077340006	7670G XXXL	076700006
7811 S	078110001	7810 S	078100101
7811 M	078110002	7810 M	078100102
7811 L	078110003	7810 L	078100103
7811 XL	078110004	7810 XL	078100104
7811 XXL	078110005	7810 XXL	078100105
7820 XS	078200000	7650 XS	076500000
7820 S	078200001	7650 S	076500001
7820 M	078200002	7650 M	076500002
7820 L	078200003	7650 L	076500003
7820 XL	078200004	7650 XL	076500004
7820 XXL	078200005	7650 XXL	076500005
7820 XXXL	078200006	7650 XXXL	076500006
7820 XXXXL	078200007		
7821 XS	078210000		
7821 S	078210001		
7821 M	078210002		
7821 L	078210003		
7821 XL	078210004		
7821 XXL	078210005		
7821 XXXL	078210006		
7821 XXXXL	078210007		
7823 XS	078230000		
7823 S	078230001		
7823 M	078230002		
7823 L	078230003		
7823 XL	078230004		
7823 XXL	078230005		

7823 XXXL	078230006		
7823 XXXXL	078230007		
7825 XS	078250000		
7825 S	078250001		
7825 M	078250002		
7825 L	078250003		
7825 XL	078250004		
7825 XXL	078250005		
7825 XXXL	078250006		
7825 XXXXL	078250007		
7829 XS	078290000		
7829 S	078290001		
7829 M	078290002		
7829 L	078290003		
7829 XL	078290004		
7829 XXL	078290005		
7829 XXXL	078290006		
7829 XXXXL	078290007		
7833ST XS	078330000	7933G XS	079330300
7833ST S	078330001	7933G S	079330301
7833ST M	078330002	7933G M	079330302
7833ST L	078330003	7933G L	079330303
7833ST XL	078330004	7933G XL	079330304
7833ST XXL	078330005	7933G XXL	079330305
7833ST XXXL	078330006	7933G XXXL	079330306
7835ST XS	078350000	7935G XS	079350300
7835ST S	078350001	7935G S	079350301
7835ST M	078350002	7935G M	079350302
7835ST L	078350003	7935G L	079350303
7835ST XL	078350004	7935G XL	079350304
7835ST XXL	078350005	7935G XXL	079350305
7835ST XXXL	078350006	7935G XXXL	079350306
7991N S	079910001	7996N XS-S	079960000
7991N M	079910002	7996N M-L	079960002
7991N L	079910003	7996N M-L	079960002
7991N XL	079910004	7996N XL-XXL	079960004
7991N XXL	079910005	7996N XL-XXL	079960004
7992N S	079920001	7996N XS-S	079960000
7992N M	079920002	7996N M-L	079960002
7992N L	079920003	7996N M-L	079960002
7992N XL	079920004	7996N XL-XXL	079960004
7992N XXL	079920005	7996N XL-XXL	079960004
8016DA 6	080160092	8016 6	080160006
8016DA 5	080160093	8016 5	080160005
8016DA 10	080160096	8016 10	080160010
8016DA 8	080160098	8016 8	080160008
8020 2-3	080200003	8020A 2-3	080200503
8020 4	080200004	8020A 4	080200504
8020 5	080200005	8020A 5	080200505
8020 6	080200006	8020A 6	080200506
8020 8	080200008	8020A 8	080200508
8020 10	080200010	8020A 10	080200510
8020 12	080200012	8020A 12	080200512
8020 14	080200014	8020A 14	080200514
8020 16	080200016	8020A 16	080200516
8020 18	080200018	8020A 18	080200518

8020 20	080200020	8020A 20	080200520
8020 22	080200022	8020A 22	080200522
8020 25	080200025	8020A 25	080200525
8021 40	080210040	8021B 40	080210140
8041 M24	080410224	8041HP M24	080410225
8043 M20	080430220	8043HP M20	080430221
8050D10	080500954		
8189PA 100X60	081890060	8189PA 135X90	081890090
8282 3	082820203	8282S 3	082820303
8282 4	082820204	8282S 4	082820304
8282 5	082820205	8282S 5	082820305
8282 6	082820206	8282S 6	082820306
8282 8	082820208		
9510 XS	095100000		
9510 S	095100001		
9510 M	095100002		
9510 L	095100003		
9510 XL	095100004		
9510 XXL	095100005		
9525BB	095250020	9525TL	095250010
9525N	095251021	9525TL	095250010
9533N S	095330051	9502TL S	095020051
9533N M	095330052	9502TL M	095020052
9533N L	095330053	9502TL L	095020053
9533N XL	095330054	9502TL XL	095020054
9533N XXL	095330055	9502TL XXL	095020055
9534W S	095340011	9534WO S	095340031
9534W M	095340012	9534WO M	095340032
9534W L	095340013	9534WO L	095340033
9534W XL	095340014	9534WO XL	095340034
9534W XXL	095340015	9534WO XXL	095340035
9534B S	095340051	9534BO S	095340071
9534B M	095340052	9534BO M	095340072
9534B L	095340053	9534BO L	095340073
9534B XL	095340054	9534BO XL	095340074
9534B XXL	095340055	9534BO XXL	095340075
9572MB S	095720701	9572LB S	095720801
9572MB M	095720702	9572LB M	095720802
9572MB L	095720703	9572LB L	095720803
9572MB XL	095720704	9572LB XL	095720804
9572MB XXL	095720705	9572LB XXL	095720805
9577M XXL	095770055		
9577M XXXL	095770056		
9598W M	095980110	9598W M-N	095980130
9598W L	095980112	9598W L-N	095980132
9598WHP M	095980120	9598WHP M-N	095980140
9598WHP L	095980122	9598WHP L-N	095980142
9599CB	095990011	9599CB-N2	095990031
9744 (1)	097440040		
9744 (2)	097441040		

Abrasive discs	514÷516, 527
Abrasive shaft-mounted wheels	517÷520
Adjustable wrenches	24, 280, 287, 294, 300
Amperometric clamps	233-234
Anti-waste rolls	528
Assortments of tools in thermoformed trays	478÷502
Auto-darkening LCD mask	249-250
Automatic cable reels with inspection lamps	246-247
Automatic hose reel for compressed air or cold water	326
Barrel pumps	253
Battery tools	306
Beta Abrasives	513÷528
Beta Chemicals	507÷511
Beta Collection	641÷651
BetaEVOX screwdrivers	143÷145
BetaGrip screwdrivers	148÷151, 283-284
BetamaX screwdrivers	153, 295, 303
Bevel gearbox	82
Bevel protractor	215
Bicycle tools	274÷277
Bit reamers	220-221
Bits and bit holders	24, 27, 76÷83, 146-147, 151, 280
Bits for drilling, threading and countersinking	46
Blister pack range	535÷548
Blocks and hoists	622-623
Bolt cutters	132
Bonding guns	228
Bottle holders	354
Bristle brush	226
Brushes	225-226, 305
Cable cutters	135-136
Cable stripping tools and wire stripping pliers	136-137
Callipers	215-216
Cape chisels	10
Carpenter's pencil	217
Centre punches	10
Chalk line reels and powder	219
Circlip pliers	126-127, 169, 205, 288, 302
Closed end terminals	531
Combination pliers	137-138, 283, 289, 294, 303
Combination wrenches	11÷13, 25-26, 286, 293, 298
Combo tool cases and accessories	341÷345
Covers for tool chests	370, 374
Crimping pliers for terminals and terminals	209÷211, 530
Crowfoot wrenches, 3/8" square drive	94
Cutting nippers for electronic purposes	141-142
De-icer spray	511
Desoldering pumps	241
Detergents	510-511
Diagonal and end cutting nippers	130-131, 141-142, 282, 288, 294, 303
Dial indicators	214
Dies and assortments	46÷50
Digital litre counter for oil	253



Digital tachometer	234
Display units for sales points	535÷561, 602
Double ended hexagon / bi-hex offset socket wrenches	109-110, 287, 302
Double swivel end socket wrenches	15
Double-ended offset ring wrench for scaffolding bolts	17, 299
Drift punches	9, 297
Electric platform cart	375
Electrician's scissors	134-135, 282, 288
Electronic torque meter with Dynatester transducer	59, 69
Electronic videoscope	120
Engineer's scribes	216
Extractors for damaged screws and studs	166-167
Extra-flat chisels with straight cutters	123, 157-158
Files	157, 221÷224, 305
Filtering mask	601
Fitting tool for ties and ties	227, 534
Fixed frame hacksaw	225
Flap discs	520÷527
Flap/non-woven wheels	525÷527
Flare nut open ring wrenches	17, 24, 26
Flat chisels	10, 286, 293, 297
Flexible magnetic pickup tools	220
Flexible pickup tools	220
Fluid extractor	252-253
Folding tool trolley	344, 375
Footboard	237
Friction tape	534
Graduated rules	216, 290
Hacksaw frames and blades	224-225
Hammers	158, 161÷163, 289, 295, 303-304
Hand crimper steel matrix	130
Hand punch steel punch and matrix	130, 211
Hand sockets, accessories and assortments, 1/4"	84÷91
Hand sockets, accessories and assortments, 3/8"	91÷96, 280-281, 300
Hand sockets, accessories and assortments, 1/2"	97÷106, 281-282, 287, 294, 301
Hand sockets, accessories and assortments, 3/4"	106-107, 301-302
Hand sockets, accessories and assortments, 1"	108
Hand taps and assortments	43÷45, 48÷50
Heat guns	247-248
Heating plates for manual straight and slanted welding of plastic pipes	27
Heavy-duty cable cutters	132
Hi-torque hexagon nut spinners with handles	111, 282
Holesaws and hole cutters and accessories	50÷52
Hook wrenches	23-24, 300
Hot glue guns	248
Hub and wheel drum pullers	201-202
Hydraulic press	207
Hydraulic pullers	207
Impact screwdrivers	154-155
Impact sockets, accessories and assortments	69÷76
Industrial tool chests	361-362
Inspection mirrors	220
Instant glue	509
Insulated tools, 1000V	278÷284

Insulating gloves	284
Insulating mat	284
Kneeling pad	259-260
Knives	238-239
Lamps	242÷245
Laser meters	217
Lever clamps	208
Lever operated grease guns	228-229
Lever-operated grease gun	228
Lifting airbag	240
Liquid gasket	508
Locker	508
Locking wire pliers	235
Long and extra-long nose pliers	125-126, 138÷140, 283, 289, 303
Lump hammers	164, 304
Magnetic squares for welders	249
Magnetic tool holders	237
Magnetizer/demagnetizer	142
Mains testing screwdrivers	146
Masonry chisels	218-219
Measuring tapes	217
Metric feeler gauges	220
Micrometers	213
Microscrewdrivers	145÷147
Mobile roller cabs	349÷357, 363÷371, 397-398, 420
Mobile workstation	360
Morse taper extractors	43
Motorcycle tools	268÷273
Multilayer pipe gauge	30
Multimeters	232-234
Nut splitters	220
Nylon clamps	531÷534
Nylon wire puller	211
Offset key wrenches for hexagon and Torx® head screws, with high torque handles	21-22, 286-287, 294
Offset key wrenches for hexagon and Torx® head screws	18÷23,
Offset key wrenches with XZN® profile	23
Offset screwdrivers	145
Oil cans	229
Oil gun	253
Oil pressure pump	159
Panel toolholders	382, 406, 423
Paper roll holders	354
Parallel bench vices	208
Pen oiler	230
Pin punches	10, 297
Pincers	131-132
Pipe benders	33
Pipe cutters	28÷30, 300
Pipe reamers	30
Pipe wrenches	32-33, 287, 294, 300
Pivoting clamp vices, for plumbing purposes	34
Plastic barrier chains and posts	601
Plastic repair kit	161



Pliers for electronic purposes	140
Plumbing tools	27÷34
Pneumatic tools and accessories	307÷329
Polywelders and forms	27
Portable tool chests	346÷348, 367
Pre-insulated terminals	530
Protractors	215
Pry bars	120-121, 219, 302
Pullers	198÷207
Punch press	211
Punches	132-133
Radius gauges	220
Ratcheting wrenches	17, 25÷27, 287
Ratchet-type shears for PVC pipes	29
Reversible screwdrivers	151-152
Revolving punch pliers	236
Ring wrenches	15÷17, 280, 286, 298-299
Riveting pliers and rivets	226-227
Robur wire rope accessories	603÷639
Safety footwear	564÷586
Safety goggles	601
Scissors	135, 239, 305
Scrapers	168, 183, 220-221, 238, 305
Screw clamps	208
Screw pitch gauge	220
Screwdrivers with steel heads	145-146
Screwholding screwdrivers	146
Seat with castors	259
Self-locking pliers	128÷130, 288, 303
Shears	133-134
Silicone sealant	509
Single and double open end wrenches	14-15, 280, 286, 298
Sledge hammers	164, 304
Slip joint pliers, boxed joints	127-128, 138, 282, 288, 294, 303
Slogging wrenches	14-15, 298-299
Soft face hammers	164-165, 289, 304
Soldering irons	240-241
Sparkproof axe	305
Sparkproof pick	305
Sparkproof safety valve wrenches	302
Sparkproof shovel	305
Sparkproof tools	297÷305
Spatulas	225, 305
Special end mills for welding	40
Spirit levels and levelling staffs	218
Spotlights	243
Spray cleaner	510
Spray grease	509-510
Spray guns	326
Spray silicone	510
Spray unlocking lubricant	509
Spray zinc	511
Spring puller	224
Spring tweezers	124-125, 282

Squares	214-215
Stainless steel helicoids	45-46
Stainless steel tools	292÷296
Stepped drills	40-41
Suction lifters	236
Support for impact wrenches	312
Tap wrenches and die stocks	45, 48
Tethered tools	285÷291
T-handle socket wrenches for hexagon and Torx® head screws	111÷114
T-handle wrenches with three male ends for hexagon and Torx® head screws	112÷114, 282, 293, 299-300
Thermal camera	235
Thermoformed tool trays	479÷503
Thermometers	235
Thread sealant	507
Threadlocker	507
Three-leg pullers	199÷201, 207
Tool accessories for cabinets, drawers and panels	503÷505
Tool assortments	427÷502
Tool bags	333÷338
Tool boxes	337÷340
Tool cabinets	379, 408
Tool cabinets, sheet metal	409÷411, 425
Tool cases	331÷335
Tool chest trolleys	347
Tool pouches with belts	333
Tool rucksack	336
Tool trolleys, 2 wheels	511
Tool trolleys, 4 wheels	357÷359, 374, 376-377, 402
Tool trunks	338, 340
Torches	242
Torque angle indicators	60
Torque bars	61, 66÷68
Torque multipliers	54-55
Torque screwdrivers	59
Torque wrenches and bars	60÷68, 280, 287
Tube flaring tools	31
Tubular socket wrenches	109-110
Twist drills with cylindrical shanks	35÷40
Two-leg pullers	197÷199, 201, 207
Ultrasonic cleaning tank	257
Utility knives	237-238
Vacuum cleaners for solid and fluid	250-251
Vehicle repair	115÷123, 156÷161, 165÷197, 230÷232, 252÷267
Voltage tester	235
Warning and prohibition signs	601
Waterproofing spray	511
Welding machines	249
Wood rip saw	225
Work mat	270, 386, 654
Workbenches	378, 380÷386, 391÷396, 419
Workshop Equipment	387÷426
Workshop verniers	212-213
Workwear	587÷602
Wrenches for control panel operators	208

Automotive



Acid densimeter, glass body	231
Adjustable body blade holders with flexible flat blades	157
Air conditioner charging station	256
Air hydraulic jack	266-267
Antifreeze densimeter, glass body	231
Automatic gearbox station	254-255
Ball joint pullers	206
Battery chargers	195-196
Battery fillers	230
Battery lug and post cleaner steel brush	226
Bench sander	258
Brake fluid extractor	176-177
Brake spring pliers	177
Car protectors	259
Chain opening tool	273
Claw hammers	158
Clip pliers	236
Clutch aligners	167
Compressors for shock absorber springs	204-205
Cooling system seal testers	231-232
Creepers	260
Curved angled spoons	157
Dent puller	159-161
Dent reflector	159
Diesel injector test and calibrating hand pump	120
Digital pressure and compression tester	174-176
Dollies	156-157
DSG lever	167
Engine brackets	262-263
Engine oil-filter wrenches	188-192
Exhaust pipe expanders	181
Exhausted oil drain units	251
External butt-ended circlip pliers	169
Feeler gauges for car body repair shops	158
Fluid collection tank	252
Folding hydraulic crane	263
Four-way hexagon wheel nut wrenches	122
Gas oil filter wrenches	190
Gauge for tyre threads	220
Gearbox/transmission trolley	377
Heavy vehicle tools	122-123
Heavy vehicle wheel hub nut locking sockets	121-122

INDEX OF CAR VEHICLE TOOLS

Homokinetic joint pullers	206
Hose clamp pliers	178÷180
Hose pliers	183
Hydraulic bottle jacks	262
Hydraulic car jack with wheels	265-266
Hydraulic pit and under bridge jack	263
Hydraulic press	264-265
Impact sockets for axle nuts	121
Impact sockets for wheel nuts	71-72
Instrument for controlling compression on petrol and Diesel engines	118
Jack and positioner for truck wheels	261
Jack stands	261
Kit for filling diesel oil filters	183
Leaf spring pin sockets	205
Lever for removing wishbone heads from pillar	206
Male guide pins for wheel installation	123
Mobile workstation for diagnostic tools	374
Motorcycle stands	269
Oil seal wrenches	190-191
Packing removal tool	202
Parking sensor punches	161
Part cleaning tank	258
Piston ring compressors	168
Plastic funnel	230, 305
Pneumatic dent puller	159
Pneumatic valve grinder	168
Quick coupler pliers for fuel pipes	184
Reamers for cleaning injector seats	119
Rubber-covered aluminium foil, formable	231
Signal detector	234
Sliding gauges for brake discs and drums	212
Sockets for Diesel engine injectors	115-116
Sockets for Lambda probes	116
Sonoscope probe	197
Spark plug pliers	180
Spark plug wrenches and sockets	115
Spring pulling hook wrenches	166
Square impact sockets for Isuzu wheel nuts	74
Starters	193-194
Stopping knives made of stainless steel	157
Striking tools for installing conical bearings and oil seals	207
Telescopic rod	237
Temperature sensor wrenches	117-118
Tester for batteries and recharging systems	196
Timing devices	169÷172
Tool for disc brake pistons	177-178
Tool for removing and inserting silentblocks	207

INDEX OF CAR VEHICLE TOOLS



Tools for airbag	167
Tools for air-conditioning systems	184-185
Tools for common rail diesel injector	118
Tools for pulling out car radios	236
Tools for releasing electrical connectors	192-193
Tools for removing broken glow plugs	118-119
Tools for removing glass windows	236
Tools for spark plug coils	180
Tools for tyre valves	121-122
Torsion bars for wheel nuts	72, 75
Trim pin removers	182
Tyre inflator	325
Tyre levers	120
Underbody trolley for vehicles	261
Valve depressors for disc removal	177
Valve seat removing tool	169
Valve spring compressors	168
Valve timing system pulley locking tools	173
Vapour extractor	120
Voltage stabilizer	197
Voltage tester	193
Wheel balancing weight tool	123
Wheel covers	122
Wheel hub nut locking sockets	121
Wheel lifter	261
Wheel nut plastic cap pliers	123
Wheeled bodywork spotter	159-161
Window trim tool remover	236
Wrench for natural gas cylinder valves	186-187
Wrench for removing steering arms	206
Wrench for turbines	181
Wrenches for fuel connectors	172
Wrenches for fuel tank floating ring nuts	184
Wrenches for fuel tank floating ring nuts	184

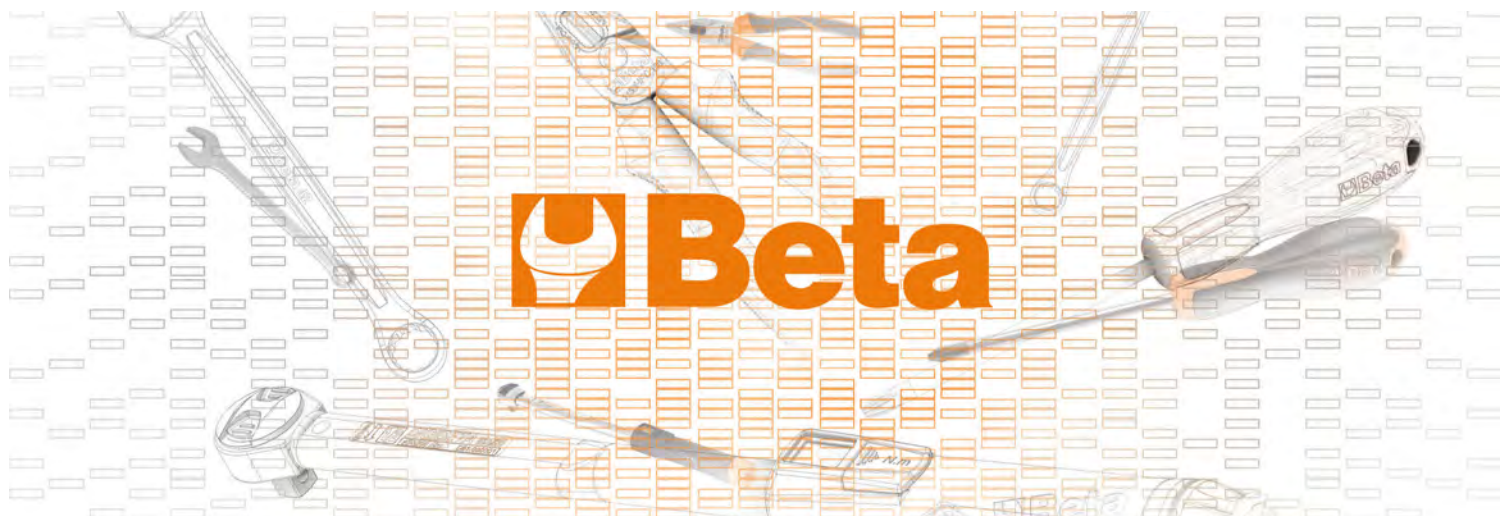

1		1009L/DP	126	1062GM	129	1105T50	133	1148B/R	136
		1009L/DP-S2	126	1063	130	1112	133	1148P	137
100	24	1010	126	1064	130	1112K	541	1149F	137
100/KIT	24	1010BM	126	1065F	130	1114	133	1150	137
110BA	300	1010MQ	282	1065P	130	1118	133	1150BA	303
110MQ	280	1031/S4	126	1067	130	1120A	133	1150BM	137
111	24	1032	126	1077	130	1120ARL - ARG	133	1150BMK	542
111G	24	1032BA	302	1078	130	1122	133	1150G	137
111K	537	1032K	540	1080D	130	1122 - 1125MOL	134	1150GBM	138
111N	24	1033	126	1081	130	1122K	541	1150GBMK	542
120	24	1033K	540	1082	130	1123	133	1150GK	542
120/B6N	24	1034	126	1082BA	303	1123K	541	1150HPC	137
123/K4	25	1034K	540	1082BM	130	1124	134	1150K	542
123E1/4	24	1034L	127	1082BMK	540	1124K	541	1150MQ	283
123Q1/2	24	1036	127	1082G	130	1125	134	1153	138
123Q1/4	24	1036BA	302	1082GBM	131	1126	134	1162	138
123Q3/8	24	1036K	540	1082GBMK	540	1127	134	1162BA	303
141	25	1037	127	1082GK	540	1128BAX	134	1162BM	138
141/B	25	1037K	540	1082K	540	1128BM	135	1162BMK	542
141/S	25	1038	127	1082MQ	282	1128BMX	134	1162G	138
142	25	1038K	540	1084	131	1128BMX/F	134	1162GBM	138
142/B	25	1039	127	1084BM	131	1128BSX	134	1162GBMK	542
142/S	25	1044	127	1084BMK	541	1128FX	134	1162GK	542
142/SC9I-E	25	1044F	127	1084G	131	1128FXS	135	1162K	542
142AS	26	1044FK	540	1084GBM	131	1128MQ	282	1162MQ	283
142AS/S	26	1044K	540	1084GBMK	541	1129BM	135	1164	138
142C	26	1046	127	1084GK	541	1129BMK	542	1164BM	138
142C/A	26	1046BA	303	1084K	540	1130BMX	135	1164BMK	542
142K	537	1046K	540	1084MQ	282	1131CK	135	1164K	542
142MC	25	1047	127	1088	131	1132	135	1164MQ	283
142MC/SC9I-E	26	1047BM	127	1088BM	131	1132BM	135	1166	138
142SN	26	1048	128	1088BMK	541	1132BMK	542	1166BA	303
142SN/S	26	1048BM	128	1088K	541	1132K	542	1166BM	138
142SN/SC9	26	1048K	540	1088MQ	282	1132MQ	282	1166BMK	543
186	26	1048MQ	282	1092V	131	1133	135	1166G	138
187	26	1048V	128	1094V	131	1133RL	136	1166GBM	139
187/B5	26	1048VK	540	1095N	131	1134	136	1166GBMK	543
188	26	1050	128	1096	131	1134A	136	1166GK	543
192	26	1051	128	1096K	541	1134A/RL	136	1166K	543
192/S2	27	1051GM	128	1098	132	1134RL	136	1166MQ	283
194	27	1051L	128	1098K	541	1137BA	303	1168	139
195	27	1051XL	128	1098PL	132	1137BA/RC	303	1168BM	139
195/B5	27	1052	128	1098PLK	541	1142BM	136	1168BMK	543
195AS	27	1052BA	303	1100BA	303	1142BMK	542	1168G	139
195AS/B	27	1052K	540	1101	132	1142MQ	283	1168GBM	139
195K	537	1053	128	1101R	132	1143	136	1168GBMK	543
195P	27	1054	129	1102	132	1143R	136	1168GK	543
195P/B5	27	1055	129	1104	132	1144D	136	1168K	543
1002	125	1056	129	1104R	132	1144D/RG	136	1168MQ	283
1008	125	1057A	129	1105	132	1144D/RL	136	1169/D3	139
1008BM	125	1058	129	1105/C10T	133	1144G	136	1169BM/D3	139
1009	125	1059	129	1105/C16T	133	1144G/RL	136	1169G/D3	139
1009L/A	125	1060	129	1105/C32T	133	1144L	136	1169GBM/D3	139
1009L/B	125	1061	129	1105AD-50	133	1148A	136	1171BM	140
1009L/C	125	1062	129	1105T20	132	1148A/R	136	1172BM	140
1009L/D	126	1062AL	129	1105T30	132	1148B	136	1172BM/P	140

ALPHANUMERIC INDEX

1173BM	140	1229LPH/A6	145	1263/E85	551	1281TX	152	1326	157
1175BM	140	1229PH	145	1263/S12	150	1290	153	1327	157
1177BM	140	1236B	145	1263MC/D8	150	1290/S	153	1328	157
1177BM/Z	140	1238B	145	1264	150	1290K	545	1329	157
1178BM	140	1241	145	1264/S5	150	1290K/INOX	545	1330	157
1178BM/P	140	1242	145	1264K	544	1290N	153	1331	157
1182BM	141	1243/D7	146	1264L	150	1290NK	545	1335BM	157
1183BM	141	1250	146	1265ES	150	1292	153	1337/S5	157
1184BM	141	1251	146	1265ES/S8	150	1292/S4	153	1338	157
1185BM	141	1252/S5	146	1266BP	150	1292K	545	1338A - 1338B	157
1186BM	141	1253	146	1266BP/S8	150	1292K/INOX	545	1338R9 - 1338R12	157
1188BM	141	1253A	146	1267MC/TX	151	1292L	153	1342	157
1190BM	141	1254	146	1267MC/TX-D7	151	1292N	153	1342PM	158
1191BM	142	1256/20	147	1267TX	150	1292NK	545	1342PMR	158
1191BM/L	142	1256/30	147	1267TX/D7	151	1293/D...	154	1343	158
1191R/5-M	142	1256/C36-2	146	1267TX/S13	151	1293/S...	154	1344	158
1200MS	142	1256LP	146	1267TXK	544	1293BP	154	1344A/VW	158
1201E	143	1256PE	146	1268RTX	151	1293BP/S	154	1345	158
1201E/DZ	143	1256PH	146	1268RTX/S8	151	1293BX/DA	553	1351	158
1201E/K	543	1256PZ	146	1268RTXK	544	1293BX/DD	553	1353	158
1201E/S6	143	1256RTX	147	1269N/PZ	151	1293BX/DE	553	1357Z/45	158
1201EN	143	1256TX	147	1269N/PZK	544	1293BX/DF	553	1359T	158
1201EN/K	543	1257BE	147	1269PZ	151	1293ES	154	1360/K6	158
1202E	143	1257ES	147	1269PZ/S4	151	1293ES/S7	154	1360/KP3	158
1202E/K	543	1257ESB/S8	147	1269PZK	544	1294	154	1360G	158
1202E/S4	143	1257LP	147	1270BA	303	1294/S7	154	1361/C12	158
1202EL	143	1257LP/S	147	1272BA	303	1294K	545	1362	159
1202EN	143	1257LPH/S8	147	1272MQ	283	1294L	154	1365/K13	159
1202EN/K	543	1257PH	147	1272MQ/S	283	1295	154	1365P10	159
1203/E1P	550	1257TX	147	1272MQF	283	1295/C14	155	1366/K5	159
1203/E4P	550	1257TX/S	147	1273MQ/D6	283	1297TX	155	1366A	159
1203/E5P	551	1260	148	1273MQ/E1	552	1297TX/D6	155	1366B	159
1203/E10P	551	1260/S6	148	1273MQ/E4	552	1297TX/L	155	1366KF	159
1203E/D	143	1260E	149	1273MQF/D6	283	1297TX/L-S5	155	1366S	159
1203E/S	144	1260EK	544	1274MQ	283	1297TX/S12	155	1366S KIT	159
1204E	144	1260K	544	1274MQ/S	284	1298RTX	155	1366S/R1	160
1204E/K	543	1260MC	149	1274MQF	283	1298RTX/S8	155	1366S/R2	160
1204E/S5	144	1260N	148	1275MQ/C	284	1298RTXK	545	1366S/R3	160
1204EL	144	1260NK	544	1276MQ/C	284	1299N/PZ	155	1366S/R4	160
1205E/ES	144	1262	149	1277BA	303	1299N/PZK	545	1366S/R5	160
1205E/ES-S8	144	1262/S4	149	1279MQ	284	1299PZ	155	1366S/R6	160
1206E/BP	144	1262E	149	1279MQ/F	284	1299PZ/S6	155	1366S/R7	160
1206E/BP-S7	144	1262EK	544	1279MQ/S	284	1299PZK	545	1366S/R8	160
1207E TX/K	543	1262K	544	1281/B28A	152	1302	156	1366S/R9	160
1207E/TX	144	1262L	149	1281BG	151	1303	156	1366S/R10	160
1207E/TX-D	144	1262MC	149	1281BG-TX/A8	152	1304	156	1366S/R11	160
1208E RTX/K	543	1262N	149	1281BG/A9	152	1305	156	1366S/R12	160
1208E/RTX	144	1262NK	544	1281BG/B28NA	152	1305Z	156	1366S/R13	160
1208E/RTX-D	145	1263/D...	149	1281LP	151	1306	156	1366S/R14	160
1209E PZ/K	543	1263/E39	552	1281LPH	152	1307	156	1366S/R21	160
1209E/PZ	145	1263/E40	552	1281PB	151	1308	156	1366S/R22	160
1209E/PZ-S4	145	1263/E50	552	1281PE	152	1309	156	1366S/R24	160
1209EN-PZ/K	544	1263/E62	552	1281PH	152	1310	156	1366S/R25	160
1209EN/PZ	145	1263/E70	551	1281PM	151	1312	157	1366S/R26	161
1229LP	145	1263/E74	551	1281PZ	152	1313	157	1366SL	159
1229LP/S	145	1263/E78	551	1281RTX	152	1314	157	1366ST	160

ALPHANUMERIC INDEX

1367/K10	161	1390/MR...	164	1461/C9B	170	1466/C5	176	1474G	180
1367/S4	161	1390BA	304	1461/C10G	170	1466L 11	176	1474L	180
1368	161	1390BA/R	304	1461/C11A	170	1466TLF	176	1475U	181
1368G/C2U	161	1390N	165	1461/C11G	170	1467	176	1476	181
1368G/CV	161	1390NR	165	1461/C12A	170	1467/RK1	176	1476/RC	181
1368G/K400	161	1390R	165	1461/C12G	170	1467/RK2	176	1476A	181
1368G/OD	161	1391	165	1461/C13A	170	1467LF/2	176	1476A/RC	181
1368G/SD	161	1391A	165	1461/C13B	170	1467LF/RC	176	1476C/1	181
1369/C11	161	1392	165	1461/C17B	170	1467T/C6	177	1476GT	181
1370	161	1392R	165	1461/C18B	171	1467TU	177	1476PSA	181
1370/MR...	162	1393	165	1461/C20G	171	1468N	177	1476T	181
1370BA	303	1410/M	166	1461/C21G	171	1470	177	1477/C10	181
1370BA/MR	304	1428	166	1461/C22B	171	1470FT	177	1477D	181
1370BA/PL	304	1428/SB11	166	1461/C23B	171	1470PF	177	1477D/S5	181
1370F	162	1428L	166	1461/C24B	171	1471	177	1477K/7	181
1370F/MR...	162	1428L/B3	166	1461/C25G	171	1471A	177	1478	182
1370FT	162	1429	166	1461/C27G	171	1471CF	178	1478/3P	182
1370T	162	1429/SB7	166	1461/C28B	171	1471CM	178	1478T	182
1374F	162	1430/...	166	1461/C29B	172	1471CM/E11	178	1479	182
1374F/MR...	162	1430/S	166	1461/C30G	172	1471D2	178	1479/B27	182
1375	163	1431/...	166	1461/C31B	172	1471GF	177	1479L/K4	182
1375/MR	163	1431/C5	166	1461/C32G	172	1471M/50	177	1479L/S2	182
1375A	163	1433	166	1461/C33B	172	1471M/C22	177	1479LB/C5	182
1375B	163	1433/C11	167	1462/KD	172	1471M/P	178	1479LV/S3	182
1375BA/PL	304	1435	167	1462/CF	172	1471M/W50	178	1479ML/B17	182
1376X	163	1435/1	167	1462/CF/C6	172	1471PN/B1	178	1479ML/S3	182
1376X/MR	163	1435/1R	167	1462/CF-SN	172	1471PN/B2	178	1479N/S5	182
1376XT	163	1435R	167	1462/CF-SN/C6	172	1471PN/B3	178	1479RB/1	183
1376XT/MR	163	1437/C12	167	1462/EI	173	1471PN/B4	178	1479RB/2	183
1377	163	1438	167	1462/KI	173	1471PN/B5	178	1479RB/3	183
1377/MR...	163	1438DCT	167	1462/KMRC	173	1471T/C5	178	1479U/13	183
1377BA	304	1438DCT/S	168	1462/KU	173	1472	178	1479U/32	183
1377BA/PL	304	1438DSG	167	1462/MB	173	1472AU	178	1480	183
1377T	163	1438EVO	167	1462AD/BSC	173	1472AU/P	179	1481/C12	183
1378	163	1438K/DSG-2	167	1462AD/SMN	173	1472AU/RP	179	1481K/S4	183
1378/MR...	163	1438K/PWR	168	1462/PIM	173	1472B/RNLT	179	1481PL	183
1379BA	304	1438R	167	1463/KIT	173	1472FC	179	1481PL/S3	183
1379F	163	1439/K7	168	1464ADB	175	1472FC/GE	179	1481T/C12	184
1379F/MR...	164	1440/...	168	1464AP	174	1472FC/L	179	1482	184
1380	164	1445/1 - 1445/2	168	1464AP T	174	1472FCA	179	1482/8 - 1482/10	184
1380/MR...	164	1450GC	168	1464AP T16X12	174	1472FCL/RP	179	1482A/1	184
1380BA	304	1452K	168	1464APB	175	1472H	179	1482A/3	184
1380BA/MR	304	1452PN/K	168	1464CBD	174	1472MT/VW	179	1482A/5	184
1380BA/PL	304	1454P	168	1464FAP	175	1472TM	179	1482B	184
1380S	164	1455SVP	168	1464FG	175	1472R/AU	178	1482C	184
1380S/MR...	164	1455SVP/R...	168	1464FG/CP4	175	1472VW	179	1482D	184
1380T	164	1457/B4	169	1464IC	174	1473	179	1482SN	184
1381	164	1458	169	1464IC/RK	174	1473A	180	1483K/12	184
1381/MR...	164	1460F	169	1464PB	175	1473FN	180	1483K/22	185
1381BA	304	1461/C3B	169	1464PF	176	1473P	180	1483KV-PT/S7	184
1381BA/MR	304	1461/C5G	169	1464PT	175	1473Q	180	1484	185
1381BA/PL	304	1461/C6B	169	1464T	174	1473T	180	1484PSA	185
1381T	164	1461/C6G	169	1464T/SP80	174	1474/C4	180	1485/KIT	185
1385	164	1461/C7B	169	1464TDI	175	1474DL	180	1485BP	185
1385/MR	164	1461/C8B	169	1464VD	175	1474E/VW	180	1485BPM	185
1390	164	1461/C8G	169	1465	176	1474E/VW2	180	1485FCA/K2	185

ALPHANUMERIC INDEX

1485FCA/T	185	1493FT	190	1498MN/12-U	193	1547P	203	1599G	208
1485FCA/TS	185	1493H	190	1498PC	197	1547PC/2	203	1599P	208
1485FRD/T	185	1493HK	190	1498SA/2A-4A	195	1547PL/2	203	1599T	208
1485MJ	186	1493J	190	1498SM	196	1549	203	1600Q 8	208
1485MRC/T	185	1493U/ADB	191	1498SM-A	196	1550U	204	1600Q 10	208
1485PMTJ	186	1493VW	190	1498SM-C	196	1550U/CGS-R	204	1601/PC	209
1485R	186	1493X	190	1498SM-CP	196	1550U/M	204	1602	209
1485R/P10	186	1493Y	190	1498ST/TB	197	1550U/MRC-ABE	204	1602/C9	209
1485R/P17	186	1494	191	1498ST/TB ROT	197	1550U/MRC-C	204	1602A	210
1485TC	185	1494/C14A	192	1498TB/12-24	196	1550U/S...	204	1602BA	305
1485VAG	186	1494BMW	191	1498TC	197	1550U/SS187	204	1603	210
1485VAG/K2	186	1494E	191	1499	197	1552/C9	204	1603A	210
1485VLV/T	185	1494FPC	191	1500/...	197	1551/C20	204	1603B	210
1486/10	186	1494M	192	1500/SP	197	1555/Q	205	1603BK	546
1486/20	186	1494MAN	191	1500G/...	197	1555/QS	205	1603K	545
1486/30	186	1494MRC	191	1500N/...	198	1555C	205	1606/2	210
1486/40	186	1494Q	191	1500N/G...	198	1555S/BMW-RNT	205	1606A	210
1486/50	186	1494T	191	1500N/SP	198	1556/1A	205	1606A/C9	210
1486/60	187	1494T/C5	191	1501/1 - 2 - 3	198	1556/2A	205	1606T	210
1486/70	187	1494VW	191	1501G/1 - 2 - 3	198	1557	205	1607	210
1486/80	187	1494VW/K	191	1501Z/S - P - R	198	1557/S3	205	1608	210
1486/90	187	1494XZN	191	1502/...	198	1557V	205	1608/C9	211
1487/K2	187	1495/C6	192	1505/C5	199	1558/C4	205	1608A	211
1488 - 1488L	187	1495M	192	1505V	198	1558/C13	205	1609	211
1488/1	187	1495T	192	1506	199	1558P	205	1609A	211
1488R...	187	1496/C	192	1508/1 - 1508/2	199	1559	206	1609B	211
1489/31T	187	1497/C23	192	1511/1 - 2 - 3	199	1559V/8T	206	1609C/C5	211
1489/33	187	1497/C94	193	1515/1 - 2 - 3	199	1560/2	206	1609M	211
1489/33P	187	1497/S3	193	1516/1 - 2 - 3	199	1560A	206	1639S	211
1489/C14	188	1497D	192	1517	199	1561/...	206	1640	211
1489/E	187	1497KB/S3	193	1517C/...	200	1562D	206	1640A	211
1489/Y	187	1497P	192	1518/...	200	1563/C4	206	1640K	211
1489R	187	1497RC	193	1518U/...	200	1565/1 - 2 - 3	206	1640P	212
1490	188	1497TE	192	1519/...	200	1566/GO1	206	1640Q	212
1490/R1 - 1490/R2	188	1498	193	1520/1 - 1520/2	201	1566N	206	1640T	212
1490F	188	1498/2A	195	1521/1 - 1521/2	201	1566P	206	1650	212
1491	188	1498/2A-8A-PR	195	1528	201	1567	206	1650FD	212
1491A	188	1498/4A	195	1529	201	1568	206	1650FT	212
1491R	188	1498/4A-8A CO	195	1529/C7	201	1569/A	207	1651DGT	212
1491T	188	1498/4A-8A CP	195	1529/PG	201	1569/B	207	1651DGT/IP	213
1492/1 - 1492/2	188	1498/8A	195	1529PI	201	1569/F	207	1652	213
1492T	188	1498/12	194	1530/C5	201	1569CP	207	1654	213
1493	189	1498/12-24 R20	194	1530/C16	201	1570/3	207	1654DGT	213
1493/C7	190	1498/16A	195	1531/C7	202	1580/8I	207	1656	213
1493/C19	189	1498/24	194	1532	202	1580GL	207	1657DGT/2	213
1493/C30	189	1498/40A	196	1533/...	202	1585/5I - 6I - 7I	207	1658/...	213
1493/PF	189	1498/120A	196	1533PR/1 - 2 - 3	202	1585GI/5 - 6 - 7	207	1658/C4	213
1493/S-U	190	1498B12/R02	194	1534/...	202	1589PI/50 - 100	207	1658DGT	213
1493AL	189	1498LT/12	194	1535/C...	202	- 150		1658SP/1	213
1493AL 4S	189	1498LT/12-24	194	1539	202	1589VI	207	1659	214
1493AL CF	189	1498LT/12-R7	194	1540	202	1590	208	1662/1 - 1662/2	214
1493B	188	1498LT/12-SF	194	1542/1 - 1542/2	203	1591	208	1662AN	214
1493B/S5	188	1498MN/12	193	1544/...	203	1593	208	1662DGT/A	214
1493C/ADB	190	1498MN/12-C	193	1545/C5M	203	1594	208	1662SP0	214
1493DSG	189	1498MN/12-P	193	1547/C6	203	1595	208	1662SP2	214
1493FF	190	1498MN/12-R	193	1547KP	203	1599B	208	1666	214
						1599F	208		

ALPHANUMERIC INDEX

1666A	214	1702N/PM	219	1719BM/RR	224	1739B	226	1758B-RNT	230
1668	214	1702PMR	219	1719BMA...B5	223	1740A	226	1758B/K5	231
1668A	214	1703BA/A	305	1719BMA...M	223	1740B	226	1758BA	305
1670	215	1703BA/P	305	1719BMA...P	223	1741B	226	1758LG	231
1670A	215	1703BA/PL	305	1719BMA...Q	222	1741B/C5	226	1758M	231
1672	215	1704	219	1719BMA...R	223	1741BP	226	1758R	231
1672A	215	1704A	219	1719BMA...S5	223	1741RV...K	227	1758VT	231
1674A	215	1704C	219	1719BMA...T	222	1741U	226	1758VT/L	231
1676	215	1705	219	1719BMB/P	223	1742	227	1759	231
1678/C3	215	1705PT	219	1719BMC	224	1742/C4	227	1759A	231
1679	215	1706DGT	220	1719BMD...B5	223	1742A	227	1759B	231
1679/PR	215	1707	220	1719BMD...M	223	1742A/C	227	1759HD/3	231
1680	215	1707A/1 - 2 - 3	220	1719BMD...P	222	1742A/KR	227	1759HD/RR	232
1680A	215	1708/8 - 13 - 20	220	1719BMD...Q	222	1742KR	227	1759HD/TRUCK	232
1680B	216	1709/10 - 1709/18	220	1719BMD...R	223	1742R-A/M...	227	1759TT	232
1680C	216	1710	220	1719BMD...S5	223	1742R-AL/M...	227	1760/IR500	235
1682	216	1712E/1 - 2 - 3	220	1719BMD...T	222	1743	227	1760/IR1000	235
1683	216	1712TF	220	1719BMR	224	1743T	227	1760/IR1600	235
1685/C7	216	1713M	220	1719BMX...M	223	1749	228	1760/OHM	233
1687/S4	216	1714	220	1719BMX...P	223	1749A	228	1760/RMS	233
1687A	216	1715	220	1719BMX...Q	222	1749A/RB	228	1760/RSE	234
1687AC	216	1715B/R5L	220	1719BMX...R	223	1749A/RT	228	1760/TC2	234
1687D	216	1715FL/A	220	1719BMX...S5	223	1749AC	228	1760B	233
1687U	216	1715FL/B	220	1719BMX...T	222	1750	228	1760DGT	232
1688	216	1715R/FL	220	1719R/...	224	1750CG	228	1760DGT-R3	234
1688A	216	1716A	220	1720/...	224	1750KG10	228	1760DGT/2	233
1688M	217	1716P	220	1720/B	224	1750M	229	1760K	234
1688PC	216	1716Q	221	1720/S	224	1750M3	229	1760PA/80	233
1688PC/R	216	1716R	221	1720D/...	224	1750R/1 - 1750R/2	228	1760PA/AC	234
1690F	217	1716U	221	1720D/B	224	1750RC	228	1760PA/AC-DC	234
1690L	217	1717A	221	1721/B6	224	1750RP/1 - 1750RP/2	228	1760PT	235
1691BM	217	1717B	221	1723	224	1750RT	228	1760R/TC2	234
1692	217	1717BA	305	1725	224	1750TA	228	1760TMC	235
1693	217	1717BA/1	305	1725CR	224	1750TLA	228	1761	235
1693M	217	1717C	221	1725MQ	284	1751	229	1761RS/1	235
1694/L	217	1717D	221	1726	224	1751R	229	1762	236
1694A/L	217	1717T	221	1726BM	225	1752	229	1762K	546
1694B/L	217	1717T RS	221	1727	225	1752R	229	1763	236
1695XS	218	1717T RT	221	1727BA	305	1753	229	1763G/S500	236
1696	218	1717V	221	1727BM	225	1753R	229	1765/C24	236
1696A	218	1717V R	221	1728...	225	1754	229	1766	236
1696B	218	1718A...M	222	1728BA	305	1755	229	1766/8	236
1696D	218	1718A...P	222	1729	225	1756	229	1766A	236
1696S	218	1718A...Q	221	1729CG	225	1756B	229	1766ER	236
1697	218	1718A...R	222	1729DM 450	225	1756C	230	1766ER/VW	236
1699L	218	1718A...S5	222	1729LR	225	1756C-2OR	230	1766G	236
1699L/1	218	1718A...T	222	1730	225	1756D	230	1766I	236
1699Q	218	1718D...M	222	1730M	225	1756D-2OR	230	1766L	236
1700N	218	1718D...P	222	1730V 38	225	1756G	230	1766LI	236
1700N/PM	219	1718D...Q	221	1736A	225	1757	230	1766T	237
1701BA	305	1718D...R	222	1737	225	1757A	230	1767A	237
1701N	219	1718D...S5	222	1737AC	225	1758	230	1767B	237
1701N/PM	219	1718D...T	221	1737B	226	1758A	230	1767PMC	237
1701NE/...	219	1719BA8	305	1737BA	305	1758ADB-45°	230	1767PMR	237
1701PMR	219	1719BA12	305	1737NX	225	1758ADB-D	230	1768	237
1702N	219	1719BM/RL	224	1738	226	1758B	230	1770	237

ALPHANUMERIC INDEX

1770A	237	1827PC	240	1851VK-12V	248	1885/C1-R7	255	1916JF	327
1770BM	237	1827PCL	240	1852R1750	248	1885/C1-R8	255	1916JM	327
1770RL	237	1827PFL	241	1852S-CC	248	1885/C2	255	1916P	327
1771	237	1830T	241	1852S-CNT	248	1885/C2-R1	255	1916S	328
1771BM	237	1833L	242	1852S-F	248	1885/C2-R2	255	1917F	328
1771HD	237	1833L/USB	242	1852S-FLESS	248	1885/C2-R3	255	1917JF	328
1771RL	237	1833M	242	1852S-KR/CNT	248	1885/C2-R4	255	1917JM	328
1772H	238	1833RB-L/USB	242	1852S-L	248	1885/C2-R5	255	1917M	328
1772M	238	1833S	242	1852 S-PIATTE	248	1885/C2-R6	255	1917RG	328
1772R	238	1833XL	242	1860 160A	249	1885/C2-R7	255	1917SP	328
1772RL/2	238	1833XS/1	242	1860EI	249	1885/C3	255	1917ST	328
1773A	238	1833XS/2	242	1860RC	249	1885/C3-R1	255	1918	328
1773RL	238	1834RR	242	1860RG	249	1885/C3-R2	255	1918N	328
1774	238	1836A	242	1860SQ	249	1885/C3-R3	255	1918R	328
1774A	238	1836B	242	1870	250	1885/C3-R4	256	1919F1/2	329
1774A/RL	238	1837C	243	1870-20/5S	251	1885/C3-R5	256	1919F1/4	329
1774S	238	1837F	243	1870-72 /FC	251	1885/C3-R6	256	1919F3/8	329
1776BA	305	1837F/USB	243	1870-72/FL	251	1885/C3-R7	256	1919FE1/4	328
1777BM	238	1837M	243	1870I	250	1885/C3-R8	256	1919L	329
1777BMT	238	1837RB-F/USB	243	1872L	250	1885/C3-R9	256	1919ML	329
1777MQ/C	284	1837S	243	1872L 35/5S	251	1885/C3-R10	256	1919RB-F	329
1777MQ/U	284	1838/11LED	244	1872L 35/FC	251	1889	254	1919RB-FE1/4	329
1777RL/U	284	1838AM	244	1873	250	1889CF	254	1919RF-F	329
1777T	238	1838COB	244	1873-30/5S	251	1893/134A	256	1919RF-FE1/4	329
1778AN	238	1838E	245	1874	251	1893/1234YF	256	1919RM-F	329
1778AX	238	1838E-BT	245	1874-50/5S	251	1893TR/134A	256	1919RM-FE1/4	329
1778CM	239	1838FLASH	243	1874-50/FC	251	1893TR/1234YF	256	1919SC	329
1778D	239	1838P	244	1877	251	1893TR/CI	257	1921B1	310
1778M7	239	1838RA/10-11LED	244	1877A	251	1895 6	257	1921M1	310
1778P	239	1838RB/10LED	244	1878 2	252	1895 13	257	1921M2	310
1778SCL	239	1838RB/FLASH	243	1878 3	252	1895 27	257	1921N3	310
1778SOS	239	1838RR/11LED	244	1878 4	252	1895/RC	257	1922P1	310
1778U	239	1838RV/11LED	244	1878 8	252	1895/S	257	1922P2	310
1778V18	239	1838S	245	1878 11	252	1895G	257	1922P3	310
1778X	239	1838SL	244	1878 30	252	1897	258	1924B	311
1781	239	1838SLIM	244	1879	252	1897/CRB	258	1924CD	311
1783	239	1838UV	245	1879 6	252	1897/G	258	1924F	310
1784	239	1839/R1	245	1879/FUEL	253	1897/MV	258	1927AN	312
1784BA	305	1839/R2	245	1879R/K4	253	1898/B	258	1927B	311
1800/100	240	1839/R4	245	1880	253	1898/D	258	1927B/K5	311
1808	240	1840BM	245	1880ADB	253	1898/K40	258	1927CD	311
1812 150	240	1842	246	1881	253	1899A	258	1927CD/K3	311
1814M	240	1842LED/ABM	245	1882	253	1900M 8X15 -	326	1927G	312
1820	240	1842LED/BM	245	1883	253	1900M 10X15	326	1927P	312
1820 60	240	1843	246	1883NC	253	1900S 8x10	326	1927P/K3	312
1820 80	240	1844	247	1884	253	1914	326	1927SP-AM	312
1822	240	1844SCK	247	1884/C12	253	1915B	326	1927XM	312
1822 180	240	1845	247	1884N/C8	254	1915C	327	1927XM/K5	312
1822 320	240	1846	247	1885	254	1915C/L	327	1928CD	313
1823 60	240	1846R-LED/BM	246	1885/C1	254	1915D	327	1928DA	313
1823R/60	240	1847	247	1885/C1-R1	254	1915E	327	1928DAL	313
1824R	240	1848	247	1885/C1-R2	254	1915E/XL	327	1928K4	313
1825B	240	1850D	247	1885/C1-R3	254	1916G	327	1928XM	313
1827	240	1850E	248	1885/C1-R4	254	1916GF	327	1930A	314
1827/K	241	1851VK	248	1885/C1-R5	255	1916GFE	327	1930CD	313
1827F	241	1851VK-12C	248	1885/C1-R6	255	1916I	327	1930HLA	314

ALPHANUMERIC INDEX

1930LA	314	1944N	321	2001/BZ27 VU	332	2400 RSC24/PF-	354	338	28
1930LH	314	1944PA	321	2001/BZV	331	2400 RSC24/PL	354	338R	29
1930PA	314	1945C	321	2002/BV6	332	2400 RSC24/SPC	354	338R/I	29
1930ZL	314	1945C/G...	321	2002/BV7-ZIP	332	2400-COVER RSC24	370	338RP	29
1931AN10	315	1945C/GP...	322	2002/BV8	332	2400-COVER RSC24AXL	370	339A	29
1931CD6	315	1945P	322	2002/BV9	332	2499PC	355	339A/R	29
1931CD10	315	1945P/S...	322	2002/BVL6	332	2499PF	355	340	29
1931CD13	315	1945S	321	2002/BV12	332	2499PF/M	355	340C	29
1932B10	315	1945S/G...	321	2002/BV13	333			340C/KRL	29
1932B13	316	1946C/T...	322	2005PA/D	333	3		340RL	29
1932RS13	315	1946C4,8	322	2005PA/S	333			341	29
1933	316	1946C7,8	322	2009ID	333	30	9	341B	29
1933AN90	317	1946KF	322	2009N/BV	333	30BA	297	341B/RL	29
1933AN90-H	316	1946KF/M...	323	2028/VV	333	31	9	341B/RM	29
1933I	316	1946T	322	2028E	333	31/B6N	9	341RL	29
1933IH	316	1947	323	2029/RT	333	31/B6N-LSE	10	342	30
1933IL	316	1947G	323	2029/VV	333	31BA	297	342A	30
1933ILH	316	1947G2	323	2029E	333	31BA/C	297	342A/MOL	30
1933L	316	1947H	323	2032/TE	334	31BM	9	342A/RL	30
1934BV	317	1947M	323	2032/TV	334	31BM/D6	9	342MOL	30
1934MAV	317	1947M -...	323	2033L	334	31L	10	342P	30
1934MAV70	317	1948	323	2033L/VV	334	31SE	10	342P/RL	30
1935F	317	1948PR	324	2036/TV	334	31SP6	9	342RL	30
1936/4A	317	1949BC	324	2036E	334	32	10	345	30
1936/5A	318	1949BC/RU	324	2037/TV	334	32AU	10	345C	30
1936/7A	318	1949DGT/2	325	2038/TV	334	32AUR	10	345SB	30
1937	318	1949F	325	2041UC	335	32BA	297	345SB/R	30
1937 2,5	318	1949G	325	2051N	335	34BA	297	345U	30
1937C...	318	1949GPA	325	2055HB	335	34	10	345U/A	30
1937K...	319	1949GPN	325	2060/VV	335	35	10	349	30
1937KC	318	1949M	325	2080/D10	335	35PM	10	349/SMAS	31
1937KL	318	1949P	324	2080/V6	335	35PMR	10	349/SMM	30
1937KL-D	319	1949R	326	2080/V6-U	335	36	10	350	31
1937M	319	1949T	325	2080/V12	335	37	10	351C	31
1937M-01÷11	319	1949U5	324	2080/V12-...	336	37PM	10	351P	31
1937N10	319	1949U5/A	324	2115P L-MQ32	282	37PMR	10	352C/U	31
1937N10-GR	319	1949U5/B	324	2200-COVER RSC22	370	38/B6N	10	352U	31
1937N20	319	1949U5/C	324	2250-O	259	38/DS1	549	353N	31
1937N20-GR	319	1949U5/D	324	2251-O	259	38/DS2	549	353N/C6	31
1937R/P	318	1949U5/E	324	2252	259	38/SP6	10	353NM	31
1938	319	1949U5/F	324	2252KR4	259	39BA	298	355	31
1938R/L	320	1949U5/G	324	2254A	259	310	27	357F3	31
1938R/S5	320	1951	326	2254C	259	310/C4	27	357R/F3	31
1940	320	1951A	326	2254F	259	310/C8	27	358	32
1940/C6	320	1952	326	2254K	259	310B	27	358RL	32
1940/S5	320	1995MQ/G1 - G2	284	2254SM	259	311	27	359	32
1940E10	320	1995MQ/T	284	2254T	260	330	28	359CH	32
1940E10/MT	320	1996MQ/GM	284	2258-O	259	330BA	300	360	32
1940E10/S...	320	1996MQ/T	284	2300-COVER RSC23	370	330BA/2R	300	360R/...	32
1940E10/S5	321	1996SVG	284	2300-COVER RSC23T	370	330R/A	28	362	32
1940MT	320			2300ST/KIT	348	330R/I	28	362R/...	32
1940S...	320			2400 RSC24/PC	354	332	28	363	32
1942A	321			2400 RSC24/PD	354	334	28	363BA	300
1942LR	321			2400 RSC24/PF	354	334R	28	363R/...	32
1944A	321					334R/I	28	365	32
1944AR 2	321					336	28	365R/...	32

ALPHANUMERIC INDEX

366	32	3012I	262	3050/600	270	3912TP/QRE	275	42BA-AS	298
374	32	3014	262	3050/CC	269	3912TP/ROAD	275	42LMP	13
374K	537	3014R/GR5	262	3050/KA	270	3912TP/RS	275	42LMP/S	13
374R/...	33	3014 SAR	262	3050/LA	270	3912TP/ST	275	42MP	12
375	33	3014SAR/1	263	3050/MS	270	3916MMP	275	42MP/B9N	12
376	33	3014SAR/2	263	3050/MV	270	3921	275	42MP/S	12
378	33	3014SAR/RR	262	3054	270	3923	275	42N/S	11
378BA	300	3023	263	3055M	270	3927	275	42N/SC9I-E	12
383	33	3025	263	3057	271	3932U	275	42N/SP25	12
383R	33	3025/PF	263	3061/2T	266	3935	275	42NEW	11
384	33	3025/RF	263	3061/2T-P50	266	3937	275	42NEWK	536
384RC	33	3025/RG	263	3061/2T-P100	266	3948	275	42SLIM	13
386A	33	3026 0,3	263	3065/20-10T	267	3952	276	42SLIM/B8NI-E	13
386A/RC	33	3026 0,5	263	3065/40-20T	267	3952/S	276	42SLIM/S11	13
386BA	300	3026 1,0	263	3067/60-15T	267	3953	276	45	13
388	33	3026/R0,3	263	3067/70-13T	267	3955	276	410	35
388A	33	3026/R0,5	263	3070B	271	3961 3,2	276	410/SEL	36
388C/C8	34	3026/R 1,0	264	3070B/10	271	3961 3,3	276	410/SP	35
389/K4	34	3026/S	264	3070BE/B	271	3961 3,5	276	410A	36
392C	34	3026/SA	264	3070BE/F	271	3961U	276	410AS	36
392RG/C	34	3026/SAM	264	3070BE/K	271	3962MV	276	410AS/SEL	36
393	34	3026/SP	264	3070BE/S	271	3962SH	276	410AS/SP	36
395	34	3027 10	264	3071A	271	3963P	276	410MIX/SEL19	36
395T	34	3027 20	264	3071B	272	3964	276	412	36
399	34	3027 30	264	3071RS	272	3965	276	412/C150	37
399R/...	34	3027 50	264	3072N	272	3965C	276	412/SP	36
3000M/LT	260	3027 100	265	3073	272	3967	276	412/SP91	37
3000M/PLM	360	3027/KP	265	3075/CM	272	3969	276	412A	37
3000M/RLS	260	3027/KPP50	265	3075/K10	272	3969K3	276	412C	37
3002	260	3027/PR	265	3075A	272	3971	277	412L	37
3002/RLS	260	3029/2T	265	3075B 55	272	3972	277	412XL	37
3003	260	3029/2T-L/R5	265	3075MV	272	3973/1	277	414	37
3003/RLS	260	3029/2T-L/R6	265	3079/21	272	3973/2	277	414/C116	38
3003C	260	3029/2T-L/RP	265	3080/C15	273	3973/3	277	414/SP	38
3003C/RLS	260	3029L/2T	265	3080R/CS3	273	3973/4	277	415	38
3003PRO	260	3030/2T	265	3081	273	3973PF	277	415/C116	38
3003PRO/PM	260	3030/2T-R5	265	3085	273	3975	277	415/SP	38
3003PRO/RCR	260	3030/2T-R6	266	3091	273	3984/1	277	415/SP91	38
3003PRO/RRG	261	3030/2TRP	266	3092	273	3984/2	277	415C	39
3003PRO/RT	261	3030H/2T	266	3093/E	273	3984/3	277	415CO	38
3003PRO/SP	260	3033/3T	266	3093/U	273	3984/4	277	415CO-A	38
3006	261	3033E/3T	266	3094PA	273	3984/5	277	415CO/SP	39
3006 R/RG	261	3033S 3T/R2	266	3099E	273	3984/6	277	415L	39
3006 R/RGF	261	3035	266	3099T	273	3991	277	416	39
3007	261	3036	266	3500/P	362	3992	277	416/SP19	39
3007 R/RG	261	3040C	269	3700-COVER C37	370	4		417	39
3007 R/RGF	261	3040C/S1	269	3700/PC	365				417/SP
3008	261	3040C/S2	269	3700/PF	365			419	39
3009	261	3041C	269	3700/PFL	365	42/B	10	419T	40
3009R/GR4	261	3041C/12	269	3700/PLA	365	42/B9N	11	420A	40
3010/T...	261	3041C/16	269	3700/PLL	365	42/SP	12	420B	40
3010H	262	3042C	269	3912PP	274	42/SP25	12	421	40
3010V	262	3043C	269	3912TP	274	42AS	12	421/SP6	40
3011/T	262	3043C/ 41÷47	269	3912TP/A	274	42AS/B9N	12	422	40
3012	262	3047C	269	3912TP/C	275	42AS/S	12	423	40
3012C	262	3048C	269	3912TP/FOX	275	42BA	298	423A	40

424	40	437K/10	46	5	5904VG/3T	467	6
424/SP	40	437K/12	46		5904VG/5T	468	
425	41	437K/16	46		5904VI/1T	429	
425/SP	41	437K/33	46		5904VI/2T	430	
426	41	437P	45		5904VI/3T	431	
426/SP	41	437U/09	46		5904VU/1M	438	
426MD-3/A9	42	437U/E-M...	46		5904VU/2M	438	
426MD-3/CP3	41	437U/PM	46		5904VU/2T	439	
426MD-3/CT3	41	438...	46		5904VU/3T	440	
426MD-3/F3	41	438A	46		5904VU/4T	441	
426MD-3/FA3	41	440	46		5905VG/1	469	
426MD-3/OG3	41	440A	47		5905VG/2	470	
426MD-3/OV3	42	440ASC	47		5908VG/2T	471	
426MD-3/S3	42	440ASF	47		5908VI/2T	432	
426MD-3/T3	42	440ASG	47		5908VU/2T	442	
426MD-3/TA3	42	440ASW	47		5910VG/3T	472	
426MD/CP	42	440B	47		5910VI/3	433	
426MD/CT	42	441	47		5910VI/3T	434	
426MD/F	42	441A	47		5914VU/M	443	
426MD/FA	42	441B	48		5915VU/0	445	
426MD/OG	42	442	48	5915VU/1	445		
426MD/OV	42	443	48	5915VU/2	446		
426MD/S	42	444	48	5915VU/3	446		
426MD/SP10	42	444G	48	5915VU/4	447		
426MD/T	42	446/C30	48	5915VU/5	447		
426MD/TA	42	446/C48	48	5915VU/AS	448		
426SB	41	446/C110	49	5927VU/M	448		
426SB/SP	41	446ASC/C37	49	5935ET/1MB	457		
426T	41	446ASF/C29	49	5935VG/1MB	473		
426T/SP	41	446ASG/C23	49	5935VI/2MB	435		
427	43	446ASW/C36	49	5938U/2T	449		
428/C14	43	447/C37	50	5940SBK	473		
428FC	43	447/C53	50	5941VU/M	474		
428FP	43	447/C70	50	5945VUM	475		
429/C14	43	450	50	5954VG	476		
429FC	43	450/C9	51	5954VI	437		
429FP	43	450/C13	51	5957U-P	450		
430	43	450/C15	51	5957VG	477		
430/SP	43	450/C21	51	5957VI	436		
430ASC	44	450AD	50	5958U	451		
430ASW	44	450AL	50	5980/MQ	459		
431	44	450PA/1	51	5980EL/A	460		
431/SP	44	450PA/2	51	5980EL/B	461		
433	44	450PR	51	5980ET/A	458		
433ASF	44	451	51	5980ET/B	459		
433ASG	44	451GA	52	5980ID	462		
434	44	451PA	52	5980U/BIKE	453		
435	45	451PR	52	5988H/7M	454		
435G	45	452	52	5988L/4M	455		
436	45	452GA	52	5988U6/M	456		
436L	45	460	52	5988U/7M	444		
436R	45	460G	52	5988 VHB-MQ	460		
437C	45	460PP	52	5990V1	452		
437C/RM14	45	4100-COVER C41H	370	5990V3	452		
437K/8	45	4900-COVER C49	374				
437K/9	45						
				5904VG/2M	464		
				5904VG/2T	465		
				5904VG/3	466		

ALPHANUMERIC INDEX

6600 M/22	555	6600 M/548	559	720L	71	730/15	76	7247BK	568
6600 M/27	555	6600 M/561	559	720L/S3	71	733/15	76	7248GK	576
6600 M/29	555	6600 M/583	559	720LC	71	7041LCD/4S	249	7249GK	576
6600 M/33	555	6600 M/643	560	720LC/C3	71	7041LCD/4S-VE	249	7293HM	584
6600 M/40	555	6600 M/650	560	720LC/PM5	71	7041LCD/4S-VI	249	7293HN	585
6600 M/42	555	6600 M/657	560	720LC/S5	71	7042LCD	249	7294HM	585
6600 M/44	555	6600 M/658	560	720LCL	71	7042LCD/RV	249	7294HMC	585
6600 M/47	555	6600 M/716	560	720LCL/C3	71	7042LCD/RV-INT	249	7294HN	585
6600 M/51	555	6600 M/813	560	720LS	71	7043	250	7310CRK	574
6600 M/52	555	6600 M/842	560	720MC	70	7051MP	601	7314AF	577
6600 M/58	555	6600 M/852	560	720MC/C13	70	7061TC	601	7315AN	577
6600 M/59	556	6600 M/856	560	720ME	72	7076BC	601	7317NA	578
6600 M/61	556	6600 M/857	560	720ME/C8	72	7076BD	601	7318AN	577
6600 M/62	556	6600 M/871	560	720MRC	72	7076BP	601	7320NA	578
6600 M/63	556	6600 M/878	561	720S	71	7076BU	601	7321NA	578
6600 M/73	556	6600 M/881	561	720S/SB6	71	7093BC	601	7322SA	578
6600 M/112	556	6800BA	602	720TC	72	7093BD	601	7323SA	579
6600 M/116	556	6800RS	602	720TC/S5	72	7104 90	601	7328EA	568
6600 M/120	556	6800 VE	554	720TX	72	7105 6	601	7328EN	568
6600 M/125	556	6888	554	720TX/C6	72	7109A	601	7340B	583
6600 M/126	556	6888B1/2	548	727/C16	73	7109D	601	7340R	583
6600 M/131	556	6888B1/4	548	727/ES16	73	7195A	601	7341N	583
6600 M/174	556	6888B3/8	548	727/ES16TX	73	7200BKK	573	7349RP	584
6600 M/175	557	6888GS	602	727/ES22	73	7201BKK	574	7350RP	584
6600 M/217	557	6888GW	602	727/ES22TX	73	7210BKK	574	7352A	579
6600 M/218	557			727/ES32	73	7216BKK	574	7352B	579
6600 M/222	557			727PI/16	73	7212FG	571	7352G	580
6600 M/223	557			727PI/22	73	7212LG	571	7352LG	580
6600 M/230	557	73	15	727PI/32	73	7213FG	571	7353Y	580
6600 M/236	557	73/B13N	15	728	73	7214FN	572	7354N	580
6600 M/241	557	73/S	15	728/15	74	7214LN	572	7355V	581
6600 M/242	557	78	15	728/15	74	7215FN	572	7356G	581
6600 M/253	557	78AS	15	728/16	74	7217FG	572	7356LN	581
6600 M/311	557	78BA	298	728/21	74	7218FN	573	7356V	581
6600 M/315	557	78BA-AS	299	728/22	74	7219FY	573	7357G	582
6600 M/320	558	710	69	728/22L	74	7220PEK	569	7357V	582
6600 M/326	558	710/16	69	728/25	74	7221PEK	569	7362B	582
6600 M/327	558	710/20	69	728/C10	74	7222PEK	569	7363N	582
6600 M/330	558	710/21	70	728/OR - 728/SP	74	7223PEK	570	7398 0/G	586
6600 M/371	558	710/25	70	728AS	74	7224PEK	570	7398EF	586
6600 M/380	558	710/C10	69	728FTX	74	7225PEK	570	7398GEL	586
6600 M/406	558	710/OR... - 710/SP...	70	728L	74	7235BK	575	7398T	586
6600 M/417	558	720	70	728L/S	74	7236BK	575	7398U	586
6600 M/423	558	720/15	72	728LQ	74	7238WR	575	7398UP	586
6600 M/424	558	720/16	72	728LS	74	7239B	576	7399 A/N...	586
6600 M/427	558	720/20	72	729	75	7241BK	566	7421	586
6600 M/430	558	720/21	72	729/15	75	7241CK	566	7423	586
6600 M/440	559	720/25	72	729/16	75	7241EN	565	7425	586
6600 M/456	559	720/C6	70	729/21	75	7243BK	566	7427	586
6600 M/465	559	720/C12	70	729/22	75	7243CK	567	7429	586
6600 M/480	559	720/C24	70	729/25	75	7243CR	567	7431P	586
6600 M/485	559	720/OR... - 720/SP...	73	729/OR... - 729/SP...	75	7243EN	565	7525	588
6600 M/510	559	720AS	70	729L	75	7243FT	567	7528	588
6600 M/532	559	720FTX	72	729LS	75	7245BK	567	7529	592
6600 M/534	559	720FTX/SB	72	729T	75	7246BK	568	7547BL	599
6600 M/542	559	720IC	71	730	75	7246E	565	7547G	599

ALPHANUMERIC INDEX

7547N	599	7903G	593	860PH	76	882MSR	82	8029R	611
7549BL	599	7903P	593	860PHZ/A10	77	882P	82	8029R-K	611
7549G	599	7904N	597	860PZ	76	892	82	8031R	611
7549N	599	7905G	594	860RTX	77	895	83	8031R-K	611
7557BL	599	7907G	596	860TX	77	897	83	8032	611
7575N	595	7907P	596	860TX/A10	77	897L	83	8032-K	611
7579T	595	7909B	594	861/C61P	79	8001TZ	607	8040EN	614
7634B	597	7909G	594	861LP	78	8001TZ-K	607	8040EN-K	614
7634G	597	7909P	594	861PE	78	8001Z	606	8040EZ	614
7635N	598	7909V	595	861PH	78	8001Z-K	606	8040EZ-K	614
7650	588	7930G	591	861PH/C	78	8002ZD	607	8041	613
7650B	588	7931G	592	861PZ	78	8002ZS	607	8041-K	613
7654B	598	7933G	593	861PZ/C	78	8003ZD	607	8042EN	615
7654N	598	7935G	594	861RIBE	79	8003ZS	607	8042EN-K	615
7657B	598	7939G	595	861RTX	78	8004ND	607	8042EZ	615
7657N	598	7940	591	861SP	79	8004NS	607	8042EZ-K	615
7658CM	596	7949	595	861TQS	79	8005TZ	605	8043	614
7658N	596	7970	599	861TRW	79	8005TZ-K	605	8043-K	614
7659N	596	7971L	600	861TX	78	8005Z	604	8044	615
7660B	588	7978L	600	861TX/C	78	8005Z-K	605	8048	608
7660G	589	7979	600	861XZN	79	8006Z	605	8049	612
7661B	592	7980N	600	862F	80	8006Z-K	605	8049A	613
7661G	592	7980NC	600	862F/A7	80	8007Z	605	8049V	613
7664G	598	7980R	600	862LP	79	8007Z-K	605	8050 D	627
7664N	598	7984EG	601	862PE	80	8008N	605	8051S	622
7665G	598	7984G	601	862PH	79	8008N-K	605	8051S-K	622
7665N	598	7985	601	862PH/L	79	8008TZN	606	8052 - 8055S	621
7669N	596	7996N	600	862PH-XL	79	8009FD	608	8057	621
7670G	597			862PZ	79	8009FS	608	8057R - 8057	621
7673NG	595			862TX	80	8009TZ	606	8058R - 8058	620
7674NG	597			862TX/L	80	8009TZ-K	606	8058R/PS	627
7780T	597			862TX-XL	80	8009Z	606	8060R - 8060	620
7800G	600			866LP	80	8009Z-K	606	8060R/PS	627
7810	589			866PE	80	8010TZ	606	8061F	620
7812	589			866PH	80	8010Z	606	8061R - 8061F	620
7813	592			866PZ	80	8010Z-K	606	8062	622
7816BL	589			866RTX	80	8015	609	8063	621
7816G	589			866TX	80	8016	609	8063SL	621
7817N	590			867/...	81	8016FR	609	8064S	621
7819B	590			867/C20	81	8016FR-K	609	8065SC	621
7830ST	590			867/C38	82	8016-K	609	8074	624
7831ST	592			867/C52	82	8016U-K	610	8074A	624
7840BL	590			867PE	81	8016U2	610	8074G	624
7849BL	594			867PE/L	81	8016UGK	610	8080	624
7860G	590			867RIBE	81	8018E	610	8080FM	624
7861G	592			867RIBE/L	81	8018T	610	8082	625
7863G	593			867RTX	81	8020A	610	8083	625
7865G	593			867RTX/L	81	8021	610	8085	620
7867G	595			867TX	81	8025	611	8085R	620
7869G	594			867TX/L	81	8025-K	612	8086	620
7880SC	590			867XZN	81	8026A	612	8090F	637
7900B	591			867XZN/L	81	8026A-K	612	8009FS	629
7900G	591			882	82	8026R	611	8090R - 8090	620
7900P	591			882AN	82	8026R-K	611	8091	616
7900V	591			882M	82	8028	612	8091SL	616
7901G	592			882M1	82	8028-K	612	8092	616

8

ALPHANUMERIC INDEX

8092SL	617	8180	637	8279	633	9	96C/AS	19
8094	617	8181	637	8280	632		96L	20
8094SL	617	8181S	637	8282S	632		96L/SC12	20
8096	618	8182	637	8284	632		96L/SP8	20
8096SL	618	8182A	638	8285	632		96LBP	20
8097	618	8182E	638	8286	633		96LBP/SC9	20
8097SL	619	8182H	637	8287	633		96LC	19
8098	619	8182S	638	8290	633		96LC/SC8	20
8098SL	619	8182T	637	8293	633		96LC/SC12	20
8100	622	8182TS	637	8297C	633		96N	18
8105	604	8183	638	8297F	633	96N/B	19	
8105-K	604	8184	638	8302Z	608	96N/G	19	
8109	604	8185	638	8303Z	608	96N/SC9	19	
8109-K	604	8186	638	8317DZ	625	96N/SC12	19	
8110	604	8187	639	8317SZ	625	96N/ST	19	
8114	625	8188C	639	8381SL	625	96N/ST6K	536	
8116	625	8188CG/25	639	8381SP	625	96T	21	
8120	623	8188CU/25	639	8381SX	633	96T/AS	21	
8120B	624	8188F	639	8383C	626	96T/S6	21	
8120D	624	8188F35	639	8383P	626	96T/S11	21	
8120DZC	624	8188VFG2	639	8515CH	626	96T/SP	21	
8129	624	8189	639	8515V	626	96T/SPV	505	
8130	626	8189A	639	8515Z	626	96TAS/S	21	
8130A	626	8189PA	639	8531	626	96TBP	22	
8131DL	626	8190	638	8532	626	96TBP/S6	22	
8131Z	626	8190B	638	8535	626	96TK	537	
8135	623	8201T	629	8600 R/11	561	96FTX	17	
8135/KGF	627	8205	628	8600 R/12	561	96FTX/S	17	
8135/KGM	628	8206	628	8600 R/13	561	96	18	
8135/KLA	628	8207	628	8600 R/113	561	96/B	18	
8139DL	627	8209	628	8600 R/114	561	96/BG7	18	
8139Z	627	8210	629	8600 R/225	561	96/BGS7	18	
8139ZCH	627	8210F	629	8600 R/412	561	96/SC9	18	
8143	622	8216	629	8600 R/511	561	96/SC12	18	
8143/RK	627	8216-K	629	8600 R/601	561	96/ST	18	
8146	623	8220	629	8600 R/611	561	96/ST6K	536	
8146/RK	627	8225	630	8702N	608	96AS	19	
8146C	623	8227	630	8702Z	608	96AS/B	19	
8149CM	628	8228	630	8702ZC	608	96AS/BG7	19	
8149S/A	623	8240	630	8709N	609	96AS/G	19	
8150	634	8240F	630	8709Z	609	96AS/SC9	19	
8153	634	8242	631	8709ZC	609	96AS/T	19	
8156	634	8242F	630	8889C1	503	96BA	299	
8157	634	8248	629	8889C2	503	96BA/BP	299	
8158	634	8249	629	8889C3	503	96BAF-AS	300	
8159	635	8249G	629	8889C6	504	96BP	20	
8160	635	8250	632	8889CD	504	96BP-CL	20	
8161	635	8264	632	8889CS	504	96BP-CL/SC9	20	
8166	637	8267	632	8889I4	504	96BP/AS	21	
8170	635	8272	632	8889P1	503	96BP/AS-SC9	21	
8173	635	8273	632	8889P2	503	96BP/ASB	21	
8176	635	8274	631	8889P3	503	96BP/SC9	20	
8177	635	8274A	631	8889P4	504	96BPA	21	
8178	636	8274G	631	8889PD	504	96BPA/SC9	21	
8179A	636	8276	631	8889PS	504	96BPC	20	
8179B	636	8276G	631			96BPC/SC9	20	
8179M	636	8278	631			96C-AS/SC9	19	
						96C/AS	19	
						96L	20	
						96L/SC12	20	
						96L/SP8	20	
						96LBP	20	
						96LBP/SC9	20	
						96LC	19	
						96LC/SC8	20	
						96LC/SC12	20	
						96N	18	
						96N/B	19	
						96N/G	19	
						96N/SC9	19	
						96N/SC12	19	
						96N/ST	19	
						96N/ST6K	536	
						96T	21	
						96T/AS	21	
						96T/S6	21	
						96T/S11	21	
						96T/SP	21	
						96T/SPV	505	
						96TAS/S	21	
						96TBP	22	
						96TBP/S6	22	
						96TK	537	
						96FTX	17	
						96FTX/S	17	
						96	18	
						96/B	18	
						96/BG7	18	
						96/BGS7	18	
						96/SC9	18	
						96/SC12	18	
						96/ST	18	
						96/ST6K	536	
						96AS	19	
						96AS/B	19	
						96AS/BG7	19	
						96AS/G	19	
						96AS/SC9	19	
						96AS/T	19	
						96BA	299	
						96BA/BP	299	
						96BAF-AS	300	
						96BP	20	
						96BP-CL	20	
						96BP-CL/SC9	20	
						96BP/AS	21	
						96BP/AS-SC9	21	
						96BP/ASB	21	
						96BP/SC9	20	
						96BPA	21	
						96BPA/SC9	21	
						96BPC	20	
						96BPC/SC9	20	
						96C-AS/SC9	19	
						96C/AS	19	
						96L	20	
						96L/SC12	20	
						96L/SP8	20	
						96LBP	20	
						96LBP/SC9	20	
						96LC	19	
						96LC/SC8	20	
						96LC/SC12	20	
						96N	18	
						96N/B	19	
						96N/G	19	
						96N/SC9	19	
						96N/SC12	19	
						96N/ST	19	
						96N/ST6K	536	
						96T	21	
						96T/AS	21	
						96T/S6	21	
						96T/S11	21	
						96T/SP	21	
						96T/SPV	505	
						96TAS/S	21	
						96TBP	22	
						96TBP/S6	22	
						96TK	537	
						96FTX	17	
						96FTX/S	17	
						96	18	
						96/B	18	
						96/BG7	18	
						96/BGS7	18	
						96/SC9	18	
						96/SC12	18	
						96/ST	18	
						96/ST6K	536	
						96AS	19	
						96AS/B	19	
						96AS/BG7	19	
						96AS/G	19	
						96AS/SC9	19	
						96AS/T	19	
						96BA	299	
						96BA/BP	299	
						96BAF-AS	300	
						96BP	20	
						96BP-CL	20	
						96BP-CL/SC9	20	
						96BP/AS	21	
						96BP/AS-SC9	21	
						96BP/ASB	21	
						96BP/SC9	20	
						96BPA	21	
						96BPA/SC9	21	
						96BPC	20	
						96BPC/SC9	20	
						96C-AS/SC9	19	
						96C/AS	19	
						96L	20	
						96L/SC12	20	
						96L/SP8	20	
						96LBP	20	
						96LBP/SC9	20	
						96LC	19	
						96LC/SC8	20	
						96LC/SC12	20	
						96N	18	
						96N/B	19	
						96N/G	19	
						96N/SC9	19	
						96N/SC12	19	
						96N/ST	19	
						96N/ST6K	536	
						96T	21	
						96T/AS	21	
						96T/S6	21	
						96T/S11	21	
						96T/SP	21	
						96T/SPV	505	
						96TAS/S	21	
						96TBP	22	
						96TBP/S6	22	
						96TK	537	
						96FTX	17	
						96FTX/S	17	
						96	18	
						96/B	18	
						96/BG7	18	
						96/BGS7	18	
						96/SC9	18	
						96/SC12	18	
						96/ST	18	
						96/ST6K	536	
						96AS	19	
						96AS/B	19	
						96AS/BG7	19	
						96AS/G	19	
						96AS/SC9	19	
						96AS/T	19	
						96BA	299	
						96BA/BP	299	
						96BAF-AS	300	
						96BP	20	
						96BP-CL	20	
						96BP-CL/SC9	20	
						96BP/AS	21	
						96BP/AS-SC9	21	
						96BP/ASB	21	
						96BP/SC9	20	
						96BPA	21	
						96BPA/SC9</		

ALPHANUMERIC INDEX

900/25	86	900MC/PH	85	910ASL/SB12	92	920/21K	539	920B	97
900/25K	538	900MC/TX	86	910B	91	920AK	539	920B/C11	103
900/32	87	900ME	86	910B/C10	95	920/25	101	920B/C12	103
900/35A	87	900ME/SB8	86	910B/C16	96	920/25K	539	920B/C12X	103
900/40	87	900PE/AS	86	910B/C16Q	96	920/35A	101	920B/C20	103
900/42	87	900PH	85	910B/C29	96	920/36A	101	920B/C20X	104
900/55	87	900PH/SB4	85	910B/SB	91	920/38	101	920B/C21	104
900/55K	538	900PT	86	910B/SN	92	920/40	101	920B/C21X	104
900/55Z	87	900PZ	85	910BL	92	920/42	101	920B/C30Q	104
900/55ZK	538	900T/44	87	910BL/SB	92	920/44	101	920B/C33	104
900/58	88	900TX	86	910BP	93	920/46	101	920B/SB8	97
900/58K	538	900TX/SB	86	910BP/SB6L	93	920/50	102	920B/SB13	97
900/C11	88	900U	85	910CF	94	920/50F	102	920BL	97
900/C11HR	91	900U/C12M	90	910CF/SB	94	920/55	102	920BL/SB11	97
900/C11Z	88	900U/SB	85	910FTX	92	920/55K	539	920BP	99
900/C12MR	88	902A/C22	91	910FTX/L	93	920/55L	102	920BP/SB	99
900/C12MZ	89	902R/C6	91	910FTX/LSB	93	920/55LC	102	920ES	100
900/C13-5	89	910/R55	108	910FTX/SB	92	920/55Q	102	920ES/SB	100
900/C13-8	89	910/R55Q	108	910FTX/XL	93	920/55X	102	920ES/XL-SB	100
900/C24	89	910/R55X	109	910FTX-XL/C10	93	920/56A	102	920FTX	98
900/C39N	88	910/15	94	910LP	93	920/58	102	920FTX/C	98
900/C39U	88	910/16	94	910M/35	94	920/58K	539	920FTX/L	98
900/R55	108	910/20 - 910/21 - 910/22	94	910M/55	95	920/C37	105	920FTX/LSB	98
900/R55-Z	108	910/21K	539	910M/56	95	920/R50	109	920FTX/SB	98
900/SB	84	910/25	94	910M/R55	108	920/R55	109	920LH/SB7	99
900AN	86	910/25K	539	910ME	93	920/R55LC	109	920LP	99
900AS	84	910/36A	95	910ME/SB	93	920/R55Q	109	920M/35	101
900AS/C10	90	910/40	95	910MQ/21	280	920/R55X	109	920M/35L	101
900AS/C17-MBM	90	910/42	95	910MQ/22	280	920A	97	920M/55	102
900AS/L	85	910/46	95	910MQ/55	281	920A-AS/SB11	98	920M/56	102
900AS/MB	84	910/55	95	910MQ/B	280	920A/AS	98	920M/R55	109
900AS/MB-C17	90	910/55K	539	910MQ/C16	281	920A/C11	103	920MC	97
900AS/MBL	85	910/55Q	95	910MQ/PE	280	920A/C12	103	920MC/C14	103
900AS/SB11	84	910/58	95	910MQ/PT	280	920A/C12X	103	920ME	99
900BG/30	87	910/58K	539	910MQ/T	281	920A/C17HR	106	920ME/C	100
900BG/30C	87	910A	91	910MQ/TX	280	920A/C17M	105	920ME/SB	100
900BG/30K	538	910A-AS/SB13	92	910MQ/XZN	280	920A/C17MR	105	920MQ/21	281
900FL	86	910A/AS	92	910PE	93	920A/C20	103	920MQ/22	281
900FTX	85	910A/C10	95	910PE/AS	93	920A/C20Q	103	920MQ/55A	281
900FTX/SB9	85	910A/C16	95	910PE/SB	93	920A/C20X	103	920MQ/A	281
900K	538	910A/C16HR	96	910PH	93	920A/C21	104	920MQ/C16	282
900L	84	910A/C16Q	95	910PH/SB4	93	920A/C21X	104	920MQ/PE	281
900L/SB	84	910A/C17	96	910PT	94	920A/C33	104	920MQ/T	281
900LP	85	910A/C29	96	910PT/SB	94	920A/SB8	97	920PE	99
900M/35	87	910A/SB	91	910TX	94	920A/SB13	97	920PE-AS/SB6	99
900M/55	88	910AK	539	910TX/SB	94	920AL	97	920PE/AS	99
900M/R55	108	910AL	91	910XZN	94	920AL/SB11	97	920PE/C	99
900MB	84	910AL/SB14	91	911BA	300	920AN	101	920PE/SB	99
900MB/C19	89	910AN	94	911BA/16	300	920AS	98	920PH	99
900MB/C28	89	910AS	92	911BA/20	300	920AS/C10	105	920PH/SB4	99
900MB/L	84	910AS/C13	96	911BA/55	300	920AS/C15	105	920RTX	100
900MB/SB	84	910AS/L	92	914MQ/A	281	920AS/C17X	105	920RTX/SB	100
900MC	84	910AS/MBM-C18	96	914MQ-A/S4	281	920AS/L	98	920TX	100
900MC/C24	90	910AS/SB13	92	920/15	101	920AS/MBM-C21	105	920TX/C	100
900MC/C32	90	910AS/SN	92	920/16	101	920AS/SB11	98	920TX/C17	106
900MC/LP	85			920/20+920/23	101	920ASL/SB11	98	920TX/L-SB4	100

ALPHANUMERIC INDEX

920TX/SB	100	935	110	957	115	962	120	996	124
920U	98	935/S	110	959	115	962C	120	998	124
920U/C17M	106	935K	539	959R	115	962M	120	999	124
920U/SB4	98	937	110	960	115	962P	120	999/B6N	125
920U/SB13	98	937/S	110	960/22EP	118	963	120	999A	124
920XZN	100	937BA	302	960/C6	118	963BA	302	999B	124
920XZN/LS	100	937K	539	960/D	118	964	121	999C	125
920XZN/SB7	100	940	110	960A	115	964BA	302	999D	125
920XZN/SB12	100	941	110	960AD/TP2	174	964BA/L	302	999E	125
921BA	301	941/S	110	960AVE	118	965	121	999G	125
921BA-AS	301	942BX	111	960AVL	120	965/S	121	9500TL	641
921BA/15	301	942BX/DG	550	960BC	116	965BA	302	9501TL	641
921BA/16	301	942BX/S	111	960BC/C5	116	966/C3	121	9501TLD	641
921BA/21 - 921BA/22	301	943BX	111	960BC/P 28	116	966BA	302	9502TL	642
921BA/25	301	943BX/D	111	960BT/B	116	966BA/V	302	9503TL	642
921BA/42	301	943BX/DG	550	960CMB	118	969/C5	121	9504TL	642
921BA/50	301	943BX/S	111	960CMB/R2	118	969B	121	9505TL	642
921BA/R50	301	943BXK	539	960CMD	118	970B	121	9508TL	642
926BA	301	943FL	111	960CMD/R1	118	970C	121	9510W	642
926BA/15	301	943FL/S	111	960E-PI/P	119	970EA	121	9515M	645
926BA/22	301	943MQ	282	960EPC	118	970EB	121	9516B	645
926BA/42	301	943MQ/BG	550	960EPC/L	119	970IVECO	121	9521	644
926BA/50	302	943MQ/S	282	960ER	116	970OT	122	9521OB	644
926BA/R50	302	944BX	111	960F	116	970Q	121	9522A	649
928.../C12	107	944BX/D	111	960G	116	971/C8	122	9523A	649
928/15	107	944BX/DG	550	960H/C4	116	972/C4BMW	122	9523T	646
928/16	107	944BX/S	111	960KC-M8/M9/M10	119	972/C10	122	9524SC	646
928/20 - 928/21 - 928/22	107	949	111	960KPC	119	973	122	9525/B	644
928/25	107	949/S6	112	960L	116	978 - 979	122	9525F	644
928/36A	107	950	112	960M	116	982	122	9525TL	644
928/42	107	950/S	112	960P	119	983PM	122	9526P	649
928/55	107	951	112	960PI	119	984	122	9526RMN	649
928/R55	109	951/S	112	960PI/C19	119	985/B7	122	9527 6T	649
928/R55X	109	951/SP	112	960PI/S	119	985F	123	9527MUG	649
928A	106	951AS	113	960PMC	120	985M	123	9528B	646
928AS	106	951AS/S	113	960RPI	120	986 48	123	9534BO	642
928AS/C12	107	951BA	302	960S	116	986 78	123	9534WO	642
928B	106	951K	539	960SL	116	986PT	123	9537TL	643
928B/C12	107	951MQ	282	960SN	116	987	123	9539CB	645
928ME	106	951TX	113	960T/A	117	987AR	123	9541BIKE	644
929	108	951TX/S	113	960T/B	117	987P	123	9541F	644
929/15	108	952	113	960T/C	117	988/K4	123	9541S	644
929/21 - 929/22	108	952/S	113	960T/C11	117	989	123	9542AL	646
929/42	108	952AS	114	960T/D	117	989A	123	9542AT	646
929/55	108	952FTX	114	960T/E	117	989B	123	9542C	645
929/55PR	108	952FTX/S	114	960T/F	117	990	124	9542G	646
929/C8	108	952L	114	960T/G	117	991	124	9542GW	645
929/R55	109	953	114	960T/H	117	992	124	9542M	645
930	109	953/S	114	960T/I	117	993	124	9542S	646
930/C	109	953TX	114	960T/L	117	993G	124	9543C	646
930/S	109	953TX/S	114	960T/M	117	993MQ	282	9544C	643
932	109	955	115	960UC	119	993PL	124	9547	649
932/S	110	956C	115	960YP	118	994	124	9547T	647
933	110	956E	115	961BA	302	994MQ	282	9547WSK	647
933/S	110	956F	115	961P6	120	994PL	124	9548G	647
		956L	115	961P6/S	120	994TF	124	9548KB	647

ALPHANUMERIC INDEX

9548KB 20	647	9595C	650	C39T	369	C55	389	C55RB	396	
9548KB 24	647	9595T	650	C41H	372	C55/1PF	405	C55STR	411	
9549ABW	649	9596	650	C41H/CE	372	C55/2PM	404	C55T3	402	
9549BP	649	9597P	646	C41S	372	C55/PF	403	C56	383	
9549C	649	9598W-N	645	C42H	373	C55A1	409	C56B	383	
9557J 2.0	643	9598WHP-N	645	C43	373	C55A1/R42	409	C56M	384	
9557J 3.0	643	9599CB-N2	644	C45LMP	426	C55A2	410	C56W	383	
9557N	644	9599CB-W	644	C45PRO ACT	422	C55A2/R70	410	C57SA	380	
9559	647	C		C45PRO AS1	425	C55AB	390	C57SB	381	
9559/30MT	647			C45PRO AS2	425	C55AC	407	C57SC	381	
9561V	647		C04TSS-7	357	C45PRO AW	413	C55AE	406	C57SD	380
9561V 2,5	647		C3	336	C45PRO AX	413	C55AT1	411	C57SP	382
9561VV	647		C4 - 2104	336	C45PRO BPW-1,3	417	C55AT2	411	C58B	384
9561VV 2,5	647		C5 - 2105	336	C45PRO BPW-2,0	417	C55B PT/2	396	C58M	384
9562P2	651		C5S	336	C45PRO BPX-1,3	416	C55B PT/2,8	396	C58M/PA	384
9562P12	651		C6T - 2106	336	C45PRO BPX-2,0	417	C55B/1	408	C58P	382
9562T1	270, 651		C7 - 2107	337	C45PRO BW	414	C55B/2	391	C59A	385
9562T2	386, 651		C8 - 2108	337	C45PRO BX	414	C55B/2,8	392	C59B	386
9562T3	270, 651	C8B	337	C45PRO C7	420	C55B-D4	393	C59C	386	
9562TB	602, 651	C9 - 2109	337	C45PRO C/W	424	C55B/G	394	C62M/W	602	
9563G	648	C9/RT	337	C45PRO C/X	424	C55B/GAA	394	C64/1	602	
9563U	648	C10 - 2110	337	C45PRO CW	416	C55B/GAE	395	C64CW	602	
9565BBQ	648	C10S - 2110S	337	C45PRO CX	416	C55B/GDP	394	C64G/1	602	
9565ICE	648	C11 - 2111	338	C45PRO DX	414	C55B/GDS	394	C68	553	
9565K	648	C12 - 2112	338	C45PRO DW	415	C55B/GE	395	C68 G	553	
9565S	602	C13	338	C45PRO EW	415	C55B/VS	396	C88 R/1	554	
9565T	648	C14	338	C45PRO EX	415	C55C	408	C88SE	554	
9569MS	650	C16 - 2116	339	C45PRO M4	420	C55C7	397	C88VE	554	
9569MS-2	650	C18 - 2118	339	C45PRO M5	420	C55C8	398	C99	341	
9569P	650	C19 - 2119 - C19L	339	C45PRO M7	421	C55CS	400	C99C-V3	344	
9569S	650	- 2119L	339	C45PRO M7A/W	418	C55KAI	407	C99M	345	
9572LB	642	C20 - C20L - 2120	339	C45PRO M7A/X	418	C55KAS	407	C99P	344	
9574B	644	C20TSS	340	C45PRO MA	421	C55M2	398	C99P-V3	345	
9574O	644	C22B	340	C45PRO ML	422	C55M4	399	C99P12-V0	342	
9577M	648	C22P	340	C45PRO MS	421	C55M7	399	C99PC	345	
9579C	648	C22W	340	C45PRO PA	423	C55M8	400	C99PP	345	
9580S	643	C25	357	C45PRO PF	423	C55MA	401	C99T	345	
9586K	649	C27S	358	C45PRO PFE	424	C55MDO	401	C99T-V3	345	
9587 9x14	650	C30M	360	C45PRO PM	425	C55MP	407	C99V0	341	
9587 13x21	650	C35/6G	361	C45PRO SL	423	C55MS	402	C99V0-P12	342	
9588/10PI	651	C35/7G	362	C45PRO SS	423	C55PB/3	390	C99V1	343	
9588M	650	C35/8G	362	C45PRO TC	422	C55PFA-1,0	403	K		
9588S/10...	650	C35/9G	362	C45PRO W	413	C55/PL-1,024	396		KIT/GPS	496
9589A/36	651	C37/7	363	C45PRO X	412	C55PM	403	M		
9589B/36	651	C37/6	364	C45PW/1-0,7MT	419	C55P/2MDX-SX	403		M01	479
9590B	647	C37/8	364	C45PW/2-1,3MT	419	C55P/MCD	403	M02	479	
9592B/C50	649	C37A/7	364	C45PW/3-2,0MT	419	C55PFA-0,8	405	M05	479	
9592B/P	649	C38	366	C45PX/1-0,7MT	419	C55PM/M0,8	405	M06	479	
9592M/50	649	C38C	367	C45PX/2-1,3MT	419	C55PRO B/2	391	M13	479	
9592MB	649	C38L	366	C45PX/3-2,0MT	419	C55PRO B/2,8	392	M25	479	
9593A	643	C38L A	366	C48M	375	C55PRO B-D4	393	M30	479	
9593M	643	C38T	367	C48P	375	C55PS	406	M31	479	
9593S	643	C39/6	369	C50S	376	C55PSE	406	M33	479	
9593SB	643	C39/7	368	C51	376	C55PT0,8x0,6	405	M38	479	
9593W	643	C39/8	369	C56P O	378	C55PT1,0x0,6	404			
9594	649	C39MD	371	C56PL O	378	C55PTE-0,8	405			
9595 C25	650	C39SM	371	C54S	379	C55PTE-1,0	404			

ALPHANUMERIC INDEX

M39	480	M208	486	R	T59	495	T183	499			
M40	480	M209	486		T63	495	T198	499			
M44	480	M213	486		T64	495	T199	500			
M45	480	M214	486		RSC22	346	T65	495	T201	500	
M46	480	M216	486		RSC23	347	T68	495	T202	500	
M49	480	M217	487		RSC23C	347	T73	495	T204	500	
M50	480	M218	487		RSC23T	348	T75	495	T205	500	
M52	480	M219	487		RSC24/5	350	T76	495	T206	500	
M53	480	M222	487		RSC24/6	350	T77	495	T207	500	
M55	480	M226	487		RSC24/7	349	T79	495	T208	500	
M60	481	M227	487		RSC24/8	350	T80	496	T209	500	
M62	481	M230	487		RSC24A/6	351	T81	496	T211	500	
M63	481	M231	487		RSC24A/7	351	T81	496	T213	500	
M65	481	M234	487		RSC24A/8	351	T82	496	T216	500	
M69	481	M236	487	RSC24AXL/7	352	T83	496	T221	501		
M75	481	M237	488	RSC24AXL/8	353	T85	496	T226	501		
M78	481	M240	488	RSC24AXL/9	353	T91	496	T227	501		
M79	481	M264	488	RSC24L-CAB	356	T92	496	T228	501		
M82	481	M284	488	S	T99	496	T231	501			
M83	482	M285	488		T100	496	T233	501			
M85	482	M289	488		S42/17	505	T101	496	T234	501	
M86	482	M292	488		S55/8	504	T102	496	T236	501	
M91	482	M295	488		S55/12	504	T103	497	T239	501	
M92	482	M305	488		S96T/8	505	T105	497	T241	501	
M94	482	M310	488		S951/6	505	T105	497	T250	501	
M96	482	MB	504		S952/10	505	T106	497	T256	501	
M100	482	MB12	489		S1719BM	505	T110	497	T259	502	
M105	483	MB37	489		SB	504	T112	497	T264	502	
M108	483	MB38	489		SGN	505	T113	497	T270	502	
M110	483	MB39	489		SPC	426	T121	497	T273	502	
M112	483	MB44	490		SPG11 - S1203/8	505	T123	497	T281	502	
M115	483	MB45	490		ST2P	504	T124	497	T284	502	
M120	483	MB46	490	T	T135	497	T285	502			
M121	484	MB47	490		T136	497	T289	502			
M125	484	MB56	490		T137	497	T291	502			
M126	484	MB58	490		T01	493	T138	498	T297	503	
M127	484	MB59	490		T05	493	T140	498	V		
M128	484	MB63	491		T06	493	T144	498		VE1	504
M129	484	MB64	491		T13	493	T145	498		VP1 - VP2	503
M133	484	MB65	491		T18	493	T146	498		VP3 - VP4	503
M134	484	MC10	489		T19	493	T151	498		VP-3SC	503
M135	484	MC12	489		T22	493	T153	498		VP5	503
M136	484	MC20	489		T23	493	T156	498		VP6	503
M137	485	MC21	489		T31	494	T157	498		VP-LD	503
M145	485	MM11	491		T33	494	T160	498		VP-LS	503
M153	485	MM61	491		T34	494	T161	498		VPM0	492
M161	485	MM105	492	T40	494	T164	498	VPM3		492	
M162	485	MM140	492	T41	494	T167	499	VPM7		492	
M166	485	MM210	492	T45	494	T168	499	VPM7-C		492	
M170	485	P		T46	494	T170	499	VPM8		492	
M172	485				T48	494	T171	499	VPM9	492	
M174	485				T50	494	T172	499			
M180	485		PM 1/2-Q5	71	T52	494	T173	499			
M195	486	PM 1/2-Q5	100	T53	494	T175	499				
M199	486	PM/5C	426	T55	494	T176	499				
M202	486	PM/6C	426	T56	495	T177	499				
M204	486	PV	382	T57	495	T180	499				

LOGISTICS



22.000 m²
surface area



15.000
coded items
and over **27.000**
loading units



Quick, prompt
and complete
deliveries



WORLDWIDE DISTRIBUTION



Active in over
100 countries
worldwide

**Beta's
far-reaching
distribution
network**
serves
professional users
across the world.



111

Subsidiaries

THE HISTORY OF ITALIAN TOOLS

- 1923** ● Alessandro Ciceri founded “Alessandro Ciceri & Figli”, to manufacture iron and steel casts.
- 1939** ● The trademark Beta was registered and the Company became involved mainly in manufacturing professional tools.
- 1960** ● Beta Utensili employed two hundred people, exported their products and stood out as an up-and-coming manufacturer of professional tools.
- 1969** ● The revolutionary orange sheet metal “Tank” trolley was developed; from that moment orange would result in a unique style for the trademark Beta.
- 1971** ● Beta Utensili entered the motor racing world, with a view to testing and developing their products.
- 1975** ● The Company scored their first Formula 1 victory with the orange **March-Beta Utensili** driven by Vittorio Brambilla, who won the Austrian Grand Prix in Zeltweg, in the pouring rain.
- 1980** ● Beta Utensili further penetrated the main European markets, progressively establishing branches in France, Britain, Holland, Spain, Poland and Hungary.
- 1995** ● It took the Company no more than 8 months to have their Quality System certified in accordance with the ISO 9001 standards.
- 2000** ● The launch of the new Beta Utensili catalogue testified to ongoing growth. The range of available products was doubled, and the over 10,000 coded items were divided into 22 product families.
- 2002** ● Beta Utensili’s range was further expanded, being supplemented with safety footwear as well as with work and free-time wear, namely the “Beta Work” range.
- 2009** ● Beta further expanded their markets, establishing Beta China.
- 2012** ● Beta Brazil was founded.
- 2016** ● Beta introduces a new modular workshop equipment combination system.
- 2018** ● **BM** BM S.p.A - leader in the production and sales of crimping terminals and electric connection systems - becomes part of the Beta Group.
- 2019** ● Beta Utensili took over **Abra Beta S.p.A**, a market leader in the production of resin bond reinforced abrasives for grinding and cutting all types of materials and shaft-mounted wheels.
- 2020** ● Beta Utensili took over the leading manufacturer of flexible abrasives, **Elpa Abrasivi S.r.l.**, thereby creating a national skills centre and successfully entering the abrasives market with a new, comprehensive range of professional items. The **Beta Tools USA** branch was established, as a major step towards expansion in the North American market.
- 2022** ● Ongoing growth has translated into the current product range – distributed worldwide –, which exceeds **15,000 coded items**, designed to satisfy the most demanding professionals’ requirements.



1939 Forging department



1950 Galvanising department



1955 Shearing department



1960 Shipping warehouse



1969 Tank trolley

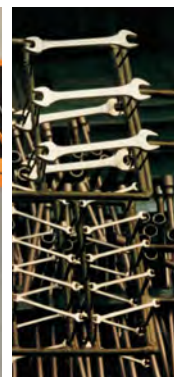

1975 Chrome finishing



1974 Vittorio Brambilla



1980 Engineering department



2002 “BetaWork”



2021 Tour de France



2021 Sam Lowes

CERTIFIED QUALITY

In 2018 Beta roller cabs were awarded prestigious **Tüv** certification, after passing severe tests according to protocol EK5/TA5.

Protocol EK5/TA5 deals with 31 well-defined building characteristics, stringent static tests and dynamic behaviour tests. Other tests determine resistance to high and low temperatures, the service life of markings over time and corrosion resistance.

Credit for this achievement is due to the expert design, accurate manufacture and stringent tests Beta relies on for its roller cabs, which has allowed their quality to be acknowledged by end users.



CONTROL AND QUALITY

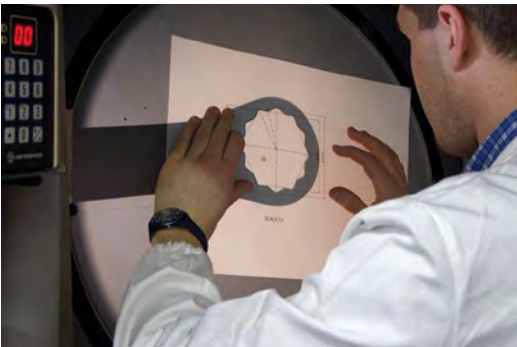
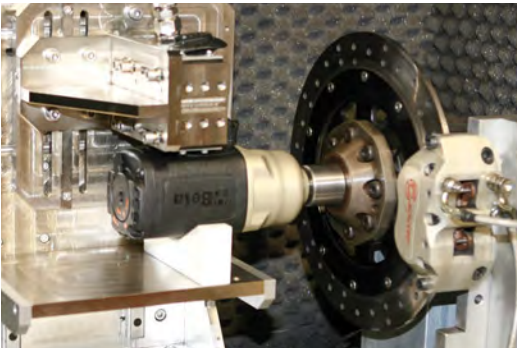
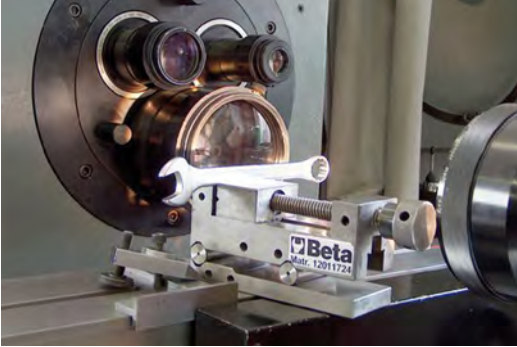

At Beta, quality has a simple, concrete meaning: “that which fully satisfies the needs and expectations of the professional users who rely on our products as an irreplaceable working instrument”. Tools are not only designed and manufactured correctly to fulfil a need, but they must guarantee repeat performances consistently over time.

At Beta, quality goes beyond a merely attentive industrial and sales policy, to permeate every company division, driving us all to achieve increasingly ambitious goals in terms of customer satisfaction. Beta has built its history on this very concept.

**Beta quality,
our most
concrete proof**

**The quality of Beta tools
is a synergy
of age-old techniques
and new technologies.**



Since 1995 our production processes have complied with the ISO 9001 Quality System standards



WORK ORGANIZATION

5S is a workplace organization method of Japanese origin. The name is derived from the western transcription of 5 Japanese words: **seiri, seiton, seiso, seiketsu and shitsuke**.

Following the 5 steps identified by the words allows a systematic, repeatable method to be implemented with a view to optimized working standards and enhanced operating performance.



SEIRI

SORT

Remove all unnecessary items from the workplace; only keep the items you need.



SEITON

SET IN ORDER

Put everything into its proper place: a place for everything and everything in its place.



SEISO

SHINE

Keep the workplace clean and tidy.



SEIKETSU

STANDARDIZE

Establish consistent work practices to keep rationalizing resources and spaces, determining a standard to implement.



SHITSUKE

SUSTAIN

Support and spread this mindset and behaviour across the organization.



BENEFITS



Reduced time loss and improved cost-effectiveness



Enhanced quality and productivity



Fewer work accidents



Greater efficiency



BEFORE



AFTER

EFFECTIVE PRESENCE

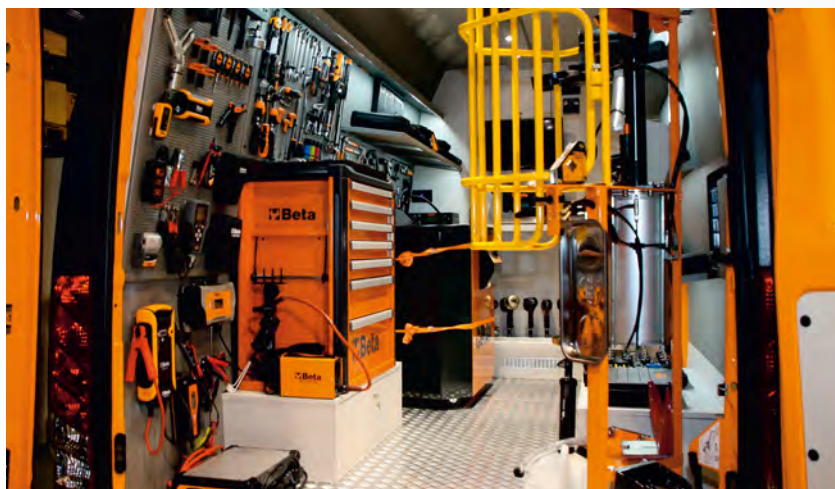
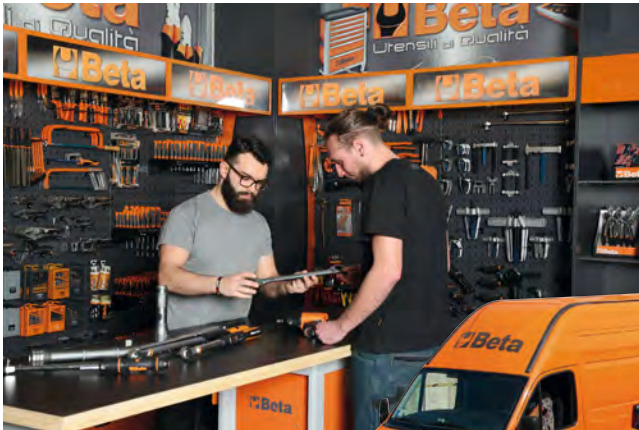

**Demonstration
unit
2021**

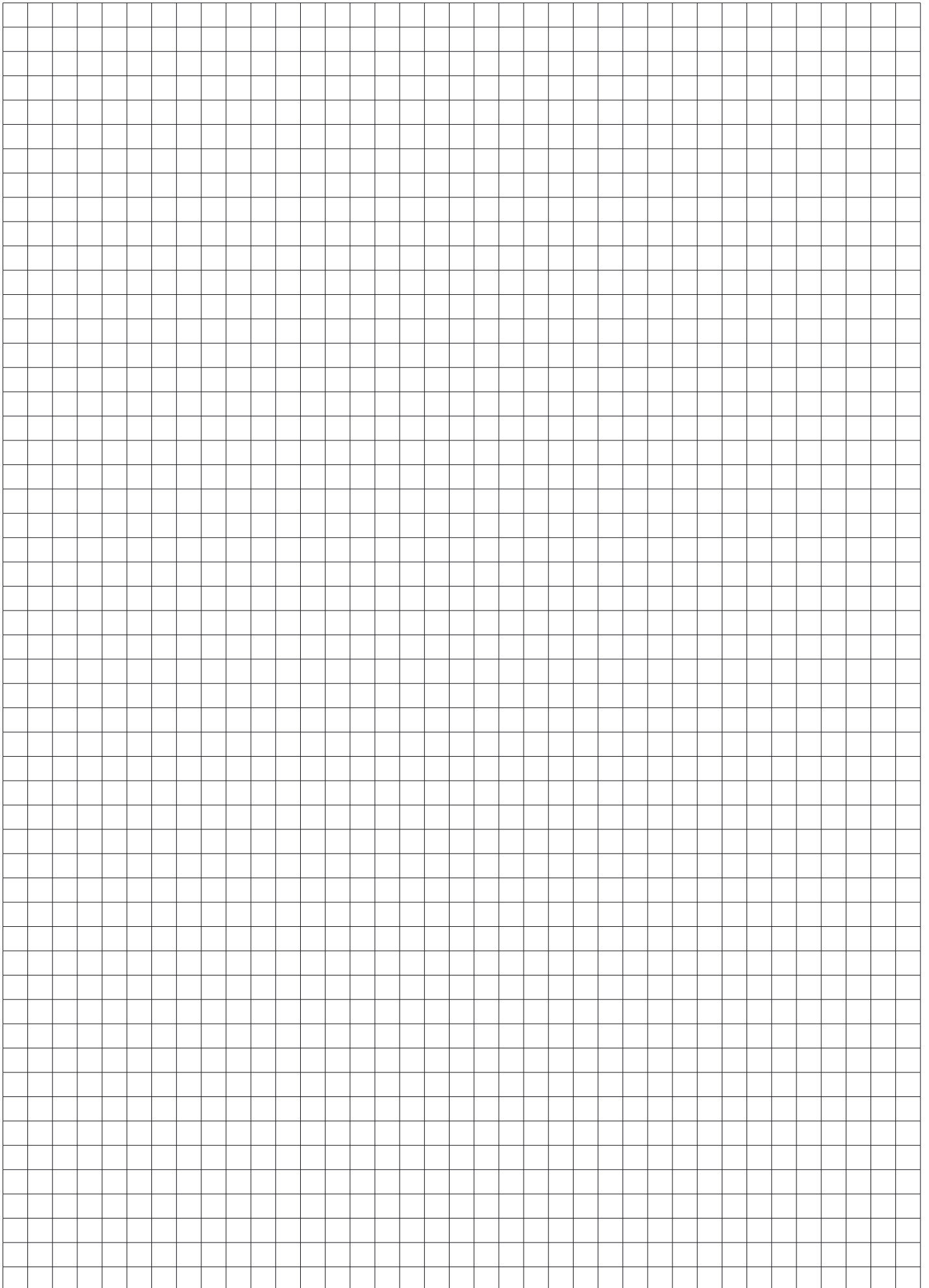

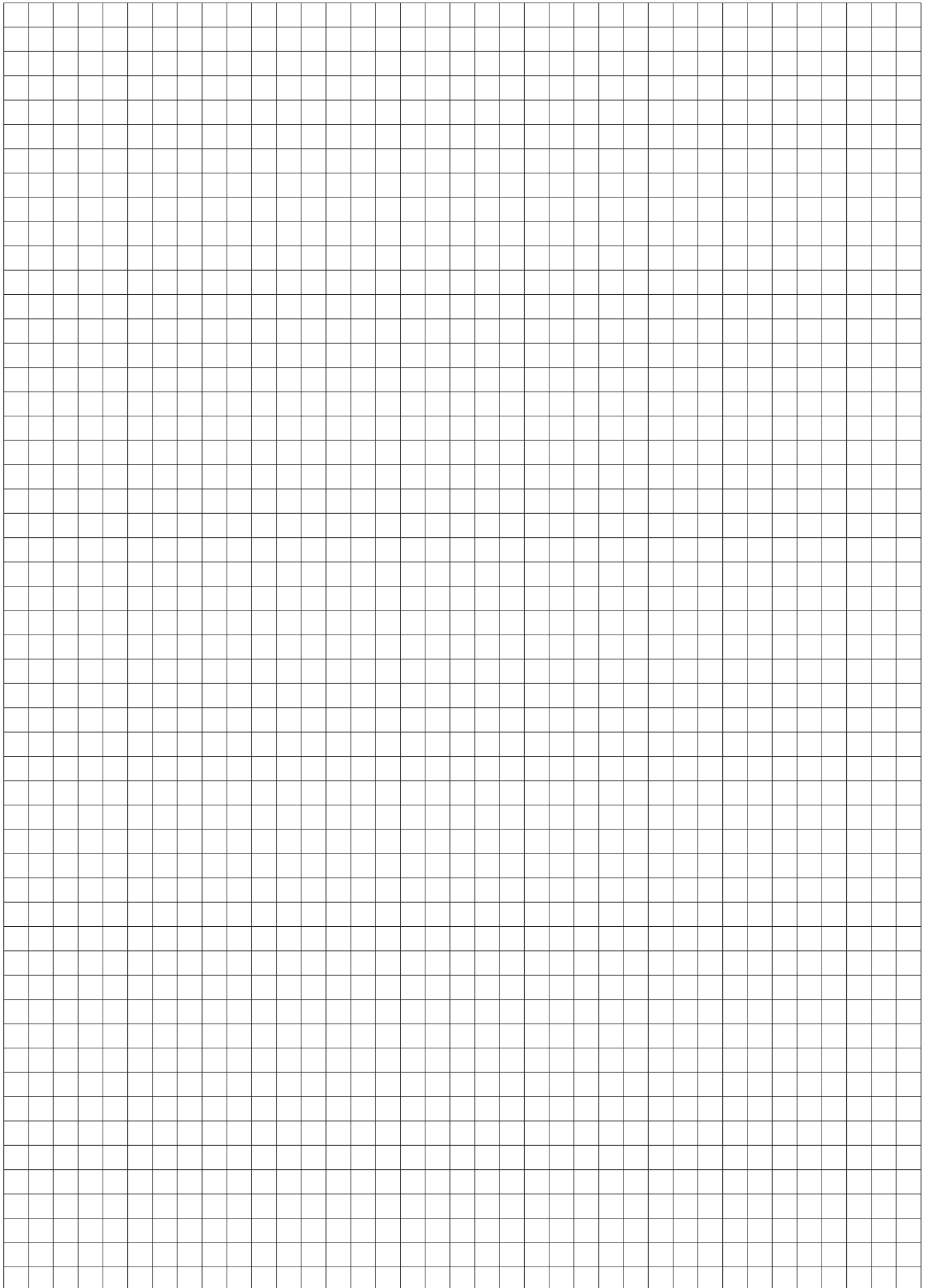

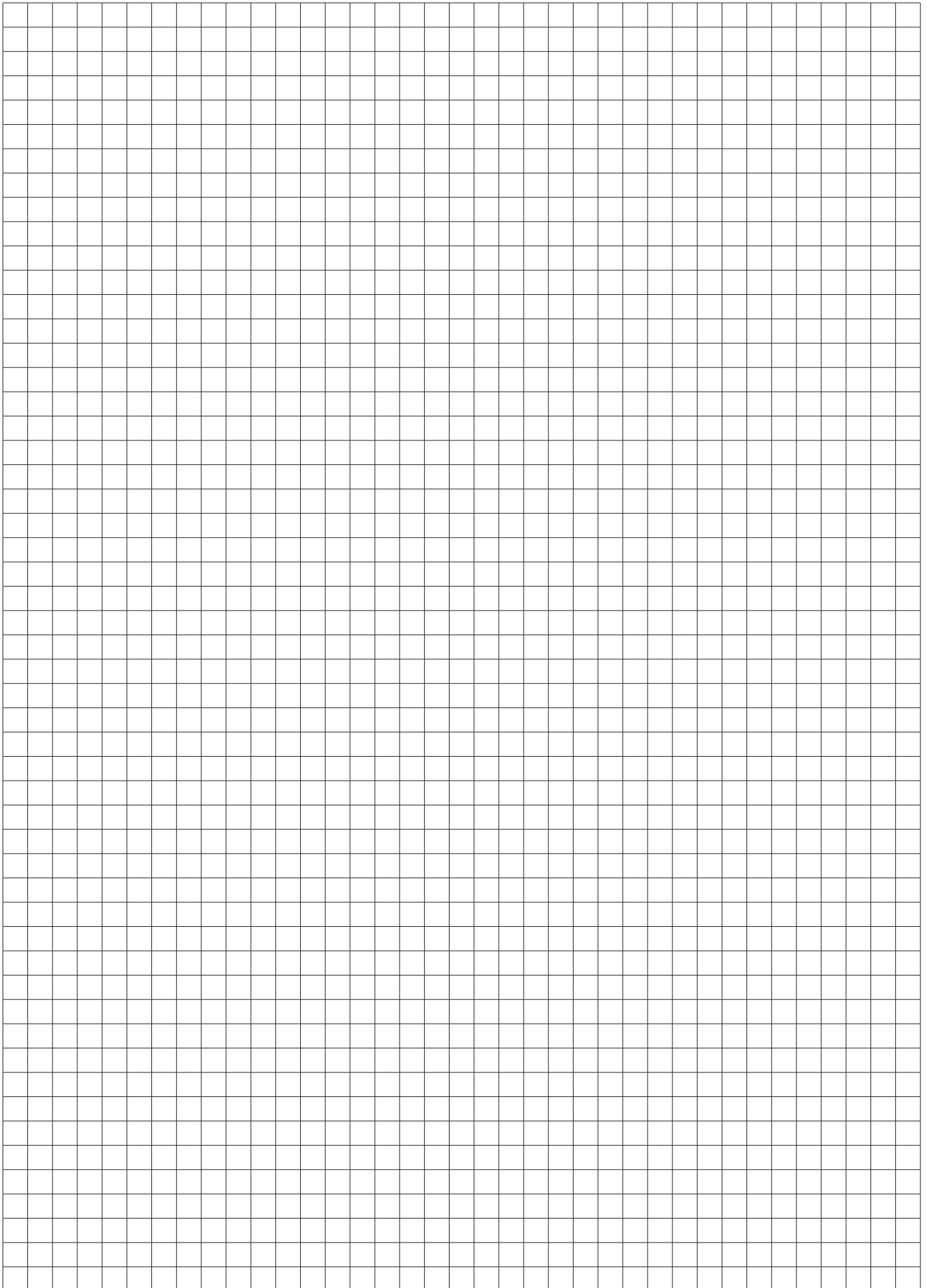

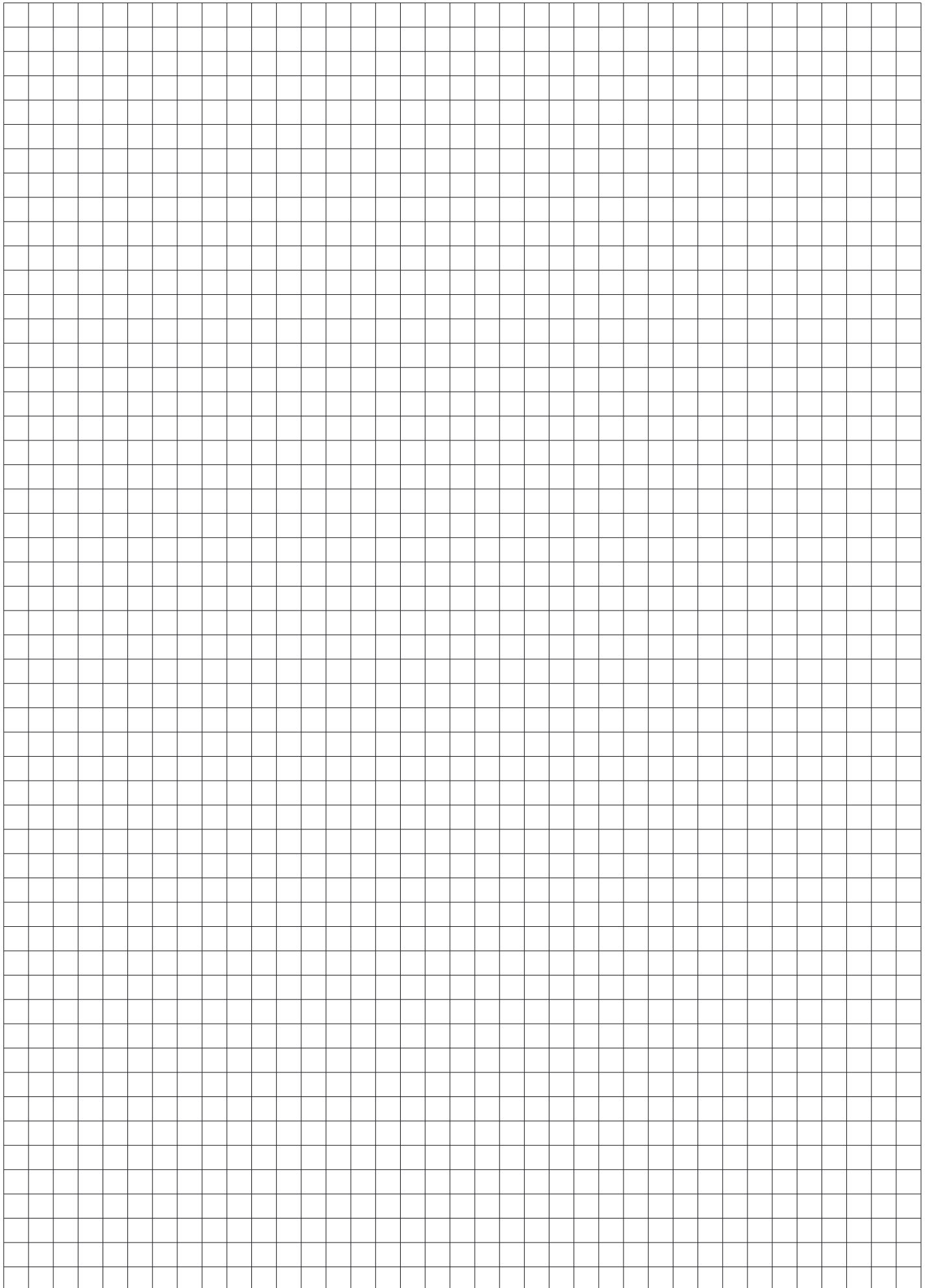

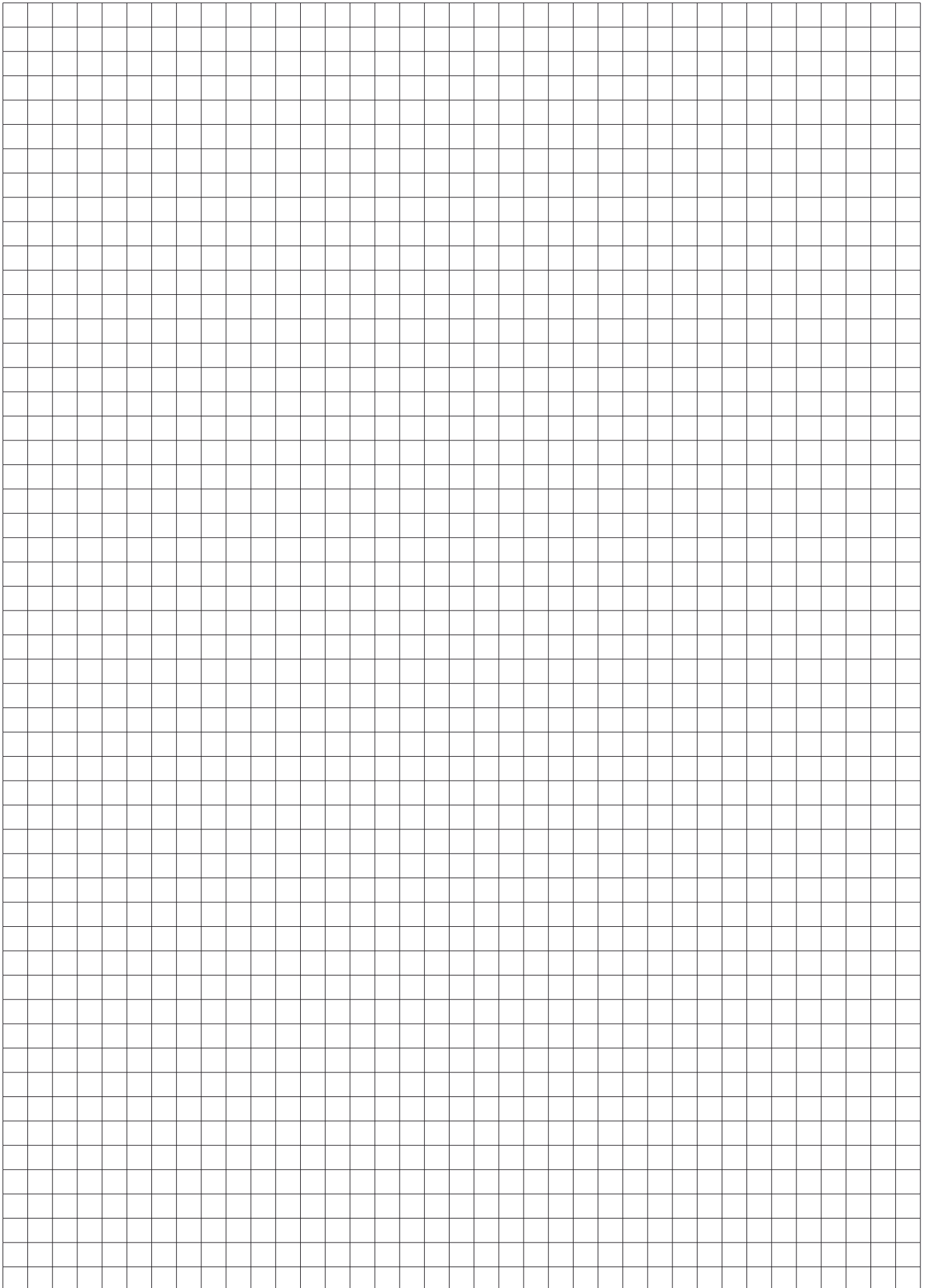

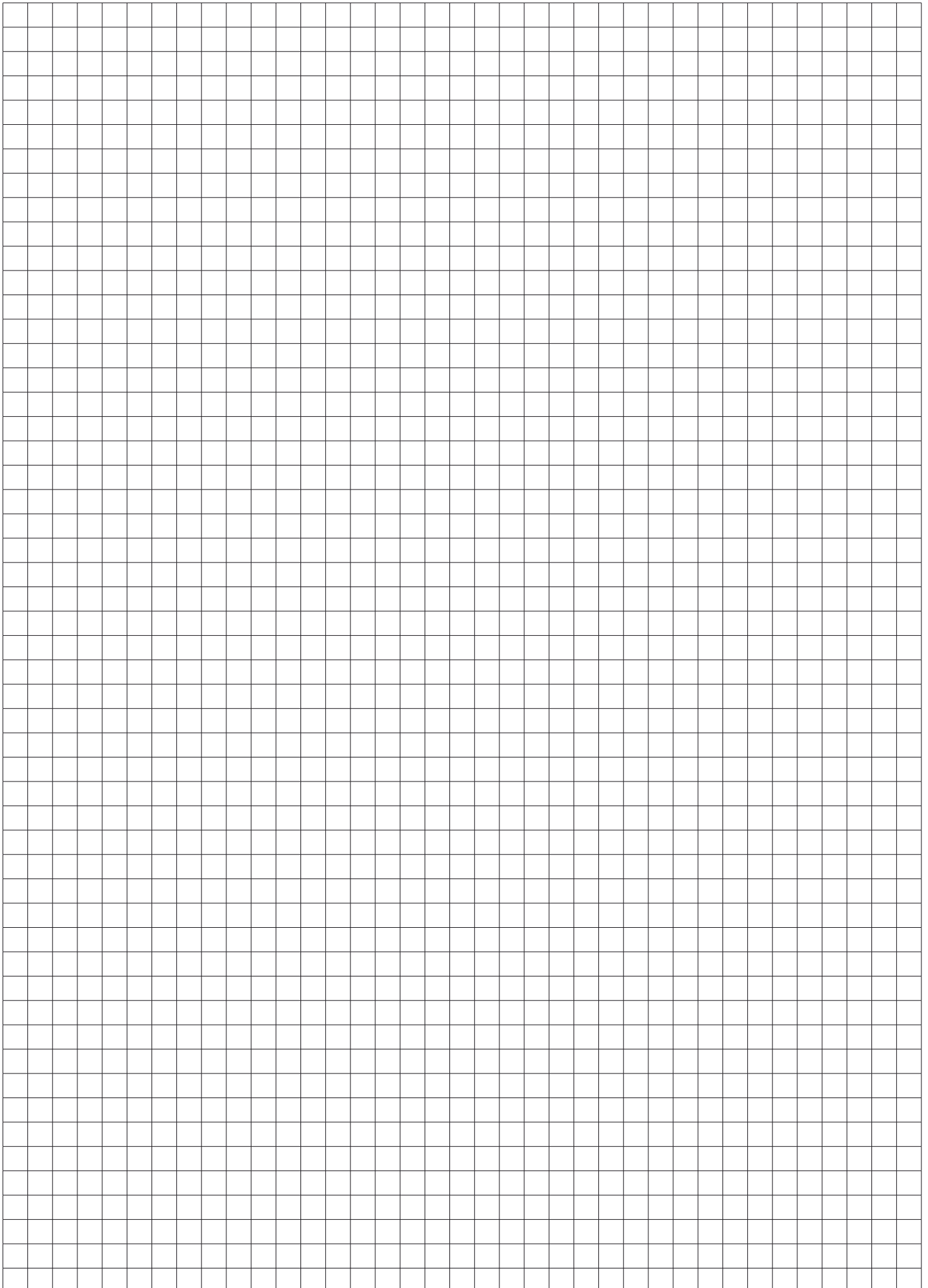

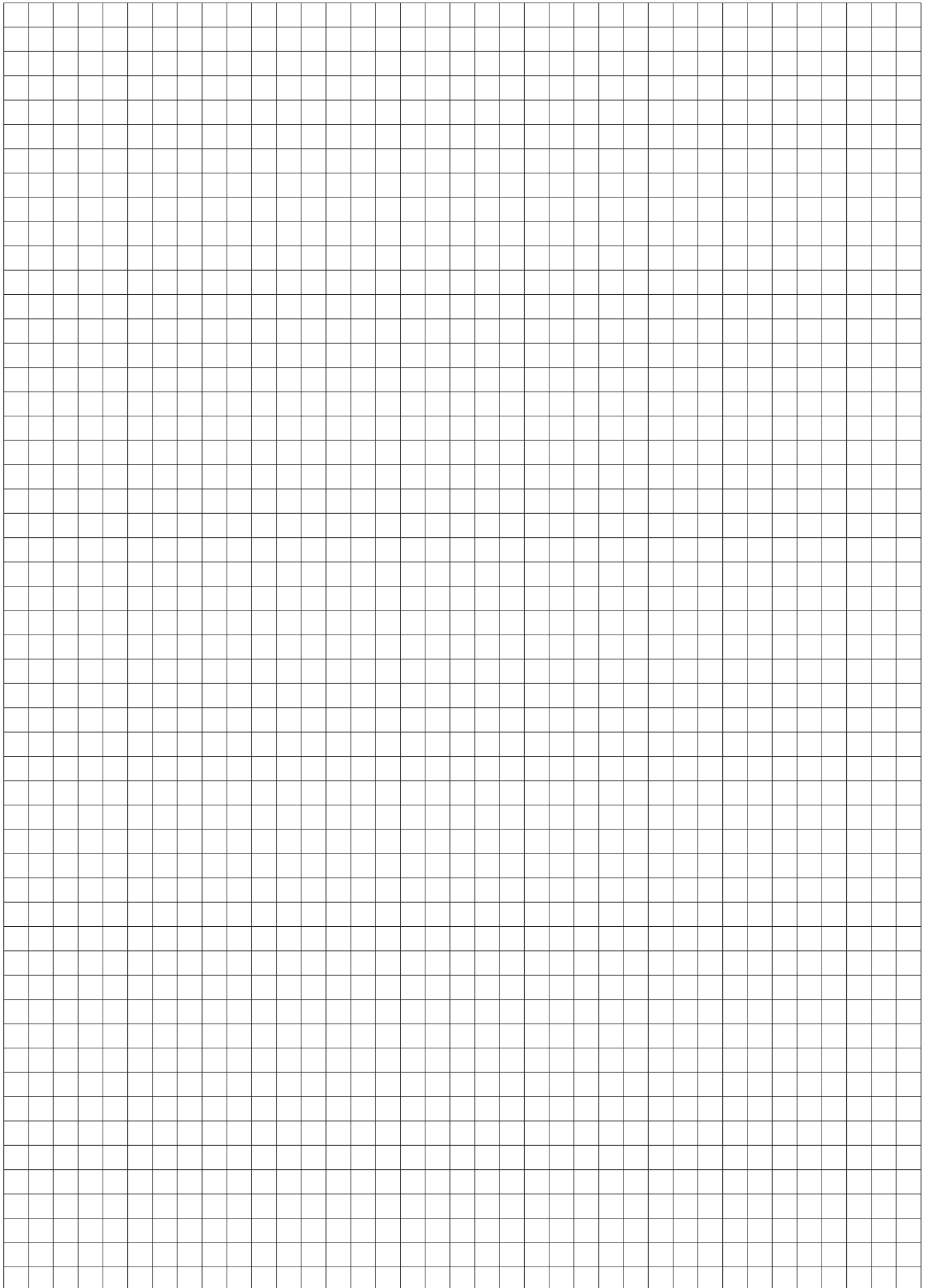

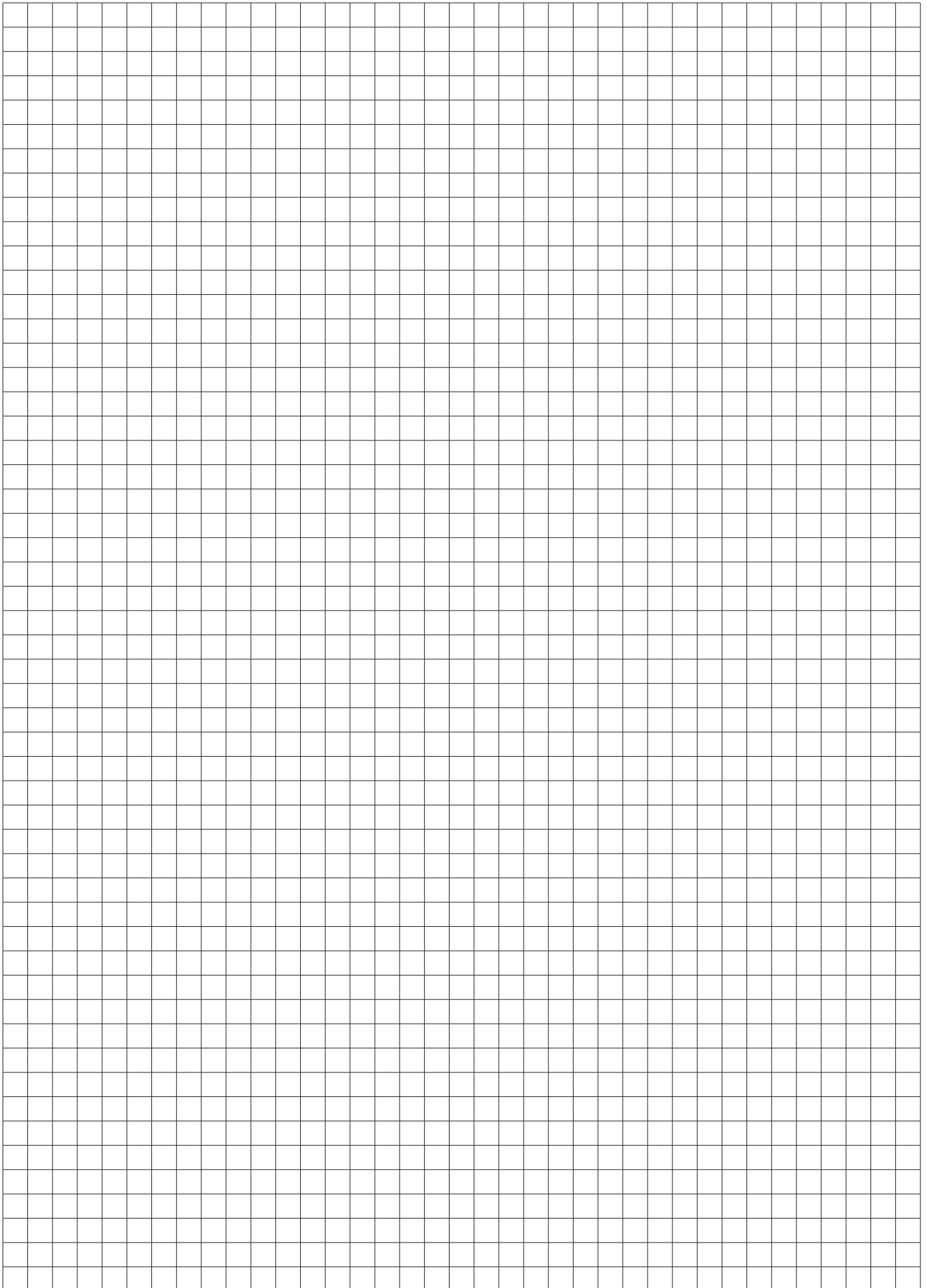

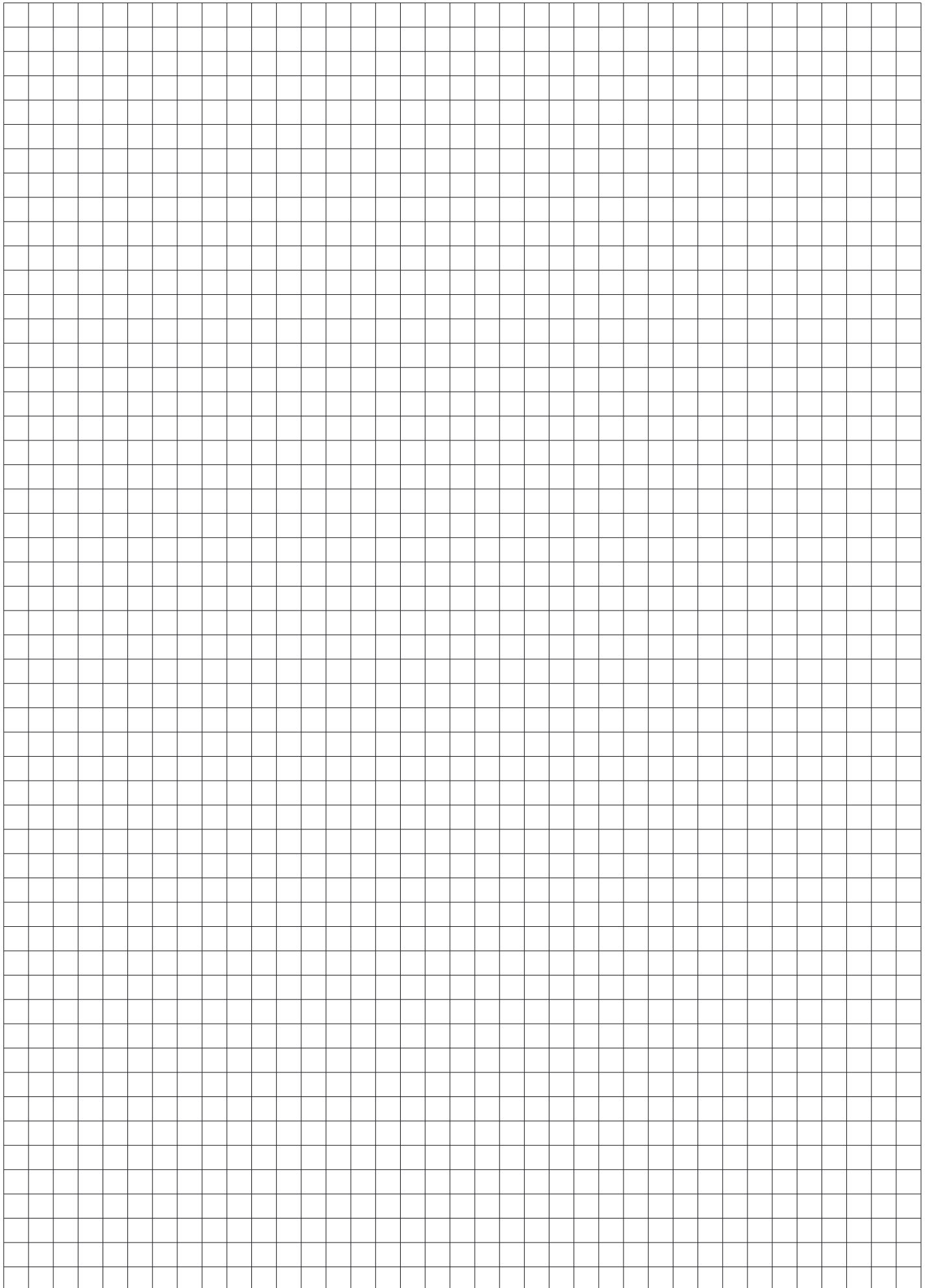

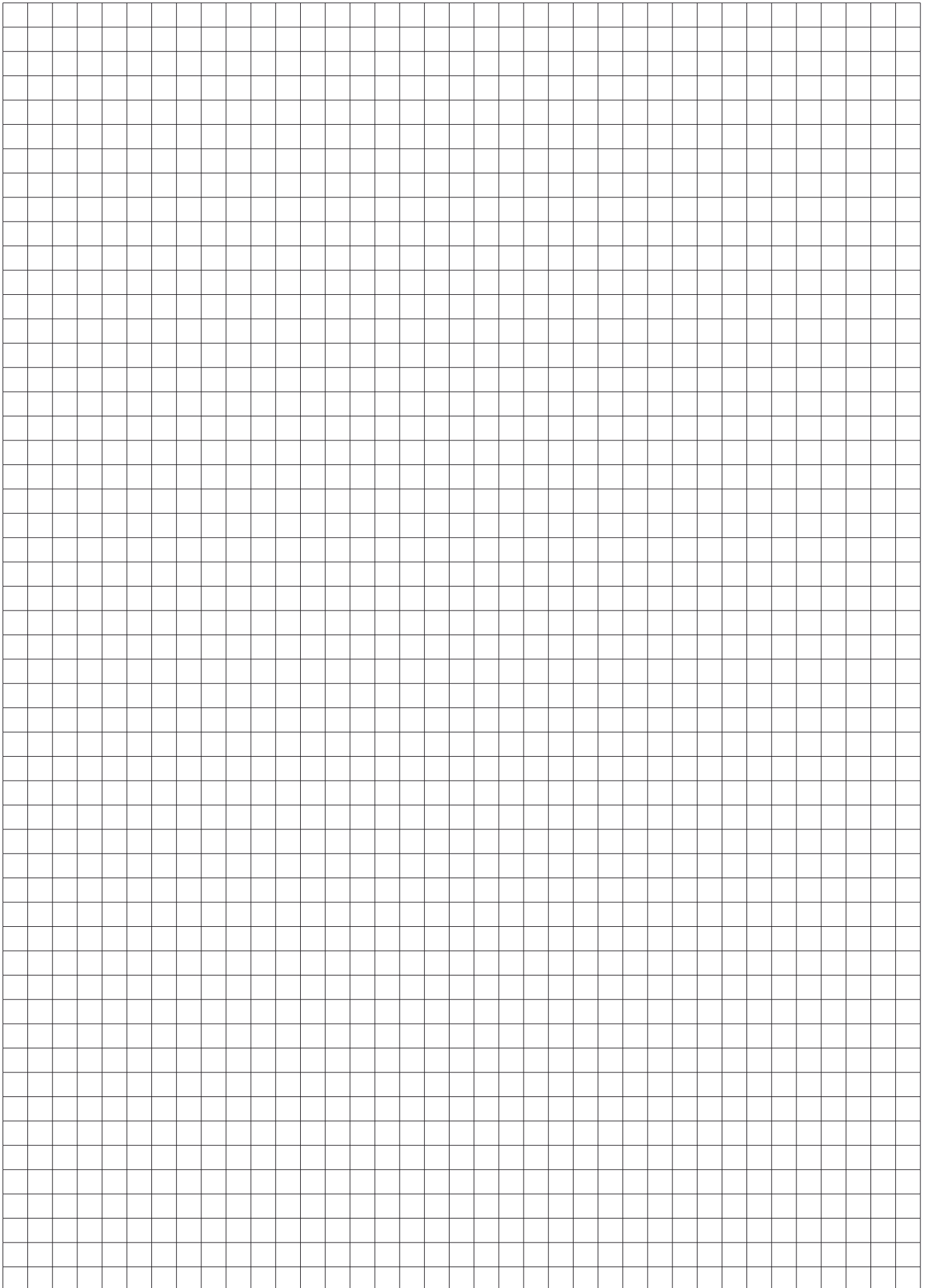

 **Beta**
RSC24

RS
K
E
L
S
R



Sam Lowes
Moto2 World Championship



Technical Partner



PEARL
NEVER
STOP



www.beta-tools.com